

90% Remedial Design Basis of Design Report

Appendix G

Geotechnical Design Analysis

---

## TABLE OF CONTENTS

<b>1</b>	<b>Introduction .....</b>	<b>1</b>
1.1	Locations Studied.....	1
1.2	Report Structure .....	1
<b>2</b>	<b>Subsurface Geotechnical Conditions .....</b>	<b>3</b>
2.1	Subsurface Stratigraphy.....	3
2.1.1	Fill .....	4
2.1.2	Recent Sediments.....	4
2.1.3	Alluvium .....	5
2.2	Groundwater and Surface Water Elevations.....	5
2.2.1	Groundwater .....	5
2.2.2	Surface Water.....	6
2.3	Soil Engineering Modeling Parameters.....	6
2.3.1	Undrained Shear Strength .....	7
2.3.2	Drained Shear Strength.....	7
2.3.3	Compressibility.....	8
<b>3</b>	<b>Geotechnical Engineering Analysis .....</b>	<b>9</b>
3.1	General Dredge Prism Side Slope Stability .....	9
3.1.1	Limit Equilibrium Model Background.....	9
3.1.2	Limit Equilibrium Model Development.....	10
3.1.3	Limit Equilibrium Method Model Results.....	10
3.1.4	Alternative Method Model Background, Development, and Results.....	12
3.2	Bank Excavation Slope Stability .....	12
3.2.1	General Bank Slope Stability Considerations.....	12
3.2.2	Terminal 117.....	13
3.2.3	Container Properties (RAA 27) .....	13
3.3	Cap Geotechnical Design Evaluation.....	14
3.3.1	Bearing Capacity .....	15
3.3.2	Subgrade Consolidation Settlement.....	17
3.3.3	Static Slope Stability of Caps .....	19
3.4	Backfill Design .....	20
3.4.1	Backfill Gradation .....	20
3.4.2	Backfill Stability .....	20

<b>4</b>	<b>Geotechnical Engineering Recommendations to Support Structural Engineering Evaluations.....</b>	<b>22</b>
4.1	Vertical Structure Evaluation Geotechnical Recommendations.....	22
4.1.1	Lateral Earth Pressures for Shoreline Structures .....	22
4.1.2	Effect of Prohibiting Surcharge Loads Above Bulkheads During Adjacent Dredging.....	23
4.1.3	Effect of Dredging on Passive Pressure .....	25
4.2	Pile Design Recommendations .....	27
<b>5</b>	<b>Seismic Design.....</b>	<b>28</b>
5.1	Seismic Site Class .....	28
5.2	Strong Motion Design Input Parameters.....	28
5.3	Liquefaction Evaluation.....	29
5.4	Seismic Performance of Capped Slopes.....	29
5.5	Conclusions on Seismic Performance of Sediment Remedy.....	30
<b>6</b>	<b>References .....</b>	<b>31</b>

## TABLES

Table G2-1	Summary of Selected Groundwater Levels for Exploration Locations Adjacent to the LDW .....	6
Table G2-2	Soil Parameters for Slope Stability Analysis of Dredge Prism Side Slopes.....	7
Table G3-1	Limit Equilibrium Method Factors of Safety Summary for Dredge Cut Slope Stability.....	11
Table G3-2	Slope Stability Comparison – Alternative Method and Limit Equilibrium Method Solutions.....	12
Table G3-3	Slope Stability Results – T-117 .....	13
Table G3-4	Slope Stability Results – Container Properties (RAA 27).....	14
Table G3-5	Subgrade Consolidation Modeling Scenarios.....	18
Table G3-6	Subgrade Consolidation Summary .....	18
Table G3-7	Backfill Gradation Specifications.....	20
Table G4-1	Bulkhead Lateral Earth Pressure Parameters.....	23
Table G4-2	Passive Earth Pressure Reduction Factors .....	26
Table G4-3	L-PILE Modeling Parameters .....	27
Table G5-1	Earthquake Parameters used in Geotechnical Engineering Evaluations.....	29
Table G5-2	Seismic Slope Displacement for Container Properties (RAA 27) Cap.....	30

## FIGURES

Figure G1-1a	Phase II PDI Geotechnical Data Locations, RMs 3.0 to 4.0
Figure G1-1b	Phase II PDI Geotechnical Data Locations, RMs 4.0 to 5.0
Figure G2-1	Undrained Shear Strength Test Results and Design Assumptions
Figure G3-1	Slope Stability – Short Term and Long Term Offshore of T-117
Figure G3-2	Container Properties Slope Stability Results – Long Term
Figure G4-1	Lateral Earth Pressures
Figure G5-1	Seismic Performance of Caps on Slopes – Container Properties 100-Year Event

## ATTACHMENTS

Attachment G.1	Subsurface Investigation Program and Field Logs
Attachment G.2	Geotechnical Laboratory Testing
Attachment G.3	Supplemental Geotechnical Information by Others
Attachment G.4	Calculations

## ABBREVIATIONS

ARCS	Assessment and Remediation of Contaminated Sediments
BODR	<i>Basis of Design Report</i>
CPT	cone penetrometer test
CR	compression ratio
DER	<i>Pre-Design Investigation Data Evaluation Report</i>
EAA	early action area
ENR	enhanced natural recovery
EPA	U.S. Environmental Protection Agency
FFP	full-flow penetrometer
FNC	federal navigation channel
ft <sup>2</sup>	square foot
GWT	groundwater table elevation
H:V	horizontal to vertical
kip	one thousand pounds
lb/ft	pounds per foot
LDW	Lower Duwamish Waterway
LTMMP	Long-Term Maintenance and Monitoring Plan
MHHW	mean higher high water
MLLW	mean lower low water
N/A	not applicable
pcf	pounds per cubic foot
pci	pounds per cubic inch
PDI	pre-design investigation
PGA	peak ground acceleration
psf	pounds per square foot
RAL	remedial action level
RD	remedial design
RM	river mile
ROD	<i>Record of Decision</i>
SPT	standard penetration test
T-117	Terminal 117
USACE	U.S. Army Corps of Engineers
USGS	U.S. Geological Survey
VST	vane shear testing

# 1 Introduction

This *Geotechnical Design Analysis* presents the results of the geotechnical engineering evaluation performed by Anchor QEA, LLC, to determine the basis of design for the upper reach (river miles [RMs] 3.0 to 5.0) of the Lower Duwamish Waterway (LDW) Superfund Site in King County, Washington. The remedial actions associated with the upper reach include dredging and capping of areas within the waterway, including areas that have waterfront or overwater structures; placing thin cover of clean material for enhanced natural recovery (ENR); and backfilling dredge areas within elevation ranges that support habitat as described in the Pre-Final (90%) Remedial Design (RD) *Basis of Design Report* (BODR) to which this *Geotechnical Design Analysis* is an appendix.

## 1.1 Locations Studied

The proposed work requires remediation within the actively managed federal navigation channel (FNC), areas adjacent to waterfront and offshore structures, and early action areas (EAAs) over a range of subtidal and intertidal elevations. Subtidal areas are defined as areas below elevation -4 feet mean lower low water (MLLW). Intertidal areas represent elevations between -4 feet MLLW and the mean higher high water line (MHHW; equal to +11.4 feet MLLW), which horizontally defines the limit of sediment cleanup actions in the upper reach. The MHHW line occurs along sloped embankments or vertical bulkheads. Upland areas are locations above MHHW that abut and include shoreline property where buildings and structures may be encountered.

## 1.2 Report Structure

This *Geotechnical Design Analysis* includes the following six main sections:

- Section 1 is the introduction.
- Section 2 discusses the subsurface conditions underlying the site in more detail than presented in the *Pre-Design Investigation Data Evaluation Report* (DER) (Anchor QEA and Windward 2022); this section also describes the soil engineering parameters assigned to the major stratigraphic units.
- Section 3 describes the geotechnical engineering analyses performed for each of the following design elements:
  - Dredge prism side slope stability
  - Bank side slope stability
  - Cap bearing capacity and settlement evaluations
  - Backfill design
- Section 4 presents geotechnical engineering recommendations to be used by the structural engineer for the assessment of the following:
  - Bulkhead design, including lateral earth pressures and tieback design soil parameters
  - Pile design, including vertical and lateral pile capacity

- Section 5 discusses seismic (earthquake) evaluations for the site.
- Section 6 presents references that were used to support this work.

Attachments to this *Geotechnical Design Analysis* include the following:

- Attachment G.1 – Subsurface Investigation Program and Field Logs
- Attachment G.2 – Geotechnical Laboratory Testing
- Attachment G.3 – Supplemental Geotechnical Information by Others
- Attachment G.4 – Calculations

## 2 Subsurface Geotechnical Conditions

Subsurface geotechnical conditions at the site were investigated by Anchor QEA to supplement the existing geotechnical information that was collected during past projects in the vicinity of the upper reach. Details regarding these prior investigations can be found in the DER (Anchor QEA and Windward 2022).

Subsurface geotechnical conditions in the upper reach of the LDW were investigated by Anchor QEA as part of the Phase I and Phase II pre-design investigation (PDI) efforts completed in 2021 and 2022. The geotechnical PDI included the following numbers and types of geotechnical investigations, which were advanced to a range of depths below ground surface:

- 29 rotosonic borings
- 20 cone penetrometer tests (CPTs)
- 5 vane shear tests (VSTs)
- 7 full-flow penetrometer (FFP) tests
- 2 hand auger borings
- 2 dynamic CPTs

The locations of these geotechnical investigations are presented in Figures G1-1a and G1-1b. Logs from these investigations are presented in Attachment G.1, and geotechnical laboratory testing results are presented in Attachment G.2.

The scope of the geotechnical PDI was developed considering existing geotechnical information within the upper reach. Studies by others provide supplemental subsurface geotechnical data in upland areas adjacent to the upper reach and at in-water locations. Attachment G.3 presents the locations with supplemental geotechnical information and lists the studies that have been identified as providing useful subsurface geotechnical data in the upper reach.

The following sections provide a more comprehensive discussion of subsurface conditions encountered at the site than is presented in the DER.

### 2.1 Subsurface Stratigraphy

Pre-Final (90%) RD BODR Section 8.2 summarizes the stratigraphy. The following section provides more detailed information on the geotechnical properties for the three major stratigraphic units described in the DER (Anchor QEA and Windward 2022) and the Pre-Final (90%) RD BODR for the purposes of geotechnical engineering design and analysis later described in this report.



### 2.1.1 *Fill*

Fill soils were encountered at two locations during the Phase II PDI and at several other upland locations investigated by others. The specific geologic interpretation of fill is indicated on historical boring logs from Boeing Plant 2, both the east and west banks at the South Park Bridge, and at several properties that are not adjacent to remedial action level (RAL) exceedance areas (e.g., near RM 3.0 west and between RMs 3.5 and 3.6 west at Terminal 117 [T-117]). Given the river history of channelization, fill is likely present along many banks of the upper reach that have not been geotechnically investigated.

Generally, the fill material had been placed to regrade the existing fluvial plain created by the Duwamish River to support shoreline development and re-channelization of the LDW. The unit weight of this material is assumed to vary, but, to prepare design recommendations, the material is assumed to be conservatively represented by an overall average value of 135 pounds per cubic foot (pcf) based on laboratory direct shear test results. Grain size distribution tests show that this material is predominately sand with varying amounts of silt. In areas where fill was more randomly placed, it would be expected to contain anthropogenic materials such as debris, which would be typical of historical shoreline development filling activities in active industrial areas. The moisture content in the fill unit generally ranges from 6% to 28%. Direct shear testing of the fill indicates a peak friction angle average of 36 degrees and a residual friction angle average of 33 degrees.

The findings associated with the two upland borings completed in 2021 are in general agreement with historical investigations completed by others.

### 2.1.2 *Recent Sediments*

Recent sediments are defined as material that has deposited on top of the alluvium layer and are distinctly characterized by finer gradation and soft consistency compared to the alluvium layer below. Recent sediments were encountered throughout the intertidal and subtidal areas, having been naturally deposited by flows to the LDW upper reach from Green River upstream. The thickness of this unit across the site varies widely and is observed to be thickest in areas of historical dredge activities in the FNC and Slip 6.

Based on a review of laboratory testing results, a total unit weight of 100 pcf was assumed to best represent average overall conditions, with percent moisture content ranging from 34% to 97%. Atterberg limits (plasticity) testing indicates that this material is typically non-plastic to very low plasticity, an indication that the finer fractions are predominantly silt rather than clay. Direct shear testing indicates a peak friction angle of 34 degrees for the recent sediments and a residual friction angle of 33 degrees, whereas VST and FFP testing indicate undrained shear strengths ranging as shown in Figure G2-1. Grain size analyses indicate that this material is approximately 30% sand and 70% silt and clay, with silt content ranging from 22% to 62% and clay content ranging from 2% to 7%.

### 2.1.3 Alluvium

Investigations prior to the PDI describe the alluvium by referencing an upper alluvium unit and a lower alluvium unit. Because the distinction between the upper alluvium and lower alluvium is not important in the context of the sediment cleanup, in the DER, the description of the alluvium was simplified by combining the upper alluvium and lower alluvium into a single alluvium unit, recognizing that there are some gradational changes in the alluvium with depth (Anchor QEA and Windward 2022). Alluvium was observed to underly the recent sediments and be predominately coarse-grained material with pockets, lenses, and layers of silt and clay. Silt content of the fine-grained layers was as high as 76%, and clay content was as high as 16%; silt and clay content was observed to be as low as 1.5%. The alluvium unit has a typical specific gravity of 2.5 to 2.7; is non-plastic; and has a typical total unit weight of 125 pcf, a measured peak friction angle ranging from 32 to 40 degrees (average 37 degrees), and a measured residual friction angle ranging from 28 to 37 degrees (average 32 degrees).

## 2.2 Groundwater and Surface Water Elevations

Groundwater and surface water affect the geotechnical behavior of soils and sediments. Water surface elevations are used in geotechnical engineering evaluations to calculate porewater pressures and effective stresses, which govern the shear strength of soils. Changes in effective stress (which occur due to changes in porewater pressure) also lead to consolidation settlement. Thus, water surface elevations are a key input parameter for geotechnical engineering evaluations. This section summarizes general observations of groundwater and surface water levels made during the geotechnical investigation and as summarized in other reports.

### 2.2.1 Groundwater

Groundwater has been observed in shoreline groundwater wells along the upper reach. At locations nearest the LDW, groundwater elevations vary regularly in accordance with the water level in the river. Farther from the shoreline, groundwater levels are less affected by the adjacent surface water level but are still expected to vary seasonally. Table G2-1 summarizes typically observed groundwater levels at selected locations along the upper reach for exploration locations adjacent to the LDW, which are used as a basis for geotechnical engineering evaluations described in this report.

**Table G2-1**  
**Summary of Selected Groundwater Levels for Exploration Locations Adjacent to the LDW**

Location	River Mile	Observed Groundwater Elevation Range (feet above MLLW)	Observed Depth to Groundwater Range Below Ground Surface (feet)	Reference
Boeing Plant 2	2.9 E	7 to 11	6 to 11.5	AMEC 2012
Boeing Isaacson Thompson	3.8 E	3 to 10	11 to 17	Landau and AMEC 2014
T-117	3.6 W	8 to 10	3 to 20	GeoEngineers 2014
Dallas Avenue Drainage Project	3.6 W	8	10	SPU 2014
Delta Boat Lift	4.2 W	8	7	AMEC 2002
SPU Duwamish Substation	4.5 W	6 to 8	10 to 12	SPU 2012

Note:  
LDW: Lower Duwamish Waterway  
MLLW: mean lower low water  
SPU: Seattle Public Utilities  
T-117: Terminal 117

## 2.2.2 Surface Water

The upper reach is tidally influenced, and water levels are also affected by inflows from Green River upstream. Upstream inflows are controlled by the Howard Hansen Dam, so tidal influences tend to dominate the river stage (surface water elevation) on a daily basis. In the project vertical datum, the MHHW elevation is 11.3 feet, and the MLLW elevation is 0 foot.

## 2.3 Soil Engineering Modeling Parameters

This section summarizes the geotechnical engineering properties that were assigned to each lithologic unit for geotechnical evaluations. Engineering properties were derived using correlations to in situ CPT results, VST results, FFP test results, and geotechnical laboratory testing results. For cap aggregates, habitat materials, and backfill, engineering parameters were assigned using best professional judgment and from past project experience considering the location of placement (beneath the water surface) and the typical materials used for these applications (sand and gravel). Soil parameters are presented in Table G2-2.

**Table G2-2**  
**Soil Parameters for Slope Stability Analysis of Dredge Prism Side Slopes**

Soil Layer	Total Unit Weight (pcf)	Undrained Shear Strength <sup>1</sup>		Drained Shear Strength		Compressibility
		Cohesion (psf)	Internal Friction Angle, $\phi'$ (degrees)	Cohesion (psf)	Internal Friction Angle, $\phi'$ (degrees)	Compression Ratio (unitless)
Fill	135	N/A	N/A	0	33	See Note 2
Recent sediments	100	$10+38*Z$ ; $\leq 200$	0	0	27	0.17
Alluvium	125	$100+30*Z$ ; $\leq 1800$	0	0	32	0.09
Cap, habitat and backfill materials	110	N/A	N/A	0	32	See Note 2
Armor Rock	135	N/A	N/A	0	40	See Note 2

Notes:

1. Z = depth below top of layer surface elevation
2. The fill, cap, habitat, backfill, and armor rock materials, being primarily granular, were not considered compressible for purposes of consolidation calculations. See discussion of compressibility.

N/A: not applicable. See discussion of undrained shear strength (Section 2.3.1).

pcf: pounds per cubic foot

psf: pounds per square foot

### 2.3.1 Undrained Shear Strength

Undrained shear strength can be directly estimated from the tip resistance measured during advancement of the cone during CPT and FFP testing, allowing for a near-continuous relationship of undrained shear strength versus depth (Robertson and Cabal 2010). For the purposes of this report, undrained shear strength values were determined by inspection of the FFP test and VST results at each location. This inspection was completed by plotting undrained shear strength with depth.

Figure G2-1 presents the measured undrained shear strength with depth. Analysis of this plot shows that the undrained shear strength for the recent sediments, as well as for the compressible layers within the alluvium, increases linearly with depth. Thus, the design assumes undrained shear strength is variable, as presented in Table G2-2. Undrained shear strength is not relevant for cohesionless materials (e.g., sand and gravel), which rely on inter-particle friction to develop strength. Thus, the undrained shear strength for sand and gravel type materials (fill, cap, habitat, and backfill) is not applicable because these materials are not expected to behave in an undrained manner.

### 2.3.2 Drained Shear Strength

Drained shear strength applies to the long-term behavior of fine-grained materials and both the short- and long-term behavior of granular materials, which drain very rapidly under applied loads.

Drained shear strength can be correlated to in situ tests (e.g., standard penetration test blow counts, CPT records) and can be measured in laboratory geotechnical tests.

For this project, a series of direct shear tests was conducted on representative undisturbed samples from each major stratigraphic unit to evaluate drained shear strength behavior in terms of peak and residual friction angles. In general, average peak friction angles ranged from 34 to 37 degrees, and average residual friction angles ranged from 32 to 33 degrees.

Laboratory testing is conducted under ideal conditions and reflects assumed loading rates and drainage conditions that potentially will not apply under full-scale conditions. It is expected that actual soil behavior will be more variable and reflect inherent uncertainty that cannot be captured by laboratory testing alone. Thus, the laboratory test results were reviewed by an experienced geotechnical engineer, who applied engineering judgment to reduce the friction angle (drained shear strength) selected for design to reflect values more typically used regionally in engineering design. See Table G2-2 for a summary of friction angles that were selected for design for each major geologic unit.

### 2.3.3 Compressibility

Consolidation settlement (i.e., compression) occurs over time as new loads are applied to fine-grained soil or sediment and as water is driven out of the soil/sediment pore space due to the applied loading (i.e., drainage).

Compressibility parameters were assessed using the laboratory one-dimensional oedometer consolidation test. The test incrementally loads an undisturbed sample and measures the corresponding settlement, which is plotted as a relationship between stress (load) and strain (settlement). When stress is plotted in log scale and strain in natural scale, the resulting plot is generally linear over the range of virgin compression, and the slope of this line is referred to as the Compression Ratio. The Compression Ratio can be used to calculate anticipated consolidation under load.

Four oedometer tests were conducted: one in the recent sediment unit, two within the sandy alluvium, and one in the silty alluvium. The results of these tests were evaluated to develop the consolidation parameters summarized in Table G2-2.

The time rate of consolidation is affected by the distance that water must travel when drainage is occurring. Through inspection of the CPT porewater pressure profiles, a maximum drainage path ( $H_{dr}$ ) length of 3.5 feet was determined. Lastly, for the purposes of the analysis for this project, a design coefficient of consolidation of 0.08 square feet ( $ft^2$ ) per day was assumed.

## 3 Geotechnical Engineering Analysis

This section discusses the following geotechnical engineering analyses prepared in support of the RD:

- Dredge prism side slope stability
- Bank excavation slope stability
- Cap bearing capacity and settlement

### 3.1 General Dredge Prism Side Slope Stability

Dredge prism side slope stability was evaluated using limit equilibrium methods and confirmed using an alternate method. This section describes the evaluation of dredge prism side slope stability including the following:

- Limit equilibrium model background
- Limit equilibrium model development
- Limit equilibrium method model results
- Alternative method model background, development, and results

#### 3.1.1 *Limit Equilibrium Model Background*

The stability of dredge prism side slopes was evaluated using Rocscience Slide2 limit equilibrium software model. For a given evaluation, a geologic cross section was developed, and soil layers and soil geotechnical engineering parameters were input into the model.

The limit equilibrium model software calculates load (soil stress) and resistance (soil strength) for numerous trial “slip surface” geometries to generate a factor of safety for each trial slip surface. The slip surface with the lowest factor of safety is considered the “critical” slip surface for a particular stability cross section. Slip surfaces are generated using an automated search routine within the software so that an appropriate number of trial surfaces are checked when identifying the critical slip surface. The calculation method (General Limit Equilibrium) satisfies both force and moment equilibrium for each trial slip surface.

Acceptable (i.e., target) factors of safety are as follows, in accordance with a common U.S. Army Corps of Engineers (USACE) reference for slope stability (USACE 2003):

- Short-term – 1.3 or greater
- Long-term – 1.5 or greater
- Rapid drawdown – 1.3 or greater

The short-term case represents conditions during construction (e.g., for a temporary dredge cut slope prior to backfilling). The long-term case represents conditions once construction is complete (e.g., for backfilled slopes) and soils/sediments have equilibrated to the stress conditions associated with the post-construction slope geometry.

The rapid drawdown condition represents a stability case where changes in water levels along shoreline banks occur when the tide is receding, but adjacent upland water levels have not equilibrated to river water levels. A range (1.1 to 1.3) of acceptable factors of safety is published for the rapid drawdown case in USACE (2003). The high end of the range (1.3) was selected for this evaluation because upland water surface elevations are considered to be more akin to the maximum storage pool case than the maximum surcharge pool case.

### 3.1.2 *Limit Equilibrium Model Development*

An assumed dredge cut slope and sediment properties (Table G2-2) were input to the limit equilibrium model, and a search routine was run by the software to locate the critical slip surface. Table G3-1 summarizes the factors of safety calculated in this evaluation.

Stability was evaluated for existing slopes and a range of potential dredge slopes for both short-term (undrained) and long-term (drained) conditions.

Based on bathymetric survey conducted during the PDI, the natural angles of the subtidal to nearshore slopes range from 4 horizontal to 1 vertical (4H:1V) to 17.5H:1V.

The limit equilibrium slope stability evaluation was conducted for two different assumed slope cut angles (2H:1V and 3H:1V) and assuming water levels that correspond to both intertidal and subtidal slopes. For the subtidal evaluation, the dredge cut slope was assumed to be entirely submerged. For the intertidal evaluation, the water level was assumed to be 2 feet below the top of the dredge cut slope.

For the rapid drawdown evaluation, it was assumed that the top of the slope on the upland side of the dredge cut would be fully submerged, and a low tide condition (water level 0 feet MLLW) was assumed on the river side of the dredge cut. It was also assumed the slope itself would not drain during the tidal cycle; thus, undrained shear strength parameters were assumed for the dredge cut slope. The rapid drawdown condition was assessed for intertidal slopes only, where water levels within the slope would be changing. For submerged slopes, the dredge cut would be sufficiently distant from the influence of upland water levels to affect the slope stability factor of safety during changing tides.

### 3.1.3 *Limit Equilibrium Method Model Results*

Table G3-1 summarizes the results of the dredge cut slope stability evaluation for the short-term, long-term, and rapid drawdown cases.

**Table G3-1  
Limit Equilibrium Method Factors of Safety Summary for Dredge Cut Slope Stability**

Dredge Cut Thickness (feet)	Scenario	Target Factor of Safety	Side Slope	Factor of Safety	
				Subtidal Slope <sup>1</sup>	Intertidal Slope <sup>2</sup>
5	Short-term	1.3	2H:1V	4.2	2.1
			3H:1V	5.3	2.5
	Long-term	1.5	2H:1V	1.1	N/A
			3H:1V	1.6	N/A
	Rapid drawdown	1.3	2H:1V	N/A	2.1
			3H:1V	N/A	2.5
7	Short-term	1.3	2H:1V	4.5	2.4
			3H:1V	5.0	2.6
	Long-term	1.5	2H:1V	1.0	N/A
			3H:1V	1.6	N/A
	Rapid drawdown	1.3	2H:1V	N/A	2.4
			3H:1V	N/A	2.6

Notes:

1. The rapid drawdown case does not change conditions for the subtidal slopes because all water surfaces are above the submerged slope and the submerged slope is sufficiently distant from the influence of upland water surface conditions; thus, there is no need for a rapid drawdown evaluation of subtidal slopes created by dredging.
2. Intertidal dredge areas will be backfilled in the long-term condition in accordance with the ROD (EPA 2014); thus, there is no long-term intertidal slope condition created by dredging.

H:V: horizontal to vertical (ratio)

N/A: not applicable

ROD: Record of Decision

In the short-term condition (i.e., during construction), temporary cut slopes of 2H:1V meet the target factor of safety in both subtidal and intertidal areas.

Long-term slopes constructed at 2H:1V do not meet target factors of safety for subtidal dredged slopes. Long-term subtidal slopes constructed at 3H:1V do meet target factors of safety. In intertidal areas, dredge cut slopes will be backfilled, so there is no need to assess long-term dredge cut stability in these areas.

Conclusions for the rapid drawdown stability assessment are the same as the short-term stability assessment.



Based on the slope stability evaluation, short-term dredge cut slopes of 2H:1V can be used for the temporary scenario prior to backfilling. For long-term dredge cut slopes (i.e., areas that will not be backfilled), 3H:1V slopes should be used.

### 3.1.4 Alternative Method Model Background, Development, and Results

As required by the U.S. Environmental Protection Agency (EPA), the conclusions of the limit equilibrium modeling method were checked using an alternative method of assessment—specifically slope stability chart solutions, as presented in USACE (2003) Appendix E.

Table G3-2 compares the chart solutions with the limit equilibrium solutions (Table G3-1) for the short-term (undrained) case and a 5-foot-deep dredge cut. As demonstrated by Table G3-2, the limit equilibrium method used provides a more conservative result; therefore, it is being carried forward as the appropriate tool for assessing slope stability. Attachment G.4 provides a copy of the hand calculations.

**Table G3-2**  
**Slope Stability Comparison – Alternative Method and Limit Equilibrium Method Solutions**

Case	Alternative Method (Chart Solution) Factor of Safety	Limit Equilibrium Method Solution Factor of Safety (Table G3-1)
2H:1V Slope – 5-foot cut depth Subtidal	6.5	4.2
2H:1V Slope – 5-foot cut depth Intertidal	3.6	2.1
3H:1V Slope – 5-foot cut depth Subtidal	8.5	5.3
3H:1V Slope – 5-foot cut depth Intertidal	4.7	2.5

Notes:  
Comparison for short term (undrained) evaluations  
H:V: horizontal to vertical (ratio)

## 3.2 Bank Excavation Slope Stability

### 3.2.1 General Bank Slope Stability Considerations

In most locations along the banks of the upper reach, bank excavations will require removal of surficial soils or sediment. Where excavations on banks are on the order of 1 to 2 feet deep, the evaluation of bank excavation slope stability is not warranted because removal of thin cuts will not materially affect the stability of the bank itself. Experience conducting similar work on other shoreline

projects has demonstrated that minor bank excavations (1 to 2 feet deep) can be accomplished without causing slope stability problems.

Bank slope stability is a key consideration for areas where deeper cuts are required at the toe of a bank area or on the bank itself. In these situations, the deeper cut can undermine the toe of the bank and can potentially cause slope instability if not accounted for in the design. For the 90% RD, the bank adjacent to T-117 and the Container Properties (RAA 27) area were identified for location-specific bank slope stability evaluation, as described in this section.

### 3.2.2 Terminal 117

The Pre-Final (90%) RD includes subtidal bank excavation adjacent to T-117 in RAA 14/15/16. Dredge depths of approximately 20 feet will be required between the toe and top of the slope using a temporary 2H:1V side slope.

Following excavation, an engineered cap will be constructed at the base of the slope, and the subtidal dredge cut slope will be backfilled to reestablish a new slope of 3H:1V. Figure G3-1 depicts the cross section and critical slip surface for the post-dredge (short-term) and post-backfill (long-term) condition for a representative cross section at station 217+40.

Stability analyses were run for the short-term condition (during bank cut) and long-term post-construction condition (including capping and backfill). Because the excavation is entirely subtidal, the rapid drawdown case was not evaluated.

Table G3-3 summarizes the resulting factors of safety for the bank stability evaluation at T-117. Both the short-term and long-term cases have acceptable factors of safety.

**Table G3-3**  
**Slope Stability Results – T-117**

Case	Side Slope (H:V)	Target Factor of Safety	Modeled Factor of Safety
Short-term	2H:1V	1.3	2.03
Long-term	3H:1V	1.5	1.93

Note:

H:V: horizontal to vertical

T-117: Terminal 117

### 3.2.3 Container Properties (RAA 27)

The Pre-Final (90%) RD includes bank excavation along the slopes at Container Properties (RAA 27). The existing bank transitions from the upland to an intertidal mud flat, and dredging and excavation will occur on the mud flat and banks, respectively. Dredge cut depths range from 2.5 to 3.5 feet at

the toe of bank, and the same minimum thickness cut will be performed on the bank itself at a slope no steeper than 2H:1V. Additional excavation thickness will be added on the bank and at the toe as necessary so that the final reconstructed bank does not raise the bathymetry above pre-construction conditions.

Following excavation, the bank will be reconstructed with layers of sand backfill beneath armor rock, as described elsewhere in the Pre-Final (90%) RD BODR. Figure G3-2 depicts the cross section and critical slip surface for the post-construction (long-term) condition at Container Properties.

To evaluate the stability of bank cuts, a limit equilibrium model was developed for the most critical stability case—that is, the cross section corresponding to the deepest dredge cut at the toe of bank. Stability analyses were run for the existing condition to check model calibration and assumed input parameters, and for the short-term condition (during bank cut), the long-term post-construction condition (including backfill sand and armor rock), and the rapid drawdown case, which assumes water levels beneath the armor rock near the face of the slope would correspond to MHHW.

Table G3-4 summarizes the resulting factors of safety for the bank stability evaluation at Container Properties.

**Table G3-4**  
**Slope Stability Results – Container Properties (RAA 27)**

Case	Side Slope (H:V)	Target Factor of Safety	Modeled Factor of Safety
Existing condition	2H:1V	N/A	1.22
Short-term	2H:1V	1.3	1.33
Long-term	2H:1V	1.5	1.49
Rapid drawdown	2H:1V	1.3	1.29

Notes:

H:V: horizontal to vertical

N/A: not applicable

RAA: remedial action area

As demonstrated in Table G3-4, the short-term, long-term, and rapid drawdown stability cases have acceptable factors of safety, indicating that the temporary slope cut of 2H:1V is appropriate and that the long-term armored slope will be stable after construction.

### 3.3 Cap Geotechnical Design Evaluation

The Pre-Final (90%) RD includes capping as a remedy technology for the dredge and cap area adjacent to T-117 (RAA 14/15/16) and for the reconstructed shoreline slope at Container Properties (RAA 27). Capping may be determined to be needed at other locations following review and

integration of the Phase III PDI data into the design during the Pre-Final (90%) RD. Thus, geotechnical capping evaluations prepared for the Intermediate (60%) RD were updated to support this Pre-Final (90%) RD.

This section describes cap bearing capacity and subgrade settlement evaluations completed for the Pre-Final (90%) RD of the upper reach sediment remedy and also describes the cap static stability evaluation. Seismic cap performance evaluations are discussed in Section 5.

### 3.3.1 *Bearing Capacity*

Bearing capacity caps were evaluated using methods described in *Guidance for In-Situ Subaqueous Capping of Contaminated Sediments* (Palermo et al. 1998). When cap material is placed on the surface of soft sediments, there is the potential for a bearing capacity failure directly through the in situ sediment. The initial cap lift thickness must be thin enough to maintain an acceptable factor of safety under the new loading caused by the weight of the cap.

In typical foundation design problems, a factor of safety of 3.0 is used for calculations wherein there is the potential for structural damage or impacts on human safety. This is the suggested factor of safety presented in the ARCS guidance. However, experience on other capping projects has shown that a factor of safety of 3.0 can be overly conservative when considering cap construction lift thickness. Because life safety and structural foundation stability are not design considerations for caps, and because slope stability evaluations use similar factors of safety, a factor of safety of 1.5 was considered appropriate for use in this analysis for evaluating the cap bearing capacity. Subaquatic cap placement has been successfully demonstrated at other sediment cleanup sites when designed using a bearing capacity factor of safety of 1.5, including the Whatcom Waterway sediment cleanup project (Anchor QEA 2015) and the San Jacinto River Superfund Site Time Critical Removal Action (Anchor QEA 2011).

This analysis evaluates the steady-state, short-term stability of the cap and soft sediments during construction. Once the cap has been placed, consolidation of fine-grained in situ sediments will occur, increasing the shear strength of the sediment. Thus, the long-term stability of the cap against bearing capacity failure will be greater than the short-term stability.

The in situ sediments must have sufficient internal strength to prevent local shear failure. To evaluate this condition, the ultimate bearing capacity was calculated with the Terzaghi equations for local failure (Palermo et al. 1998) using the undrained shear strengths described in Section 2.3:

**Equation G3-1**

$$q_{ult} = \left(\frac{2}{3}\right) s_u * N_c$$

where:

- $q_{ult}$  = ultimate bearing capacity of sediment (pounds per square foot [psf])
- $s_u$  = undrained shear strength of in situ sediments (psf)
- $N_c$  = bearing capacity factor (dimensionless) = 5.14 for continuous strip footing (Terzaghi and Peck 1967)

This equation applies to a cap placed on the surface of an entirely cohesive soil with an angle of internal friction,  $\phi'$ , equal to zero. For the caps placed in RAA 14/15/16, at least 4 feet of dredging would be performed before cap placement. Therefore, the shear strength at the 4-foot depth interval is considered appropriate for evaluating cap bearing capacity. Based on the shear strength assumptions presented in Table G2-2, the undrained shear strength of recent sediments below the 4-foot depth interval is 162 psf.

The ultimate bearing capacity was calculated as follows:

$$q_{ult} = \left(\frac{2}{3}\right) 162 * 5.14 = 555 \text{ psf}$$

A factor of safety of 1.5 was used to compute the allowable bearing capacity:

**Equation G3-2**

$$q_{all} = \left(\frac{q_{ult}}{FOS}\right)$$

where:

- $q_{all}$  = Allowable bearing capacity (psf)
- FOS = Factor of Safety = 1.5

$$q_{all} = \left(\frac{555}{1.5}\right) = 370 \text{ psf}$$

The initial cap lift thickness that could be supported by the lowest strength in situ sediments at an appropriate factor of safety was calculated using the allowable bearing capacity and the following equation:

**Equation G3-3**

$$h = \left( \frac{q_{all}}{\gamma'} \right)$$

where:

h	=	lift thickness
$\gamma'$	=	buoyant unit weight of cap material (pcf)
$\gamma'$	=	$\gamma - \gamma_w$
$\gamma$	=	total unit weight of cap material (pcf)
$\gamma_w$	=	unit weight of water (64 pcf)
$\gamma'$	=	110 pcf – 64 pcf = 46 pcf

$$h = \frac{370 \text{ psf}}{46 \text{ pcf}} = 8 \text{ feet}$$

This analysis, which uses the post-dredge in situ shear strength selected for modeling, indicates that the 4-foot-thick cap at RAA 14/15/16 can be placed while maintaining an appropriate factor of safety for sediment bearing capacity during construction, assuming a dredge depth of 4 feet prior to capping. In this configuration, the post-cap surface would not project above the pre-construction ground surface.

### 3.3.2 Subgrade Consolidation Settlement

Subgrade consolidation beneath the load imposed by a cap was assessed for two different scenarios. In both scenarios, the constructed cap would be placed after dredging, and the post-cap grade would be the same as the pre-dredge mudline elevation. The new loads imposed on the subgrade would be caused by the greater unit weight of cap material than the in situ unit weight of the sediments that will have been dredged. Two scenarios were evaluated for post-cap subgrade consolidation for RAA 14/15/16 reflecting different thicknesses of soft sediment beneath the cap, assuming the sediments and cap are entirely submerged.

Both scenarios assume 4 feet of dredging and placement of a 4-foot-thick cap. In Scenario A, 3 feet of soft sediment are assumed to remain beneath the cap. In scenario B, 11 feet of soft sediment are assumed remain beneath the cap. These assumptions allow for bracketing the results to understand the importance of the post-dredge soft sediment thickness that remains. Table G3-5 summarizes the scenarios evaluated for subgrade consolidation.

**Table G3-5  
Subgrade Consolidation Modeling Scenarios**

Scenario	Pre-Dredge Sediment Thickness (feet)	Dredge Depth (feet)	Post-Dredge Sediment Thickness (feet)	Cap Thickness (feet)	Net Stress Increase (psf)
A	7	4	3	4	40
B	15	4	11	4	40

Note:  
psf: pounds per square foot

Subgrade consolidation was calculated according to the following relationship:

**Equation G3-4**

$$\Delta H = H \times CR \times \log\left(\frac{\sigma'_{vo} + \Delta\sigma'_v}{\sigma'_{vo}}\right)$$

where:

- $\Delta H$  = consolidation settlement
- $H$  = consolidating layer thickness
- $CR$  = compression ratio of subgrade sediment (Table G2-2)
- $\sigma'_{vo}$  = in situ vertical effective stress
- $\Delta\sigma'_v$  = net stress increase (Table G3-2)

Table G3-6 summarizes the results of the subgrade consolidation evaluation.

**Table G3-6  
Subgrade Consolidation Summary**

Scenario	Estimated Consolidation Settlement (inches)
A	2
B	3

As shown in Table G3-6, the subgrade in RAA 14/15/16 is predicted to settle approximately 2 to 3 inches after cap placement. The magnitude of settlement is not sensitive to the assumed thickness of soft sediment that could remain beneath the cap.

The time rate over which consolidation occurs is a function of the distance porewater must travel (drainage path length) and the coefficient of consolidation of the subgrade. Time rate of consolidation was evaluated according to the following equation:

**Equation G3-5**

$$T = \frac{c_v t}{H_{DR}^2}$$

where:

$T$	=	time factor = 0.8 for 90% consolidation (Lambe and Whitman 1969)
$c_v$	=	coefficient of consolidation (Section 2.3)
$t$	=	time to achieve 90% consolidation
$H_{DR}$	=	drainage path length (Section 2.3)

Based on Equation G3-5, it is estimated that subgrade consolidation would be 90% complete approximately 120 days after cap construction.

Subgrade consolidation settlement can confound the interpretation of bathymetric survey results if bathymetry surveys are used to confirm the thickness of caps. When subgrade consolidation settlement occurs, bathymetry comparisons (i.e., isopach mapping) can be incorrectly interpreted as indicating "thinning" of cap material. Therefore, supplemental cap confirmation approaches such as thickness probing would also be included in Long-Term Maintenance and Monitoring Plan (LTMMP) planning to address potential issues associated with subgrade consolidation if caps are to be constructed.

### 3.3.3 *Static Slope Stability of Caps*

The Pre-Final (90%) RD includes a cap within the armored revetment to be constructed along the Container Properties shoreline (RAA 27). The cap at Container Properties would be placed following excavation, resulting in a cap surface that generally matches the pre-construction grade or flatter in the capping area. This section describes the static slope stability evaluation at Container Properties (RAA 27) where an intertidal cap would be constructed on the bank.

Cap slope stability was evaluated using limit equilibrium methods. A geologic profile was developed for Container Properties using the soil and sediment geotechnical engineering parameters presented in Table G2-2. The modeling software was set to search for the critical slip surface for any location within the slope at Container Properties.



Figure G3-2 presents the geologic profile for the Container Properties shoreline and depicts the critical slip surface and factor of safety. The factor of safety for the cap is 1.49, which is considered acceptable.

### 3.4 Backfill Design

This section describes the gradation and stability design of backfill materials.

#### 3.4.1 Backfill Gradation

The selection of backfill considers several engineering considerations, including the following:

- Commercially available, natural aggregate materials
- Appropriate proportion of gravel within the aggregate mixture to provide stability to backfill placed on slopes, as evaluated in Section 3.4.2
- Limiting the percentage fines (material that passes the U.S. No. 200 Sieve) to protect water quality by minimizing turbidity during placement

Table G3-7 presents a backfill gradation that achieves these objectives and was assumed for geotechnical analysis. The remedial contractor may identify material that is very similar to this gradation and that may be acceptable for use as backfill. The engineer should review any proposed deviations from this specification and may approve an alternate gradation in consultation with EPA.

**Table G3-7**  
**Backfill Gradation Specifications**

Sieve Size	Percent Passing
4-inch	100
2-inch	70 to 100
U.S. No. 4	50 to 80
U.S. No. 40	0 to 30
U.S. No. 200	0 to 5

In addition to engineering considerations, there may be additional habitat considerations that would be evaluated separately in consultation with EPA. Further, backfill material must meet or be lower than chemical concentration limits that will be defined in the project specifications based on cleanup levels for human health and benthic protection.

#### 3.4.2 Backfill Stability

Backfill will be placed in habitat areas (elevations greater than -10 feet MLLW) in accordance with the ROD (EPA 2014). In some dredge areas, backfill may need to be sloped below elevation -10 feet

MLLW until it meets the post-dredge surface at depth. This section presents the evaluation of stable backfill slope angles to support the backfill grading design.

Backfill slope stability was evaluated using infinite slope stability theory, in accordance with Duncan and Wright (2005). For this evaluation, the factor of safety for a 3H:1V backfill slope was computed using the following equation:

**Equation G3-6**

$$FOS = \frac{\tan(\phi')}{\tan(i)}$$

where:

$FOS$  = Factor of Safety  
 $\phi'$  = backfill friction angle (Table G2-2)  
 $i$  = slope angle

The factor of safety for backfill placed at a 3H:1V slope is 1.9, which is greater than the target long-term slope stability factor of safety. Thus, a 3H:1V slope angle should be used for the design of backfill slopes.

Where steeper slopes may be needed, armor rock could be used to protect the backfill surface. Shoreline armor has a higher friction angle than sand and gravel backfill and is typically assumed to range from 38 to 42 degrees for angular rock (USDA 1989). Assuming an armor rock friction angle of 38 degrees, slopes of 2H:1V have a factor of safety of 1.6, which is greater than the minimum long-term factor of safety of 1.5. Thus, backfill can be placed on 2H:1V slopes if angular armor rock is used.

## 4 Geotechnical Engineering Recommendations to Support Structural Engineering Evaluations

This section presents geotechnical engineering recommendations to support structural evaluations of vertical structures such as bulkheads and bridge piers, and to design replacement piles that may be needed as part of remedy construction in the upper reach. Necessary structural engineering evaluations were developed for the Pre-Final (90%) RD based in part on the recommendations provided in this section.

### 4.1 Vertical Structure Evaluation Geotechnical Recommendations

This section provides recommendations for the structural engineer to use for the evaluation of existing vertical structures adjacent to RAL exceedance areas.

#### 4.1.1 Lateral Earth Pressures for Shoreline Structures

The following lateral earth pressure recommendations are provided for structural evaluation of cantilevered shoreline bulkhead walls. This information can be used to assess the need for offsets or other measures if dredging needs to be performed in front of bulkheads.

Lateral earth pressures acting on the bulkhead will depend primarily on the following:

- Fill material placed behind the wall, and the degree of compaction immediately adjacent to the wall
- Flexibility of the wall, and the degree of movement that the wall undergoes
- The presence of any surcharges or concentrated loads adjacent to the bulkhead
- Wall drainage
- Seismic loading

If the bulkhead is permitted to yield such that the top can move laterally at least 0.1% of the bulkhead's retained height when loaded, active earth pressures will develop. If this level of deflection is intolerable, the wall should be evaluated using at-rest soil pressures.

To design for lateral earth pressures, the parameters provided in Table G4-1 should be used. Earth pressures may be computed assuming a triangular pressure distribution applied from the top of the bulkhead to the base of the sheeting, as shown in Figure G4-1. Passive pressures will also be applied in a triangular distribution, from the mudline downward.

**Table G4-1  
Bulkhead Lateral Earth Pressure Parameters**

Parameter	Design Value
GWT behind bulkhead	6 feet MLLW
Upland soil effective unit weight above GWT	135 pcf
Upland soil effective unit weight below GWT	71 pcf
Upland soil effective friction angle ( $\phi'$ )	33 degrees
Upland soil cohesion c	0 psf
Waterway sediment effective unit weight above waterline	100 pcf
Waterway sediment effective unit weight below waterline	36 pcf
Waterway sediment effective friction angle ( $\phi'$ )	27 degrees
Waterway sediment cohesion (c)	0 psf
$K_A$ – active pressure coefficient for upland soils – flexible walls	0.29
$K_O$ – at rest pressure coefficient for upland soils – rigid walls	0.46
$K_P$ – passive pressure coefficient for waterway sediments <sup>1</sup>	2.66

Notes:

1. Passive pressures are presented as ultimate values and do not include a factor of safety.

GWT: groundwater table elevation

MLLW: mean lower low weight

pcf: pounds per cubic foot

psf: pounds per square foot

As noted in Table G4-1, using the passive pressure coefficient provided would result in calculating ultimate passive soil resistance, which would be an appropriate assumption for calculating the potential reduction in passive resistance at the toe of the wall when dredging occurs. Figure G4-1 depicts the pressure distribution for active and passive earth pressure conditions and provides recommendations for temporary tieback no-load zone and tentative tieback adhesion values.

#### 4.1.2 *Effect of Prohibiting Surcharge Loads Above Bulkheads During Adjacent Dredging*

Bulkheads retain soil loads and surcharges in the form of active or at rest lateral earth pressures. These earth pressures are resisted at the toe of the bulkhead by passive earth pressures provided by the sediments in front of the bulkhead. The following discussion evaluates how much of the passive earth pressure is needed to resist surcharge loads alone and the effect to prohibiting surcharge loads

during dredging. This assessment was developed using generalized soil and sediment conditions and thus is applicable to structures throughout the upper reach.

It is assumed that shoreline bulkheads were designed and constructed to support temporary surcharge loads at the top of the bulkheads. Typically, a temporary surcharge of 250 psf (or higher) can be accommodated by marine shoreline structures in good condition. Assuming a bulkhead backfill unit weight of 135 pcf, 250 psf is effectively equivalent to a soil surcharge height of approximately 2 feet.

One way to protect structures during adjacent dredging is to prohibit surcharge loading during dredging. This effectively allows for the "design surcharge capacity" of the wall to be used to offset the temporary loss of passive pressure in front of the wall due to dredging.

To evaluate this factor, the bulkhead adjacent to CenterPoint Properties was selected as a representative example. The bulkhead at this location currently has a retained soil height of approximately 15 feet. The active lateral earth pressure behind the wall (no surcharge) is calculated as follows:

**Equation G4-1**

$$P_A = 1/2 K_A \gamma h^2$$

where:

- $P_A$  = Active earth pressure resultant force (pounds per foot [lb/ft])
- $K_A$  = Active earth pressure coefficient for retained soil (Table G4-1)
- $\gamma$  = unit weight of retained soil (Table G4-1)
- $h$  = retained height of soil (feet)

For the CenterPoint Properties bulkhead, the resultant active earth pressure is calculated to be 4,400 pounds per foot (lb/ft).

Adding 1.85 feet of retained height for the surcharge loading condition (equivalent to a retained soil height of 16.85 feet), the active lateral earth pressure is calculated to be 5,560 lb/ft, which means that prohibiting surcharge during dredging could offset the loss of 1,160 lb/ft of passive pressure.

Passive earth pressure is calculated as follows:

**Equation G4-2**

$$P_p = \frac{1}{2} K_p \gamma d^2$$

where:

$P_p$	=	passive earth pressure resultant force (lb/ft)
$K_p$	=	passive earth pressure coefficient for sediments (Table G4-1)
$\gamma$	=	unit weight of sediments (Table G4-1)
$d$	=	depth below mudline (feet)

For the passive pressure coefficients for sediments presented in Table G4-1, a depth of approximately 5 feet below mudline is required to achieve a passive pressure of 1,160 lb/ft when sediments are submerged (buoyant unit weight providing passive pressure) or approximately 3 feet below mudline when sediments are not submerged (total unit weight providing passive pressure).

Based on this evaluation, for shoreline bulkheads in good condition that were designed to support an upland surcharge of at least 250 psf, prohibiting surcharges during dredging would allow for 3 to 5 feet of dredging to occur while maintaining passive pressure support comparable to the surcharge loading condition with no dredging.

Note that this assessment considers the soil loads only and does not account for the condition of the bulkhead wall nor the stresses in the wall structure that might be imposed by removing passive support during dredging.

#### 4.1.3 *Effect of Dredging on Passive Pressure*

As previously discussed, dredging adjacent to structures reduces lateral toe support (i.e., passive pressure), which can increase the loads on the structure. This section describes the evaluations performed to determine appropriate reductions in passive pressure considering the following:

- Dredge cut slope angle
- Dredge cut depth
- Horizontal offset of dredge cut from the structure

The analyses presented in this section were developed specific to the Recent Sediments material that would be removed by dredging and is applicable to any vertical structure in the upper reach (e.g., bulkheads, bridge piers). To conduct this analysis, the total available passive pressure (no

dredging) was compared to the weight of the passive wedge that would remain after dredging. The reduction factor was calculated as follows:

**Equation G4-3**

$$\text{Reduction Factor} = \frac{W_w}{P_R}$$

where:

$W_w$  = Buoyant weight of passive soil wedge between structure and toe of dredge cut (lb/ft)

$P_R$  = Passive earth pressure force for the no dredging scenario calculated at the evaluated depth of dredging (lb/ft)

Offsets of 0, 2, and 4 feet from the structure were considered. A range of dredge depths from 5 to 15 feet deep was evaluated. Dredge cut side slopes of 2H:1V, 1.5H:1V, and 1H:1V were assessed.

Key conclusions from this evaluation, in the form of passive earth pressure reduction factors, are presented in Table G4-2.

**Table G4-2**  
**Passive Earth Pressure Reduction Factors**

Offset Distance (feet)	Reduction Factor		
	2H:1V	1.5H:1V	1H:1V
0	0.75	0.56	0.38
2	0.85	0.66	0.48
4	0.95	0.76	0.58

Note:

H:V: horizontal to vertical (ratio)

As shown in Table G4-2, when the dredge prism is not offset, the passive earth pressure could be significantly reduced, particularly if the dredge cut is oversteepened beyond the recommended 2H:1V temporary cut slope. Reduced passive pressure increases the risk of damaging structures.

The reduction factors presented in Table G4-2, in conjunction with the earth pressure recommendations in Table G4-1, can be used by the structural engineer to determine recommended structural offsets for dredging.

## 4.2 Pile Design Recommendations

Miscellaneous single piles or dolphin pile groups may need to be removed to accomplish construction. This section presents geotechnical engineering pile design recommendations for the structural engineer’s use in designing replacement piles.

Based on discussion with the project structural engineer, replacement piles are likely to be hollow steel pipe piles, which lend themselves to vibratory installation and are capable of supporting the range of loads anticipated for this project. Timber piles are not considered for new installations for the upper reach because timber piles require chemical treatment to prevent decay.

Replacement piles are expected to be primarily laterally loaded. Pile design to resist lateral loads can be accomplished using L-PILE or similar software to assess pile deflection under loading and required depth to fixity below the mudline. Table G4-3 presents recommended L-PILE parameters to model the recent sediments and alluvium. .

**Table G4-3**  
**L-PILE Modeling Parameters**

Layer	Effective Unit Weight $\gamma'$ (pcf)	Friction Angle $\phi$ (°)	Undrained Shear Strength $c_u$ (kip/ft <sup>2</sup> )	P-Y Curve Model	Spring Constant; K ( $E_s=Kx$ ) k (pci)	Strain Factor; @50% max E $\epsilon_{50}$
Recent sediment	36	27	0.08	Soft clay (Matlock)	N/A	0.020
Alluvium	61	32	N/A	Sand (Reese)	20	N/A

Notes:

ft<sup>2</sup>: square foot

kip: one thousand pounds

N/A: not applicable

pcf: pounds per cubic foot

pci: pounds per cubic inch



## 5 Seismic Design

The upper reach of the LDW is located within the seismically active Puget Lowland, a region characterized by bedrock faults and tectonic plate movement and that has a documented history of earthquake activity. Earthquakes occur when energy accumulated during fault or tectonic plate movement is suddenly released over a short time span. The location of energy release, known as the epicenter of an earthquake, can occur at different places in a fault system.

The ground shaking caused by an earthquake can cause loose soils to lose strength as porewater pressure increases. This phenomenon, known as liquefaction, can cause soil movement and ground settlement. Earthquakes can also shake structures and impose loads on structural elements and foundations. Seismic risks are assessed in geotechnical engineering using a variety of tools.

This section describes the seismic design of the sediment remedy for the upper reach with a focus on the anticipated performance of remedial elements (primarily sediment caps) under earthquake loading. This section also provides recommended seismic design parameters for use by the structural engineer, as appropriate.

### 5.1 Seismic Site Class

Seismic behavior is generally assessed by evaluating the relative density of near-surface soils (the upper 100 feet below ground surface). For seismic design, relative density is often characterized by the average shear wave velocity of the soil column, which governs how earthquake energy is amplified or dampened by the near-surface soils. A Washington State-wide study by Cakir and Walsh (undated) summarized measurements of shear wave velocity at different sites across the state, including three locations in the Duwamish River basin near the upper reach. This study identified a typical seismic site class between Class D and Class E based on average shear wave velocities between 131 and 183 meters per second for the Duwamish River area in the vicinity of the upper reach.

### 5.2 Strong Motion Design Input Parameters

For seismic evaluations, earthquake peak ground acceleration (presented as a percentage of the force of gravity) and earthquake magnitude are key input parameters.

The U.S. Geological Survey (USGS) provides internet-based tools that, using mapped locations and seismic site classes, output peak ground accelerations, and earthquake magnitudes for different recurrence interval earthquakes.

For the upper reach sediment remedy, two different earthquake types were considered:

- A 100-year recurrence interval earthquake, consistent with typical protectiveness evaluations for other remedy elements such as cap contaminant modeling
- A 475-year recurrence interval earthquake, which has traditionally been the size of event considered on other regional Superfund projects based on a 10% probability of exceedance in a 50-year time frame

Table G5-1 provides the key USGS output parameters used for geotechnical seismic assessment for both events.

**Table G5-1  
Earthquake Parameters used in Geotechnical Engineering Evaluations**

Event Recurrence Interval	PGA (% gravity)	Mean Magnitude
100 years	0.19	6.7
475 years	0.41	7.0

Notes:

Data developed for latitude 47.522, longitude -122.306.

Site Class D/E; Dynamic Conterminous United States model (2014 edition v4.2.0).

Model source: <https://earthquake.usgs.gov/hazards/interactive>.

PGA: peak ground acceleration

### 5.3 Liquefaction Evaluation

As described in Section 2, the site investigation included CPTs at 20 different locations in the upper reach. Digital records from these CPTs were processed by the analytical software Cliq (version 3.3.1.14), which facilitates liquefaction assessment and estimates of liquefaction-induced settlement using CPT measured parameters, earthquake peak ground accelerations, and earthquake magnitude.

For all locations investigated with a CPT, liquefaction was predicted during both the 100- and 475-year earthquakes. The estimated magnitude of liquefaction-induced settlement did not significantly vary between the two earthquakes, ranging from 3 to 14 (median 7) inches of settlement in the upper 30 feet below ground surface.

### 5.4 Seismic Performance of Capped Slopes

The seismic performance of capped slopes was evaluated using limit equilibrium methods, as described for the slope stability discussions in Section 3. A geologic cross section of the slope at Container Properties (RAA 27) was modeled, and seismic forces associated with both the 100- and 475-year earthquakes were added. For the 475-year earthquake, the resulting factor of safety was less than 1.0, indicating that some movement of the capped slope can be expected during a

significant earthquake. For the 100-year earthquake, the factor of safety was 1.15 at Container Properties. Figure G5-1 depicts the cross section evaluated for Container Properties (RAA 27), as well as the critical slip surface and factors of safety for the 100-year earthquake at this location.

In general, shoreline slopes are susceptible to movement during strong earthquake shaking. Slopes designed to resist movement could require significant structural reinforcement that is not compatible with the habitat and human uses of shorelines. In part, due to issues like this, the geotechnical engineering community is moving toward a performance-based assessment of slopes, when appropriate, for seismic design. In the case of shoreline slopes where life safety and structures are not at risk, this type of assessment does not attempt to design for preventing movement; rather, a performance-based approach evaluates how much movement could be expected during an earthquake and what mitigation measures, if any, would need to be implemented after the earthquake had occurred.

Slope displacement was estimated for both the 100- and 475-year earthquakes in accordance with the methods presented by the National Cooperative Highway Research Program (NCHRP 2008). Table G5-2 presents the estimated slope displacement for Container Properties under both earthquake scenarios. Because the cap in RAA 14/15/16 is not on a slope, slope displacement estimates are not applicable.

**Table G5-2**  
**Seismic Slope Displacement for Container Properties (RAA 27) Cap**

Earthquake Return Interval	Container Properties Cap Estimated Displacement
100 years	< 0.5 inch
475 years	8 to 16 inches

Note:  
RAA: remedial action area

## 5.5 Conclusions on Seismic Performance of Sediment Remedy

Based on the liquefaction assessment and slope displacement estimates, the sediment remedy is expected to have acceptable seismic performance. Anticipated settlement and displacement under the 100-year event is expected to be significantly less than any design cap thicknesses. During a larger earthquake, the cap and sediments beneath may move down the slope, but any cap damage from such movement is expected to be easily repaired.

Post-earthquake mitigation measures could include visual inspections and bathymetry surveys to evaluate cap condition. Cap repairs, if needed, could be readily implemented by adding more cap substrate to address any local thinning associated with post-earthquake deformation or settlement.

The LTMMP will consider these evaluations and set criteria for inspections following seismic events.

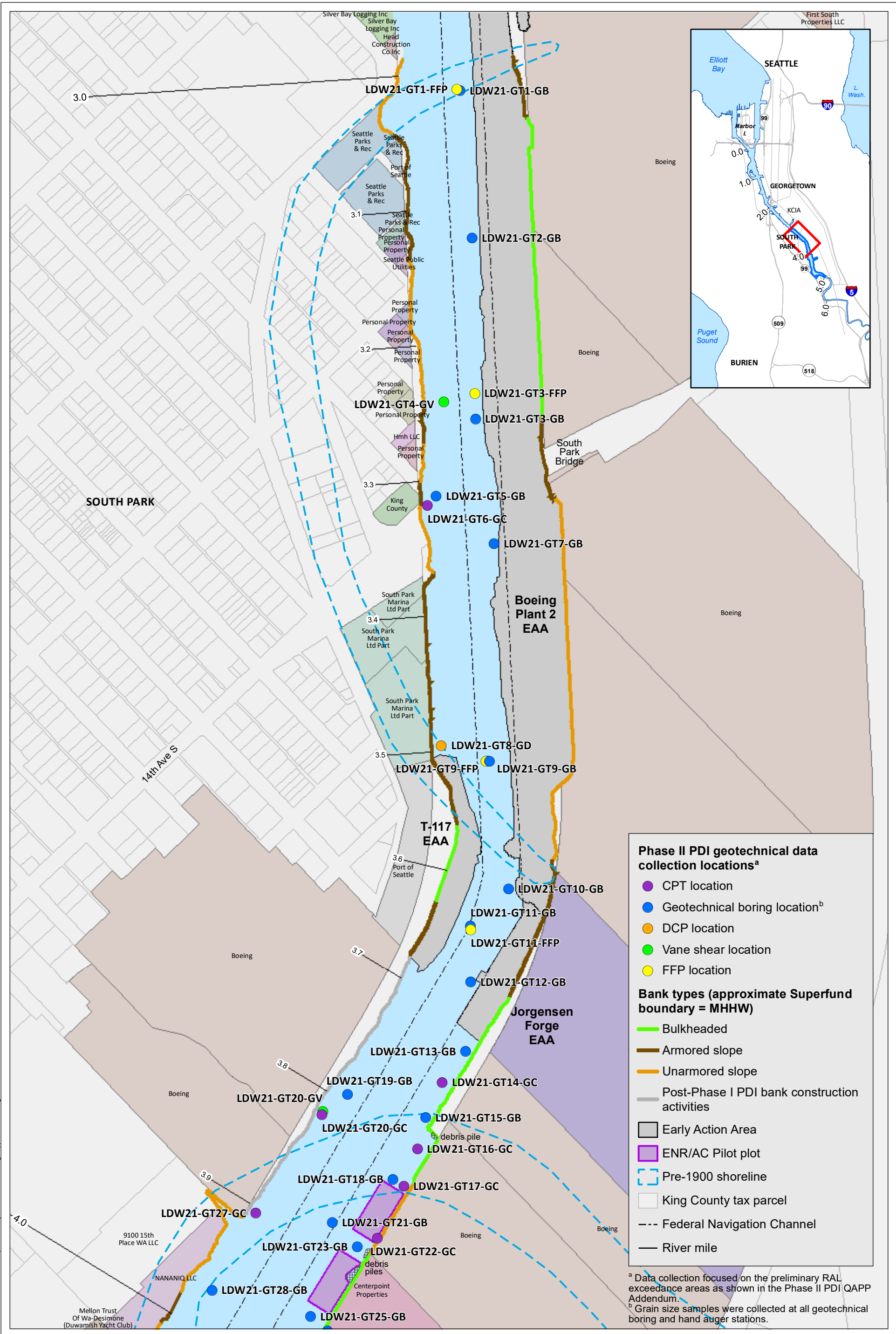
## 6 References

- AMEC, 2002. *Limited Geotechnical Engineering Report Delta Marine Industries Boat Lift Pier 1608 S. 96th Street Seattle Washington*. May 2002.
- AMEC, 2012. *Geotechnical Engineering Report Habitat Project Boeing Plant 2 Seattle/Tukwila Washington*. October 2012.
- Anchor QEA (Anchor QEA, LLC), 2011. *Final Removal Action Work Plan San Jacinto River Waste Pits Superfund Site*. Prepared for EPA Region 6. Revised February 2011.
- Anchor QEA, 2015. *Whatcom Waterway Final Engineering Design Report*, Appendix B. Prepared for the Port of Bellingham. March 16, 2015.
- Anchor QEA and Windward (Anchor QEA, LLC; Windward Environmental LLC), 2022. *Pre-Design Investigation Data Evaluation Report*. Final. Submitted to EPA July 15, 2022.
- Cakir, R., and T. Walsh (undated). *Shallow Seismic Site Characterizations of Near-Surface Geology at 20 Strong Motion Stations in Washington State*. Final Technical Report USCS/NEHRP Award Number G09AP00021. Washington Department of Natural Resources.
- Duncan, J.M., and S.G. Wright, 2005. *Soil Strength and Slope Stability*. First Edition. New Jersey: John Wiley and Sons.
- EPA (U.S. Environmental Protection Agency), 2014. *Record of Decision*. Lower Duwamish Waterway Superfund Site.
- GeoEngineers, 2014. *Geotechnical Engineering Services Terminal 117 Site Restoration for Port of Seattle*. May 2014.
- Lambe, T., and R. Whitman, 1969. *Soil Mechanics*. John Wiley and Sons.
- Landau and AMEC (Landau Associates; AMEC), 2014. *Final Remedial Investigation Report Boeing Isaacson-Thompson Site Tukwila Washington*. Prepared for The Boeing Company. April 21, 2014.
- NCHRP (National Cooperative Highway Research Program), 2008. *Seismic Analysis and Design of Retaining Walls, Buried Structures, Slopes and Embankments*. National Cooperative Highway Research Program Report 611. Transportation Research Board.

- Palermo, M., S. Maynard, J. Miller, and D. Reible, 1998. *Guidance for In-Situ Subaqueous Capping of Contaminated Sediments*. Great Lakes National Program Office, Chicago, Illinois. EPA 905-B96-004.
- Robertson, P.K., and K.L. Cabal, 2010. *Guide to Cone Penetration Testing for Geotechnical Engineering*. Gregg Drilling and Testing, Inc. July 2010.
- SPU (Seattle Public Utilities), 2012. *Draft Geotechnical Report Seattle Substation Evaluation Seattle, Washington Duwamish Substation*. Work Authorization NS12212 MG1. November 2012.
- SPU, 2014. Geotechnical Memorandum Dallas Avenue South Drainage Project Subsurface Infiltration Recommendations. June 2014.
- Terzaghi, K., and R. Peck, 1967. *Soil Mechanics in Engineering Practice*. Second edition. Wiley.
- USACE (U.S. Army Corps of Engineers), 2003. *Slope Stability*. Engineering Manual EM 1110-2-1902.
- USDA (U.S. Department of Agriculture), 1989. Loose Riprap Protection Minnesota Technical Note 3. United States Department of Agriculture Soil Conservation Service. July 1989.

## Figures

---



**Phase II PDI geotechnical data collection locations<sup>a</sup>**

- CPT location
- Geotechnical boring location<sup>b</sup>
- DCP location
- Vane shear location
- FFP location

**Bank types (approximate Superfund boundary = MHHW)**

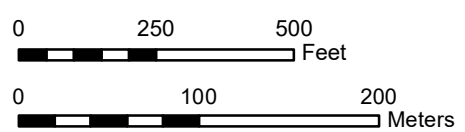
- Bulkheaded
- Armored slope
- Unarmored slope
- Post-Phase I PDI bank construction activities

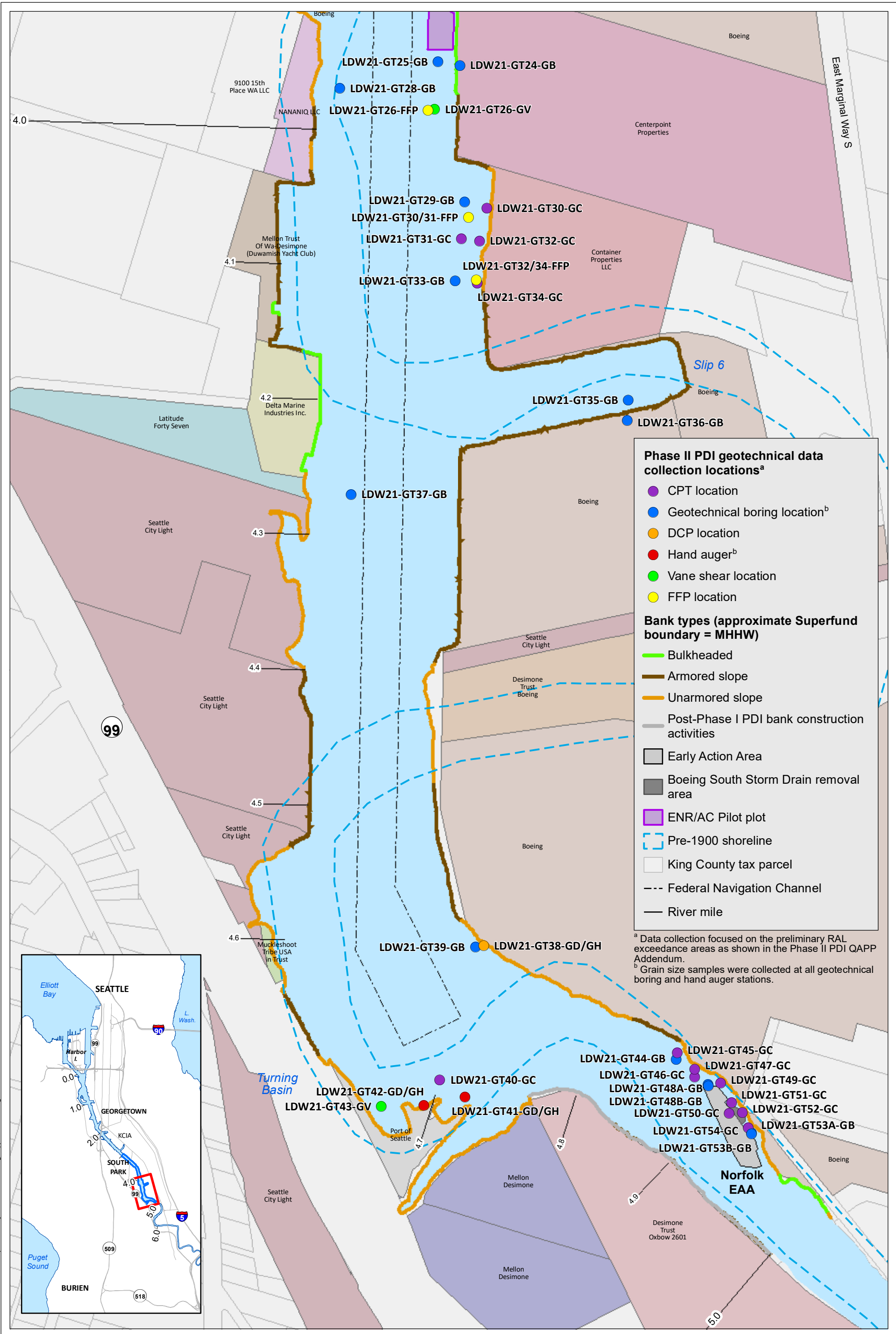
**Other features:**

- Early Action Area
- ENR/AC Pilot plot
- Pre-1900 shoreline
- King County tax parcel
- Federal Navigation Channel
- River mile

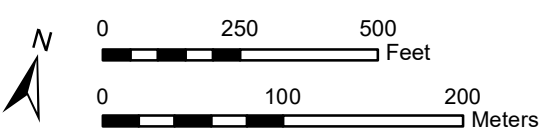
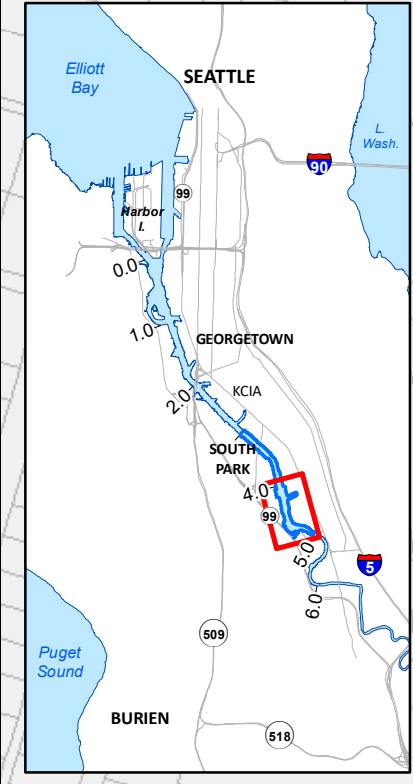
<sup>a</sup> Data collection focused on the preliminary RAL exceedance areas as shown in the Phase II PDI QAPP Addendum.  
<sup>b</sup> Grain size samples were collected at all geotechnical boring and hand auger stations.

Prepared by craigh.7/13/23: W:\Projects\Duwamish\_AOC4\GIS\Maps and Analyses\90\_Percent\_Design\Map\G\_Geotech\Locations\_RM3-4.mxd



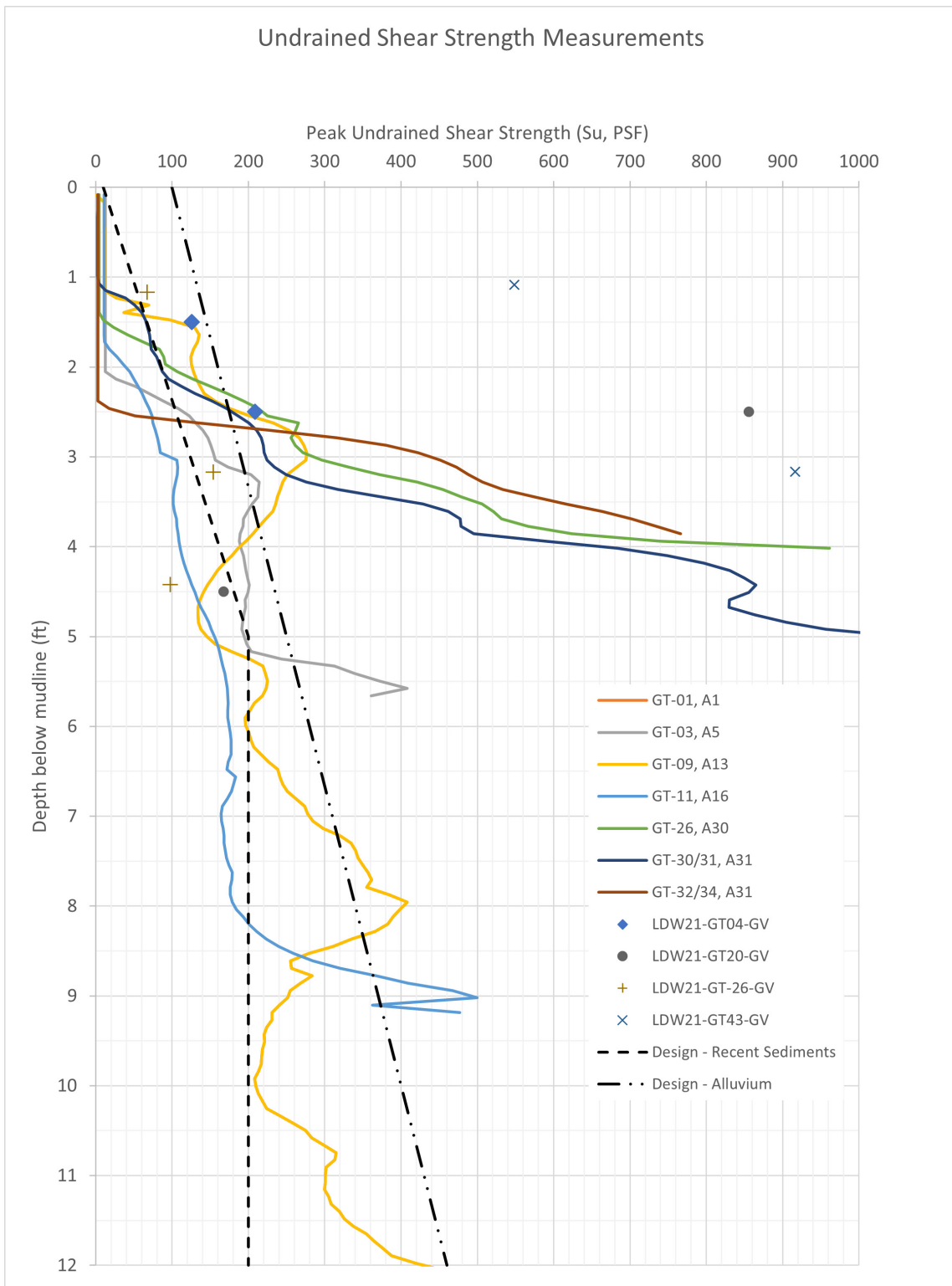


Prepared by craigh.7/13/23. W:\Projects\Duwamish\_AOC\GIS\Maps and Analyses\90\_Percent\_Design\Map\G\_Geotech\Fig\_G1-1b\_PDI\_Geotech\_locations\_RM4-5.mxd

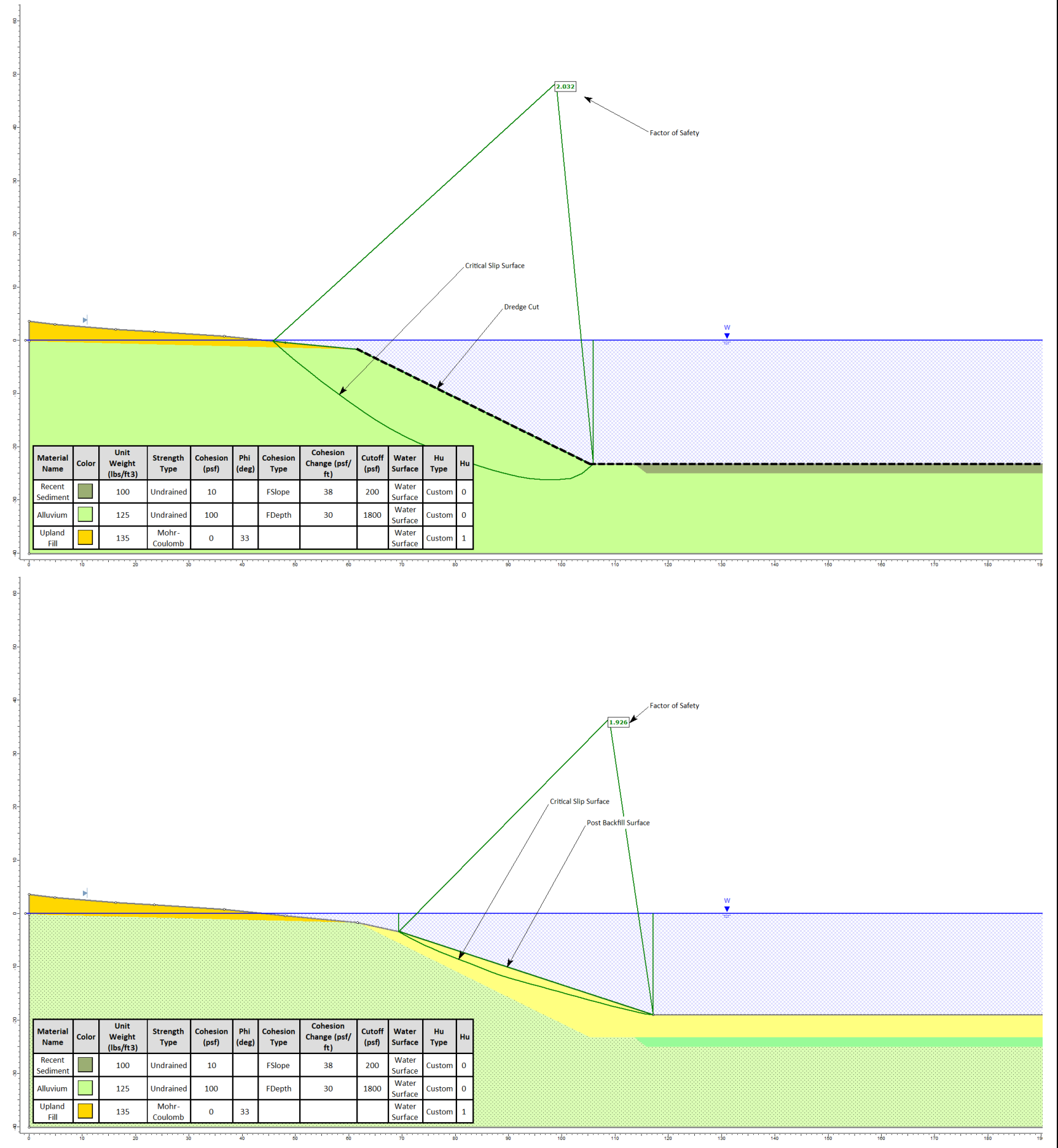




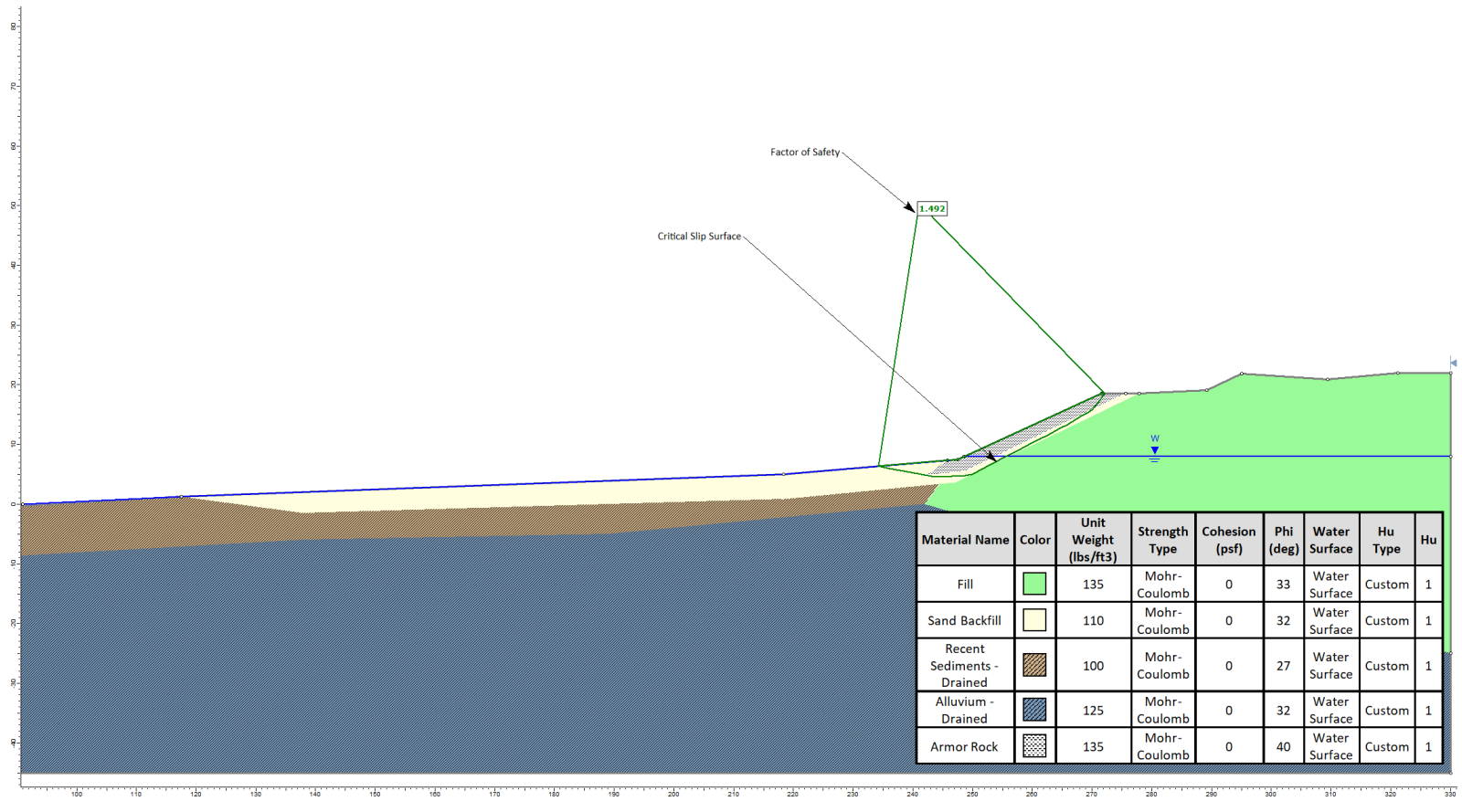
**Figure G2-1  
Undrained Shear Strength Test Results and Design Assumptions**



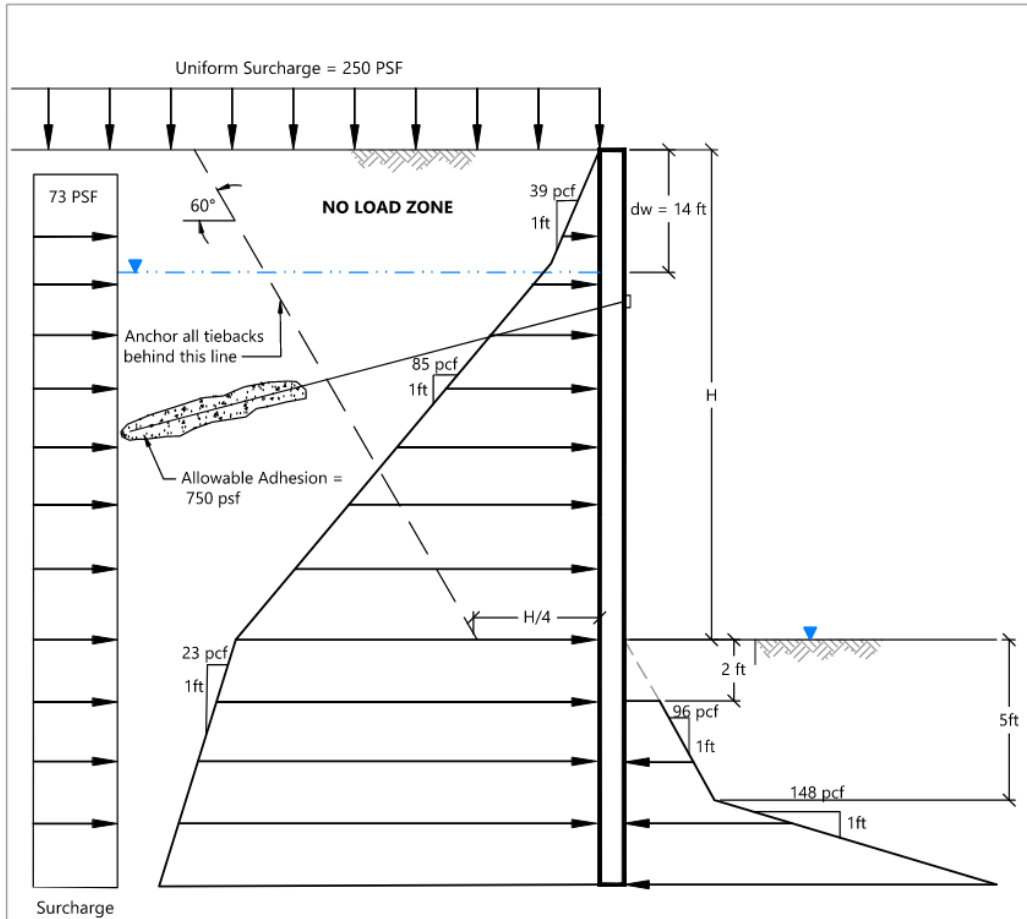
**Figure G3-1**  
**Slope Stability – Short Term and Long Term Offshore of T-117**



**Figure G3-2**  
**Container Properties Slope Stability Results – Long Term**



**Figure G4-1**  
**Lateral Earth Pressures**



**NOTES:**

1. Yielding walls are those walls that will deform at least 0.001 times the height of the wall.
2. Passive pressures are Ultimate values and do not include a factor of safety. We recommend applying a factor of safety of at least 1.5 when computing static passive pressures.
3. Ignore the contribution of the upper 2 feet of soil at the base of the wall when computing passive pressures.
4. Active and at-rest earth pressures are for cantilever walls or walls supported by a single row of tiebacks.
5. Anchor pull out resistance is based on non-pressure-grouted straight shaft anchors. These values should be considered tentative and for planning purposes only. Actual values will need to be determined on the basis of field testing prior to construction.
6. Passive Pressure acts over 2 pile diameters.

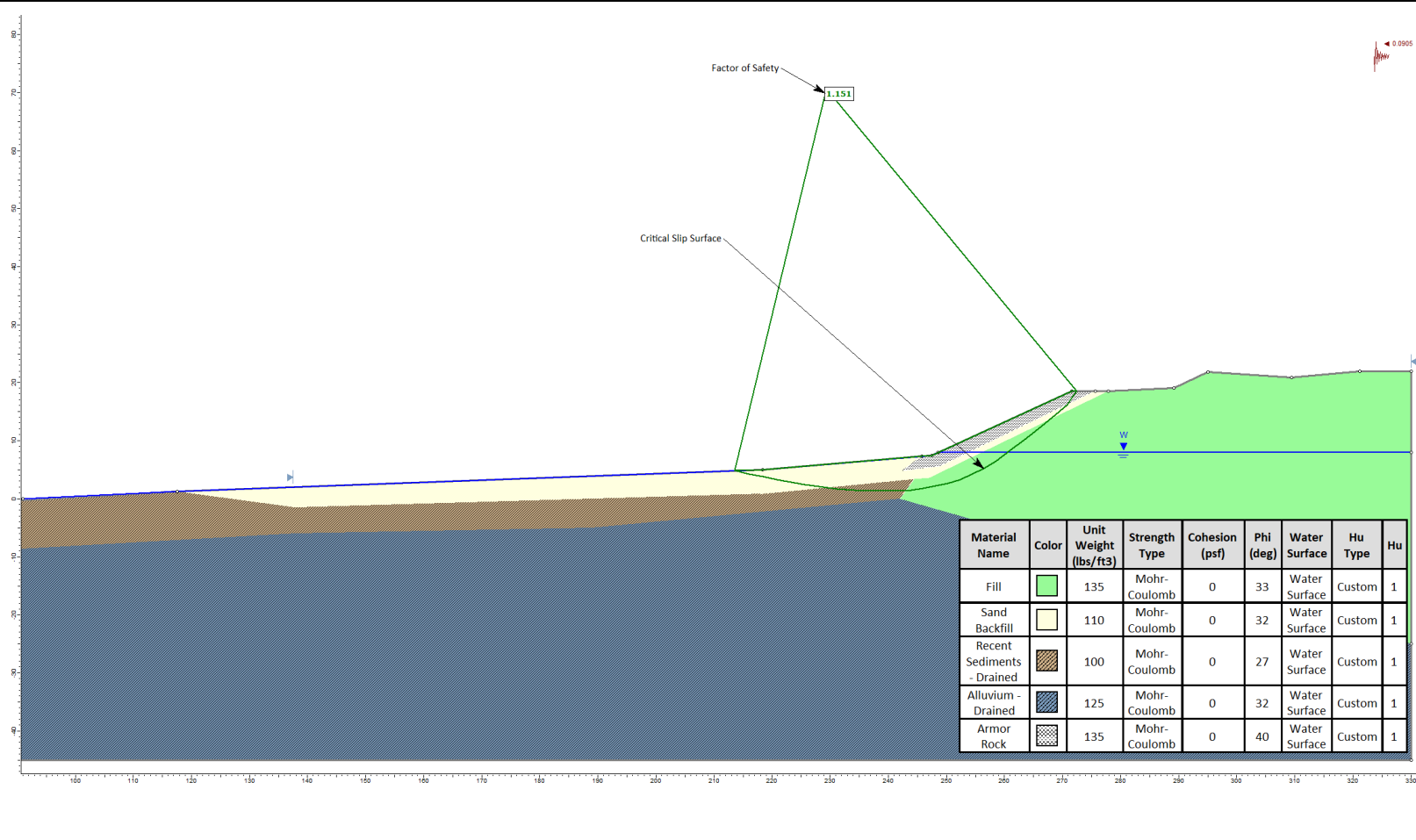
**Not to Scale**

Passive Earth Pressure Reduction Factors			
Offset Distance	Reduction Factor		
	2H:1V	1.5H:1V	1H:1V
0	0.75	0.56	0.38
2	0.85	0.66	0.48
4	0.95	0.76	0.58

Publish Date: 2023/01/23 10:03 AM | User: jfoster  
 Filepath: K:\Projects\0067-King County\LDW Upper Reach Engineering Services\0067-RP-032 Lateral Earth Pressures.dwg Figure X



**Figure G5-1**  
**Seismic Performance of Caps on Slopes – Container Properties 100-Year Event**



## Appendix G – Geotechnical Design Analysis

### Attachment G.1

### Subsurface Investigation Program and Field Logs

---

Boring Location: 47.511241606, -122.302597174  
 N:1277329.59455 E:189951.293072

Hand Auger GT41 Date 8/3/21 Sheet 1 of 2  
 Job LDW21 Job No. 180067-02.03  
 Logged By Garrett Timm, Andrew B Weather 85 degrees & sunny  
 Excavated By Anchor QEA  
 Excavation Method Hand Auger 3.5' O.D.  
 Sampling Method NA  
 Bottom of Hand Auger 2 ft.

Elevation: Datum:

SIZE (%)			PID or other	SAMPLE		SAMPLE RECOVERY	DESCRIPTION: Den., moist., color, minor, MAJOR CONSTITUENT, NON-SOIL SUBSTANCES: Odor, staining, sheen, scrag, slag, etc.
G	S	F		Type	Number		
Max.	Range	Att. Limits					
NA	90	10	NA	soil	1	0	(0 to 1.3 ft.) SM. very soft, moist, light brown and grey, medium grained SAND w/ pockets of silt, occasional organics.
NA	90	10	NA	soil	2	2	(1.3 to 2 ft.) SP. very loose, wet, dark grey, SAND, minor black staining, some silt. WT encountered @ 1.8ft.
							End of Boring @ 2 feet
							3
							4
							5
							6
							7
							8
							9
							10

Notes:



Boring Location:  
 47.511450999, -122.302013485  
 N: 1277475.27698 E: 190024.904784999

Hand Auger GT42 Date 8/3/21 Sheet 2 of 2  
 Job LDW21 Job No. 180067-02.03  
 Logged By Garrett Timm, Andrew B Weather 85 degrees & sunny  
 Excavated By Anchor QEA  
 Excavation Method Hand Auger 3.5' O.D.  
 Sampling Method NA  
 Bottom of Hand Auger 2.3 ft.

Elevation: Datum:

SIZE (%)			PID or other	SAMPLE		SAMPLE RECOVERY
G	S	F		Type	Number	
Max.	Range	Att. Limits				
NA	< 25	> 75	NA	soil	1	0
< 5	< 10	> 85	NA	soil	2	1
NA	> 95	< 5	NA	soil	3	2
						3
						4
						5
						6
						7
						8
						9
						10

DESCRIPTION: Den., moist., color, minor, MAJOR CONSTITUENT, NON-SOIL SUBSTANCES: Odor, staining, sheen, scrag, slag, etc.

(0 to 0.2 ft.) ML. organic SILT, roots

(0.2 to 1.5 ft.)ML. very soft, moist, grey, SILT. Contains occasional organics and brick pieces (fill) <0.5 inches

(1.5 to 2.3 ft.)SP. loose, moist, grey, SAND, medium grained.

End of Boring @ 2.3 feet

Notes:





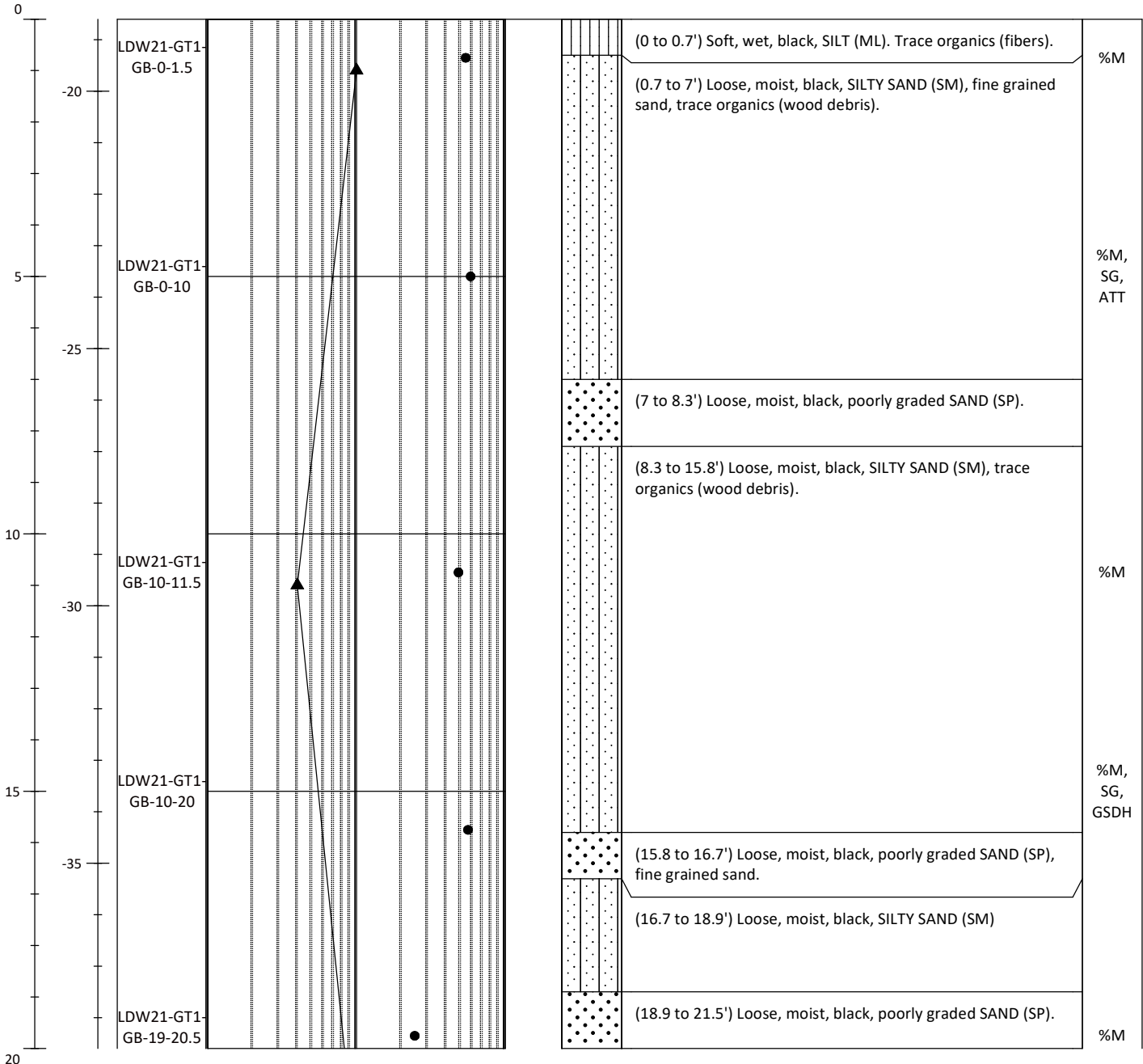
# [DRAFT] Soil Boring Log

## LDW21-GT1-GB

Sheet 1 of 2

Project #: <b>180067-02.03</b>	Project: <b>LDW Upper Reach Phase 2 Investigation</b>	Method: <b>Rotary Sonic</b>
Location: <b>Seattle, WA</b>	N/LAT: <b>197701.636</b> E/LONG: <b>1273353.682</b>	Total Depth (ft): <b>21.5</b>
Client: <b>Lower Duwamish Waterway Group</b>	Horiz. Datum: <b>Washington State Plane Coordinate North North American Datum of 1983, U.S. Feet</b>	Observed Depth to Mudline (ft): <b>27.2</b>
Collection Date: <b>07.09.21</b>		Mudline Elevation (ft): <b>-18.6</b>
Contractor: <b>Holocene Drilling, Inc</b>	Vert. Datum: <b>Mean Lower Low Water (MLLW)</b>	Hammer: <b>140-lb, 30-in drop, Auto</b>
Logged By: <b>Casey Janisch</b>	Sampler(s): <b>Split Spoon &amp; Shelby Tube Sampler</b>	Hammer Efficiency (%): <b>99</b>

Depth (ft)	Elevation (ft)	Sample ID	Uncorrected Standard Penetration Resistance (blows per foot) and Moisture Content (%)						Other	Lithology	Soil Description Samples and descriptions are in recovered depths. Classification scheme: USCS	Lab Test
			1	2	5	10	20	50				



- ▲ SPT N-Value
- Moisture Content (%)

**Notes:**  
 %M=Percent Moisture Content, SG=Specific Gravity, ATT=Atterberg Limits, GSD=Grainsize Distribution, GSDH=Grainsize Distribution+Hydrometer, 1-D: One-dimensional Consolidation, CU=Unconsolidated Comp. Mudline elevations determined from leadline measurements and Site tide gage levels

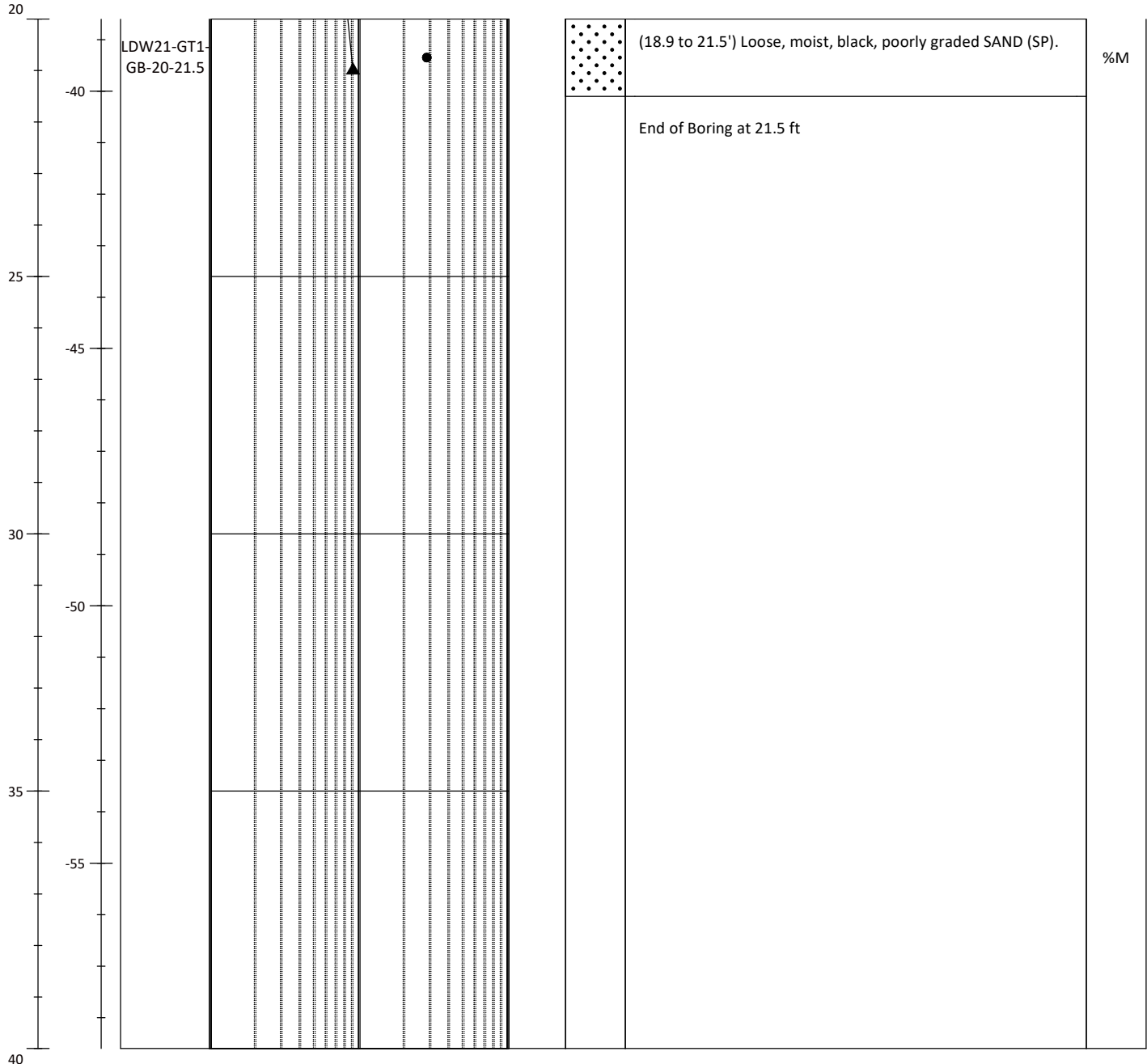
# [DRAFT] Soil Boring Log

## LDW21-GT1-GB

Sheet 2 of 2

Project #: <b>180067-02.03</b>	Project: <b>LDW Upper Reach Phase 2 Investigation</b>	Method: <b>Rotary Sonic</b>
Location: <b>Seattle, WA</b>	N/LAT: <b>197701.636</b> E/LONG: <b>1273353.682</b>	Total Depth (ft): <b>21.5</b>
Client: <b>Lower Duwamish Waterway Group</b>	Horiz. Datum: <b>Washington State Plane Coordinate North North American Datum of 1983, U.S. Feet</b>	Observed Depth to Mudline (ft): <b>27.2</b>
Collection Date: <b>07.09.21</b>		Mudline Elevation (ft): <b>-18.6</b>
Contractor: <b>Holocene Drilling, Inc</b>	Vert. Datum: <b>Mean Lower Low Water (MLLW)</b>	Hammer: <b>140-lb, 30-in drop, Auto</b>
Logged By: <b>Casey Janisch</b>	Sampler(s): <b>Split Spoon &amp; Shelby Tube Sampler</b>	Hammer Efficiency (%): <b>99</b>

Depth (ft)	Elevation (ft)	Sample ID	Uncorrected Standard Penetration Resistance (blows per foot) and Moisture Content (%)						Other	Lithology	Soil Description Samples and descriptions are in recovered depths. Classification scheme: USCS	Lab Test
			1	2	5	10	20	50				



- ▲ SPT N-Value
- Moisture Content (%)

**Notes:**  
 %M=Percent Moisture Content, SG=Specific Gravity, ATT=Atterberg Limits, GSD=Grainsize Distribution, GSDH=Grainsize Distribution+Hydrometer, 1-D: One-dimensional Consolidation, CU=Unconsolidated Comp.  
 Mudline elevations determined from leadline measurements and Site tide gage levels

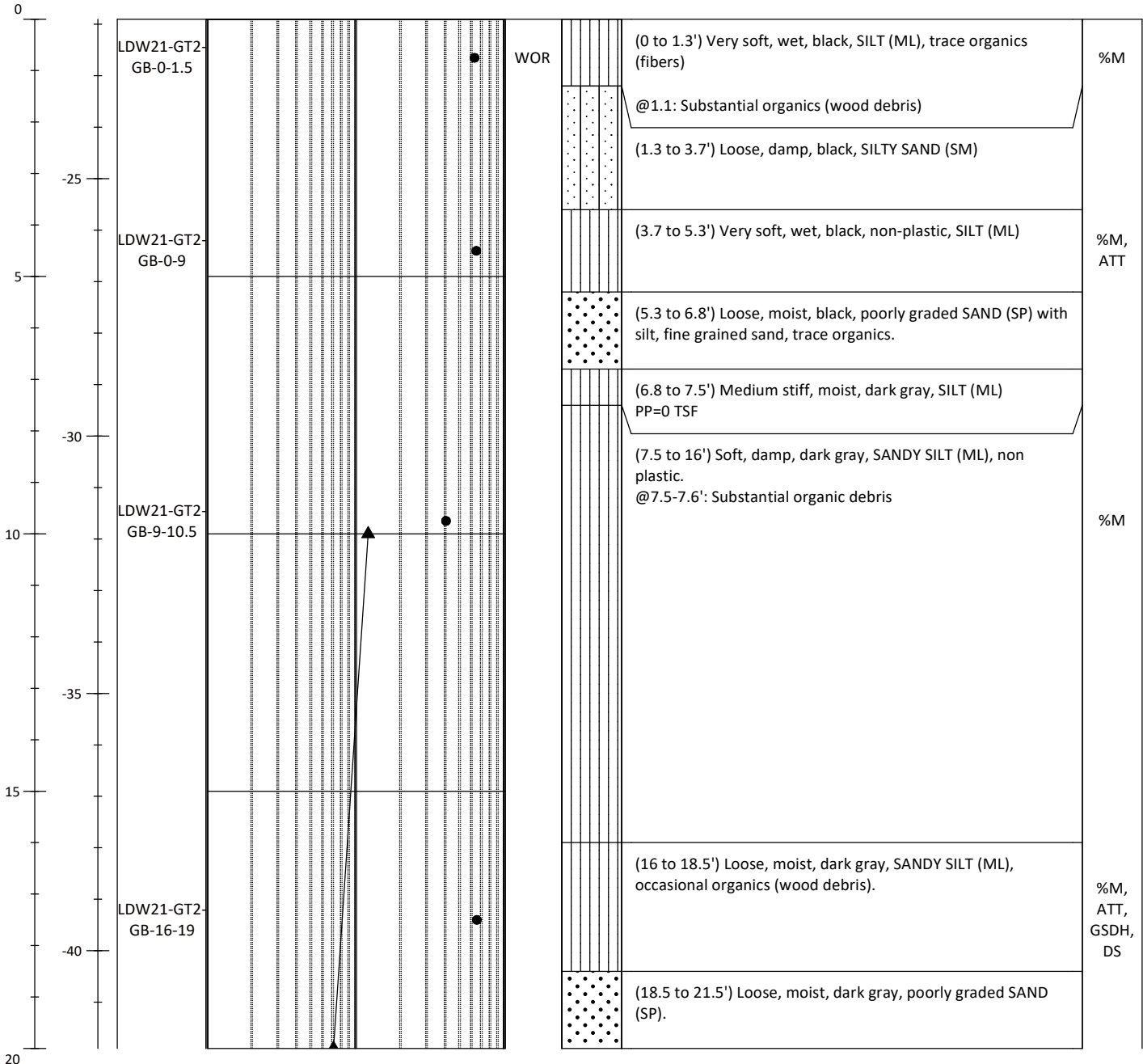
# [DRAFT] Soil Boring Log

## LDW21-GT2-GB

Sheet 1 of 2

Project #: <b>180067-02.03</b>	Project: <b>LDW Upper Reach Phase 2 Investigation</b>	Method: <b>Rotary Sonic</b>
Location: <b>Seattle, WA</b>	N/LAT: <b>197328.101</b> E/LONG: <b>1273794.399</b>	Total Depth (ft): <b>21.5</b>
Client: <b>Lower Duwamish Waterway Group</b>	Horiz. Datum: <b>Washington State Plane Coordinate North North American Datum of 1983, U.S. Feet</b>	Observed Depth to Mudline (ft): <b>23.2</b>
Collection Date: <b>07.09.21</b>		Mudline Elevation (ft): <b>-21.9</b>
Contractor: <b>Holocene Drilling, Inc</b>	Vert. Datum: <b>Mean Lower Low Water (MLLW)</b>	Hammer: <b>140-lb, 30-in drop, Auto</b>
Logged By: <b>Casey Janisch</b>	Sampler(s): <b>Split Spoon &amp; Shelby Tube Sampler</b>	Hammer Efficiency (%): <b>99</b>

Depth (ft)	Elevation (ft)	Sample ID	Uncorrected Standard Penetration Resistance (blows per foot) and Moisture Content (%)						Other	Lithology	Soil Description Samples and descriptions are in recovered depths. Classification scheme: USCS	Lab Test
			1	2	5	10	20	50				



- ▲ SPT N-Value
- Moisture Content (%)

**Notes:**  
 %M=Percent Moisture Content, SG=Specific Gravity, ATT=Atterberg Limits, GSD=Grainsize Distribution, GSDH=Grainsize Distribution+Hydrometer, 1-D: One-dimensional Consolidation, CU=Unconsolidated Comp. Mudline elevations determined from leadline measurements and Site tide gage levels

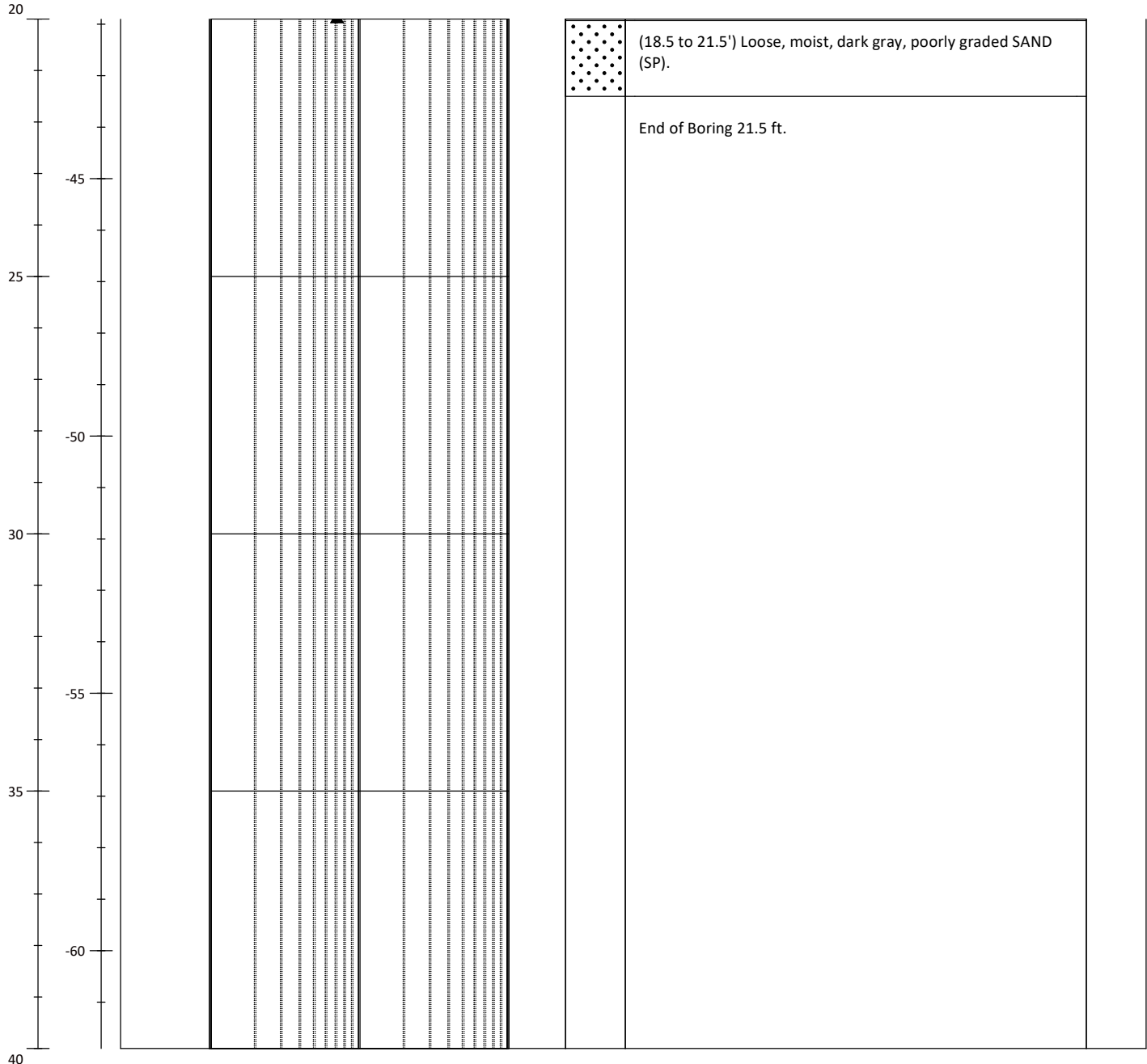
# [DRAFT] Soil Boring Log

## LDW21-GT2-GB

Sheet 2 of 2

Project #: <b>180067-02.03</b>	Project: <b>LDW Upper Reach Phase 2 Investigation</b>	Method: <b>Rotary Sonic</b>
Location: <b>Seattle, WA</b>	N/LAT: <b>197328.101</b> E/LONG: <b>1273794.399</b>	Total Depth (ft): <b>21.5</b>
Client: <b>Lower Duwamish Waterway Group</b>	Horiz. Datum: <b>Washington State Plane Coordinate North North American Datum of 1983, U.S. Feet</b>	Observed Depth to Mudline (ft): <b>23.2</b>
Collection Date: <b>07.09.21</b>		Mudline Elevation (ft): <b>-21.9</b>
Contractor: <b>Holocene Drilling, Inc</b>	Vert. Datum: <b>Mean Lower Low Water (MLLW)</b>	Hammer: <b>140-lb, 30-in drop, Auto</b>
Logged By: <b>Casey Janisch</b>	Sampler(s): <b>Split Spoon &amp; Shelby Tube Sampler</b>	Hammer Efficiency (%): <b>99</b>

Depth (ft)	Elevation (ft)	Sample ID	Uncorrected Standard Penetration Resistance (blows per foot) and Moisture Content (%)						Other	Lithology	Soil Description Samples and descriptions are in recovered depths. Classification scheme: USCS	Lab Test
			1	2	5	10	20	50				



<p style="font-size: small;">1201 Third Avenue Suite 2600 Seattle, WA 98101</p>	<ul style="list-style-type: none"> <li>▲ SPT N-Value</li> <li>● Moisture Content (%)</li> </ul>	<p><b>Notes:</b>                  %M=Percent Moisture Content, SG=Specific Gravity, ATT=Atterberg Limits, GSD=Grainsize Distribution, GSDH=Grainsize Distribution+Hydrometer, 1-D: One-dimensional Consolidation, CU=Unconsolidated Comp.                  Mudline elevations determined from leadline measurements and Site tide gage levels</p>
---	---	---

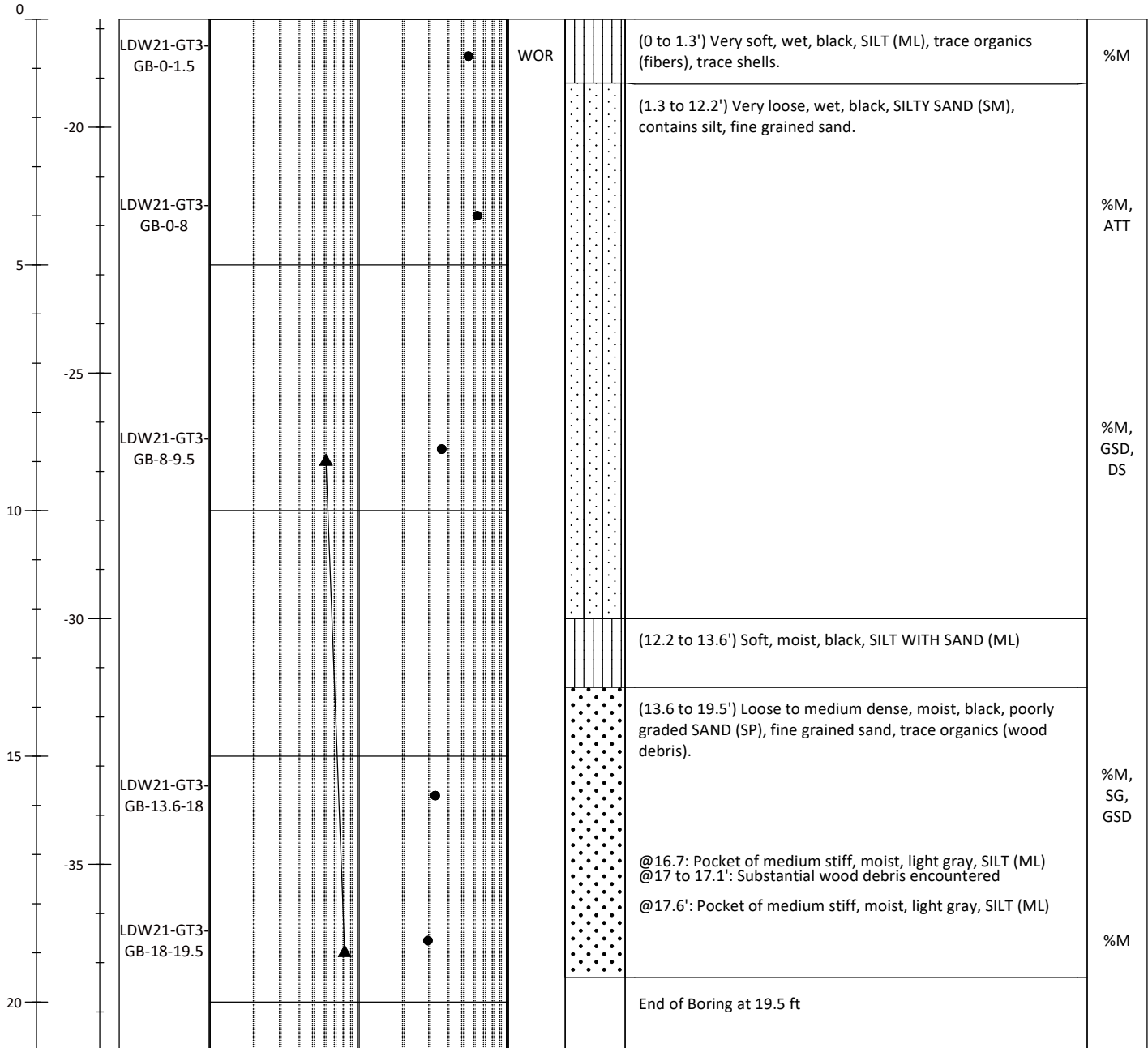
# [DRAFT] Soil Boring Log

## LDW21-GT3-GB

Sheet 1 of 1

Project #: <b>180067-02.03</b>	Project: <b>LDW Upper Reach Phase 2 Investigation</b>	Method: <b>Rotary Sonic</b>
Location: <b>Seattle, WA</b>	N/LAT: <b>196838.0251</b> E/LONG: <b>1274303.5483</b>	Total Depth (ft): <b>19.5</b>
Client: <b>Lower Duwamish Waterway Group</b>	Horiz. Datum: <b>Washington State Plane Coordinate North North American Datum of 1983, U.S. Feet</b>	Observed Depth to Mudline (ft): <b>18</b>
Collection Date: <b>07.14.21</b>		Mudline Elevation (ft): <b>-17.8</b>
Contractor: <b>Holocene Drilling, Inc</b>	Vert. Datum: <b>Mean Lower Low Water (MLLW)</b>	Hammer: <b>140-lb, 30-in drop, Auto</b>
Logged By: <b>Casey Janisch</b>	Sampler(s): <b>Split Spoon &amp; Shelby Tube Sampler</b>	Hammer Efficiency (%): <b>99</b>

Depth (ft)	Elevation (ft)	Sample ID	Uncorrected Standard Penetration Resistance (blows per foot) and Moisture Content (%)						Other	Lithology	Soil Description Samples and descriptions are in recovered depths. Classification scheme: USCS	Lab Test
			1	2	5	10	20	50				



- ▲ SPT N-Value
- Moisture Content (%)

**Notes:**  
 %M=Percent Moisture Content, SG=Specific Gravity, ATT=Atterberg Limits, GSD=Grainsize Distribution, GSDH=Grainsize Distribution+Hydrometer, 1-D: One-dimensional Consolidation, CU=Unconsolidated Comp. Mudline elevations determined from leadline measurements and Site tide gage levels

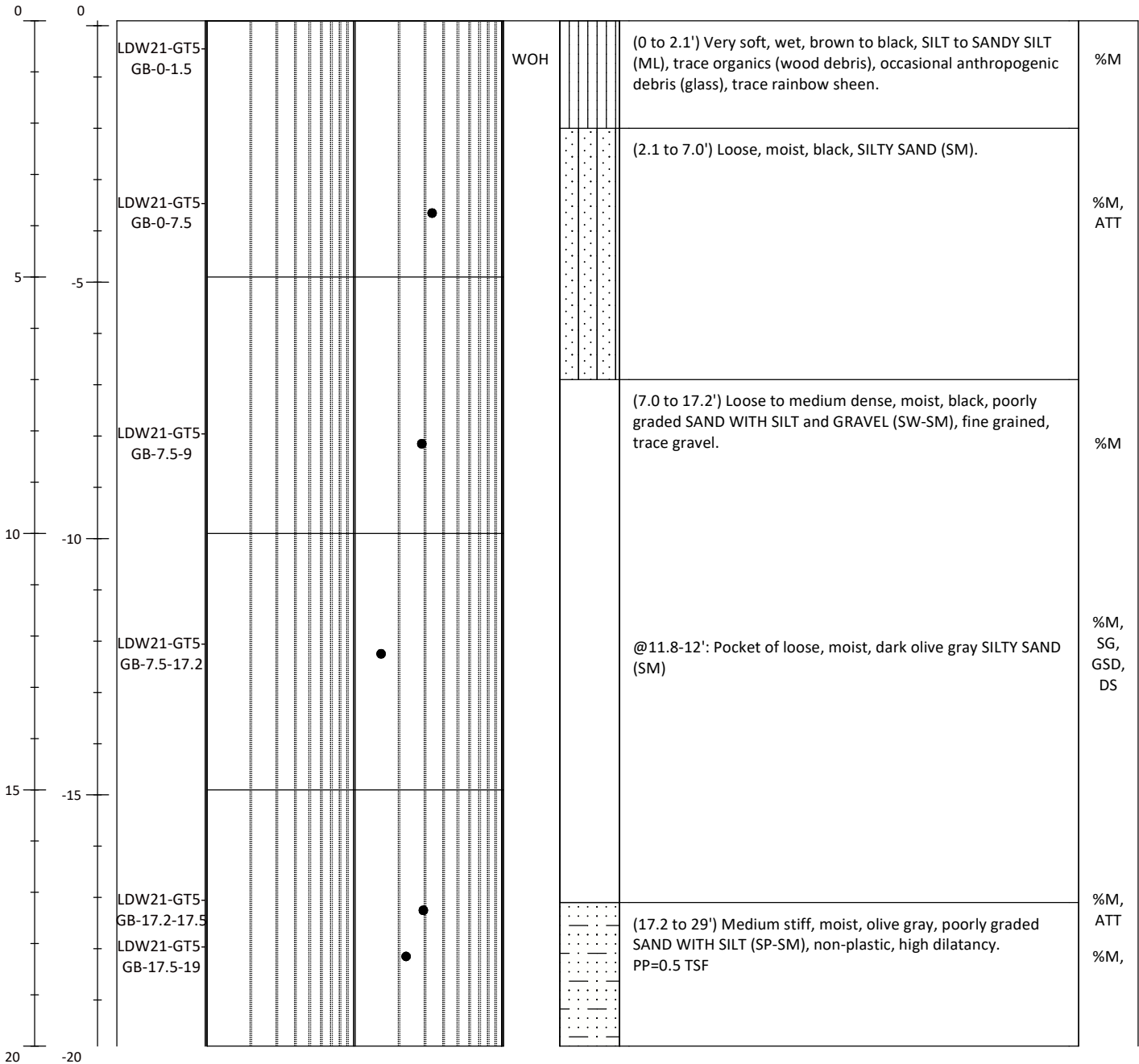
# [DRAFT] Soil Boring Log

## LDW21-GT5-GB

Sheet 1 of 2

Project #: <b>180067-02.03</b>	Project: <b>LDW Upper Reach Phase 2 Investigation</b>	Method: <b>Rotary Sonic</b>
Location: <b>Seattle, WA</b>	N/LAT: <b>196515.647</b> E/LONG: <b>1274408.737</b>	Total Depth (ft): <b>29</b>
Client: <b>Lower Duwamish Waterway Group</b>	Horiz. Datum: <b>Washington State Plane Coordinate North North American Datum of 1983, U.S. Feet</b>	Observed Depth to Mudline (ft): <b>8.5</b>
Collection Date: <b>07.19.21</b>		Mudline Elevation (ft): <b>0.1</b>
Contractor: <b>Holocene Drilling, Inc</b>	Vert. Datum: <b>Mean Lower Low Water (MLLW)</b>	Hammer: <b>140-lb, 30-in drop, Auto</b>
Logged By: <b>Casey Janisch</b>	Sampler(s): <b>Split Spoon &amp; Shelby Tube Sampler</b>	Hammer Efficiency (%): <b>99</b>

Depth (ft)	Elevation (ft)	Sample ID	Uncorrected Standard Penetration Resistance (blows per foot) and Moisture Content (%)						Other	Lithology	Soil Description Samples and descriptions are in recovered depths. Classification scheme: USCS	Lab Test
			1	2	5	10	20	50				



- ▲ SPT N-Value
- Moisture Content (%)

**Notes:**  
 %M=Percent Moisture Content, SG=Specific Gravity, ATT=Atterberg Limits, GSD=Grainsize Distribution, GSDH=Grainsize Distribution+Hydrometer, 1-D: One-dimensional Consolidation, CU=Unconsolidated Comp. Mudline elevations determined from leadline measurements and Site tide gage levels

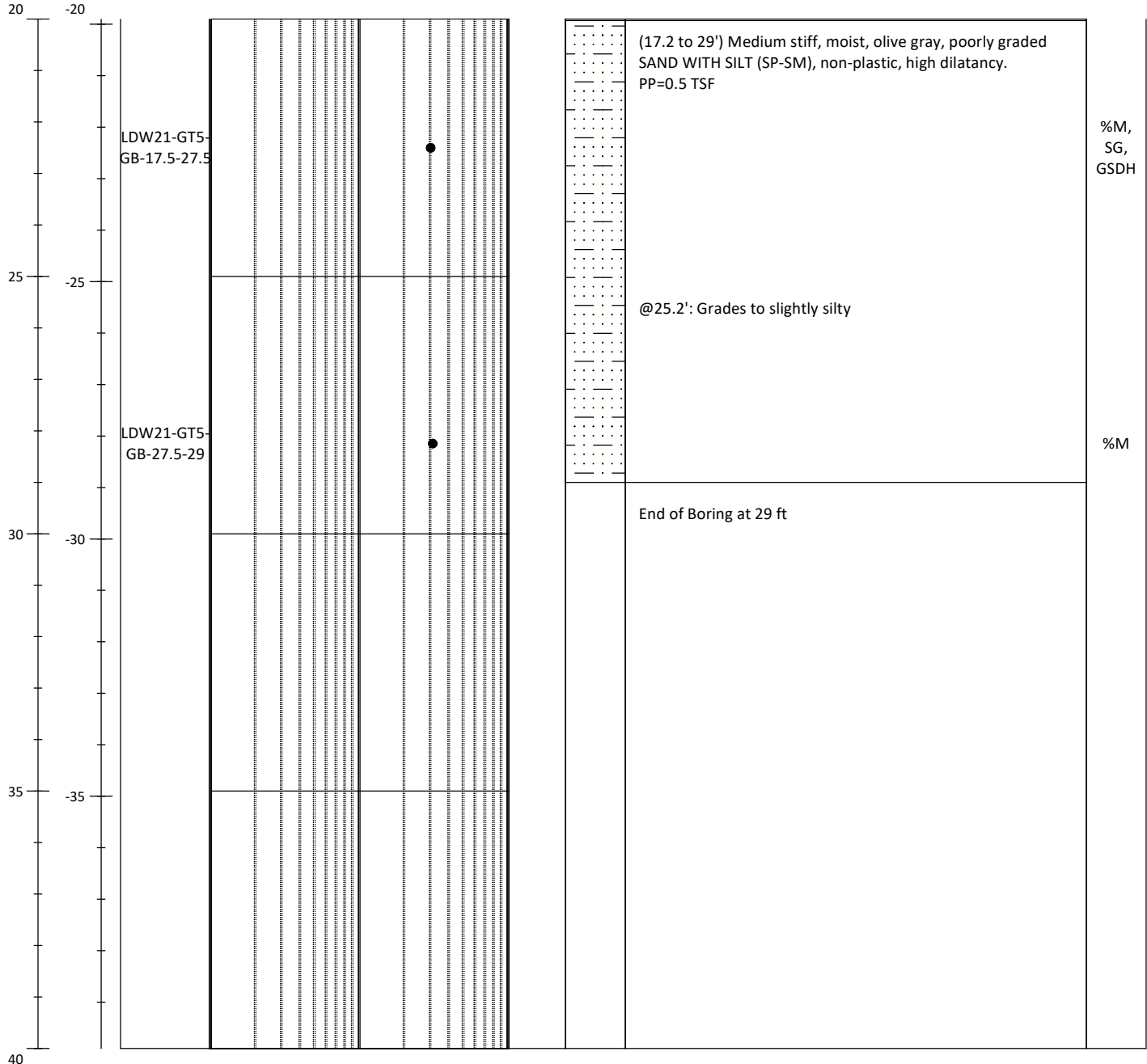
# [DRAFT] Soil Boring Log

## LDW21-GT5-GB

Sheet 2 of 2

Project #: <b>180067-02.03</b>	Project: <b>LDW Upper Reach Phase 2 Investigation</b>	Method: <b>Rotary Sonic</b>
Location: <b>Seattle, WA</b>	N/LAT: <b>196515.647</b> E/LONG: <b>1274408.737</b>	Total Depth (ft): <b>29</b>
Client: <b>Lower Duwamish Waterway Group</b>	Horiz. Datum: <b>Washington State Plane Coordinate North North American Datum of 1983, U.S. Feet</b>	Observed Depth to Mudline (ft): <b>8.5</b>
Collection Date: <b>07.19.21</b>		Mudline Elevation (ft): <b>0.1</b>
Contractor: <b>Holocene Drilling, Inc</b>	Vert. Datum: <b>Mean Lower Low Water (MLLW)</b>	Hammer: <b>140-lb, 30-in drop, Auto</b>
Logged By: <b>Casey Janisch</b>	Sampler(s): <b>Split Spoon &amp; Shelby Tube Sampler</b>	Hammer Efficiency (%): <b>99</b>

Depth (ft)	Elevation (ft)	Sample ID	Uncorrected Standard Penetration Resistance (blows per foot) and Moisture Content (%)						Other	Lithology	Soil Description Samples and descriptions are in recovered depths. Classification scheme: USCS	Lab Test
			1	2	5	10	20	50				



- ▲ SPT N-Value
- Moisture Content (%)

**Notes:**  
 %M=Percent Moisture Content, SG=Specific Gravity, ATT=Atterberg Limits, GSD=Grainsize Distribution, GSDH=Grainsize Distribution+Hydrometer, 1-D: One-dimensional Consolidation, CU=Unconsolidated Comp. Mudline elevations determined from leadline measurements and Site tide gage levels

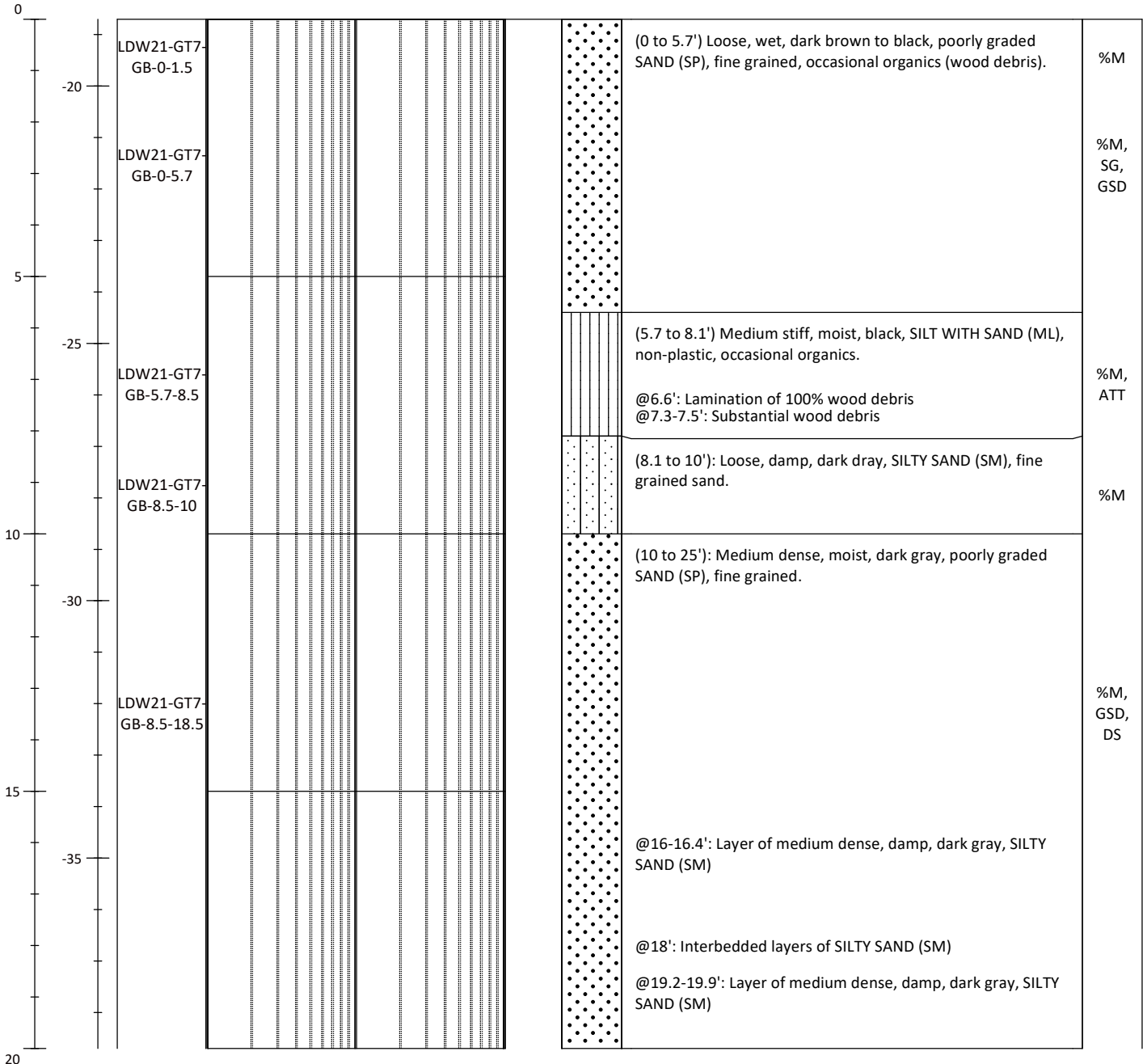
# [DRAFT] Soil Boring Log

## LDW21-GT7-GB

Sheet 1 of 2

Project #: <b>180067-02.03</b>	Project: <b>LDW Upper Reach Phase 2 Investigation</b>	Method: <b>Rotary Sonic</b>
Location: <b>Seattle, WA</b>	N/LAT: <b>196544.595</b> E/LONG: <b>1274698.428</b>	Total Depth (ft): <b>25</b>
Client: <b>Lower Duwamish Waterway Group</b>	Horiz. Datum: <b>Washington State Plane Coordinate North North American Datum of 1983, U.S. Feet</b>	Observed Depth to Mudline (ft): <b>17.5</b>
Collection Date: <b>07.09.21</b>		Mudline Elevation (ft): <b>-18.7</b>
Contractor: <b>Holocene Drilling, Inc</b>	Vert. Datum: <b>Mean Lower Low Water (MLLW)</b>	Hammer: <b>140-lb, 30-in drop, Auto</b>
Logged By: <b>Casey Janisch</b>	Sampler(s): <b>Split Spoon &amp; Shelby Tube Sampler</b>	Hammer Efficiency (%): <b>99</b>

Depth (ft)	Elevation (ft)	Sample ID	Uncorrected Standard Penetration Resistance (blows per foot) and Moisture Content (%)						Other	Lithology	Soil Description Samples and descriptions are in recovered depths. Classification scheme: USCS	Lab Test
			1	2	5	10	20	50				



- ▲ SPT N-Value
- Moisture Content (%)

**Notes:**  
 %M=Percent Moisture Content, SG=Specific Gravity, ATT=Atterberg Limits, GSD=Grainsize Distribution, GSDH=Grainsize Distribution+Hydrometer, 1-D: One-dimensional Consolidation, CU=Unconsolidated Comp  
 Mudline elevations determined from leadline measurements and Site tide gage levels

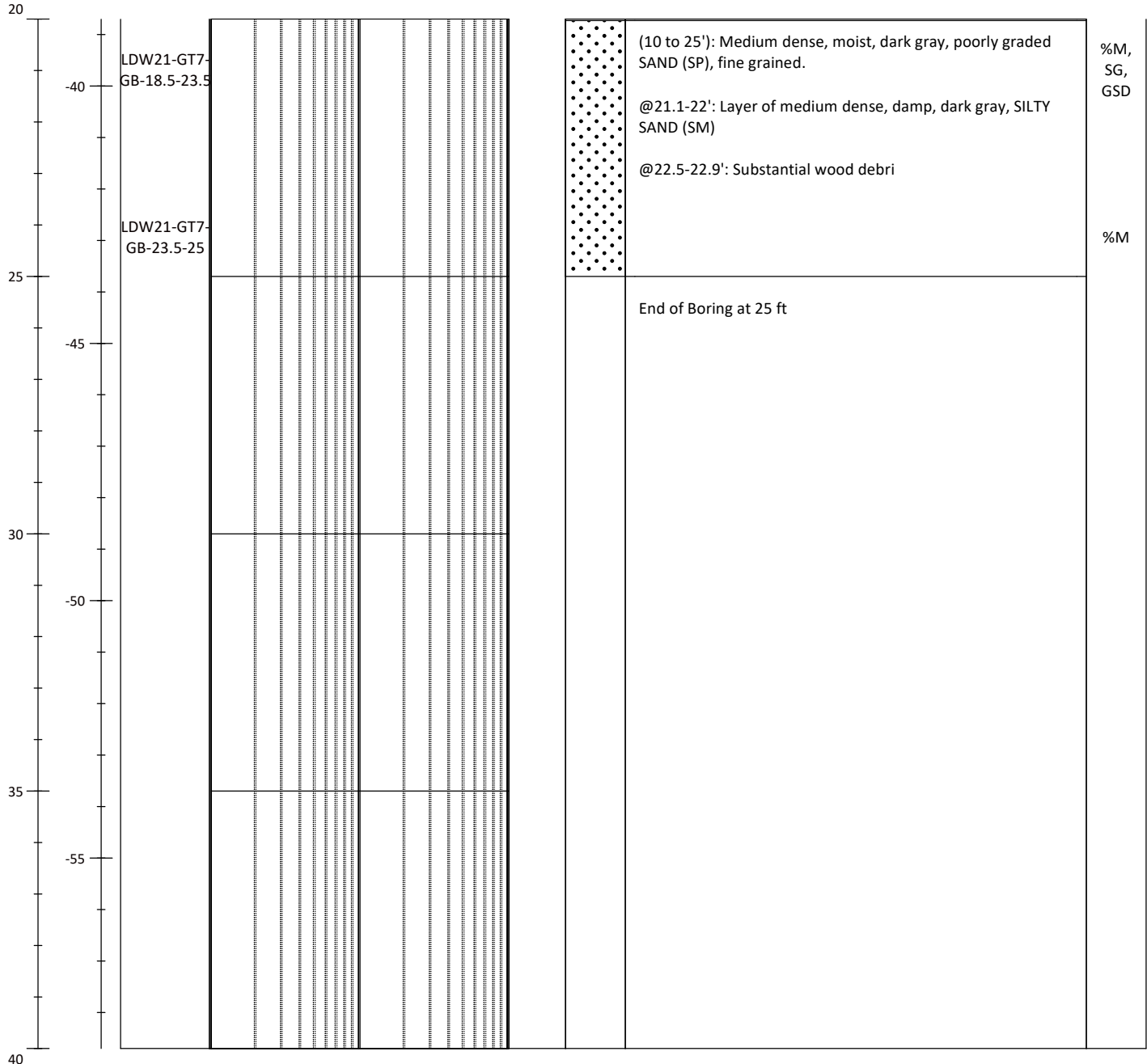


# [DRAFT] Soil Boring Log

## LDW21-GT7-GB

Project #: <b>180067-02.03</b>	Project: <b>LDW Upper Reach Phase 2 Investigation</b>	Method: <b>Rotary Sonic</b>
Location: <b>Seattle, WA</b>	N/LAT: <b>196544.595</b> E/LONG: <b>1274698.428</b>	Total Depth (ft): <b>25</b>
Client: <b>Lower Duwamish Waterway Group</b>	Horiz. Datum: <b>Washington State Plane Coordinate North North American Datum of 1983, U.S. Feet</b>	Observed Depth to Mudline (ft): <b>17.5</b>
Collection Date: <b>07.09.21</b>		Mudline Elevation (ft): <b>-18.7</b>
Contractor: <b>Holocene Drilling, Inc</b>	Vert. Datum: <b>Mean Lower Low Water (MLLW)</b>	Hammer: <b>140-lb, 30-in drop, Auto</b>
Logged By: <b>Casey Janisch</b>	Sampler(s): <b>Split Spoon &amp; Shelby Tube Sampler</b>	Hammer Efficiency (%): <b>99</b>

Depth (ft)	Elevation (ft)	Sample ID	Uncorrected Standard Penetration Resistance (blows per foot) and Moisture Content (%)						Other	Lithology	Soil Description Samples and descriptions are in recovered depths. Classification scheme: USCS	Lab Test
			1	2	5	10	20	50				



- ▲ SPT N-Value
- Moisture Content (%)

**Notes:**  
 %M=Percent Moisture Content, SG=Specific Gravity, ATT=Atterberg Limits, GSD=Grainsize Distribution, GSDH=Grainsize Distribution+Hydrometer, 1-D: One-dimensional Consolidation, CU=Unconsolidated Comp. Mudline elevations determined from leadline measurements and Site tide gage levels

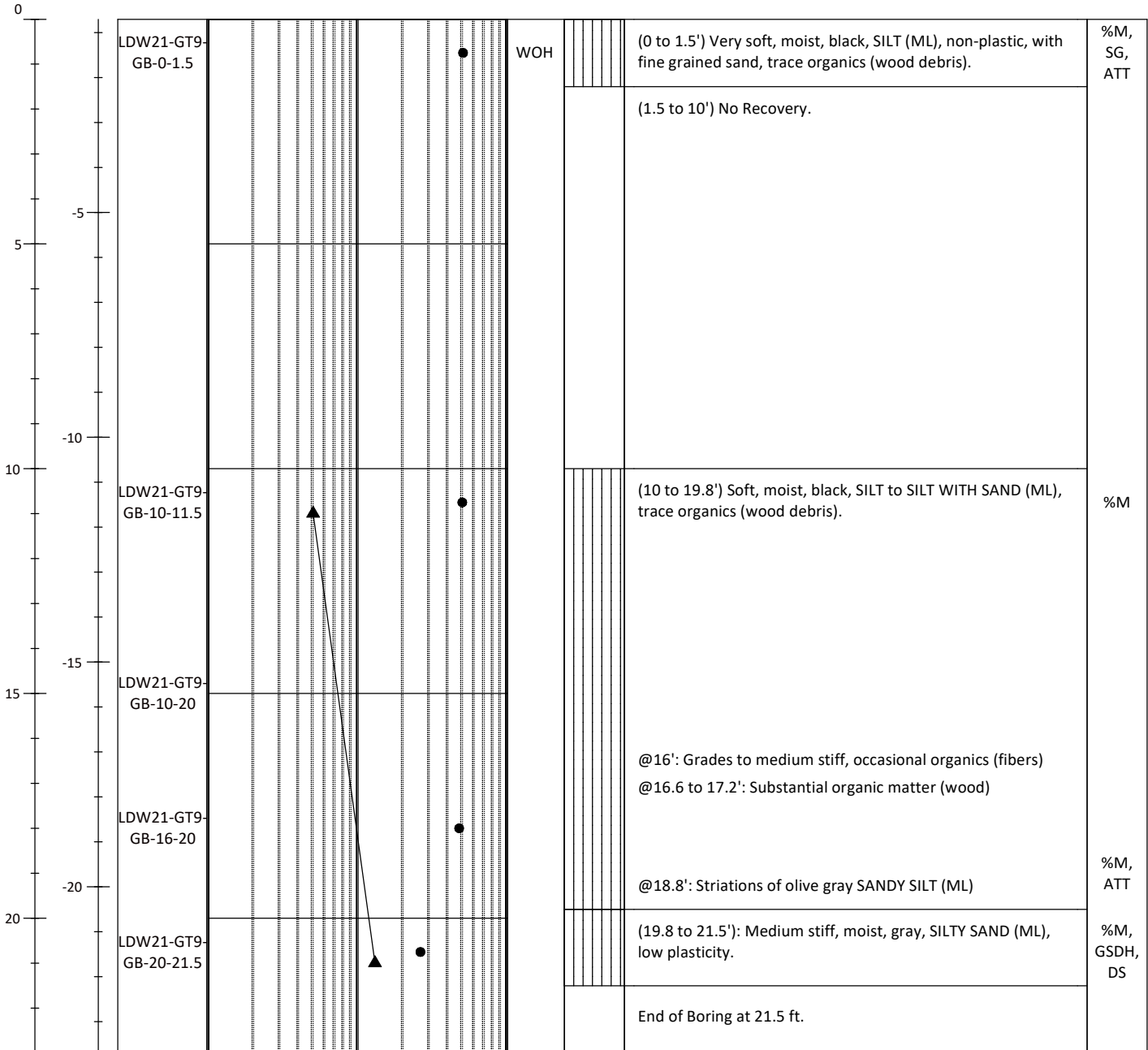
# [DRAFT] Soil Boring Log

## LDW21-GT9-GB

Sheet 1 of 1

Project #: <b>180067-02.03</b>	Project: <b>LDW Upper Reach Phase 2 Investigation</b>	Method: <b>Rotary Sonic</b>
Location: <b>Seattle, WA</b>	N/LAT: <b>195927.181</b> E/LONG: <b>1275283.558</b>	Total Depth (ft): <b>21.5</b>
Client: <b>Lower Duwamish Waterway Group</b>	Horiz. Datum: <b>Washington State Plane Coordinate North North American Datum of 1983, U.S. Feet</b>	Observed Depth to Mudline (ft): <b>11.2</b>
Collection Date: <b>07.08.21</b>		Mudline Elevation (ft): <b>-0.7</b>
Contractor: <b>Holocene Drilling, Inc</b>	Vert. Datum: <b>Mean Lower Low Water (MLLW)</b>	Hammer: <b>140-lb, 30-in drop, Auto</b>
Logged By: <b>Casey Janisch</b>	Sampler(s): <b>Split Spoon &amp; Shelby Tube Sampler</b>	Hammer Efficiency (%): <b>99</b>

Depth (ft)	Elevation (ft)	Sample ID	Uncorrected Standard Penetration Resistance (blows per foot) and Moisture Content (%)						Other	Lithology	Soil Description Samples and descriptions are in recovered depths. Classification scheme: USCS	Lab Test
			1	2	5	10	20	50				



- ▲ SPT N-Value
- Moisture Content (%)

**Notes:**  
 %M=Percent Moisture Content, SG=Specific Gravity, ATT=Atterberg Limits, GSD=Grainsize Distribution, GSDH=Grainsize Distribution+Hydrometer, 1-D: One-dimensional Consolidation, CU=Unconsolidated Comp. Mudline elevations determined from leadline measurements and Site tide gage levels

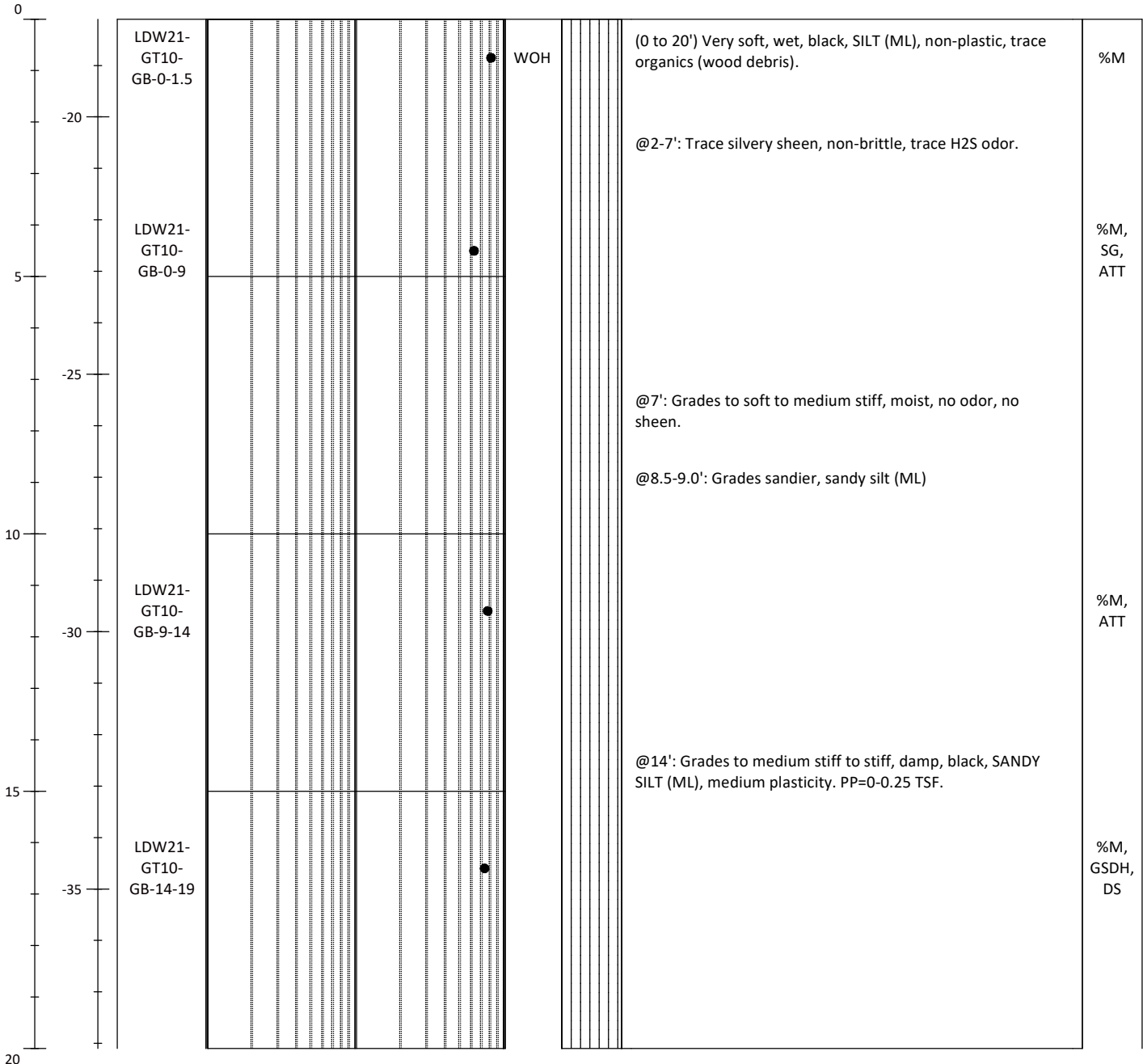
# [DRAFT] Soil Boring Log

## LDW21-GT10-GB

Sheet 1 of 2

Project #: <b>180067-02.03</b>	Project: <b>LDW Upper Reach Phase 2 Investigation</b>	Method: <b>Rotary Sonic</b>
Location: <b>Seattle, WA</b>	N/LAT: <b>195631.266</b> E/LONG: <b>1275691.841</b>	Total Depth (ft): <b>25.5</b>
Client: <b>Lower Duwamish Waterway Group</b>	Horiz. Datum: <b>Washington State Plane Coordinate North North American Datum of 1983, U.S. Feet</b>	Observed Depth to Mudline (ft): <b>18.2</b>
Collection Date: <b>07.07.21</b>		Mudline Elevation (ft): <b>-18.1</b>
Contractor: <b>Holocene Drilling, Inc</b>	Vert. Datum: <b>Mean Lower Low Water (MLLW)</b>	Hammer: <b>140-lb, 30-in drop, Auto</b>
Logged By: <b>Casey Janisch</b>	Sampler(s): <b>Split Spoon &amp; Shelby Tube Sampler</b>	Hammer Efficiency (%): <b>99</b>

Depth (ft)	Elevation (ft)	Sample ID	Uncorrected Standard Penetration Resistance (blows per foot) and Moisture Content (%)						Other	Lithology	Soil Description Samples and descriptions are in recovered depths. Classification scheme: USCS	Lab Test
			1	2	5	10	20	50				



- ▲ SPT N-Value
- Moisture Content (%)

**Notes:**  
 %M=Percent Moisture Content, SG=Specific Gravity, ATT=Atterberg Limits, GSD=Grainsize Distribution, GSDH=Grainsize Distribution+Hydrometer, 1-D: One-dimensional Consolidation, CU=Unconsolidated Comp. Mudline elevations determined from leadline measurements and Site tide gage levels

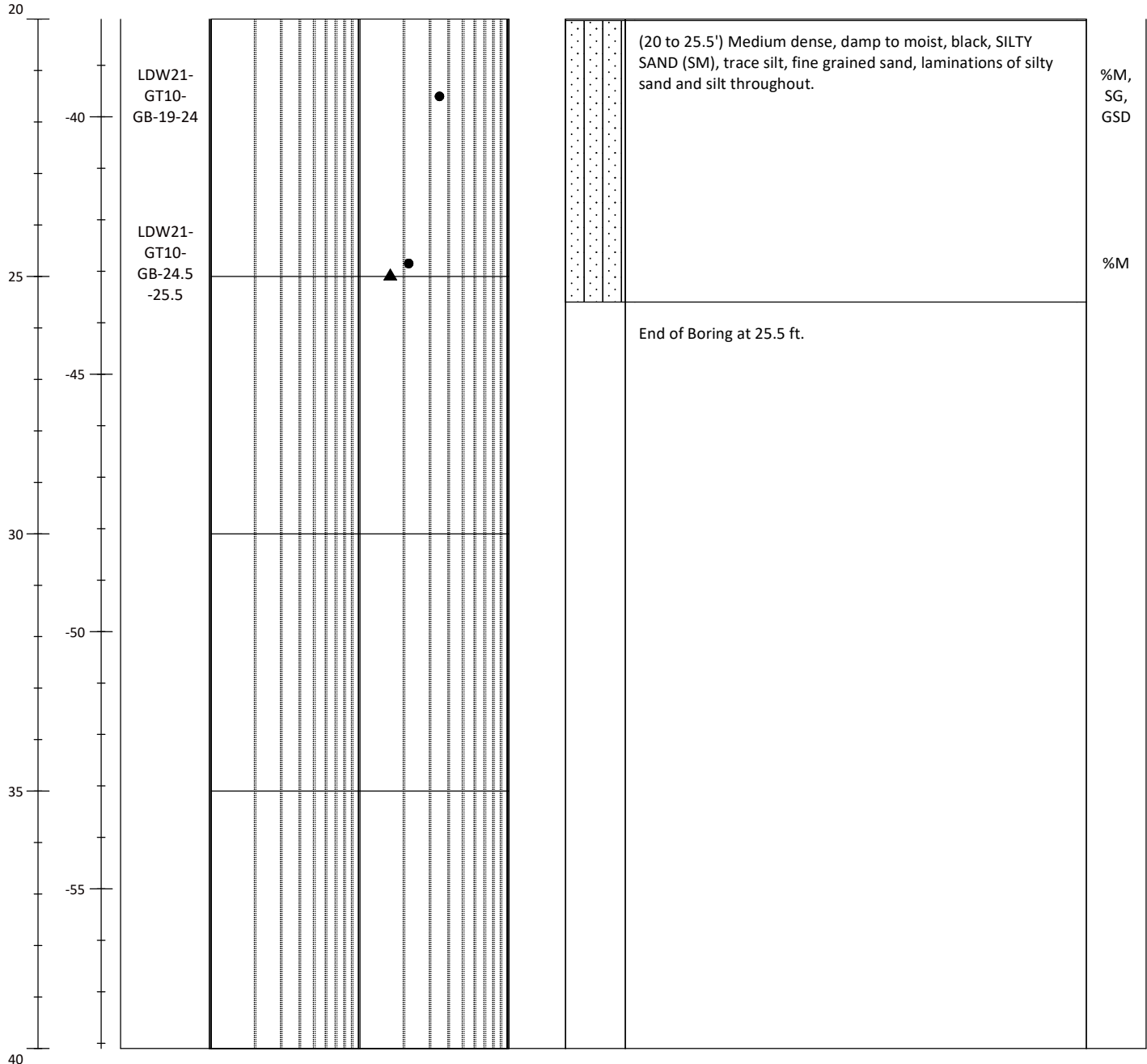
# [DRAFT] Soil Boring Log

## LDW21-GT10-GB

Sheet 2 of 2

Project #: <b>180067-02.03</b>	Project: <b>LDW Upper Reach Phase 2 Investigation</b>	Method: <b>Rotary Sonic</b>
Location: <b>Seattle, WA</b>	N/LAT: <b>195631.266</b> E/LONG: <b>1275691.841</b>	Total Depth (ft): <b>25.5</b>
Client: <b>Lower Duwamish Waterway Group</b>	Horiz. Datum: <b>Washington State Plane Coordinate North North American Datum of 1983, U.S. Feet</b>	Observed Depth to Mudline (ft): <b>18.2</b>
Collection Date: <b>07.07.21</b>		Mudline Elevation (ft): <b>-18.1</b>
Contractor: <b>Holocene Drilling, Inc</b>	Vert. Datum: <b>Mean Lower Low Water (MLLW)</b>	Hammer: <b>140-lb, 30-in drop, Auto</b>
Logged By: <b>Casey Janisch</b>	Sampler(s): <b>Split Spoon &amp; Shelby Tube Sampler</b>	Hammer Efficiency (%): <b>99</b>

Depth (ft)	Elevation (ft)	Sample ID	Uncorrected Standard Penetration Resistance (blows per foot) and Moisture Content (%)						Other	Lithology	Soil Description Samples and descriptions are in recovered depths. Classification scheme: USCS	Lab Test
			1	2	5	10	20	50				



- ▲ SPT N-Value
- Moisture Content (%)

**Notes:**  
 %M=Percent Moisture Content, SG=Specific Gravity, ATT=Atterberg Limits, GSD=Grainsize Distribution, GSDH=Grainsize Distribution+Hydrometer, 1-D: One-dimensional Consolidation, CU=Unconsolidated Comp. Mudline elevations determined from leadline measurements and Site tide gage levels

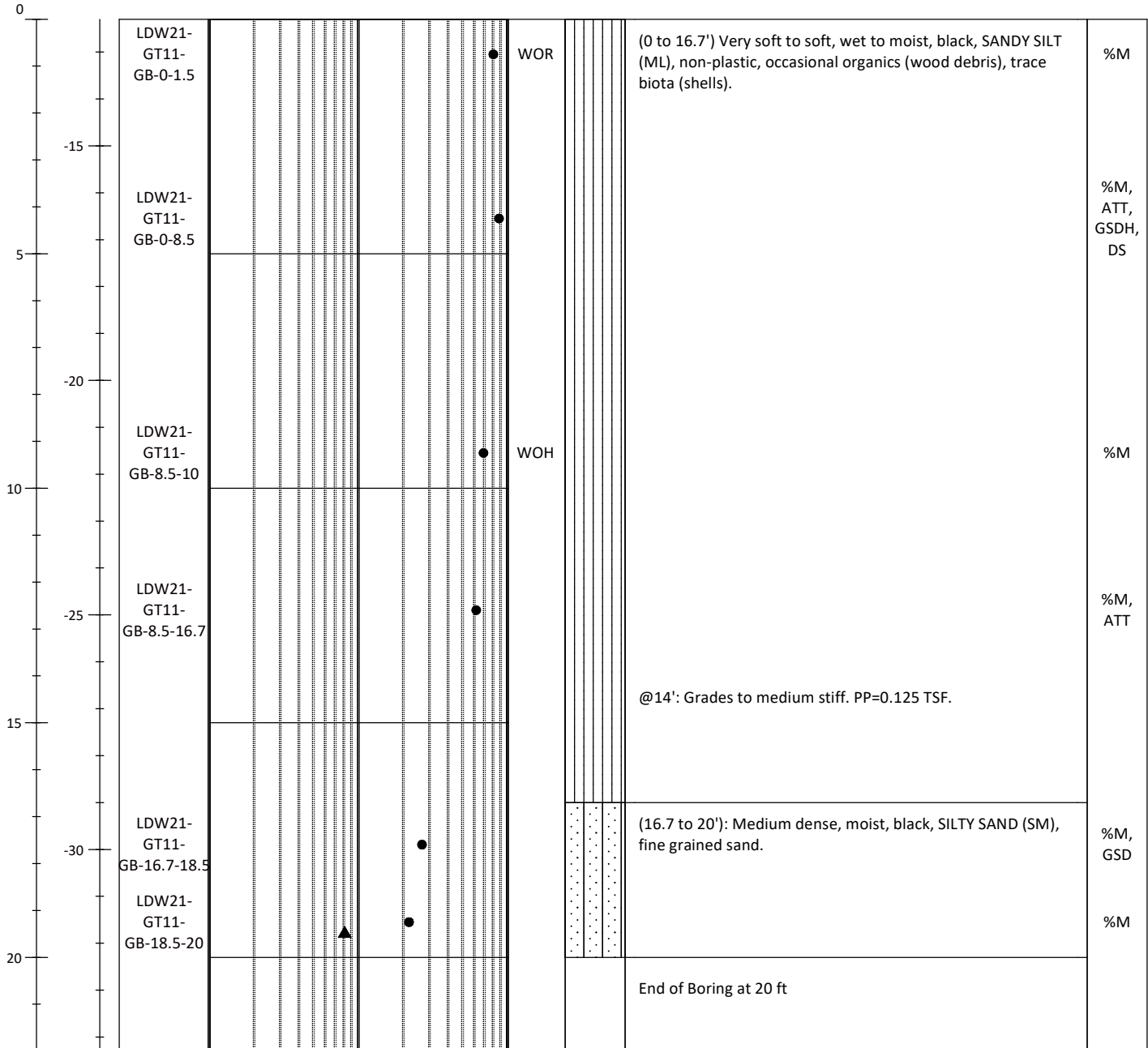
# [DRAFT] Soil Boring Log

## LDW21-GT11-GB

Sheet 1 of 1

Project #: <b>180067-02.03</b>	Project: <b>LDW Upper Reach Phase 2 Investigation</b>	Method: <b>Rotary Sonic</b>
Location: <b>Seattle, WA</b>	N/LAT: <b>195423.544</b> E/LONG: <b>1275688.731</b>	Total Depth (ft): <b>20</b>
Client: <b>Lower Duwamish Waterway Group</b>	Horiz. Datum: <b>Washington State Plane Coordinate North North American Datum of 1983, U.S. Feet</b>	Observed Depth to Mudline (ft): <b>18.7</b>
Collection Date: <b>07.08.21</b>		Mudline Elevation (ft): <b>-12.3</b>
Contractor: <b>Holocene Drilling, Inc</b>	Vert. Datum: <b>Mean Lower Low Water (MLLW)</b>	Hammer: <b>140-lb, 30-in drop, Auto</b>
Logged By: <b>Casey Janisch</b>	Sampler(s): <b>Split Spoon &amp; Shelby Tube Sampler</b>	Hammer Efficiency (%): <b>99</b>

Depth (ft)	Elevation (ft)	Sample ID	Uncorrected Standard Penetration Resistance (blows per foot) and Moisture Content (%)						Other	Lithology	Soil Description Samples and descriptions are in recovered depths. Classification scheme: USCS	Lab Test
			1	2	5	10	20	50				



- ▲ SPT N-Value
- Moisture Content (%)

**Notes:**  
 %M=Percent Moisture Content, SG=Specific Gravity, ATT=Atterberg Limits, GSD=Grainsize Distribution, GSDH=Grainsize Distribution+Hydrometer, 1-D: One-dimensional Consolidation, CU=Unconsolidated Comp. Mudline elevations determined from leadline measurements and Site tide gage levels

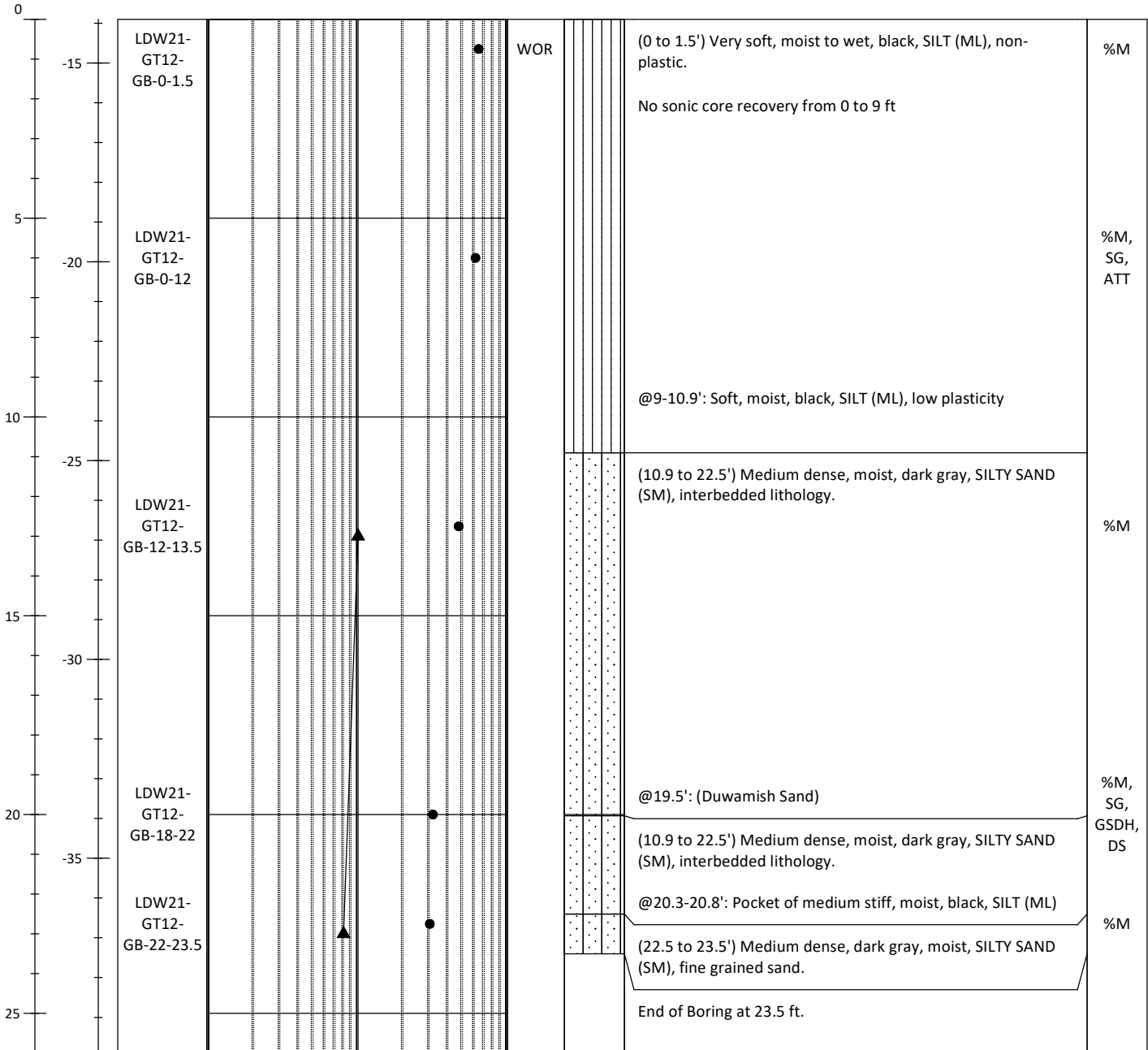
# [DRAFT] Soil Boring Log

## LDW21-GT12-GB

Sheet 1 of 1

Project #: <b>180067-02.03</b>	Project: <b>LDW Upper Reach Phase 2 Investigation</b>	Method: <b>Rotary Sonic</b>
Location: <b>Seattle, WA</b>	N/LAT: <b>195269.116</b> E/LONG: <b>1275845.395</b>	Total Depth (ft): <b>23.5</b>
Client: <b>Lower Duwamish Waterway Group</b>	Horiz. Datum: <b>Washington State Plane Coordinate North North American Datum of 1983, U.S. Feet</b>	Observed Depth to Mudline (ft): <b>15.2</b>
Collection Date: <b>07.08.21</b>		Mudline Elevation (ft): <b>-13.9</b>
Contractor: <b>Holocene Drilling, Inc</b>	Vert. Datum: <b>Mean Lower Low Water (MLLW)</b>	Hammer: <b>140-lb, 30-in drop, Auto</b>
Logged By: <b>Casey Janisch</b>	Sampler(s): <b>Split Spoon &amp; Shelby Tube Sampler</b>	Hammer Efficiency (%): <b>99</b>

Depth (ft)	Elevation (ft)	Sample ID	Uncorrected Standard Penetration Resistance (blows per foot) and Moisture Content (%)						Other	Lithology	Soil Description Samples and descriptions are in recovered depths. Classification scheme: USCS	Lab Test
			1	2	5	10	20	50				



- ▲ SPT N-Value
- Moisture Content (%)

**Notes:**  
 %M=Percent Moisture Content, SG=Specific Gravity, ATT=Atterberg Limits, GSD=Grainsize Distribution, GSDH=Grainsize Distribution+Hydrometer, 1-D: One-dimensional Consolidation, CU=Unconsolidated Comp. Mudline elevations determined from leadline measurements and Site tide gage levels

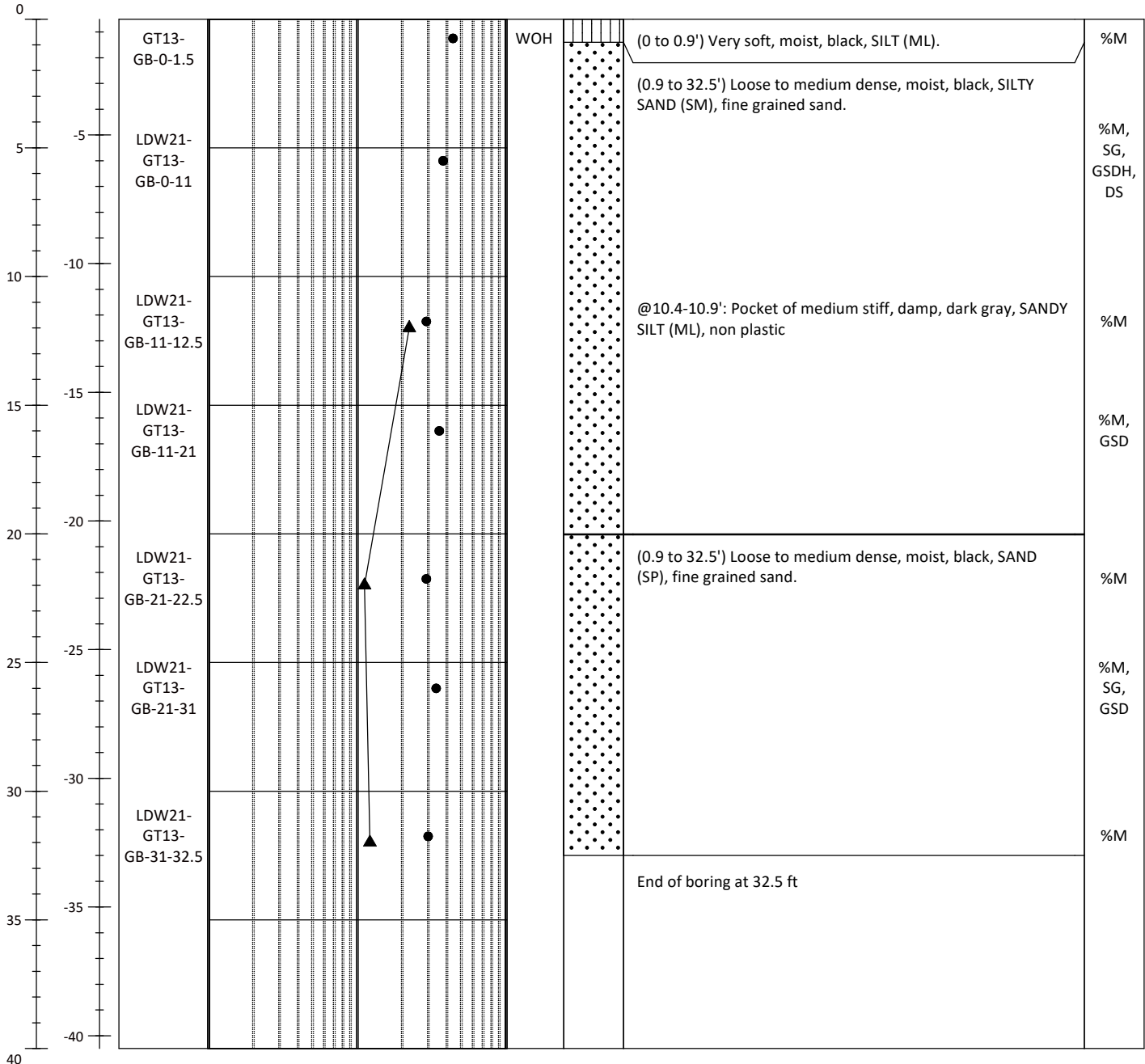
# [DRAFT] Soil Boring Log

## LDW21-GT13-GB

Sheet 1 of 1

Project #: <b>180067-02.03</b>	Project: <b>LDW Upper Reach Phase 2 Investigation</b>	Method: <b>Rotary Sonic</b>
Location: <b>Seattle, WA</b>	N/LAT: <b>195063.55</b> E/LONG: <b>1276022.385</b>	Total Depth (ft): <b>32.5</b>
Client: <b>Lower Duwamish Waterway Group</b>	Horiz. Datum: <b>Washington State Plane Coordinate North North American Datum of 1983, U.S. Feet</b>	Observed Depth to Mudline (ft): <b>5.0</b>
Collection Date: <b>07.12.21</b>		Mudline Elevation (ft): <b>-0.5</b>
Contractor: <b>Holocene Drilling, Inc</b>	Vert. Datum: <b>Mean Lower Low Water (MLLW)</b>	Hammer: <b>140-lb, 30-in drop, Auto</b>
Logged By: <b>Casey Janisch</b>	Sampler(s): <b>Split Spoon &amp; Shelby Tube Sampler</b>	Hammer Efficiency (%): <b>99</b>

Depth (ft)	Elevation (ft)	Sample ID	Uncorrected Standard Penetration Resistance (blows per foot) and Moisture Content (%)						Other	Lithology	Soil Description Samples and descriptions are in recovered depths. Classification scheme: USCS	Lab Test
			1	2	5	10	20	50				



- ▲ SPT N-Value
- Moisture Content (%)

**Notes:**  
 %M=Percent Moisture Content, SG=Specific Gravity, ATT=Atterberg Limits, GSD=Grainsize Distribution, GSDH=Grainsize Distribution+Hydrometer, 1-D: One-dimensional Consolidation, CU=Unconsolidated Comp.  
 Mudline elevations determined from leadline measurements and Site tide gage levels

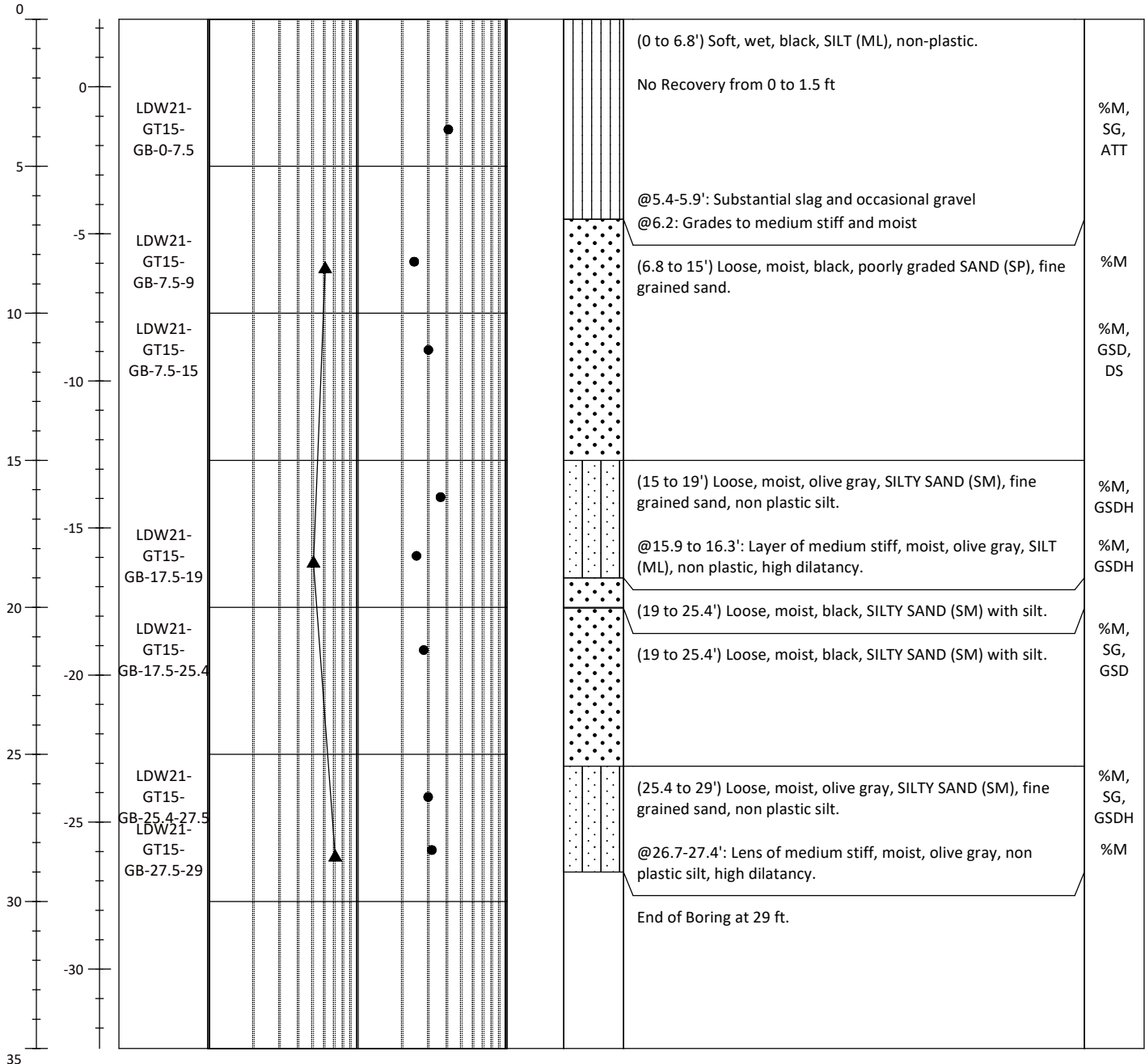
# [DRAFT] Soil Boring Log

## LDW21-GT15-GB

Sheet 1 of 1

Project #: <b>180067-02.03</b>	Project: <b>LDW Upper Reach Phase 2 Investigation</b>	Method: <b>Rotary Sonic</b>
Location: <b>Seattle, WA</b>	N/LAT: <b>194770.977</b> E/LONG: <b>1276096.292</b>	Total Depth (ft): <b>29</b>
Client: <b>Lower Duwamish Waterway Group</b>	Horiz. Datum: <b>Washington State Plane Coordinate North North American Datum of 1983, U.S. Feet</b>	Observed Depth to Mudline (ft): <b>7.5</b>
Collection Date: <b>07.12.21</b>		Mudline Elevation (ft): <b>2.3</b>
Contractor: <b>Holocene Drilling, Inc</b>	Vert. Datum: <b>Mean Lower Low Water (MLLW)</b>	Hammer: <b>140-lb, 30-in drop, Auto</b>
Logged By: <b>Casey Janisch</b>	Sampler(s): <b>Split Spoon &amp; Shelby Tube Sampler</b>	Hammer Efficiency (%): <b>99</b>

Depth (ft)	Elevation (ft)	Sample ID	Uncorrected Standard Penetration Resistance (blows per foot) and Moisture Content (%)						Other	Lithology	Soil Description Samples and descriptions are in recovered depths. Classification scheme: USCS	Lab Test
			1	2	5	10	20	50				



- ▲ SPT N-Value
- Moisture Content (%)

**Notes:**

%M=Percent Moisture Content, SG=Specific Gravity, ATT=Atterberg Limits, GSD=Grainsize Distribution, GSDH=Grainsize Distribution+Hydrometer, 1-D: One-dimensional Consolidation, CU=Unconsolidated Comp. Mudline elevations determined from leadline measurements and Site tide gage levels



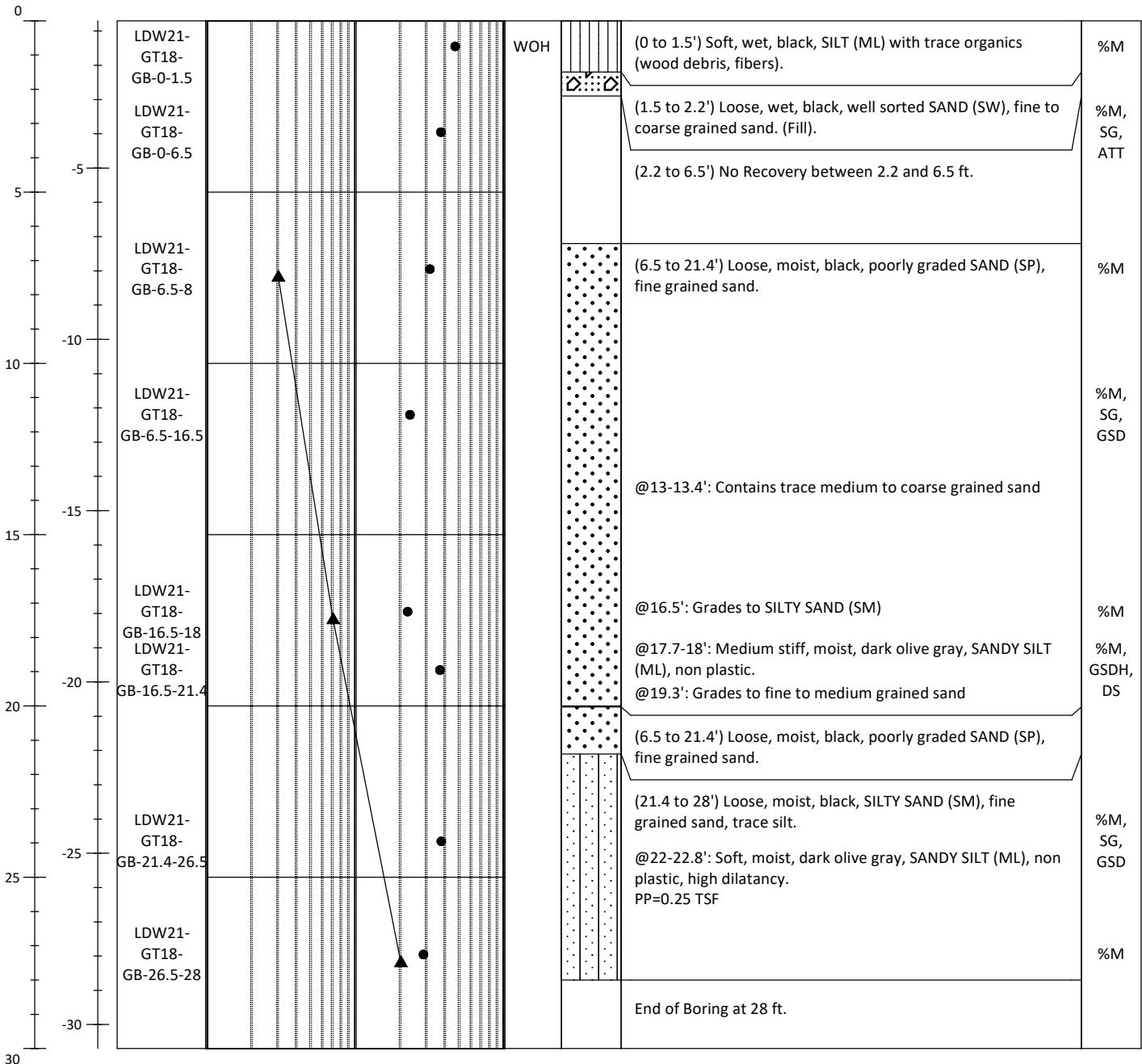
# [DRAFT] Soil Boring Log

## LDW21-GT18-GB

Sheet 1 of 1

Project #: <b>180067-02.03</b>	Project: <b>LDW Upper Reach Phase 2 Investigation</b>	Method: <b>Rotary Sonic</b>
Location: <b>Seattle, WA</b>	N/LAT: <b>194509.577</b> E/LONG: <b>1276175.936</b>	Total Depth (ft): <b>28</b>
Client: <b>Lower Duwamish Waterway Group</b>	Horiz. Datum: <b>Washington State Plane Coordinate North North American Datum of 1983, U.S. Feet</b>	Observed Depth to Mudline (ft): <b>9.5</b>
Collection Date: <b>07.13.21</b>		Mudline Elevation (ft): <b>-0.7</b>
Contractor: <b>Holocene Drilling, Inc</b>	Vert. Datum: <b>Mean Lower Low Water (MLLW)</b>	Hammer: <b>140-lb, 30-in drop, Auto</b>
Logged By: <b>Casey Janisch</b>	Sampler(s): <b>Split Spoon &amp; Shelby Tube Sampler</b>	Hammer Efficiency (%): <b>99</b>

Depth (ft)	Elevation (ft)	Sample ID	Uncorrected Standard Penetration Resistance (blows per foot) and Moisture Content (%)						Other	Lithology	Soil Description Samples and descriptions are in recovered depths. Classification scheme: USCS	Lab Test
			1	2	5	10	20	50				



- ▲ SPT N-Value
- Moisture Content (%)

**Notes:**  
 %M=Percent Moisture Content, SG=Specific Gravity, ATT=Atterberg Limits, GSD=Grainsize Distribution, GSDH=Grainsize Distribution+Hydrometer, 1-D: One-dimensional Consolidation, CU=Unconsolidated Comp. Mudline elevations determined from leadline measurements and Site tide gage levels

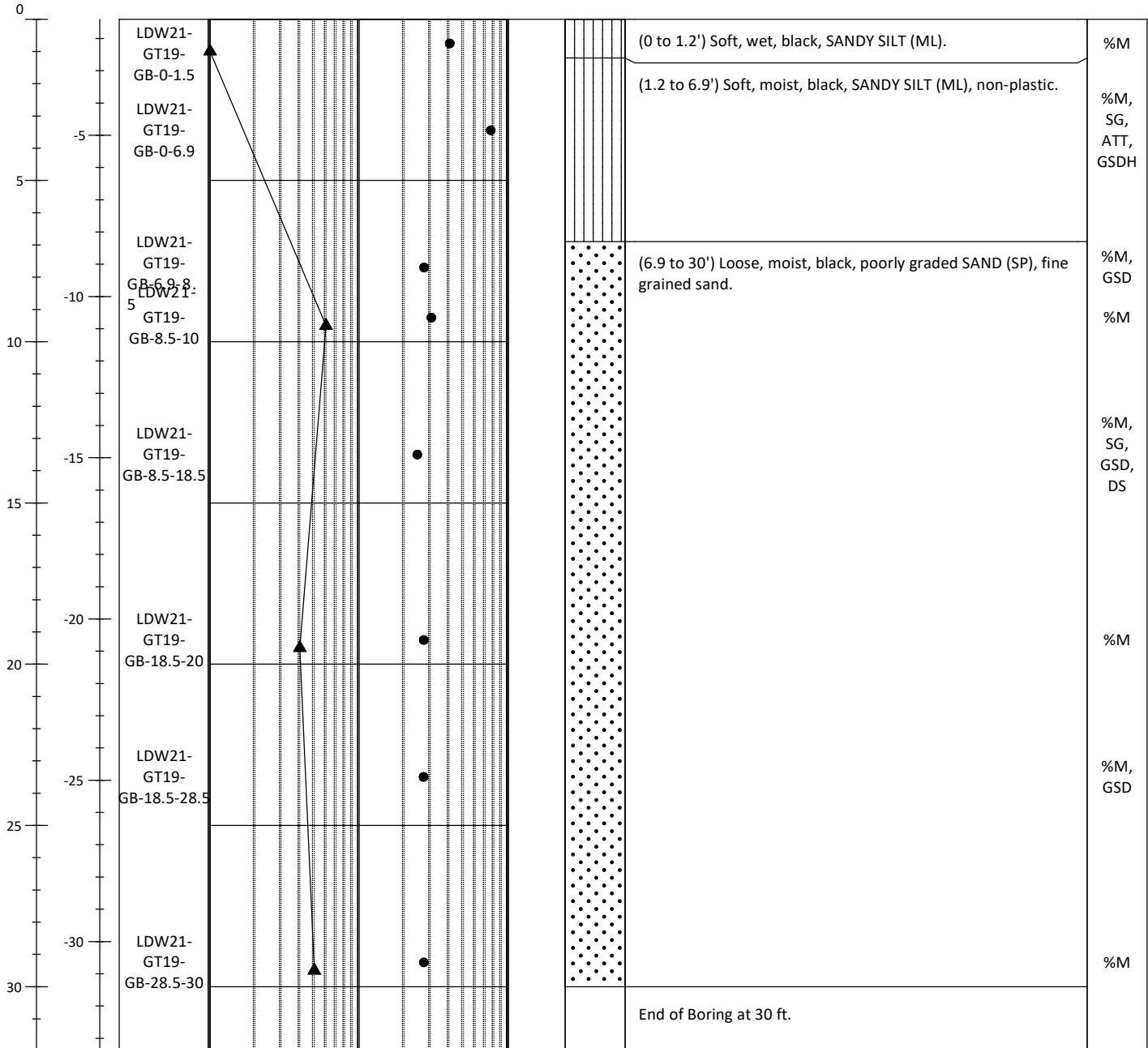
# [DRAFT] Soil Boring Log

## LDW21-GT19-GB

Sheet 1 of 1

Project #: <b>180067-02.03</b>	Project: <b>LDW Upper Reach Phase 2 Investigation</b>	Method: <b>Rotary Sonic</b>
Location: <b>Seattle, WA</b>	N/LAT: <b>194619.686</b> E/LONG: <b>1275815.459</b>	Total Depth (ft): <b>30</b>
Client: <b>Lower Duwamish Waterway Group</b>	Horiz. Datum: <b>Washington State Plane Coordinate North North American Datum of 1983, U.S. Feet</b>	Observed Depth to Mudline (ft): <b>7.5</b>
Collection Date: <b>07.13.21</b>		Mudline Elevation (ft): <b>-1.4</b>
Contractor: <b>Holocene Drilling, Inc</b>	Vert. Datum: <b>Mean Lower Low Water (MLLW)</b>	Hammer: <b>140-lb, 30-in drop, Auto</b>
Logged By: <b>Casey Janisch</b>	Sampler(s): <b>Split Spoon &amp; Shelby Tube Sampler</b>	Hammer Efficiency (%): <b>99</b>

Depth (ft)	Elevation (ft)	Sample ID	Uncorrected Standard Penetration Resistance (blows per foot) and Moisture Content (%)						Other	Lithology	Soil Description Samples and descriptions are in recovered depths. Classification scheme: USCS	Lab Test
			1	2	5	10	20	50				



- ▲ SPT N-Value
- Moisture Content (%)

**Notes:**  
 %M=Percent Moisture Content, SG=Specific Gravity, ATT=Atterberg Limits, GSD=Grainsize Distribution, GSDH=Grainsize Distribution+Hydrometer, 1-D: One-dimensional Consolidation, CU=Unconsolidated Comp  
 Mudline elevations determined from leadline measurements and Site tide gage levels

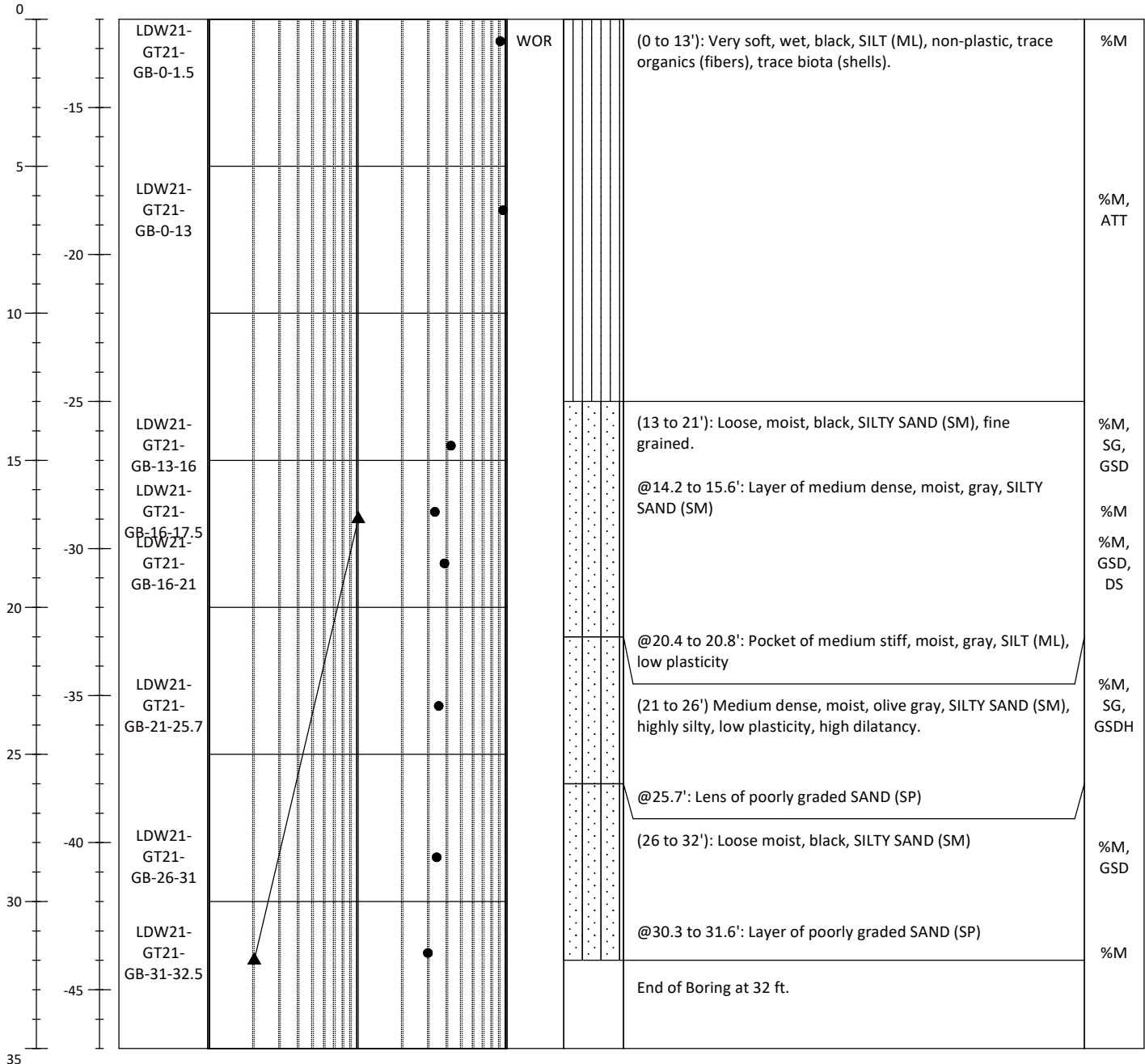
# [DRAFT] Soil Boring Log

## LDW21-GT21-GB

Sheet 1 of 1

Project #: <b>180067-02.03</b>	Project: <b>LDW Upper Reach Phase 2 Investigation</b>	Method: <b>Rotary Sonic</b>
Location: <b>Seattle, WA</b>	N/LAT: <b>194223.416</b> E/LONG: <b>1276127.19</b>	Total Depth (ft): <b>32.5</b>
Client: <b>Lower Duwamish Waterway Group</b>	Horiz. Datum: <b>Washington State Plane Coordinate North North American Datum of 1983, U.S. Feet</b>	Observed Depth to Mudline (ft): <b>11.2</b>
Collection Date: <b>07.08.21</b>		Mudline Elevation (ft): <b>-12.0</b>
Contractor: <b>Holocene Drilling, Inc</b>	Vert. Datum: <b>Mean Lower Low Water (MLLW)</b>	Hammer: <b>140-lb, 30-in drop, Auto</b>
Logged By: <b>Casey Janisch</b>	Sampler(s): <b>Split Spoon &amp; Shelby Tube Sampler</b>	Hammer Efficiency (%): <b>99</b>

Depth (ft)	Elevation (ft)	Sample ID	Uncorrected Standard Penetration Resistance (blows per foot) and Moisture Content (%)						Other	Lithology	Soil Description Samples and descriptions are in recovered depths. Classification scheme: USCS	Lab Test
			1	2	5	10	20	50				



- ▲ SPT N-Value
- Moisture Content (%)

**Notes:**  
 %M=Percent Moisture Content, SG=Specific Gravity, ATT=Atterberg Limits, GSD=Grainsize Distribution, GSDH=Grainsize Distribution+Hydrometer, 1-D: One-dimensional Consolidation, CU=Unconsolidated Comp. Mudline elevations determined from leadline measurements and Site tide gage levels

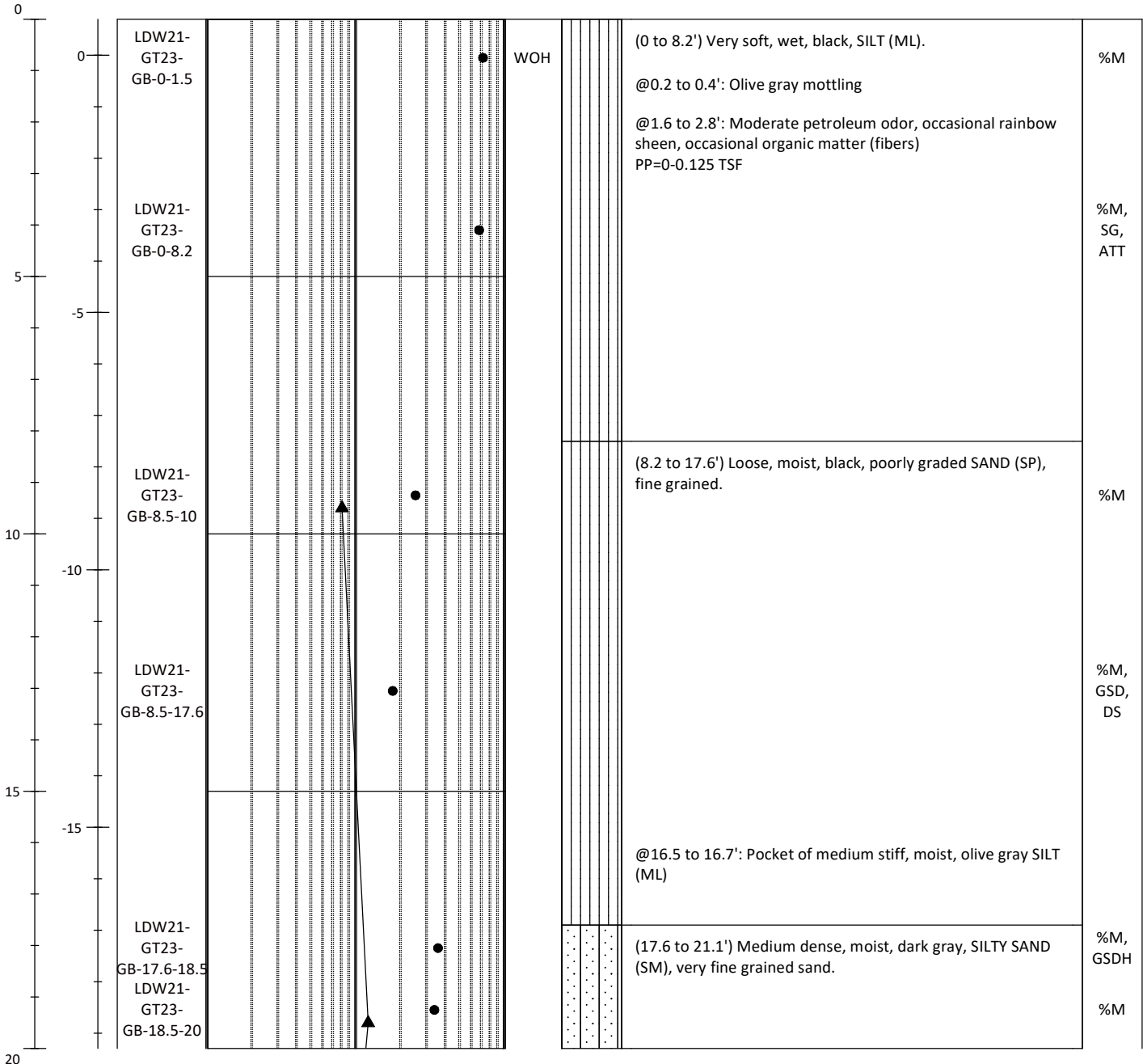
# [DRAFT] Soil Boring Log

## LDW21-GT23-GB

Sheet 1 of 2

Project #: <b>180067-02.03</b>	Project: <b>LDW Upper Reach Phase 2 Investigation</b>	Method: <b>Rotary Sonic</b>
Location: <b>Seattle, WA</b>	N/LAT: <b>194225.679</b> E/LONG: <b>1276262.681</b>	Total Depth (ft): <b>32</b>
Client: <b>Lower Duwamish Waterway Group</b>	Horiz. Datum: <b>Washington State Plane Coordinate North North American Datum of 1983, U.S. Feet</b>	Observed Depth to Mudline (ft): <b>7.5</b>
Collection Date: <b>07.16.21</b>		Mudline Elevation (ft): <b>0.7</b>
Contractor: <b>Holocene Drilling, Inc</b>	Vert. Datum: <b>Mean Lower Low Water (MLLW)</b>	Hammer: <b>140-lb, 30-in drop, Auto</b>
Logged By: <b>Casey Janisch</b>	Sampler(s): <b>Split Spoon &amp; Shelby Tube Sampler</b>	Hammer Efficiency (%): <b>99</b>

Depth (ft)	Elevation (ft)	Sample ID	Uncorrected Standard Penetration Resistance (blows per foot) and Moisture Content (%)						Other	Lithology	Soil Description Samples and descriptions are in recovered depths. Classification scheme: USCS	Lab Test
			1	2	5	10	20	50				



- ▲ SPT N-Value
- Moisture Content (%)

**Notes:**  
 %M=Percent Moisture Content, SG=Specific Gravity, ATT=Atterberg Limits, GSD=Grainsize Distribution, GSDH=Grainsize Distribution+Hydrometer, 1-D: One-dimensional Consolidation, CU=Unconsolidated Comp. Mudline elevations determined from leadline measurements and Site tide gage levels

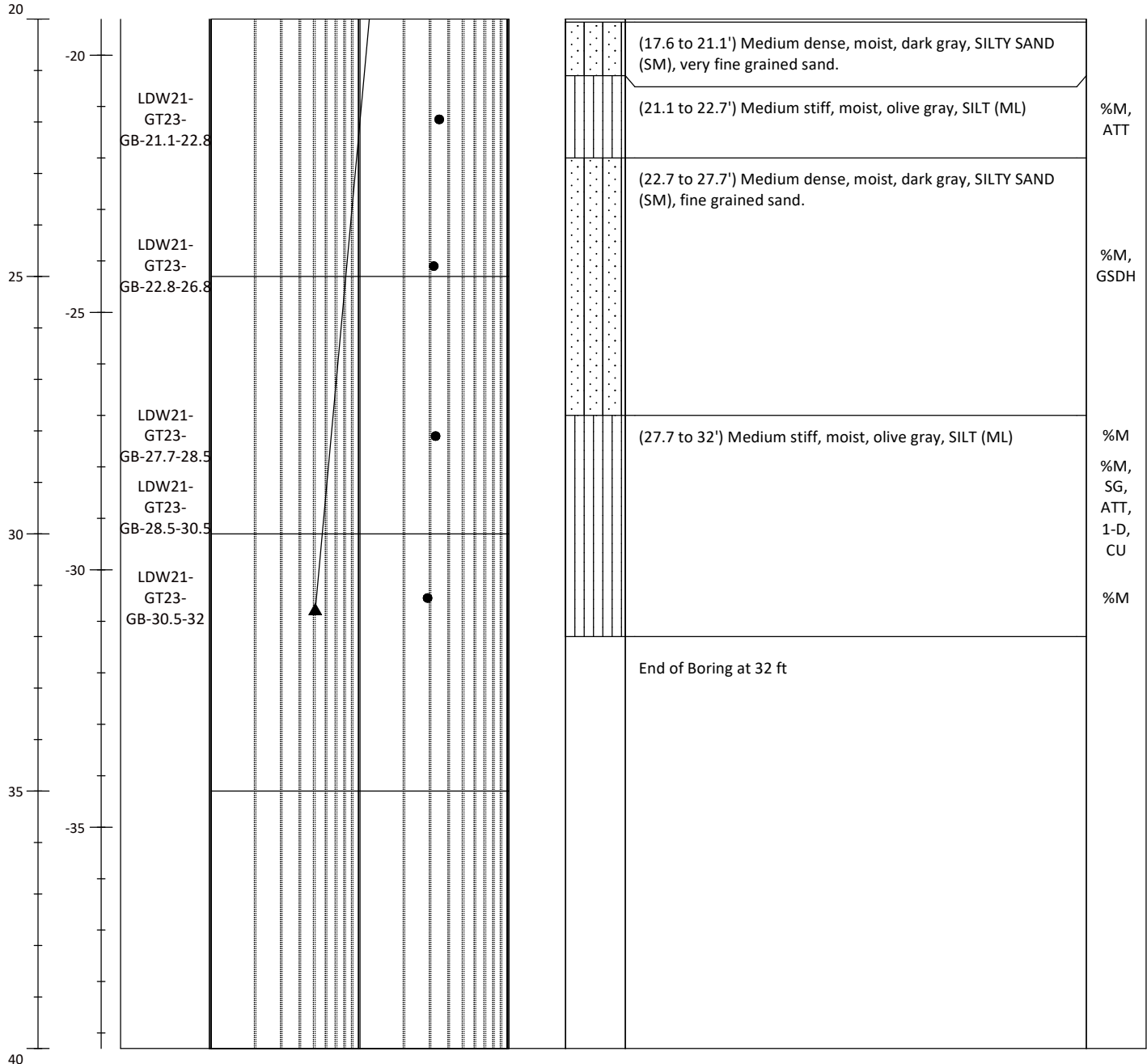
# [DRAFT] Soil Boring Log

## LDW21-GT23-GB

Sheet 2 of 2

Project #: <b>180067-02.03</b>	Project: <b>LDW Upper Reach Phase 2 Investigation</b>	Method: <b>Rotary Sonic</b>
Location: <b>Seattle, WA</b>	N/LAT: <b>194225.679</b> E/LONG: <b>1276262.681</b>	Total Depth (ft): <b>32</b>
Client: <b>Lower Duwamish Waterway Group</b>	Horiz. Datum: <b>Washington State Plane Coordinate North North American Datum of 1983, U.S. Feet</b>	Observed Depth to Mudline (ft): <b>7.5</b>
Collection Date: <b>07.16.21</b>		Mudline Elevation (ft): <b>0.7</b>
Contractor: <b>Holocene Drilling, Inc</b>	Vert. Datum: <b>Mean Lower Low Water (MLLW)</b>	Hammer: <b>140-lb, 30-in drop, Auto</b>
Logged By: <b>Casey Janisch</b>	Sampler(s): <b>Split Spoon &amp; Shelby Tube Sampler</b>	Hammer Efficiency (%): <b>99</b>

Depth (ft)	Elevation (ft)	Sample ID	Uncorrected Standard Penetration Resistance (blows per foot) and Moisture Content (%)						Other	Lithology	Soil Description Samples and descriptions are in recovered depths. Classification scheme: USCS	Lab Test
			1	2	5	10	20	50				



- ▲ SPT N-Value
- Moisture Content (%)

**Notes:**  
 %M=Percent Moisture Content, SG=Specific Gravity, ATT=Atterberg Limits, GSD=Grainsize Distribution, GSDH=Grainsize Distribution+Hydrometer, 1-D: One-dimensional Consolidation, CU=Unconsolidated Comp. Mudline elevations determined from leadline measurements and Site tide gage levels

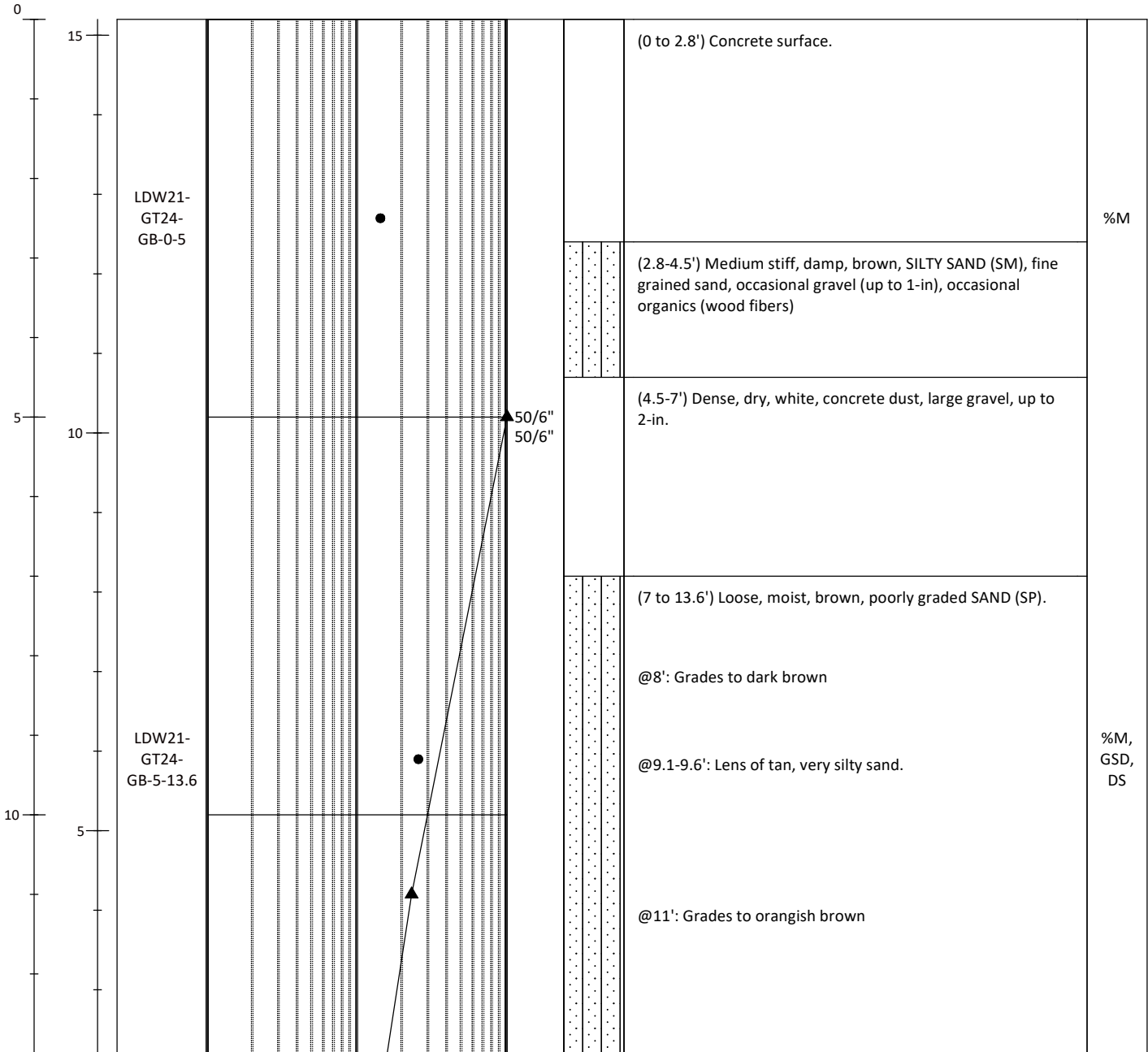
# [DRAFT] Soil Boring Log

## LDW21-GT24-GB

Sheet 1 of 5

Project #: <b>180067-02.03</b>	Project: <b>LDW Upper Reach Phase 2 Investigation</b>	Method: <b>Rotary Sonic</b>
Location: <b>Seattle, WA</b>	N/LAT: <b>193910.921</b> E/LONG: <b>1276412.765</b>	Total Depth (ft): <b>61.5</b>
Client: <b>Lower Duwamish Waterway Group</b>	Horiz. Datum: <b>Washington State Plane Coordinate North North American Datum of 1983, U.S. Feet</b>	Observed Depth to Mudline ( <del>NA</del> ):
Collection Date: <b>7.26.21</b>		Surface Elevation (ft): <b>15.2</b>
Contractor: <b>Holocene Drilling, Inc</b>	Vert. Datum: <b>Mean Lower Low Water (MLLW)</b>	Hammer: <b>140-lb, 30-in drop, Auto</b>
Logged By: <b>Sam Giannakos</b>	Sampler(s): <b>Split Spoon &amp; Shelby Tube Sampler</b>	Hammer Efficiency (%): <b>99</b>

Depth (ft)	Elevation (ft)	Sample ID	Uncorrected Standard Penetration Resistance (blows per foot) and Moisture Content (%)						Other	Lithology	Soil Description Samples and descriptions are in recovered depths. Classification scheme: USCS	Lab Test
			1	2	5	10	20	50				



- ▲ SPT N-Value
- Moisture Content (%)

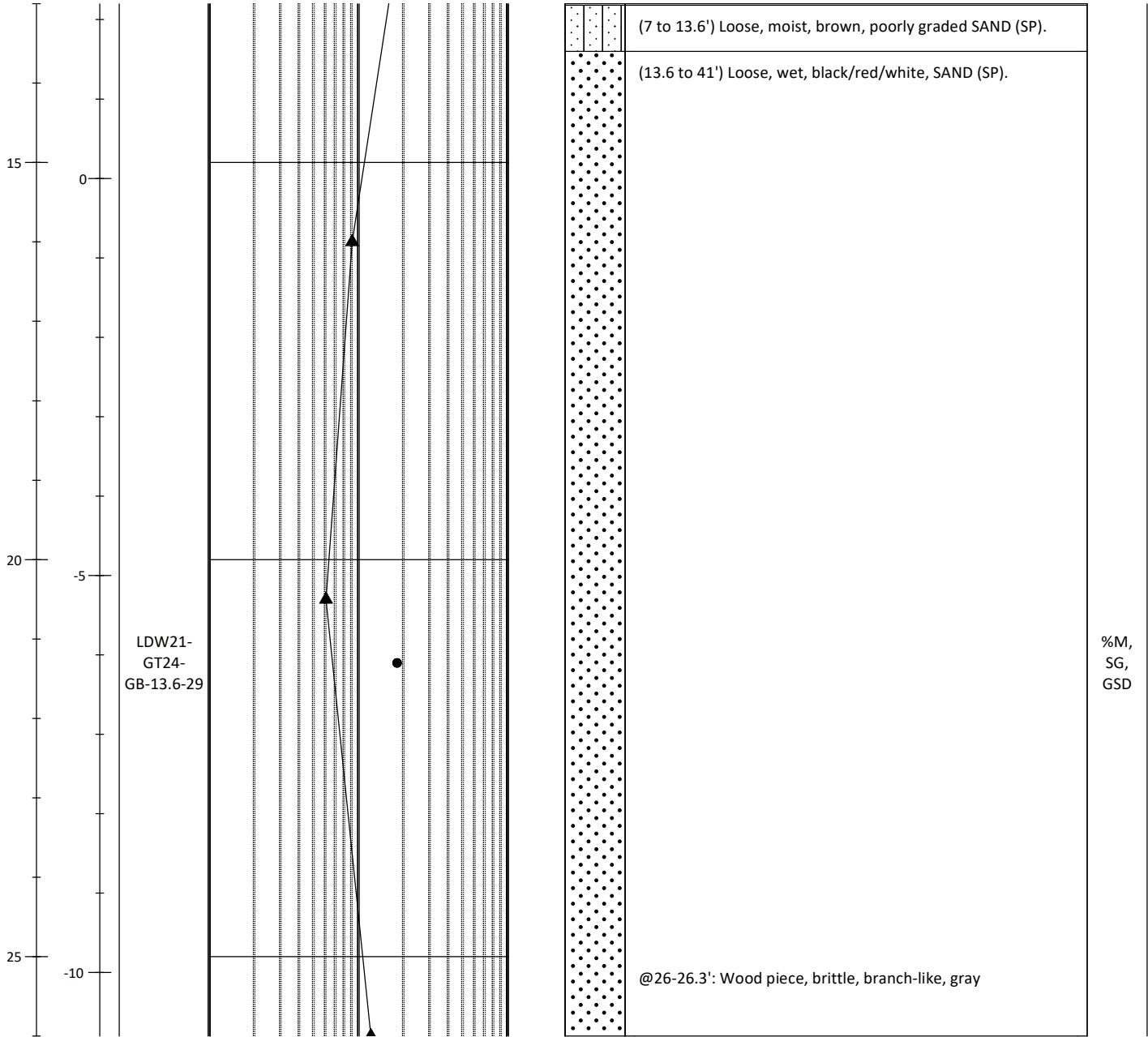
**Notes:**  
 %M=Percent Moisture Content, SG=Specific Gravity, ATT=Atterberg Limits, GSD=Grainsize Distribution, GSDH=Grainsize Distribution+Hydrometer, 1-D: One-dimensional Consolidation, CU=Unconsolidated Comp  
 Elevation estimated using proposed location base map, no depth to mudline reported

# [DRAFT] Soil Boring Log

## LDW21-GT24-GB

Project #: <b>180067-02.03</b>	Project: <b>LDW Upper Reach Phase 2 Investigation</b>	Method: <b>Rotary Sonic</b>
Location: <b>Seattle, WA</b>	N/LAT: <b>193910.921</b> E/LONG: <b>1276412.765</b>	Total Depth (ft): <b>61.5</b>
Client: <b>Lower Duwamish Waterway Group</b>	Horiz. Datum: <b>Washington State Plane Coordinate North North American Datum of 1983, U.S. Feet</b>	Observed Depth to Mudline ( <del>NA</del> ):
Collection Date: <b>7.26.21</b>		Surface Elevation (ft): <b>15.2</b>
Contractor: <b>Holocene Drilling, Inc</b>	Vert. Datum: <b>Mean Lower Low Water (MLLW)</b>	Hammer: <b>140-lb, 30-in drop, Auto</b>
Logged By: <b>Sam Giannakos</b>	Sampler(s): <b>Split Spoon &amp; Shelby Tube Sampler</b>	Hammer Efficiency (%): <b>99</b>

Depth (ft)	Elevation (ft)	Sample ID	Uncorrected Standard Penetration Resistance (blows per foot) and Moisture Content (%)						Other	Lithology	Soil Description Samples and descriptions are in recovered depths. Classification scheme: USCS	Lab Test
			1	2	5	10	20	100				



<p>1201 Third Avenue Suite 2600 Seattle, WA 98101</p>	<ul style="list-style-type: none"> <li>▲ SPT N-Value</li> <li>● Moisture Content (%)</li> </ul>	<p><b>Notes:</b>                  %M=Percent Moisture Content, SG=Specific Gravity, ATT=Atterberg Limits, GSD=Grainsize Distribution, GSDH=Grainsize Distribution+Hydrometer, 1-D: One-dimensional Consolidation, CU=Unconsolidated Comp                  Elevation estimated using proposed location base map, no depth to mudline reported</p>
---	---	--

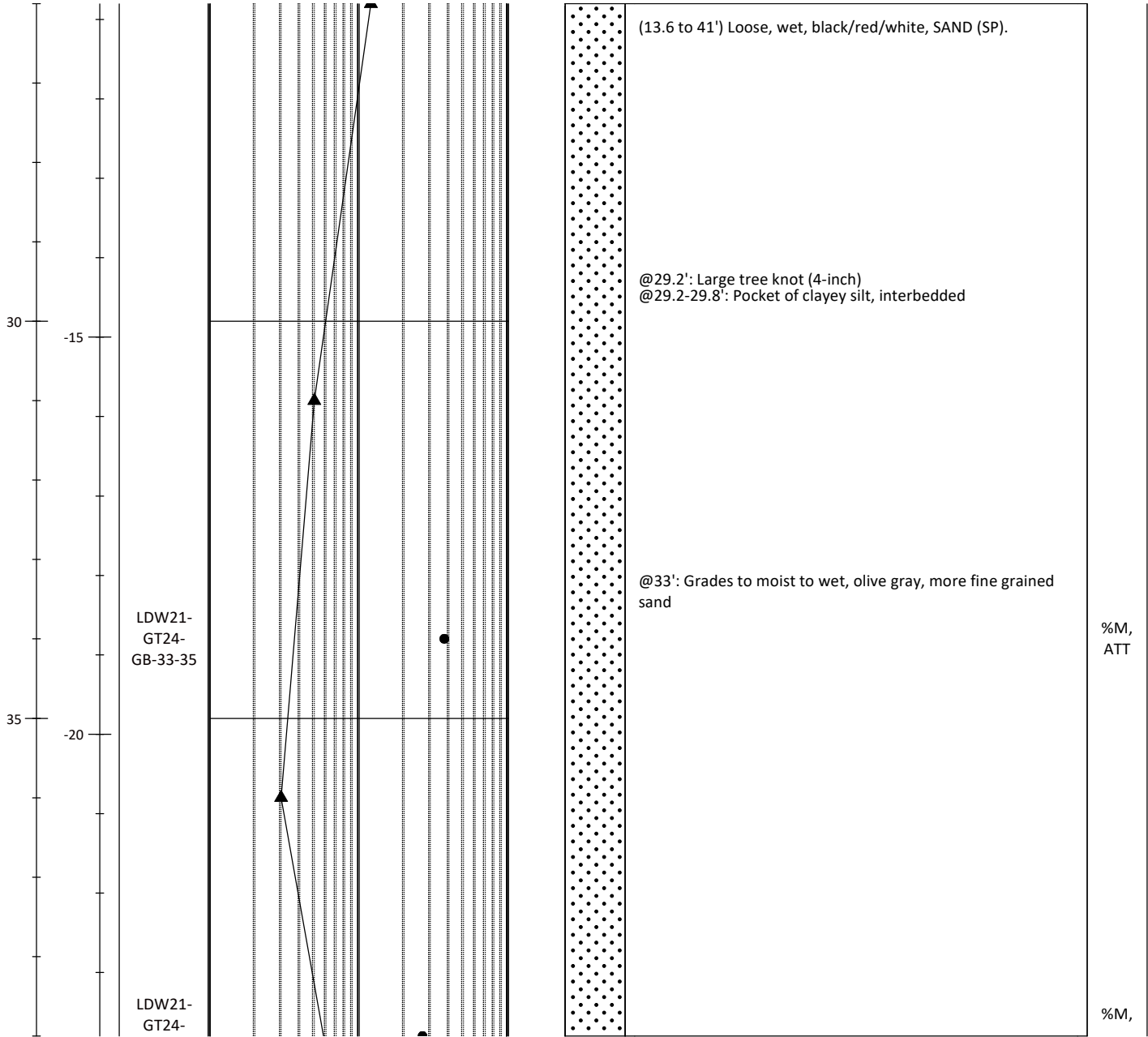
# [DRAFT] Soil Boring Log

## LDW21-GT24-GB

Sheet 3 of 5

Project #: <b>180067-02.03</b>	Project: <b>LDW Upper Reach Phase 2 Investigation</b>	Method: <b>Rotary Sonic</b>
Location: <b>Seattle, WA</b>	N/LAT: <b>193910.921</b> E/LONG: <b>1276412.765</b>	Total Depth (ft): <b>61.5</b>
Client: <b>Lower Duwamish Waterway Group</b>	Horiz. Datum: <b>Washington State Plane Coordinate North North American Datum of 1983, U.S. Feet</b>	Observed Depth to Mudline ( <del>NA</del> ):
Collection Date: <b>7.26.21</b>		Surface Elevation (ft): <b>15.2</b>
Contractor: <b>Holocene Drilling, Inc</b>	Vert. Datum: <b>Mean Lower Low Water (MLLW)</b>	Hammer: <b>140-lb, 30-in drop, Auto</b>
Logged By: <b>Sam Giannakos</b>	Sampler(s): <b>Split Spoon &amp; Shelby Tube Sampler</b>	Hammer Efficiency (%): <b>99</b>

Depth (ft)	Elevation (ft)	Sample ID	Uncorrected Standard Penetration Resistance (blows per foot) and Moisture Content (%)						Other	Lithology	Soil Description Samples and descriptions are in recovered depths. Classification scheme: USCS	Lab Test
			1	2	5	10	20	50				



- ▲ SPT N-Value
- Moisture Content (%)

**Notes:**  
 %M=Percent Moisture Content, SG=Specific Gravity, ATT=Atterberg Limits, GSD=Grainsize Distribution, GSDH=Grainsize Distribution+Hydrometer, 1-D: One-dimensional Consolidation, CU=Unconsolidated Comp  
 Elevation estimated using proposed location base map, no depth to mudline reported



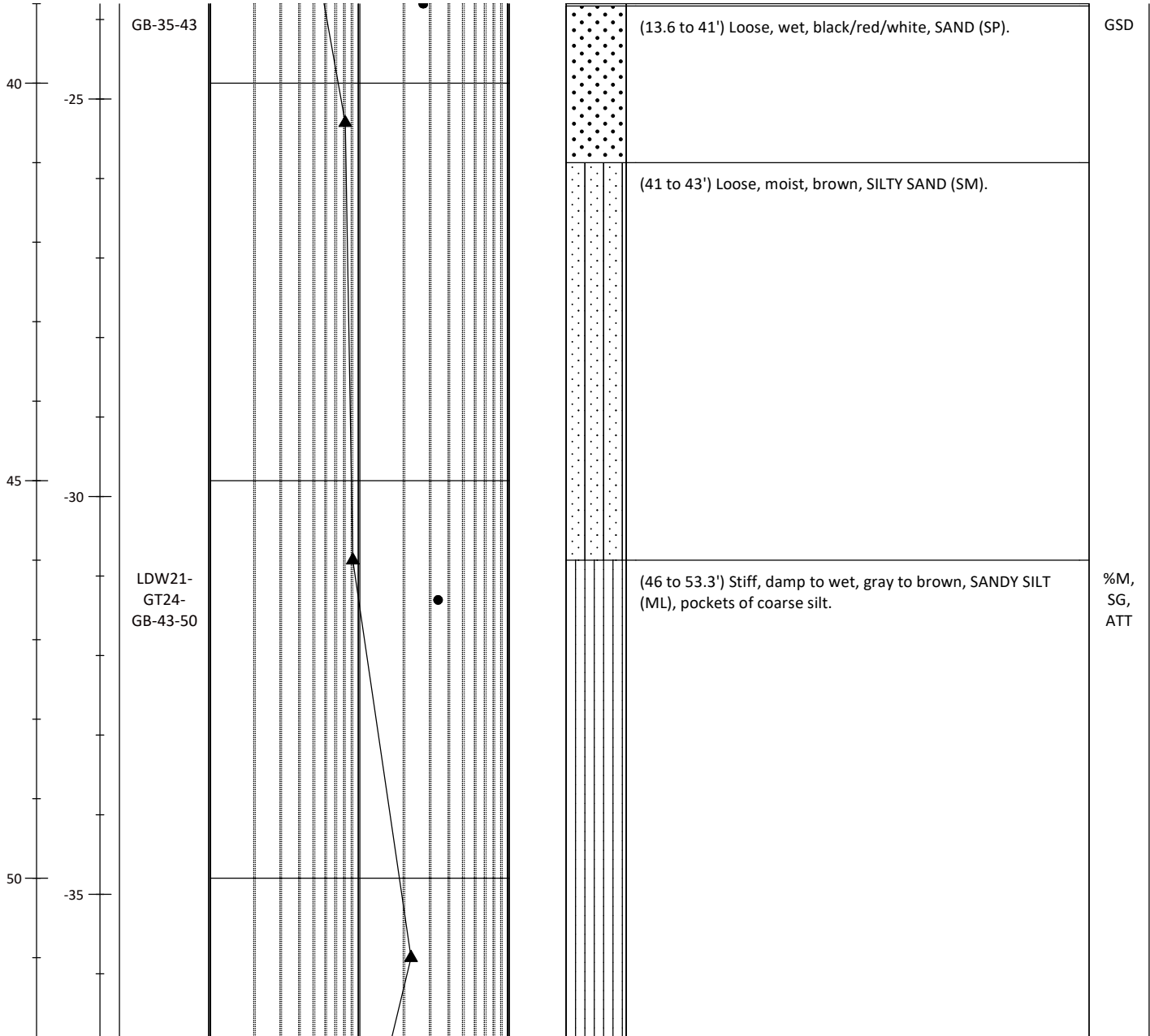
# [DRAFT] Soil Boring Log

## LDW21-GT24-GB

Sheet 4 of 5

Project #: <b>180067-02.03</b>	Project: <b>LDW Upper Reach Phase 2 Investigation</b>	Method: <b>Rotary Sonic</b>
Location: <b>Seattle, WA</b>	N/LAT: <b>193910.921</b> E/LONG: <b>1276412.765</b>	Total Depth (ft): <b>61.5</b>
Client: <b>Lower Duwamish Waterway Group</b>	Horiz. Datum: <b>Washington State Plane Coordinate North North American Datum of 1983, U.S. Feet</b>	Observed Depth to Mudline ( <del>NA</del> ):
Collection Date: <b>7.26.21</b>		Surface Elevation (ft): <b>15.2</b>
Contractor: <b>Holocene Drilling, Inc</b>	Vert. Datum: <b>Mean Lower Low Water (MLLW)</b>	Hammer: <b>140-lb, 30-in drop, Auto</b>
Logged By: <b>Sam Giannakos</b>	Sampler(s): <b>Split Spoon &amp; Shelby Tube Sampler</b>	Hammer Efficiency (%): <b>99</b>

Depth (ft)	Elevation (ft)	Sample ID	Uncorrected Standard Penetration Resistance (blows per foot) and Moisture Content (%)						Other	Lithology	Soil Description Samples and descriptions are in recovered depths. Classification scheme: USCS	Lab Test
			1	2	5	10	20	50				



- ▲ SPT N-Value
- Moisture Content (%)

**Notes:**  
 %M=Percent Moisture Content, SG=Specific Gravity, ATT=Atterberg Limits, GSD=Grainsize Distribution, GSDH=Grainsize Distribution+Hydrometer, 1-D: One-dimensional Consolidation, CU=Unconsolidated Comp  
 Elevation estimated using proposed location base map, no depth to mudline reported

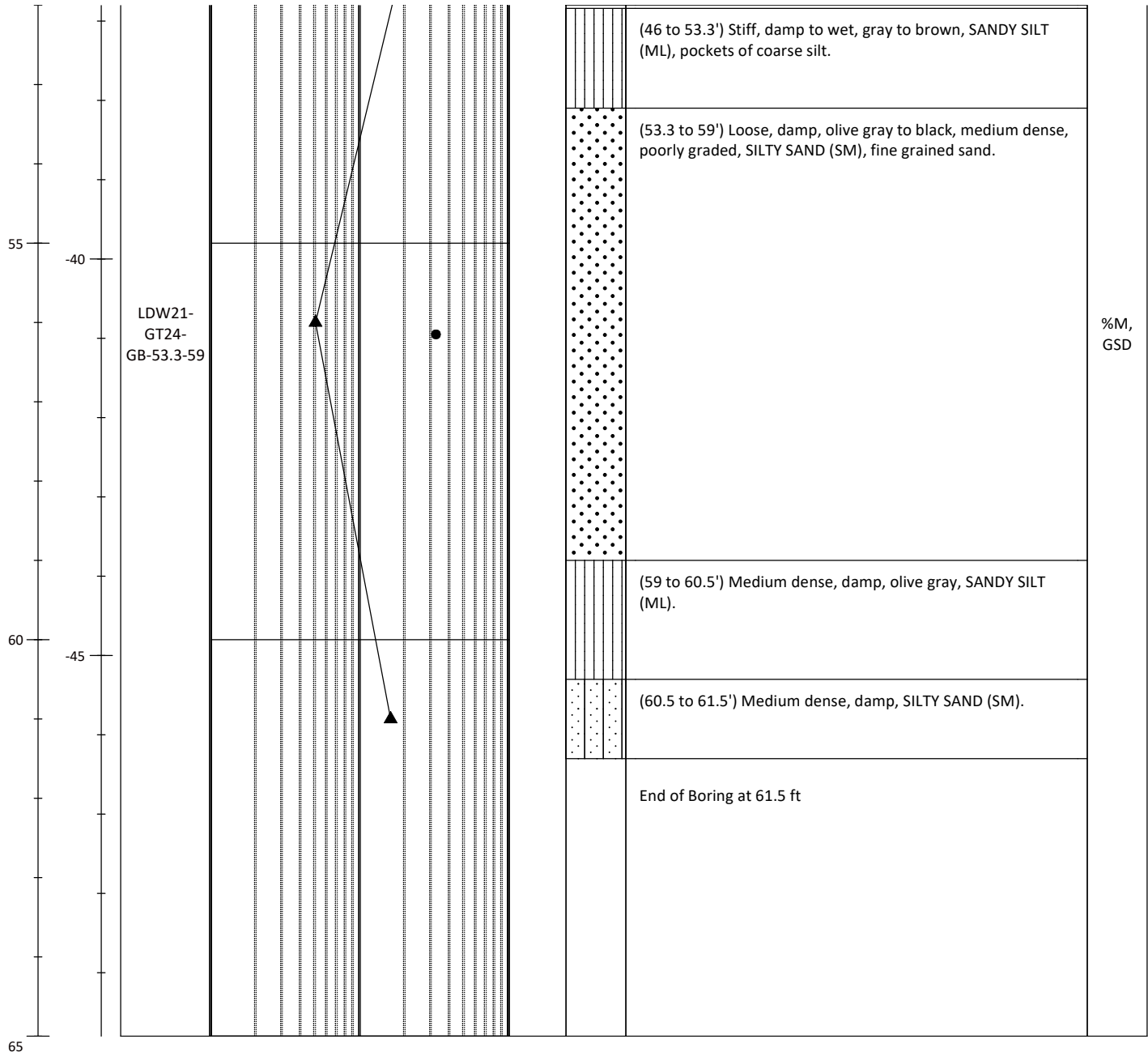
# [DRAFT] Soil Boring Log

## LDW21-GT24-GB

Sheet 5 of 5

Project #: <b>180067-02.03</b>	Project: <b>LDW Upper Reach Phase 2 Investigation</b>	Method: <b>Rotary Sonic</b>
Location: <b>Seattle, WA</b>	N/LAT: <b>193910.921</b> E/LONG: <b>1276412.765</b>	Total Depth (ft): <b>61.5</b>
Client: <b>Lower Duwamish Waterway Group</b>	Horiz. Datum: <b>Washington State Plane Coordinate North North American Datum of 1983, U.S. Feet</b>	Observed Depth to Mudline ( <del>NA</del> ):
Collection Date: <b>7.26.21</b>		Surface Elevation (ft): <b>15.2</b>
Contractor: <b>Holocene Drilling, Inc</b>	Vert. Datum: <b>Mean Lower Low Water (MLLW)</b>	Hammer: <b>140-lb, 30-in drop, Auto</b>
Logged By: <b>Sam Giannakos</b>	Sampler(s): <b>Split Spoon &amp; Shelby Tube Sampler</b>	Hammer Efficiency (%): <b>99</b>

Depth (ft)	Elevation (ft)	Sample ID	Uncorrected Standard Penetration Resistance (blows per foot) and Moisture Content (%)						Other	Lithology	Soil Description Samples and descriptions are in recovered depths. Classification scheme: USCS	Lab Test
			1	2	5	10	20	50				



- ▲ SPT N-Value
- Moisture Content (%)

**Notes:**  
 %M=Percent Moisture Content, SG=Specific Gravity, ATT=Atterberg Limits, GSD=Grainsize Distribution, GSDH=Grainsize Distribution+Hydrometer, 1-D: One-dimensional Consolidation, CU=Unconsolidated Comp  
 Elevation estimated using proposed location base map, no depth to mudline reported

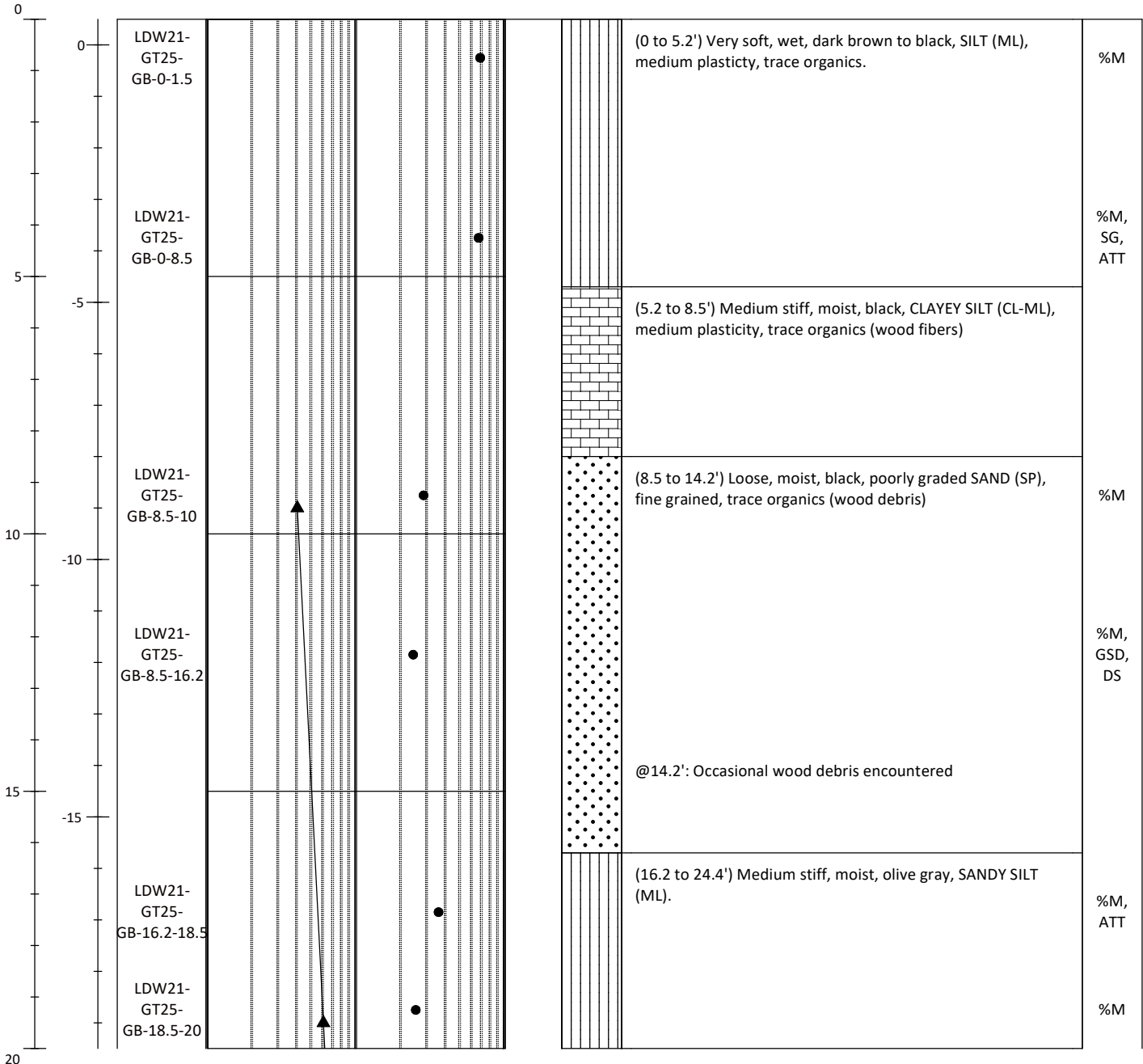
# [DRAFT] Soil Boring Log

## LDW21-GT25-GB

Sheet 1 of 2

Project #: <b>180067-02.03</b>	Project: <b>LDW Upper Reach Phase 2 Investigation</b>	Method: <b>Rotary Sonic</b>
Location: <b>Seattle, WA</b>	N/LAT: <b>193902.768</b> E/LONG: <b>1276326.832</b>	Total Depth (ft): <b>30</b>
Client: <b>Lower Duwamish Waterway Group</b>	Horiz. Datum: <b>Washington State Plane Coordinate North North American Datum of 1983, U.S. Feet</b>	Observed Depth to Mudline (ft): <b>7.5</b>
Collection Date: <b>07.15.21</b>		Mudline Elevation (ft): <b>0.5</b>
Contractor: <b>Holocene Drilling, Inc</b>	Vert. Datum: <b>Mean Lower Low Water (MLLW)</b>	Hammer: <b>140-lb, 30-in drop, Auto</b>
Logged By: <b>Casey Janisch</b>	Sampler(s): <b>Split Spoon &amp; Shelby Tube Sampler</b>	Hammer Efficiency (%): <b>99</b>

Depth (ft)	Elevation (ft)	Sample ID	Uncorrected Standard Penetration Resistance (blows per foot) and Moisture Content (%)						Other	Lithology	Soil Description Samples and descriptions are in recovered depths. Classification scheme: USCS	Lab Test
			1	2	5	10	20	50				



<p>1201 Third Avenue Suite 2600 Seattle, WA 98101</p>	<ul style="list-style-type: none"> <li>▲ SPT N-Value</li> <li>● Moisture Content (%)</li> </ul>	<p><b>Notes:</b>                  %M=Percent Moisture Content,SG=Specific Gravity,ATT=Atterberg Limits,GSD=Grainsize Distribution,                  GSDH=Grainsize Distribution+Hydrometer,1-D: One-dimensional Consolidation,CU=Unconsolidated Comp.                  Mudline elevations determined from leadline measurements and Site tide gage levels</p>
---	---	---

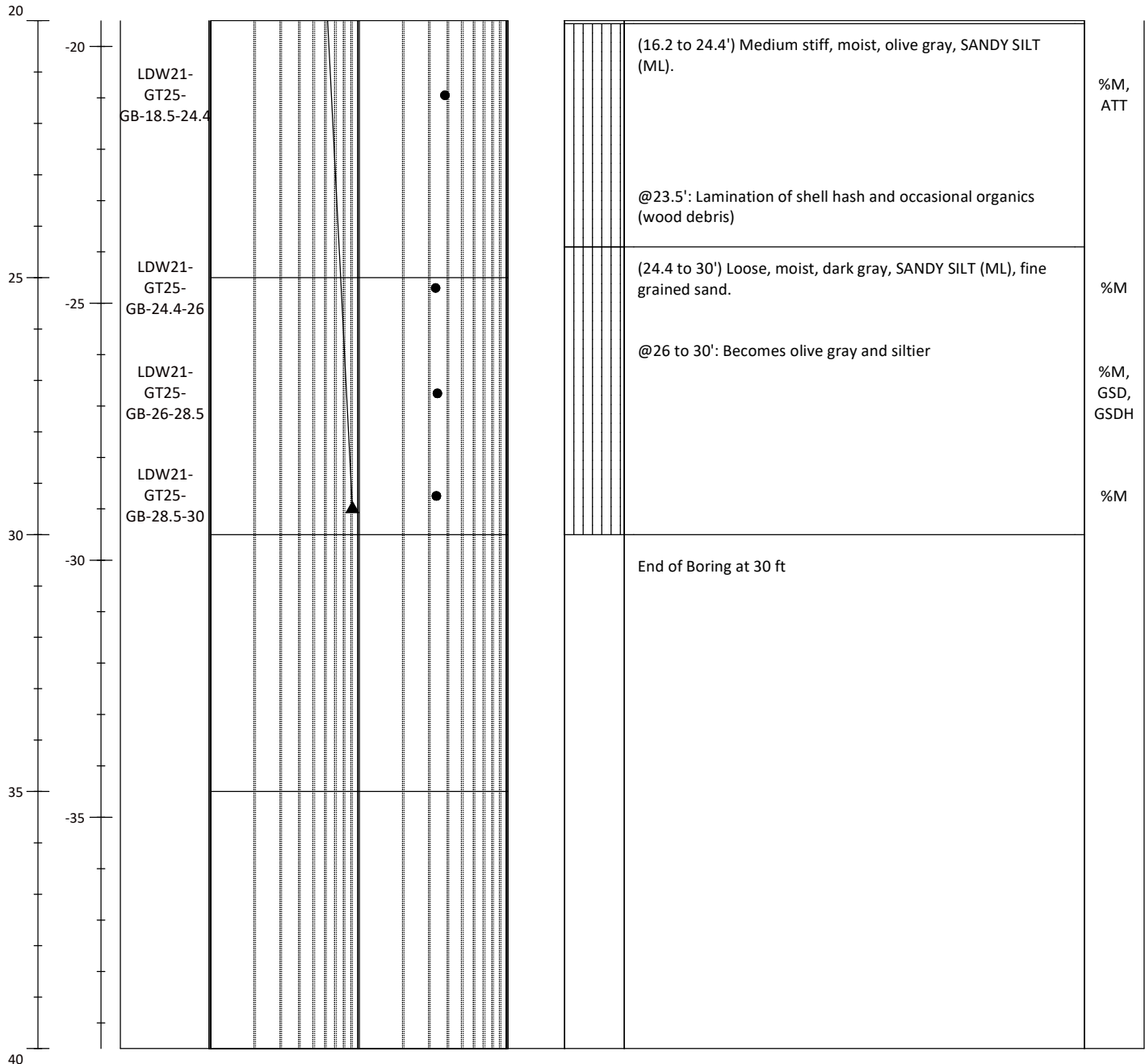
# [DRAFT] Soil Boring Log

## LDW21-GT25-GB

Sheet 2 of 2

Project #: <b>180067-02.03</b>	Project: <b>LDW Upper Reach Phase 2 Investigation</b>	Method: <b>Rotary Sonic</b>
Location: <b>Seattle, WA</b>	N/LAT: <b>193902.768</b> E/LONG: <b>1276326.832</b>	Total Depth (ft): <b>30</b>
Client: <b>Lower Duwamish Waterway Group</b>	Horiz. Datum: <b>Washington State Plane Coordinate North North American Datum of 1983, U.S. Feet</b>	Observed Depth to Mudline (ft): <b>7.5</b>
Collection Date: <b>07.15.21</b>		Mudline Elevation (ft): <b>0.5</b>
Contractor: <b>Holocene Drilling, Inc</b>	Vert. Datum: <b>Mean Lower Low Water (MLLW)</b>	Hammer: <b>140-lb, 30-in drop, Auto</b>
Logged By: <b>Casey Janisch</b>	Sampler(s): <b>Split Spoon &amp; Shelby Tube Sampler</b>	Hammer Efficiency (%): <b>99</b>

Depth (ft)	Elevation (ft)	Sample ID	Uncorrected Standard Penetration Resistance (blows per foot) and Moisture Content (%)						Other	Lithology	Soil Description Samples and descriptions are in recovered depths. Classification scheme: USCS	Lab Test
			1	2	5	10	20	50				



- ▲ SPT N-Value
- Moisture Content (%)

**Notes:**  
 %M=Percent Moisture Content, SG=Specific Gravity, ATT=Atterberg Limits, GSD=Grainsize Distribution, GSDH=Grainsize Distribution+Hydrometer, 1-D: One-dimensional Consolidation, CU=Unconsolidated Comp.  
 Mudline elevations determined from leadline measurements and Site tide gage levels

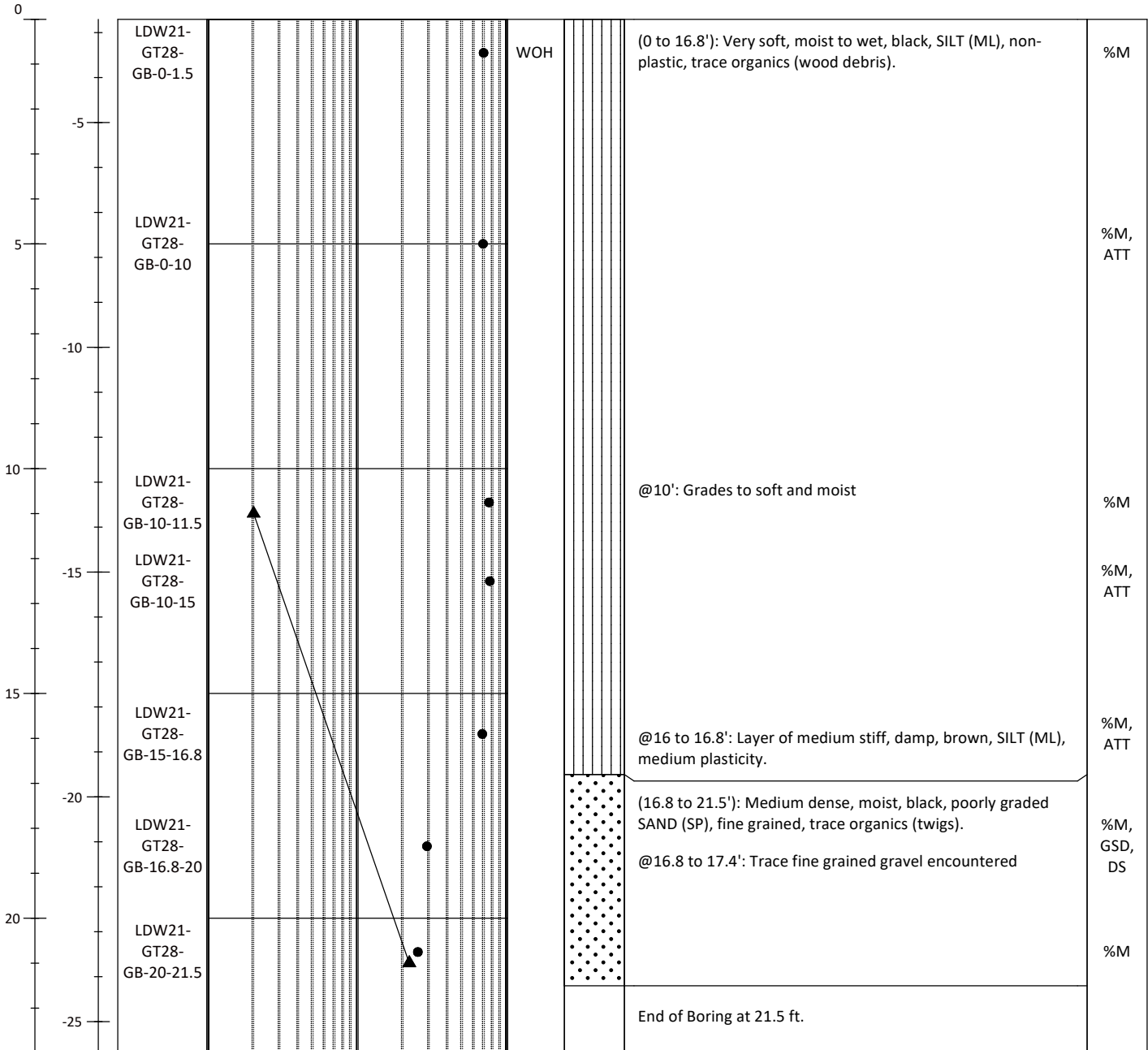
# [DRAFT] Soil Boring Log

## LDW21-GT28-GB

Sheet 1 of 1

Project #: <b>180067-02.03</b>	Project: <b>LDW Upper Reach Phase 2 Investigation</b>	Method: <b>Rotary Sonic</b>
Location: <b>Seattle, WA</b>	N/LAT: <b>193703.693</b> E/LONG: <b>1275982.714</b>	Total Depth (ft): <b>21.5</b>
Client: <b>Lower Duwamish Waterway Group</b>	Horiz. Datum: <b>Washington State Plane Coordinate North North American Datum of 1983, U.S. Feet</b>	Observed Depth to Mudline (ft): <b>12.2</b>
Collection Date: <b>07.07.21</b>		Mudline Elevation (ft): <b>-2.7</b>
Contractor: <b>Holocene Drilling, Inc</b>	Vert. Datum: <b>Mean Lower Low Water (MLLW)</b>	Hammer: <b>140-lb, 30-in drop, Auto</b>
Logged By: <b>Casey Janisch</b>	Sampler(s): <b>Split Spoon &amp; Shelby Tube Sampler</b>	Hammer Efficiency (%): <b>99</b>

Depth (ft)	Elevation (ft)	Sample ID	Uncorrected Standard Penetration Resistance (blows per foot) and Moisture Content (%)						Other	Lithology	Soil Description Samples and descriptions are in recovered depths. Classification scheme: USCS	Lab Test
			1	2	5	10	20	50				



- ▲ SPT N-Value
- Moisture Content (%)

**Notes:**  
 %M=Percent Moisture Content, SG=Specific Gravity, ATT=Atterberg Limits, GSD=Grainsize Distribution, GSDH=Grainsize Distribution+Hydrometer, 1-D: One-dimensional Consolidation, CU=Unconsolidated Comp. Mudline elevations determined from leadline measurements and Site tide gage levels

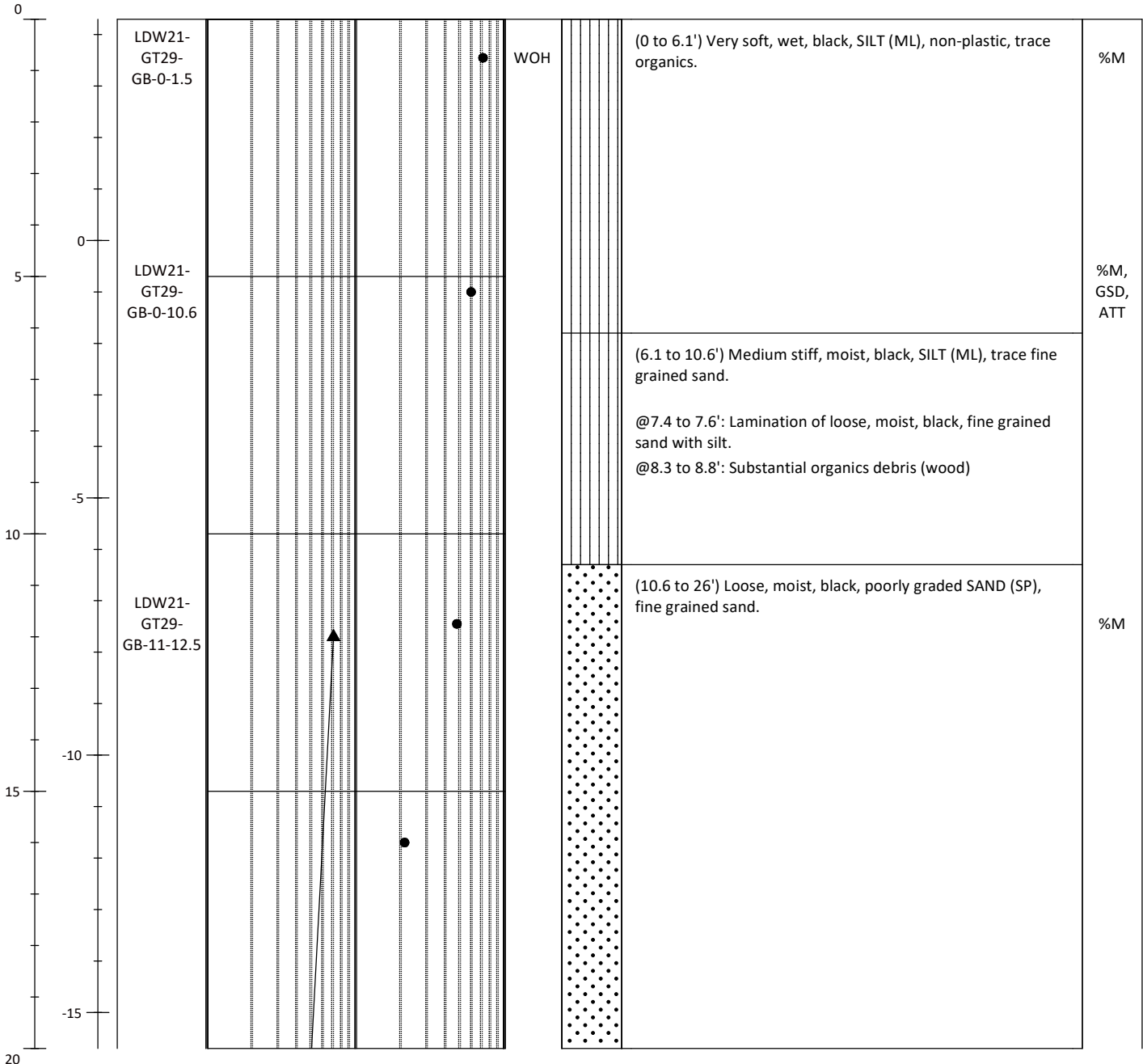
# [DRAFT] Soil Boring Log

## LDW21-GT29-GB

Sheet 1 of 2

Project #: <b>180067-02.03</b>	Project: <b>LDW Upper Reach Phase 2 Investigation</b>	Method: <b>Rotary Sonic</b>
Location: <b>Seattle, WA</b>	N/LAT: <b>193401.625</b> E/LONG: <b>1276568.528</b>	Total Depth (ft): <b>32.5</b>
Client: <b>Lower Duwamish Waterway Group</b>	Horiz. Datum: <b>Washington State Plane Coordinate North North American Datum of 1983, U.S. Feet</b>	Observed Depth to Mudline (ft): <b>5.0</b>
Collection Date: <b>07.14.21</b>		Mudline Elevation (ft): <b>4.3</b>
Contractor: <b>Holocene Drilling, Inc</b>	Vert. Datum: <b>Mean Lower Low Water (MLLW)</b>	Hammer: <b>140-lb, 30-in drop, Auto</b>
Logged By: <b>Casey Janisch</b>	Sampler(s): <b>Split Spoon &amp; Shelby Tube Sampler</b>	Hammer Efficiency (%): <b>99</b>

Depth (ft)	Elevation (ft)	Sample ID	Uncorrected Standard Penetration Resistance (blows per foot) and Moisture Content (%)						Other	Lithology	Soil Description Samples and descriptions are in recovered depths. Classification scheme: USCS	Lab Test
			1	2	5	10	20	50				



<p>1201 Third Avenue Suite 2600 Seattle, WA 98101</p>	<ul style="list-style-type: none"> <li>▲ SPT N-Value</li> <li>● Moisture Content (%)</li> </ul>	<p><b>Notes:</b>                  %M=Percent Moisture Content,SG=Specific Gravity,ATT=Atterberg Limits,GSD=Grainsize Distribution,                  GSDH=Grainsize Distribution+Hydrometer,1-D: One-densional Consolidation,CU=Unconsolidated Comp.                  Mudline elevations determined from leadline measurements and Site tide gage levels</p>
---	---	---

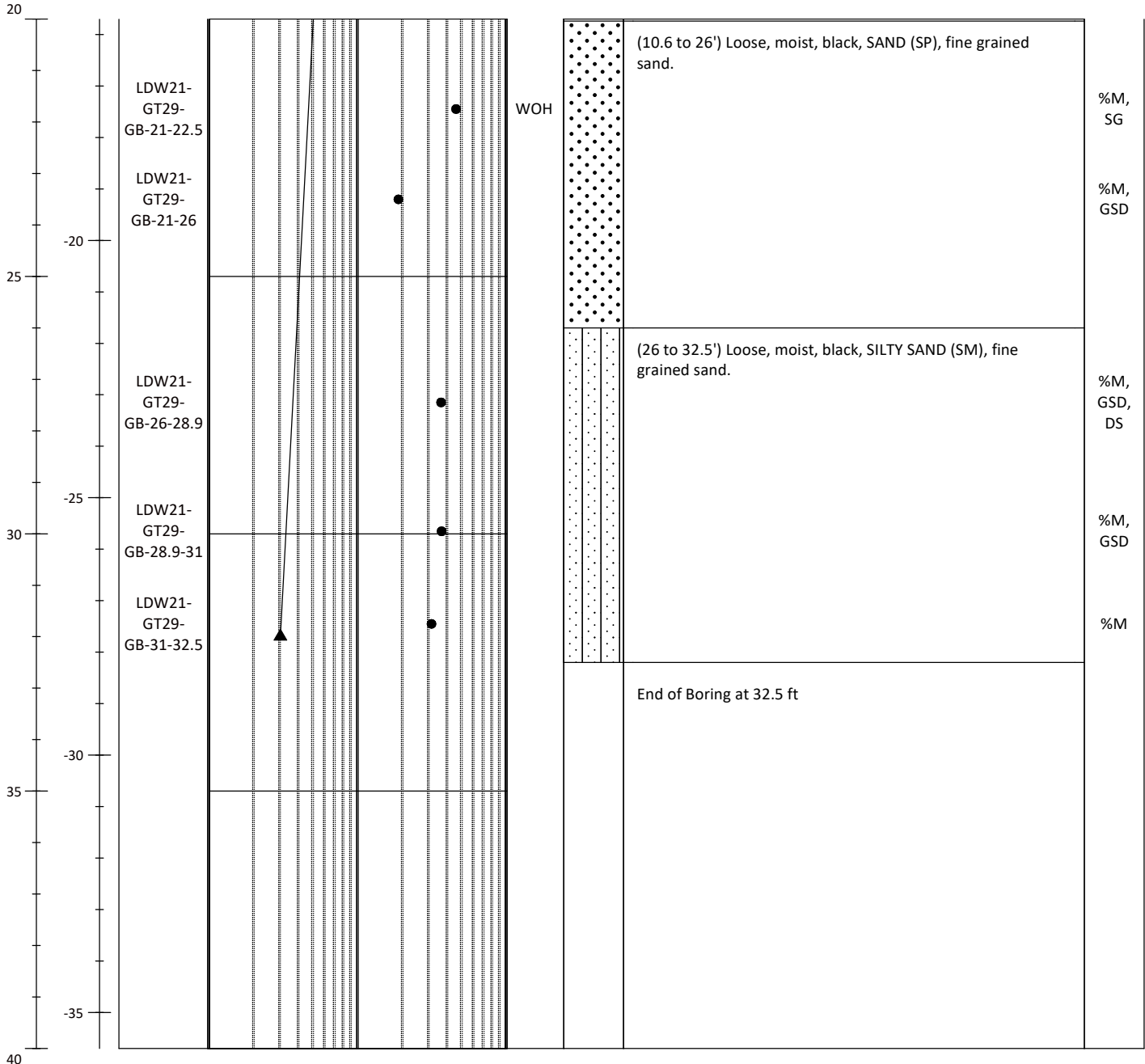
# [DRAFT] Soil Boring Log

## LDW21-GT29-GB

Sheet 2 of 2

Project #: <b>180067-02.03</b>	Project: <b>LDW Upper Reach Phase 2 Investigation</b>	Method: <b>Rotary Sonic</b>
Location: <b>Seattle, WA</b>	N/LAT: <b>193401.625</b> E/LONG: <b>1276568.528</b>	Total Depth (ft): <b>32.5</b>
Client: <b>Lower Duwamish Waterway Group</b>	Horiz. Datum: <b>Washington State Plane Coordinate North North American Datum of 1983, U.S. Feet</b>	Observed Depth to Mudline (ft): <b>5.0</b>
Collection Date: <b>07.14.21</b>		Mudline Elevation (ft): <b>4.3</b>
Contractor: <b>Holocene Drilling, Inc</b>	Vert. Datum: <b>Mean Lower Low Water (MLLW)</b>	Hammer: <b>140-lb, 30-in drop, Auto</b>
Logged By: <b>Casey Janisch</b>	Sampler(s): <b>Split Spoon &amp; Shelby Tube Sampler</b>	Hammer Efficiency (%): <b>99</b>

Depth (ft)	Elevation (ft)	Sample ID	Uncorrected Standard Penetration Resistance (blows per foot) and Moisture Content (%)						Other	Lithology	Soil Description Samples and descriptions are in recovered depths. Classification scheme: USCS	Lab Test
			1	2	5	10	20	50				



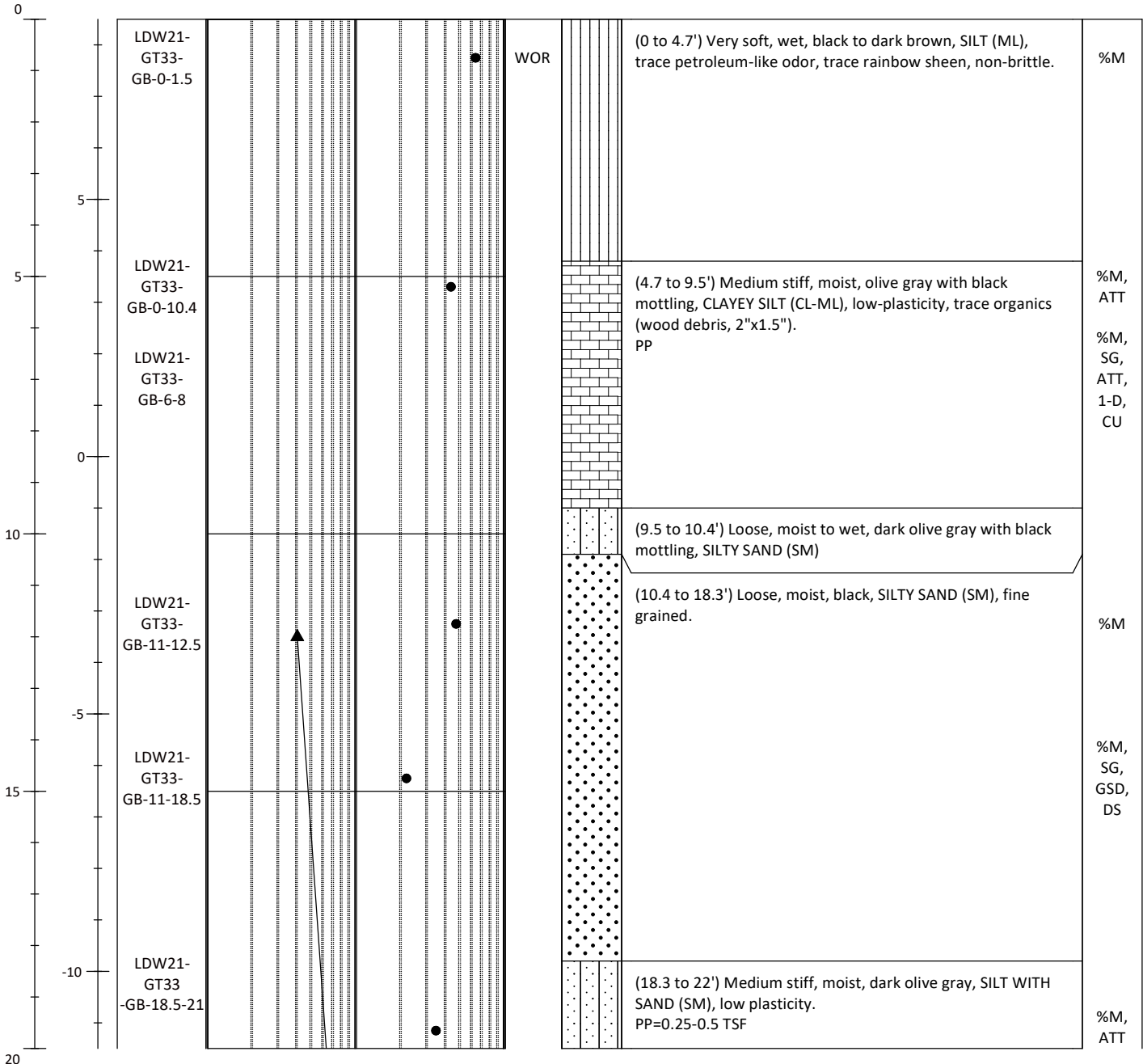
# [DRAFT] Soil Boring Log

## LDW21-GT33-GB

Sheet 1 of 2

Project #: <b>180067-02.03</b>	Project: <b>LDW Upper Reach Phase 2 Investigation</b>	Method: <b>Rotary Sonic</b>
Location: <b>Seattle, WA</b>	N/LAT: <b>193093.668</b> E/LONG: <b>1276612.259</b>	Total Depth (ft): <b>32.5</b>
Client: <b>Lower Duwamish Waterway Group</b>	Horiz. Datum: <b>Washington State Plane Coordinate North North American Datum of 1983, U.S. Feet</b>	Observed Depth to Mudline (ft): <b>0.1</b>
Collection Date: <b>07.15.21</b>		Mudline Elevation (ft): <b>8.5</b>
Contractor: <b>Holocene Drilling, Inc</b>	Vert. Datum: <b>Mean Lower Low Water (MLLW)</b>	Hammer: <b>140-lb, 30-in drop, Auto</b>
Logged By: <b>Casey Janisch</b>	Sampler(s): <b>Split Spoon &amp; Shelby Tube Sampler</b>	Hammer Efficiency (%): <b>99</b>

Depth (ft)	Elevation (ft)	Sample ID	Uncorrected Standard Penetration Resistance (blows per foot) and Moisture Content (%)						Other	Lithology	Soil Description Samples and descriptions are in recovered depths. Classification scheme: USCS	Lab Test
			1	2	5	10	20	50				



- ▲ SPT N-Value
- Moisture Content (%)

**Notes:**  
 %M=Percent Moisture Content, SG=Specific Gravity, ATT=Atterberg Limits, GSD=Grainsize Distribution, GSDH=Grainsize Distribution+Hydrometer, 1-D: One-dimensional Consolidation, CU=Unconsolidated Comp. Mudline elevations determined from leadline measurements and Site tide gage levels



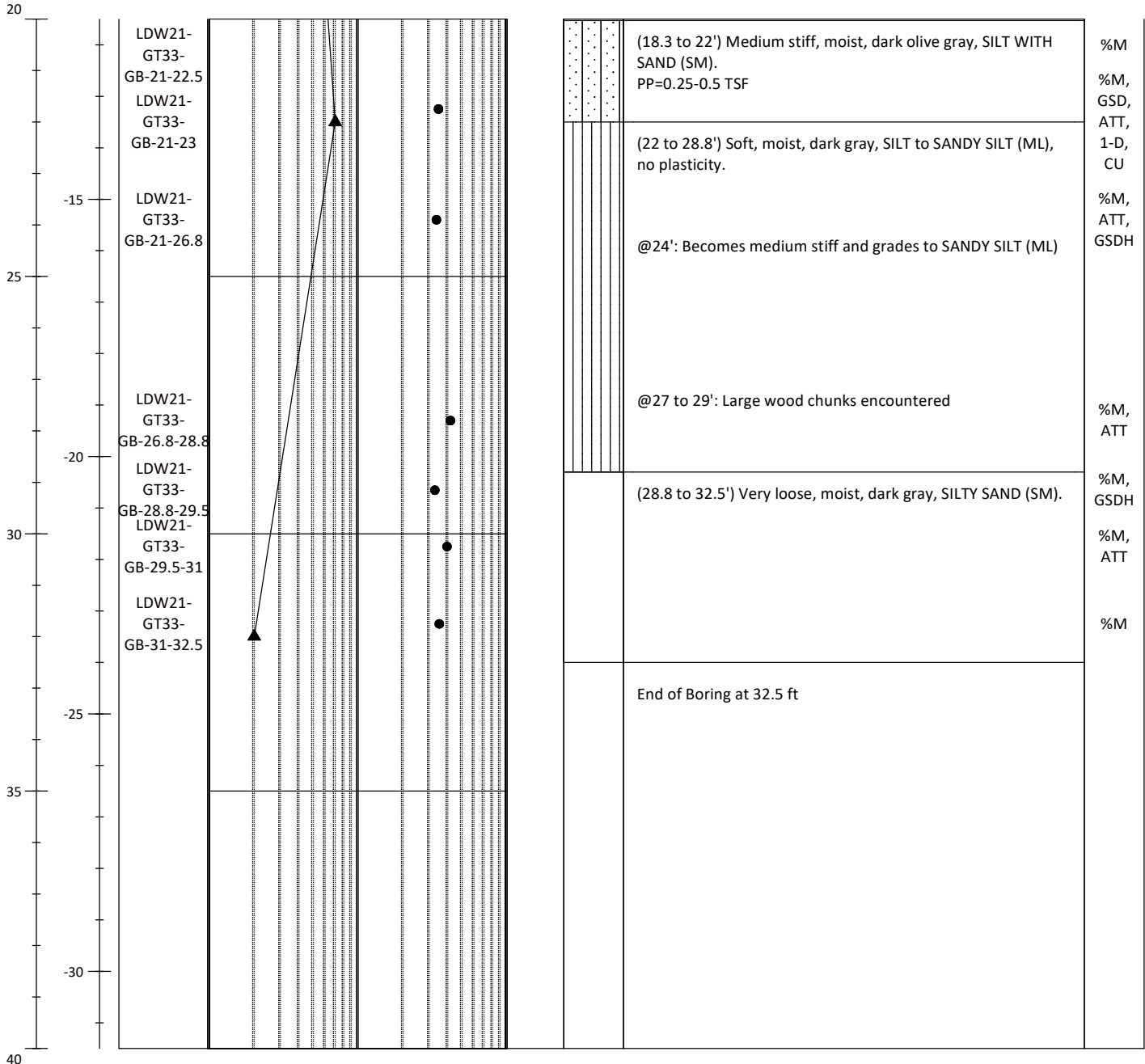
# [DRAFT] Soil Boring Log

## LDW21-GT33-GB

Sheet 2 of 2

Project #: <b>180067-02.03</b>	Project: <b>LDW Upper Reach Phase 2 Investigation</b>	Method: <b>Rotary Sonic</b>
Location: <b>Seattle, WA</b>	N/LAT: <b>193093.668</b> E/LONG: <b>1276612.259</b>	Total Depth (ft): <b>32.5</b>
Client: <b>Lower Duwamish Waterway Group</b>	Horiz. Datum: <b>Washington State Plane Coordinate North North American Datum of 1983, U.S. Feet</b>	Observed Depth to Mudline (ft): <b>0.1</b>
Collection Date: <b>07.15.21</b>		Mudline Elevation (ft): <b>8.5</b>
Contractor: <b>Holocene Drilling, Inc</b>	Vert. Datum: <b>Mean Lower Low Water (MLLW)</b>	Hammer: <b>140-lb, 30-in drop, Auto</b>
Logged By: <b>Casey Janisch</b>	Sampler(s): <b>Split Spoon &amp; Shelby Tube Sampler</b>	Hammer Efficiency (%): <b>99</b>

Depth (ft)	Elevation (ft)	Sample ID	Uncorrected Standard Penetration Resistance (blows per foot) and Moisture Content (%)						Other	Lithology	Soil Description Samples and descriptions are in recovered depths. Classification scheme: USCS	Lab Test
			1	2	5	10	20	50				



- ▲ SPT N-Value
- Moisture Content (%)

**Notes:**  
 %M=Percent Moisture Content, SG=Specific Gravity, ATT=Atterberg Limits, GSD=Grainsize Distribution, GSDH=Grainsize Distribution+Hydrometer, 1-D: One-dimensional Consolidation, CU=Unconsolidated Comp. Mudline elevations determined from leadline measurements and Site tide gage levels

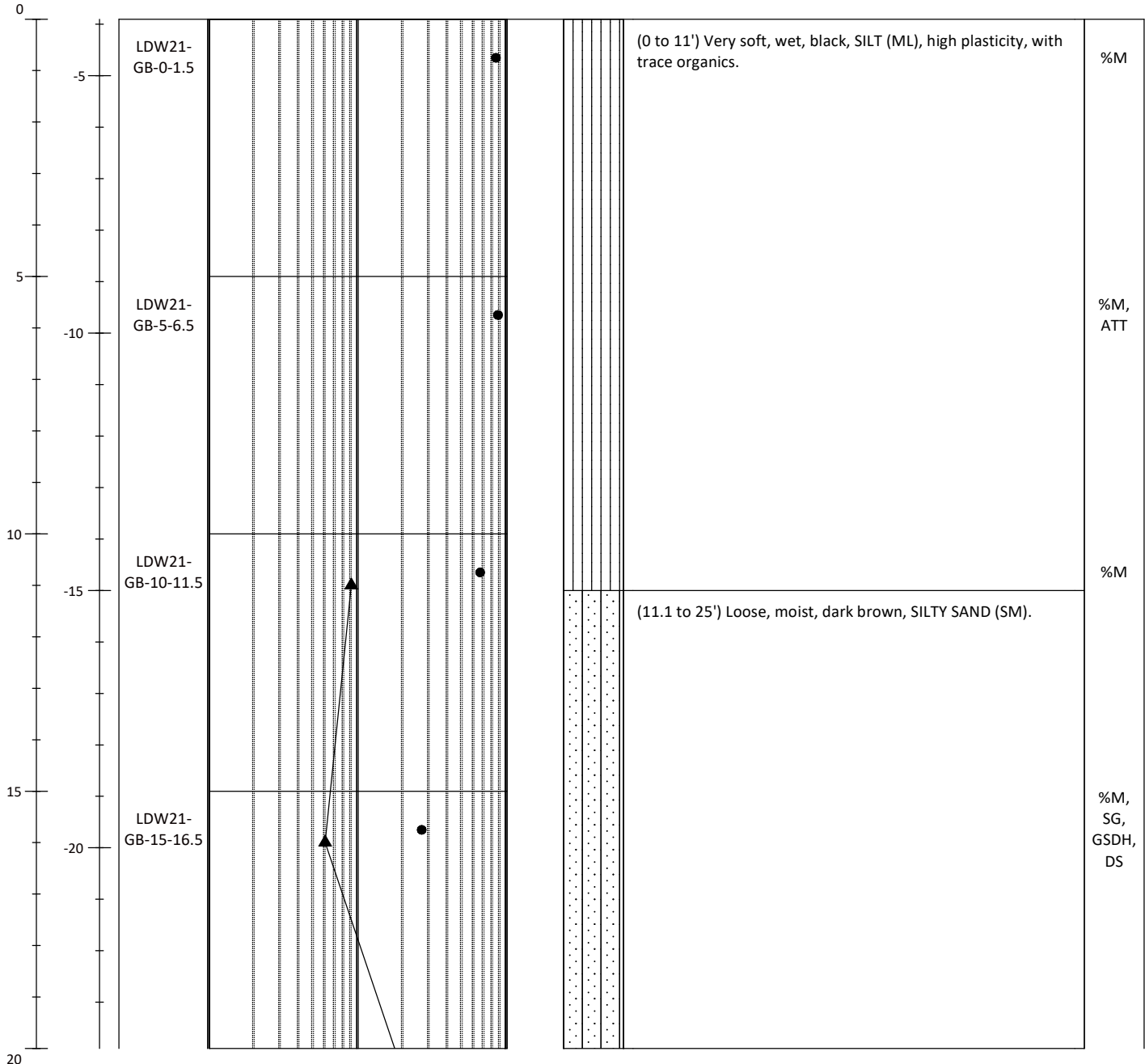
# [DRAFT] Soil Boring Log

## LDW-GT35-GB

Sheet 1 of 2

Project #: <b>180067-02.03</b>	Project: <b>LDW Upper Reach Phase 2 Investigation</b>	Method: <b>Rotary Sonic</b>
Location: <b>Seattle, WA</b>	N/LAT: <b>192818.4</b> E/LONG: <b>1277387</b>	Total Depth (ft): <b>31.5</b>
Client: <b>Lower Duwamish Waterway Group</b>	Horiz. Datum: <b>Washington State Plane Coordinate North North American Datum of 1983, U.S. Feet</b>	Observed Depth to Mudline (ft): <b>11.3</b>
Collection Date: <b>07.20.21</b>		Mudline Elevation (ft): <b>-3.9</b>
Contractor: <b>Holocene Drilling, Inc</b>	Vert. Datum: <b>Mean Lower Low Water (MLLW)</b>	Hammer: <b>140-lb, 30-in drop, Auto</b>
Logged By: <b>Casey Janisch</b>	Sampler(s): <b>Split Spoon &amp; Shelby Tube Sampler</b>	Hammer Efficiency (%): <b>99</b>

Depth (ft)	Elevation (ft)	Sample ID	Uncorrected Standard Penetration Resistance (blows per foot) and Moisture Content (%)						Other	Lithology	Soil Description Samples and descriptions are in recovered depths. Classification scheme: USCS	Lab Test
			1	2	5	10	20	100				



- ▲ SPT N-Value
- Moisture Content (%)

**Notes:**  
 %M=Percent Moisture Content, SG=Specific Gravity, ATT=Atterberg Limits, GSD=Grainsize Distribution, GSDH=Grainsize Distribution+Hydrometer, 1-D: One-dimensional Consolidation, CU=Unconsolidated Comp. Mudline elevations determined from leadline measurements and Site tide gage levels

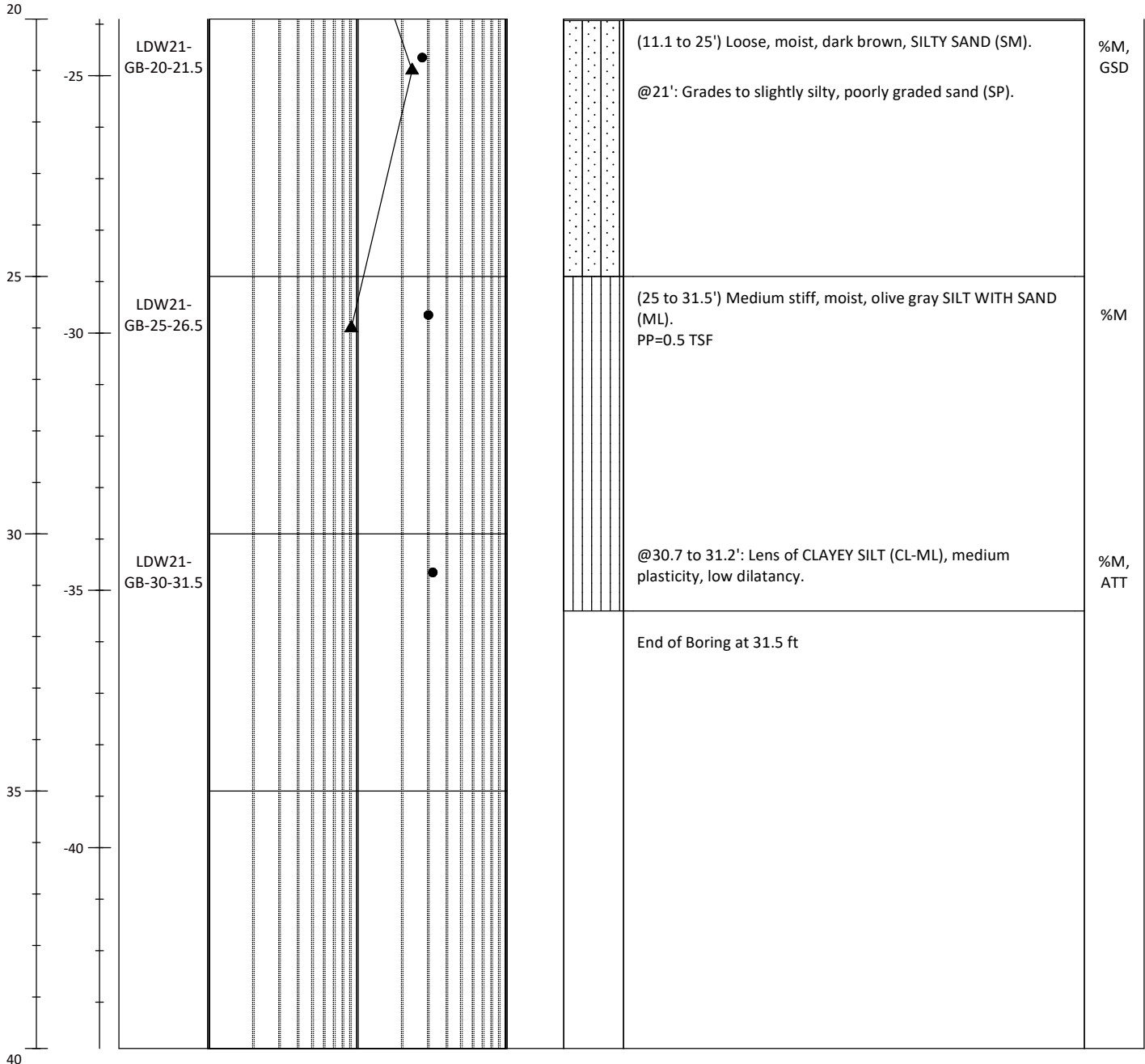
# [DRAFT] Soil Boring Log

## LDW-GT35-GB

Sheet 2 of 2

Project #: <b>180067-02.03</b>	Project: <b>LDW Upper Reach Phase 2 Investigation</b>	Method: <b>Rotary Sonic</b>
Location: <b>Seattle, WA</b>	N/LAT: <b>192818.4</b> E/LONG: <b>1277387</b>	Total Depth (ft): <b>31.5</b>
Client: <b>Lower Duwamish Waterway Group</b>	Horiz. Datum: <b>Washington State Plane Coordinate North North American Datum of 1983, U.S. Feet</b>	Observed Depth to Mudline (ft): <b>11.3</b>
Collection Date: <b>07.20.21</b>		Mudline Elevation (ft): <b>-3.9</b>
Contractor: <b>Holocene Drilling, Inc</b>	Vert. Datum: <b>Mean Lower Low Water (MLLW)</b>	Hammer: <b>140-lb, 30-in drop, Auto</b>
Logged By: <b>Casey Janisch</b>	Sampler(s): <b>Split Spoon &amp; Shelby Tube Sampler</b>	Hammer Efficiency (%): <b>99</b>

Depth (ft)	Elevation (ft)	Sample ID	Uncorrected Standard Penetration Resistance (blows per foot) and Moisture Content (%)						Other	Lithology	Soil Description Samples and descriptions are in recovered depths. Classification scheme: USCS	Lab Test
			1	2	5	10	20	50				



- ▲ SPT N-Value
- Moisture Content (%)

**Notes:**  
 %M=Percent Moisture Content, SG=Specific Gravity, ATT=Atterberg Limits, GSD=Grainsize Distribution,  
 GSDH=Grainsize Distribution+Hydrometer, 1-D: One-dimensional Consolidation, CU=Unconsolidated Comp.  
 Mudline elevations determined from leadline measurements and Site tide gage levels

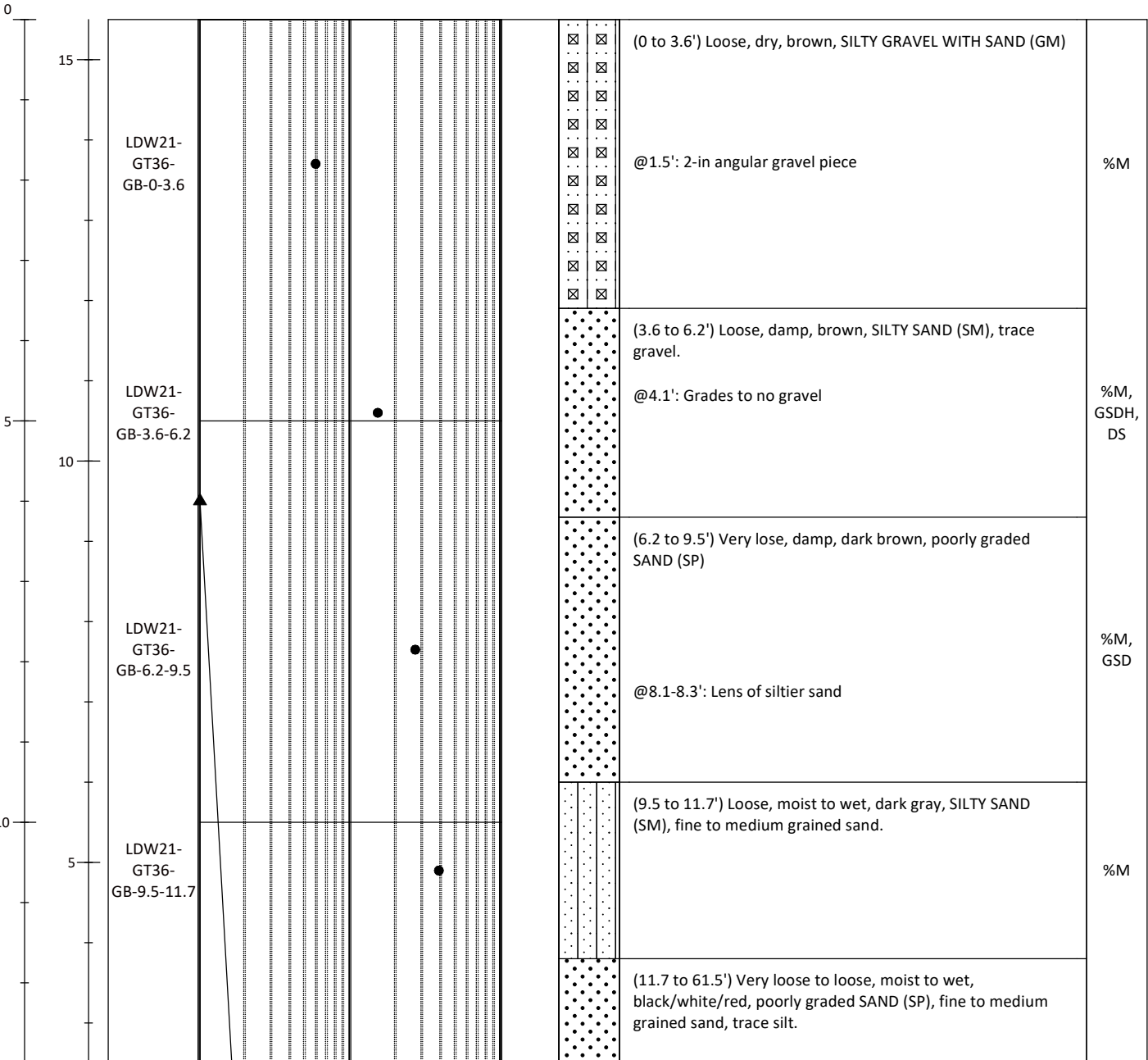
# [DRAFT] Soil Boring Log

## LDW21-GT36-GB

Sheet 1 of 5

Project #: <b>180067-02.03</b>	Project: <b>LDW Upper Reach Phase 2 Investigation</b>	Method: <b>Rotary Sonic</b>
Location: <b>Seattle, WA</b>	N/LAT: <b>192741.238</b> E/LONG: <b>1277403.821</b>	Total Depth (ft): <b>61.5</b>
Client: <b>Lower Duwamish Waterway Group</b>	Horiz. Datum: <b>Washington State Plane Coordinate North North American Datum of 1983, U.S. Feet</b>	Observed Depth to Mudline ( <del>NE</del> ):
Collection Date: <b>07.27.21</b>		Surface Elevation (ft): <b>15.5</b>
Contractor: <b>Holocene Drilling, Inc</b>	Vert. Datum: <b>Mean Lower Low Water (MLLW)</b>	Hammer: <b>140-lb, 30-in drop, Auto</b>
Logged By: <b>Sam Giannakos</b>	Sampler(s): <b>Split Spoon &amp; Shelby Tube Sampler</b>	Hammer Efficiency (%): <b>99</b>

Depth (ft)	Elevation (ft)	Sample ID	Uncorrected Standard Penetration Resistance (blows per foot) and Moisture Content (%)						Other	Lithology	Soil Description Samples and descriptions are in recovered depths. Classification scheme: USCS	Lab Test
			1	2	5	10	20	50				



- ▲ SPT N-Value
- Moisture Content (%)

**Notes:**  
 %M=Percent Moisture Content, SG=Specific Gravity, ATT=Atterberg Limits, GSD=Grainsize Distribution, GSDH=Grainsize Distribution+Hydrometer, 1-D: One-dimensional Consolidation, CU=Unconsolidated Comp. Elevation estimated using proposed location base map, no depth to mudline reported

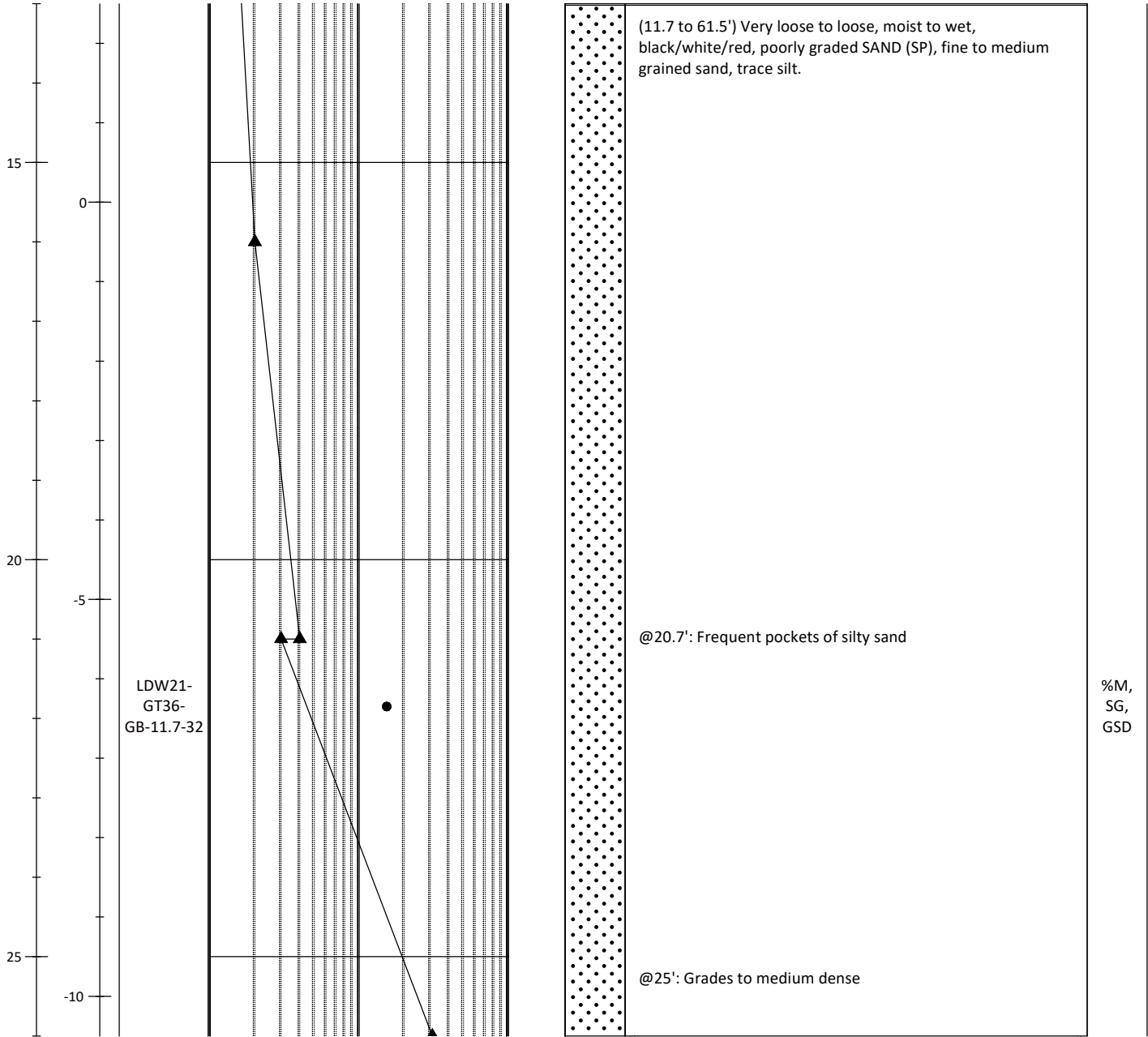
# [DRAFT] Soil Boring Log

## LDW21-GT36-GB

Sheet 2 of 5

Project #: <b>180067-02.03</b>	Project: <b>LDW Upper Reach Phase 2 Investigation</b>	Method: <b>Rotary Sonic</b>
Location: <b>Seattle, WA</b>	N/LAT: <b>192741.238</b> E/LONG: <b>1277403.821</b>	Total Depth (ft): <b>61.5</b>
Client: <b>Lower Duwamish Waterway Group</b>	Horiz. Datum: <b>Washington State Plane Coordinate North North American Datum of 1983, U.S. Feet</b>	Observed Depth to Mudline ( <del>NE</del> ):
Collection Date: <b>07.27.21</b>		Surface Elevation (ft): <b>15.5</b>
Contractor: <b>Holocene Drilling, Inc</b>	Vert. Datum: <b>Mean Lower Low Water (MLLW)</b>	Hammer: <b>140-lb, 30-in drop, Auto</b>
Logged By: <b>Sam Giannakos</b>	Sampler(s): <b>Split Spoon &amp; Shelby Tube Sampler</b>	Hammer Efficiency (%): <b>99</b>

Depth (ft)	Elevation (ft)	Sample ID	Uncorrected Standard Penetration Resistance (blows per foot) and Moisture Content (%)						Other	Lithology	Soil Description Samples and descriptions are in recovered depths. Classification scheme: USCS	Lab Test
			1	2	5	10	20	50				



%M,  
SG,  
GSD



- ▲ SPT N-Value
- Moisture Content (%)

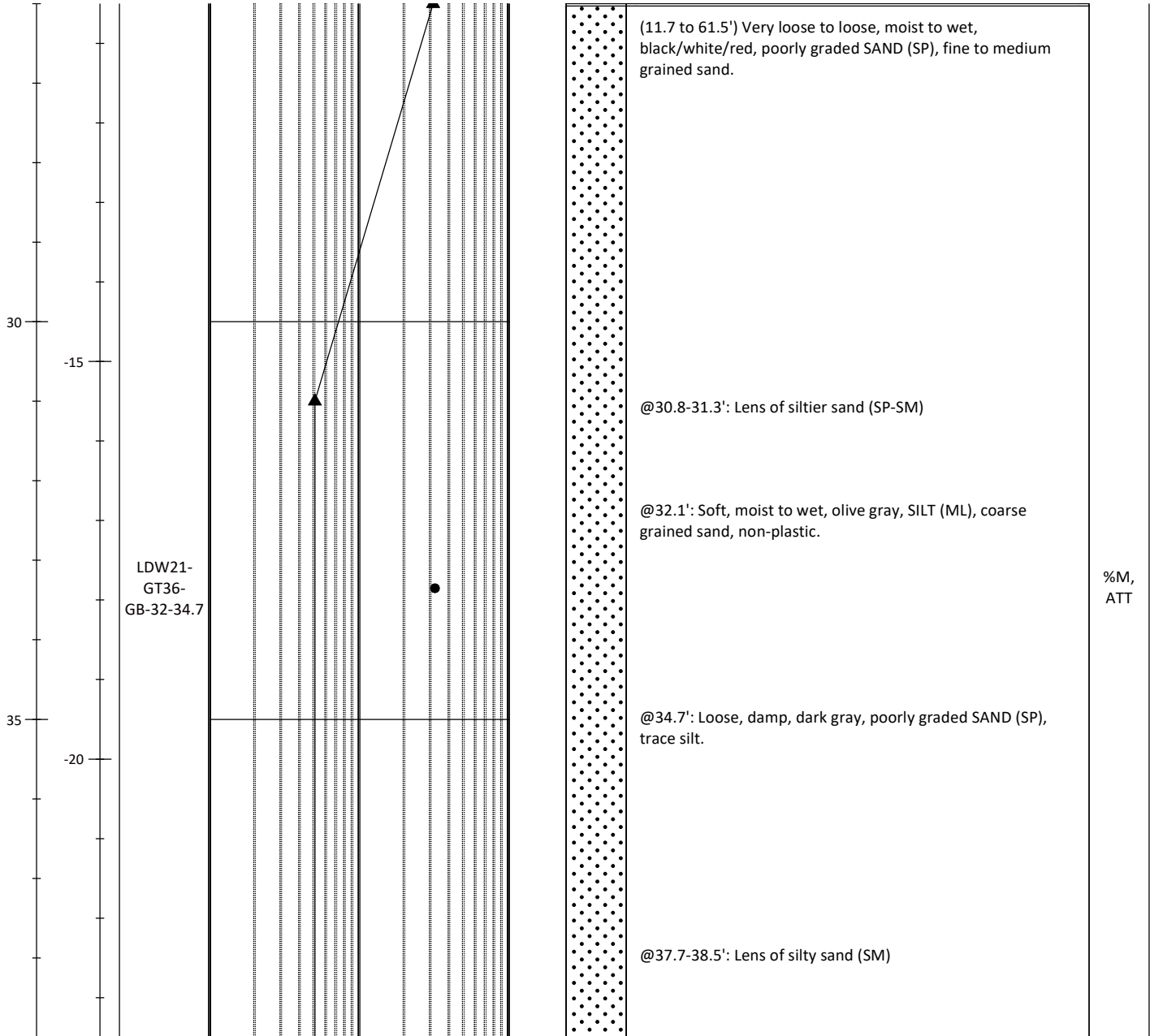
**Notes:**  
 %M=Percent Moisture Content, SG=Specific Gravity, ATT=Atterberg Limits, GSD=Grainsize Distribution, GSDH=Grainsize Distribution+Hydrometer, 1-D: One-dimensional Consolidation, CU=Unconsolidated Comp. Elevation estimated using proposed location base map, no depth to mudline reported

# [DRAFT] Soil Boring Log

## LDW21-GT36-GB

Project #: <b>180067-02.03</b>	Project: <b>LDW Upper Reach Phase 2 Investigation</b>	Method: <b>Rotary Sonic</b>
Location: <b>Seattle, WA</b>	N/LAT: <b>192741.238</b> E/LONG: <b>1277403.821</b>	Total Depth (ft): <b>61.5</b>
Client: <b>Lower Duwamish Waterway Group</b>	Horiz. Datum: <b>Washington State Plane Coordinate North North American Datum of 1983, U.S. Feet</b>	Observed Depth to Mudline ( <del>NE</del> ):
Collection Date: <b>07.27.21</b>		Surface Elevation (ft): <b>15.5</b>
Contractor: <b>Holocene Drilling, Inc</b>	Vert. Datum: <b>Mean Lower Low Water (MLLW)</b>	Hammer: <b>140-lb, 30-in drop, Auto</b>
Logged By: <b>Sam Giannakos</b>	Sampler(s): <b>Split Spoon &amp; Shelby Tube Sampler</b>	Hammer Efficiency (%): <b>99</b>

Depth (ft)	Elevation (ft)	Sample ID	Uncorrected Standard Penetration Resistance (blows per foot) and Moisture Content (%)						Other	Lithology	Soil Description Samples and descriptions are in recovered depths. Classification scheme: USCS	Lab Test
			1	2	5	10	20	50				



- ▲ SPT N-Value
- Moisture Content (%)

**Notes:**  
 %M=Percent Moisture Content,SG=Specific Gravity,ATT=Atterberg Limits,GSD=Grainsize Distribution,  
 GSDH=Grainsize Distribution+Hydrometer,1-D: One-densional Consolidation,CU=Unconsolidated Comp  
 Elevation estimated using proposed location base map, no depth to mudline reported

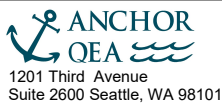
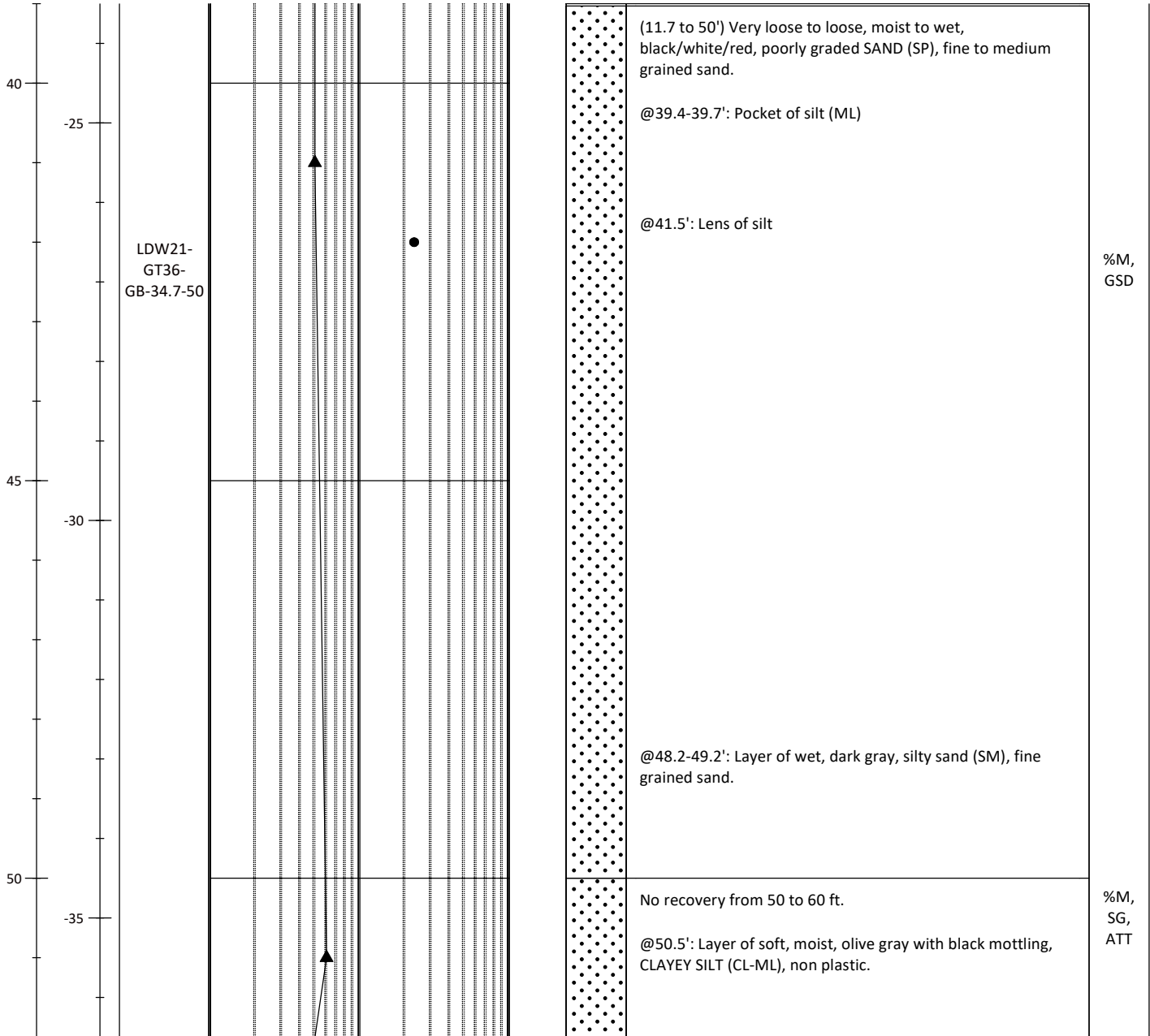
# [DRAFT] Soil Boring Log

## LDW21-GT36-GB

Sheet 4 of 5

Project #: <b>180067-02.03</b>	Project: <b>LDW Upper Reach Phase 2 Investigation</b>	Method: <b>Rotary Sonic</b>
Location: <b>Seattle, WA</b>	N/LAT: <b>192741.238</b> E/LONG: <b>1277403.821</b>	Total Depth (ft): <b>61.5</b>
Client: <b>Lower Duwamish Waterway Group</b>	Horiz. Datum: <b>Washington State Plane Coordinate North North American Datum of 1983, U.S. Feet</b>	Observed Depth to Mudline ( <del>NE</del> ):
Collection Date: <b>07.27.21</b>		Surface Elevation (ft): <b>15.5</b>
Contractor: <b>Holocene Drilling, Inc</b>	Vert. Datum: <b>Mean Lower Low Water (MLLW)</b>	Hammer: <b>140-lb, 30-in drop, Auto</b>
Logged By: <b>Sam Giannakos</b>	Sampler(s): <b>Split Spoon &amp; Shelby Tube Sampler</b>	Hammer Efficiency (%): <b>99</b>

Depth (ft)	Elevation (ft)	Sample ID	Uncorrected Standard Penetration Resistance (blows per foot) and Moisture Content (%)						Other	Lithology	Soil Description Samples and descriptions are in recovered depths. Classification scheme: USCS	Lab Test
			1	2	5	10	20	50				



- ▲ SPT N-Value
- Moisture Content (%)

**Notes:**  
 %M=Percent Moisture Content, SG=Specific Gravity, ATT=Atterberg Limits, GSD=Grainsize Distribution, GSDH=Grainsize Distribution+Hydrometer, 1-D: One-dimensional Consolidation, CU=Unconsolidated Comp  
 Elevation estimated using proposed location base map, no depth to mudline reported

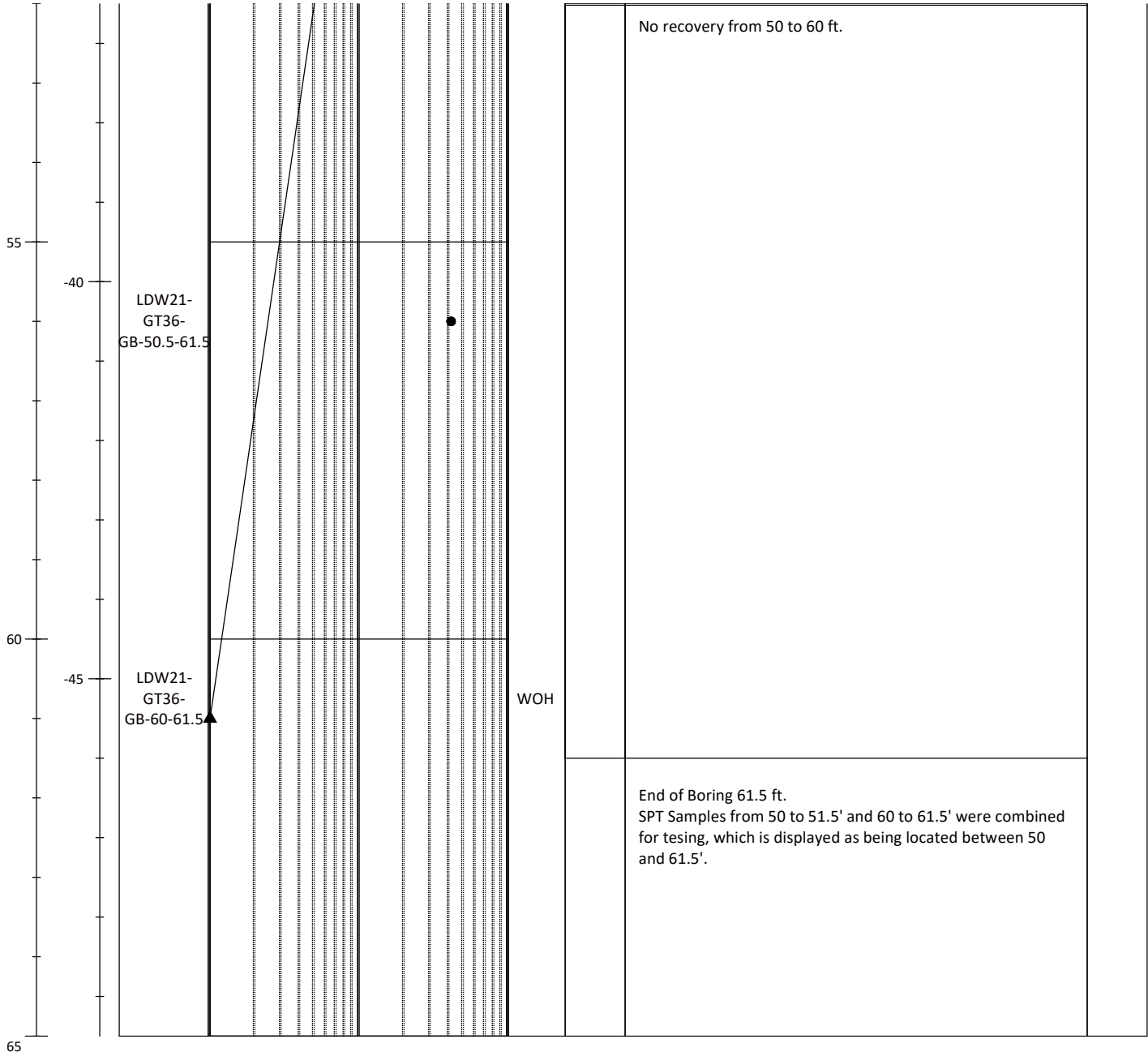
# [DRAFT] Soil Boring Log

## LDW21-GT36-GB

Sheet 5 of 5

Project #: <b>180067-02.03</b>	Project: <b>LDW Upper Reach Phase 2 Investigation</b>	Method: <b>Rotary Sonic</b>
Location: <b>Seattle, WA</b>	N/LAT: <b>192741.238</b> E/LONG: <b>1277403.821</b>	Total Depth (ft): <b>61.5</b>
Client: <b>Lower Duwamish Waterway Group</b>	Horiz. Datum: <b>Washington State Plane Coordinate North North American Datum of 1983, U.S. Feet</b>	Observed Depth to Mudline ( <del>NE</del> ):
Collection Date: <b>07.27.21</b>		Surface Elevation (ft): <b>15.5</b>
Contractor: <b>Holocene Drilling, Inc</b>	Vert. Datum: <b>Mean Lower Low Water (MLLW)</b>	Hammer: <b>140-lb, 30-in drop, Auto</b>
Logged By: <b>Sam Giannakos</b>	Sampler(s): <b>Split Spoon &amp; Shelby Tube Sampler</b>	Hammer Efficiency (%): <b>99</b>

Depth (ft)	Elevation (ft)	Sample ID	Uncorrected Standard Penetration Resistance (blows per foot) and Moisture Content (%)						Other	Lithology	Soil Description Samples and descriptions are in recovered depths. Classification scheme: USCS	Lab Test
			1	2	5	10	20	50				



- ▲ SPT N-Value
- Moisture Content (%)

**Notes:**  
 %M=Percent Moisture Content,SG=Specific Gravity,ATT=Atterberg Limits,GSD=Grainsize Distribution,  
 GSDH=Grainsize Distribution+Hydrometer,1-D: One-dimensional Consolidation,CU=Unconsolidated Comp  
 Elevation estimated using proposed location base map, no depth to mudline reported



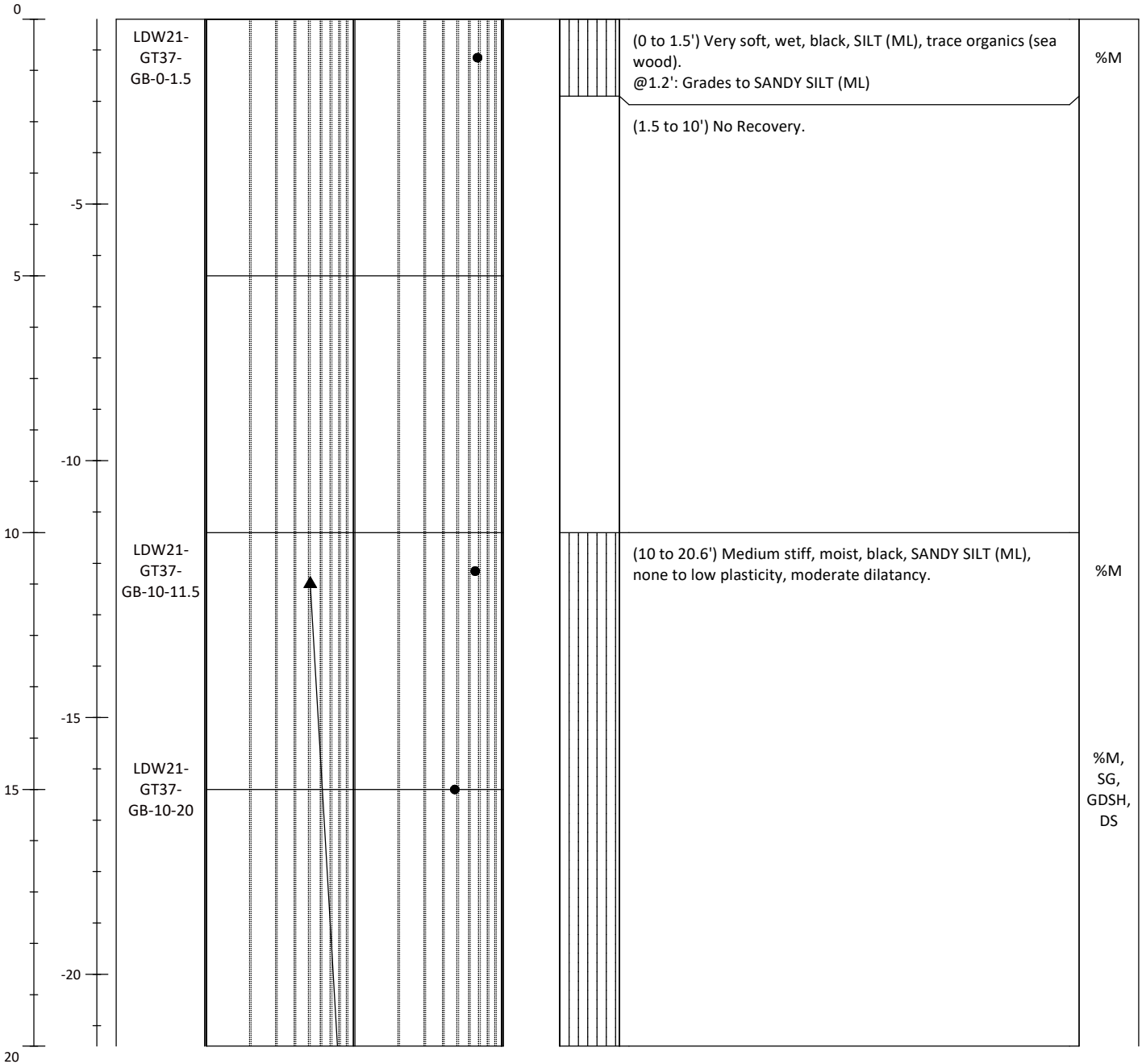
# [DRAFT] Soil Boring Log

## LDW21-GT37-GB

Sheet 1 of 2

Project #: 180067-02.03	Project: LDW Upper Reach Phase 2 Investigation	Method: Rotary Sonic
Location: Seattle, WA	N/LAT: 192182.064      E/LONG: 1276436.379	Total Depth (ft): 31.5
Client: Lower Duwamish Waterway Group	Horiz. Datum: Washington State Plane Coordinate North North American Datum of 1983, U.S. Feet	Observed Depth to Mudline (ft): 6.0
Collection Date: 07.14.21		Mudline Elevation (ft): -1.4
Contractor: Holocene Drilling, Inc	Vert. Datum: Mean Lower Low Water (MLLW)	Hammer: 140-lb, 30-in drop, Auto
Logged By: Casey Janisch	Sampler(s): Split Spoon & Shelby Tube Sampler	Hammer Efficiency (%): 99

Depth (ft)	Elevation (ft)	Sample ID	Uncorrected Standard Penetration Resistance (blows per foot) and Moisture Content (%)						Other	Lithology	Soil Description Samples and descriptions are in recovered depths. Classification scheme: USCS	Lab Test
			1	2	5	10	20	50				



- ▲ SPT N-Value
- Moisture Content (%)

**Notes:**  
 %M=Percent Moisture Content,SG=Specific Gravity,ATT=Atterberg Limits,GSD=Grainsize Distribution, GSDH=Grainsize Distribution+Hydrometer,1-D: One-dimensional Consolidation,CU=Unconsolidated Comp. Mudline elevations determined from leadline measurements and Site tide gage levels

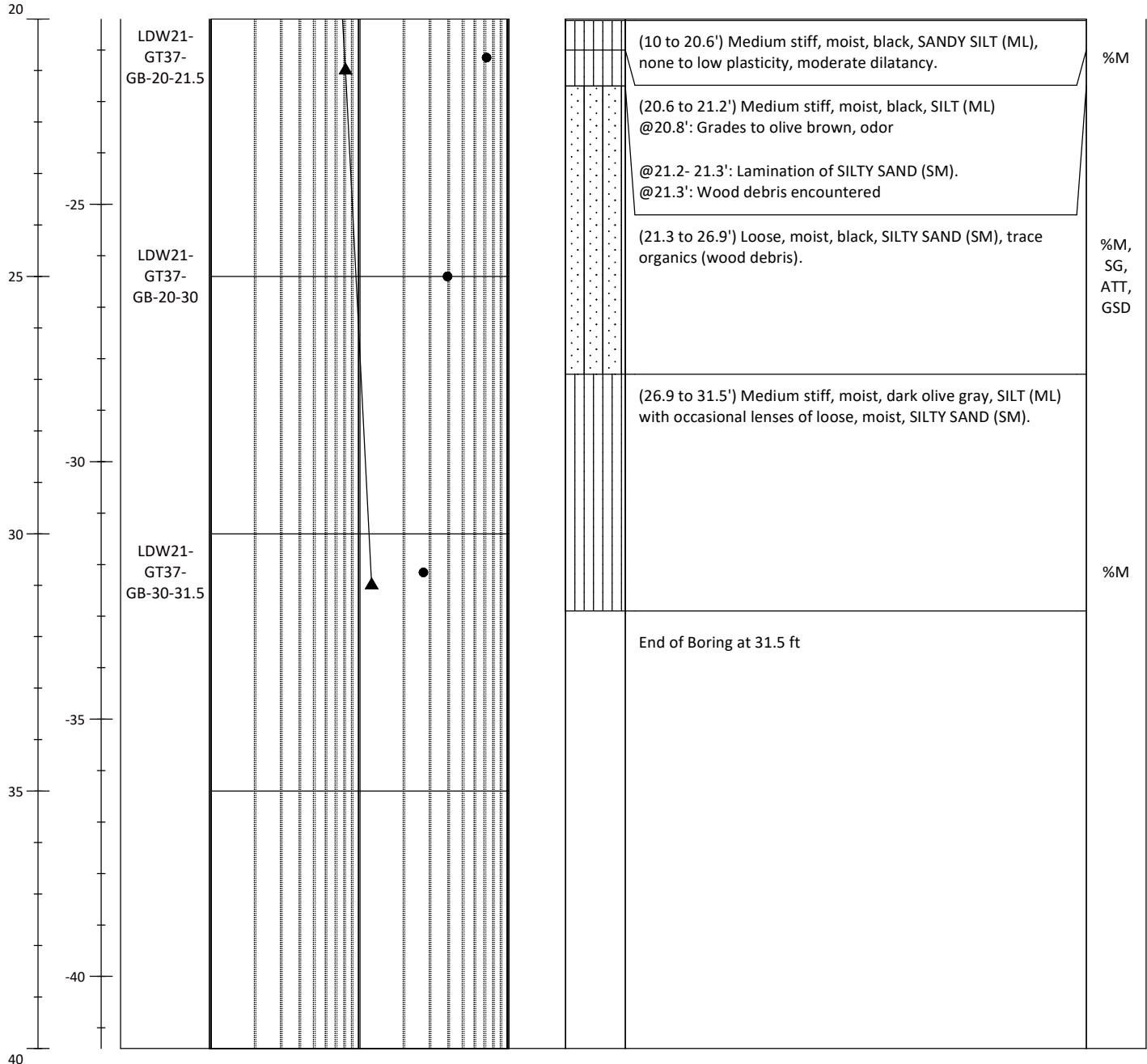
# [DRAFT] Soil Boring Log

## LDW21-GT37-GB

Sheet 2 of 2

Project #: <b>180067-02.03</b>	Project: <b>LDW Upper Reach Phase 2 Investigation</b>	Method: <b>Rotary Sonic</b>
Location: <b>Seattle, WA</b>	N/LAT: <b>192182.064</b> E/LONG: <b>1276436.379</b>	Total Depth (ft): <b>31.5</b>
Client: <b>Lower Duwamish Waterway Group</b>	Horiz. Datum: <b>Washington State Plane Coordinate North North American Datum of 1983, U.S. Feet</b>	Observed Depth to Mudline (ft): <b>6.0</b>
Collection Date: <b>07.14.21</b>		Mudline Elevation (ft): <b>-1.4</b>
Contractor: <b>Holocene Drilling, Inc</b>	Vert. Datum: <b>Mean Lower Low Water (MLLW)</b>	Hammer: <b>140-lb, 30-in drop, Auto</b>
Logged By: <b>Casey Janisch</b>	Sampler(s): <b>Split Spoon &amp; Shelby Tube Sampler</b>	Hammer Efficiency (%): <b>99</b>

Depth (ft)	Elevation (ft)	Sample ID	Uncorrected Standard Penetration Resistance (blows per foot) and Moisture Content (%)						Other	Lithology	Soil Description Samples and descriptions are in recovered depths. Classification scheme: USCS	Lab Test
			1	2	5	10	20	50				



- ▲ SPT N-Value
- Moisture Content (%)

**Notes:**  
 %M=Percent Moisture Content, SG=Specific Gravity, ATT=Atterberg Limits, GSD=Grainsize Distribution, GSDH=Grainsize Distribution+Hydrometer, 1-D: One-dimensional Consolidation, CU=Unconsolidated Comp. Mudline elevations determined from leadline measurements and Site tide gage levels

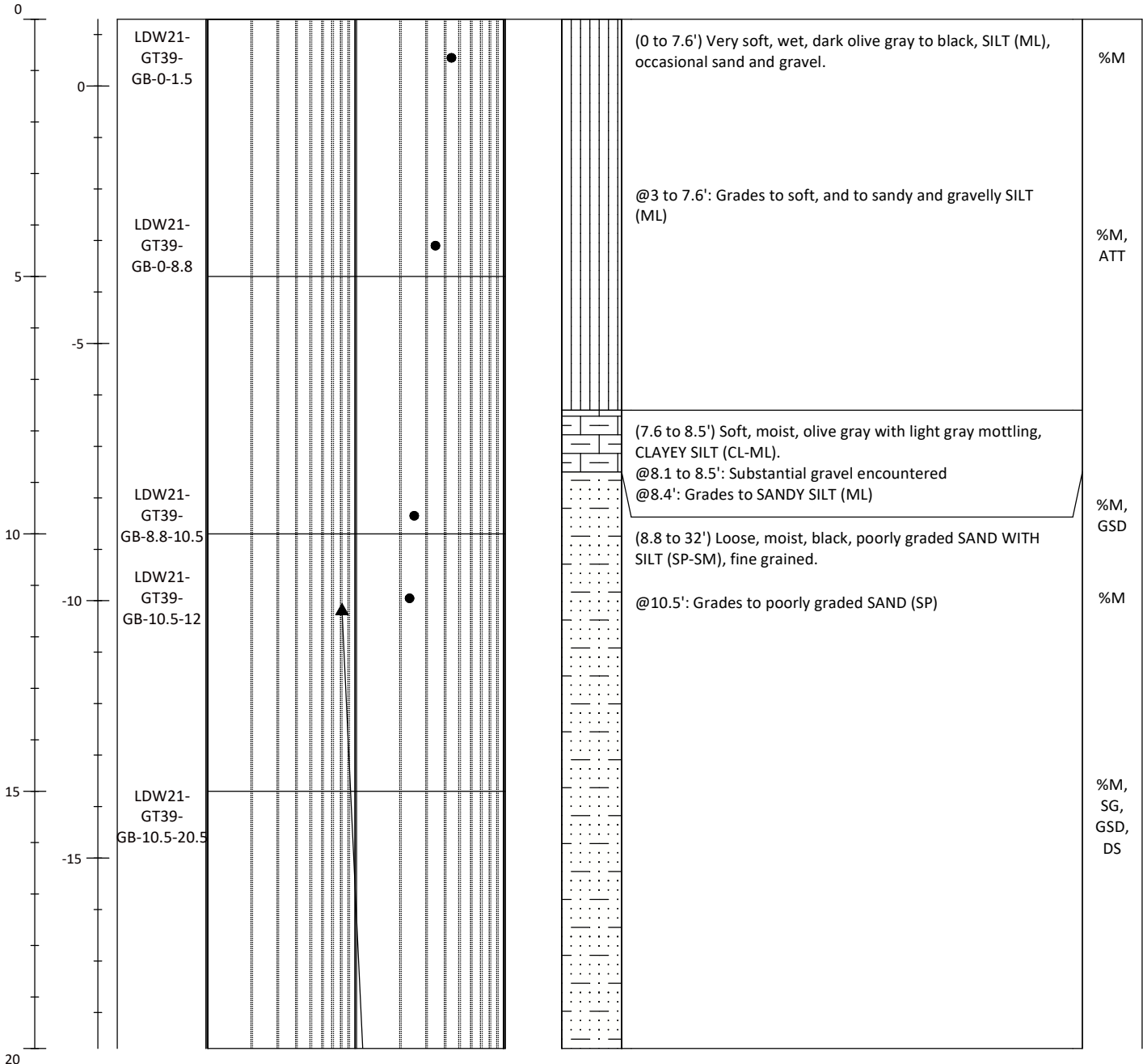
# [DRAFT] Soil Boring Log

## LDW21-GT39-GB

Sheet 1 of 2

Project #: <b>180067-02.03</b>	Project: <b>LDW Upper Reach Phase 2 Investigation</b>	Method: <b>Rotary Sonic</b>
Location: <b>Seattle, WA</b>	N/LAT: <b>190600.557</b> E/LONG: <b>1277362.3</b>	Total Depth (ft): <b>32</b>
Client: <b>Lower Duwamish Waterway Group</b>	Horiz. Datum: <b>Washington State Plane Coordinate North North American Datum of 1983, U.S. Feet</b>	Observed Depth to Mudline (ft): <b>5.5</b>
Collection Date: <b>07.16.21</b>		Mudline Elevation (ft): <b>1.3</b>
Contractor: <b>Holocene Drilling, Inc</b>	Vert. Datum: <b>Mean Lower Low Water (MLLW)</b>	Hammer: <b>140-lb, 30-in drop, Auto</b>
Logged By: <b>Casey Janisch</b>	Sampler(s): <b>Split Spoon &amp; Shelby Tube Sampler</b>	Hammer Efficiency (%): <b>99</b>

Depth (ft)	Elevation (ft)	Sample ID	Uncorrected Standard Penetration Resistance (blows per foot) and Moisture Content (%)						Other	Lithology	Soil Description Samples and descriptions are in recovered depths. Classification scheme: USCS	Lab Test
			1	2	5	10	20	50				



- ▲ SPT N-Value
- Moisture Content (%)

**Notes:**  
 %M=Percent Moisture Content, SG=Specific Gravity, ATT=Atterberg Limits, GSD=Grainsize Distribution, GSDH=Grainsize Distribution+Hydrometer, 1-D: One-dimensional Consolidation, CU=Unconsolidated Comp. Mudline elevations determined from leadline measurements and Site tide gage levels

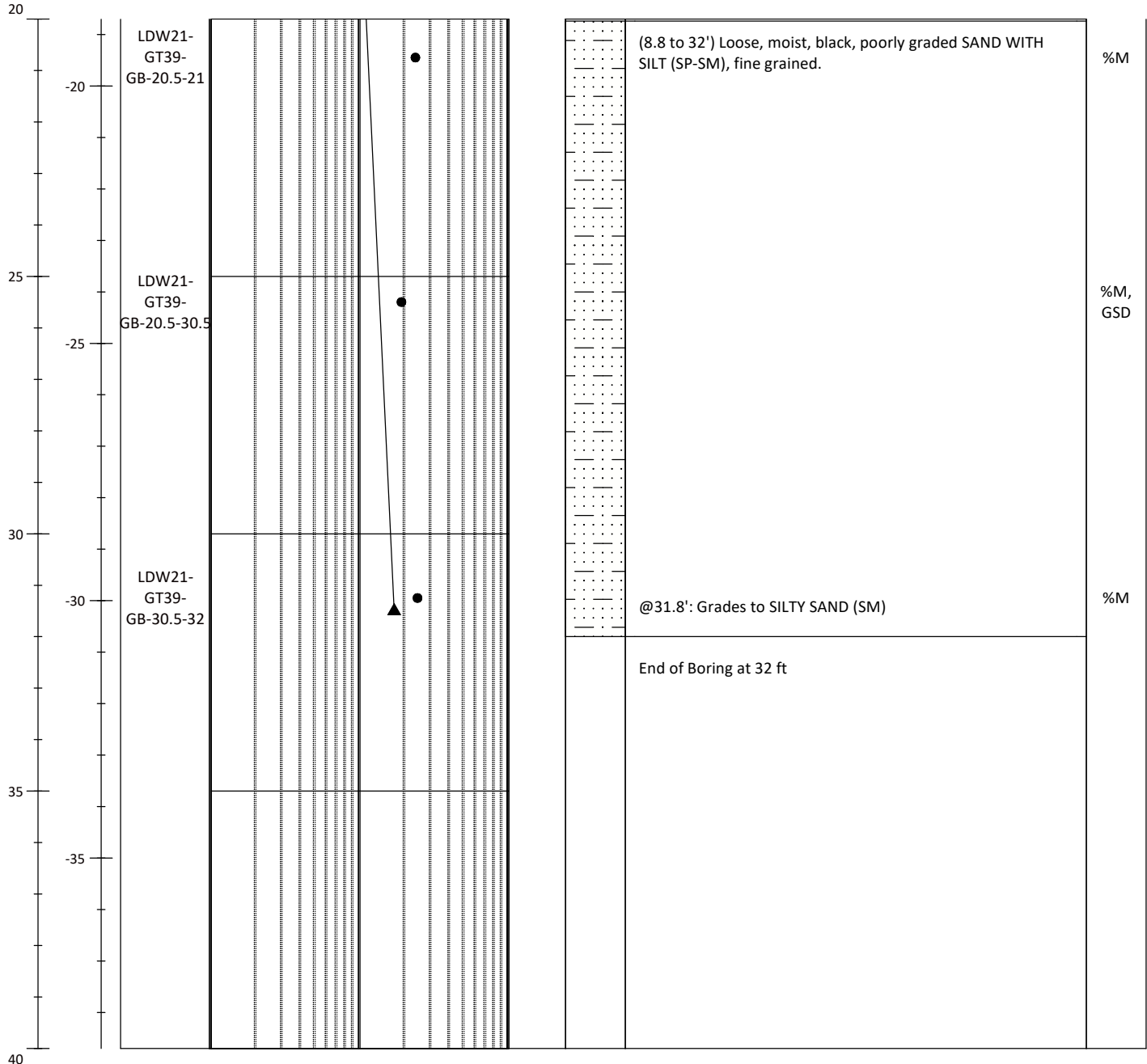
# [DRAFT] Soil Boring Log

## LDW21-GT39-GB

Sheet 2 of 2

Project #: <b>180067-02.03</b>	Project: <b>LDW Upper Reach Phase 2 Investigation</b>	Method: <b>Rotary Sonic</b>
Location: <b>Seattle, WA</b>	N/LAT: <b>190600.557</b> E/LONG: <b>1277362.3</b>	Total Depth (ft): <b>32</b>
Client: <b>Lower Duwamish Waterway Group</b>	Horiz. Datum: <b>Washington State Plane Coordinate North North American Datum of 1983, U.S. Feet</b>	Observed Depth to Mudline (ft): <b>5.5</b>
Collection Date: <b>07.16.21</b>		Mudline Elevation (ft): <b>1.3</b>
Contractor: <b>Holocene Drilling, Inc</b>	Vert. Datum: <b>Mean Lower Low Water (MLLW)</b>	Hammer: <b>140-lb, 30-in drop, Auto</b>
Logged By: <b>Casey Janisch</b>	Sampler(s): <b>Split Spoon &amp; Shelby Tube Sampler</b>	Hammer Efficiency (%): <b>99</b>

Depth (ft)	Elevation (ft)	Sample ID	Uncorrected Standard Penetration Resistance (blows per foot) and Moisture Content (%)						Other	Lithology	Soil Description Samples and descriptions are in recovered depths. Classification scheme: USCS	Lab Test
			1	2	5	10	20	50				



- ▲ SPT N-Value
- Moisture Content (%)

**Notes:**  
 %M=Percent Moisture Content, SG=Specific Gravity, ATT=Atterberg Limits, GSD=Grainsize Distribution, GSDH=Grainsize Distribution+Hydrometer, 1-D: One-dimensional Consolidation, CU=Unconsolidated Comp. Mudline elevations determined from leadline measurements and Site tide gage levels

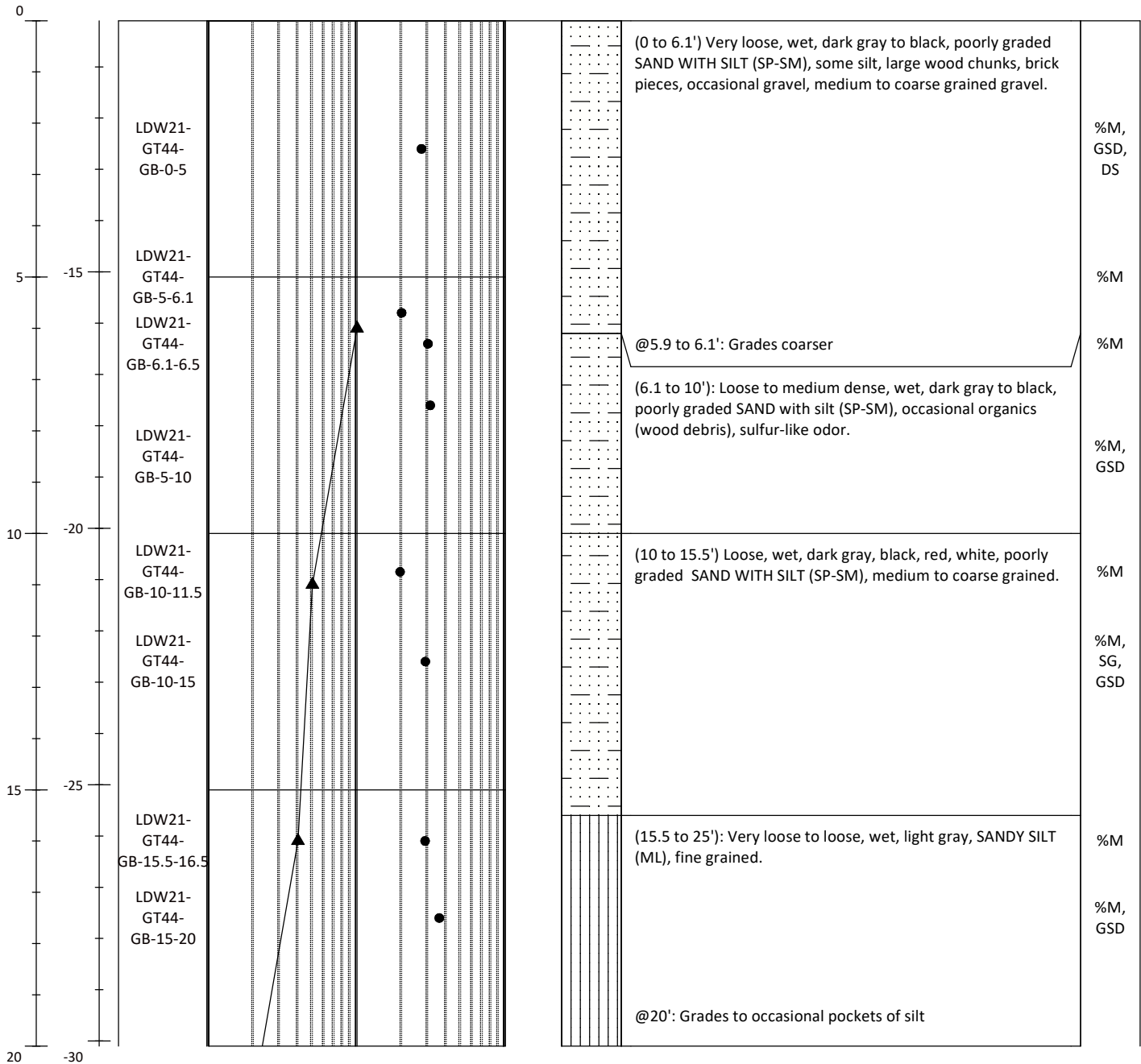
# [DRAFT] Soil Boring Log

## LDW21-GT44-GB

Sheet 1 of 2

Project #: <b>180067-02.03</b>	Project: <b>LDW Upper Reach Phase 2 Investigation</b>	Method: <b>Rotary Sonic</b>
Location: <b>Seattle, WA</b>	N/LAT: <b>190379.661</b> E/LONG: <b>1278233.2</b>	Total Depth (ft): <b>31.5</b>
Client: <b>Lower Duwamish Waterway Group</b>	Horiz. Datum: <b>Washington State Plane Coordinate North North American Datum of 1983, U.S. Feet</b>	Observed Depth to Mudline (ft): <b>18.5</b>
Collection Date: <b>08.04.21</b>		Mudline Elevation (ft): <b>-10.1</b>
Contractor: <b>Holocene Drilling, Inc</b>	Vert. Datum: <b>Mean Lower Low Water (MLLW)</b>	Hammer: <b>140-lb, 30-in drop, Auto</b>
Logged By: <b>Garrett Timm</b>	Sampler(s): <b>Split Spoon &amp; Shelby Tube Sampler</b>	Hammer Efficiency (%): <b>99</b>

Depth (ft)	Elevation (ft)	Sample ID	Uncorrected Standard Penetration Resistance (blows per foot) and Moisture Content (%)						Other	Lithology	Soil Description Samples and descriptions are in recovered depths. Classification scheme: USCS	Lab Test
			1	2	5	10	20	50				



- ▲ SPT N-Value
- Moisture Content (%)

**Notes:**  
 %M=Percent Moisture Content, SG=Specific Gravity, ATT=Atterberg Limits, GSD=Grainsize Distribution, GSDH=Grainsize Distribution+Hydrometer, 1-D: One-dimensional Consolidation, CU=Unconsolidated Comp. Mudline elevations determined from leadline measurements and Site tide gage levels

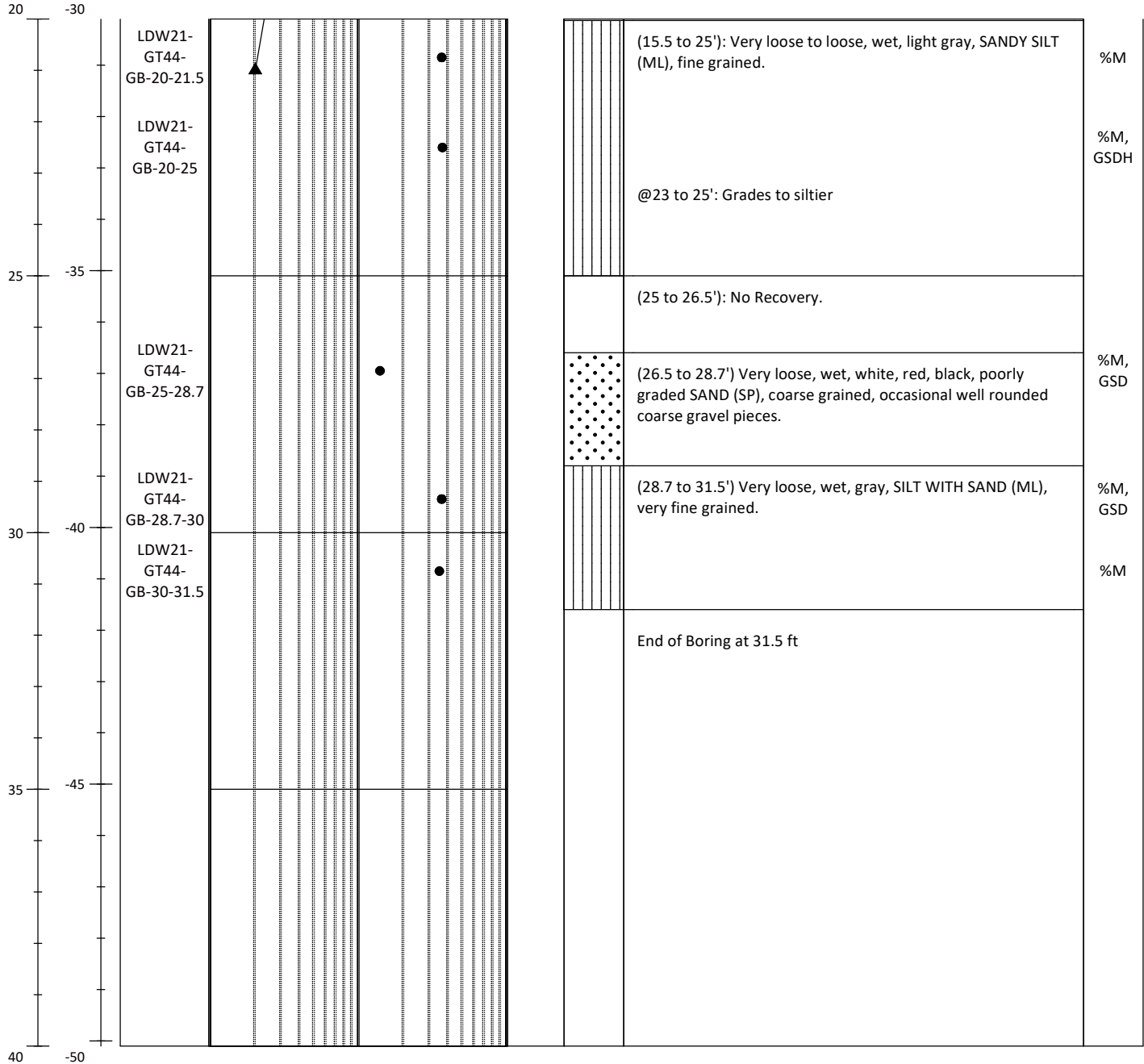
# [DRAFT] Soil Boring Log

## LDW21-GT44-GB

Sheet 2 of 2

Project #: <b>180067-02.03</b>	Project: <b>LDW Upper Reach Phase 2 Investigation</b>	Method: <b>Rotary Sonic</b>
Location: <b>Seattle, WA</b>	N/LAT: <b>190379.661</b> E/LONG: <b>1278233.2</b>	Total Depth (ft): <b>31.5</b>
Client: <b>Lower Duwamish Waterway Group</b>	Horiz. Datum: <b>Washington State Plane Coordinate North North American Datum of 1983, U.S. Feet</b>	Observed Depth to Mudline (ft): <b>18.5</b>
Collection Date: <b>08.04.21</b>		Mudline Elevation (ft): <b>-10.1</b>
Contractor: <b>Holocene Drilling, Inc</b>	Vert. Datum: <b>Mean Lower Low Water (MLLW)</b>	Hammer: <b>140-lb, 30-in drop, Auto</b>
Logged By: <b>Garrett Timm</b>	Sampler(s): <b>Split Spoon &amp; Shelby Tube Sampler</b>	Hammer Efficiency (%): <b>99</b>

Depth (ft)	Elevation (ft)	Sample ID	Uncorrected Standard Penetration Resistance (blows per foot) and Moisture Content (%)						Other	Lithology	Soil Description Samples and descriptions are in recovered depths. Classification scheme: USCS	Lab Test
			1	2	5	10	20	50				



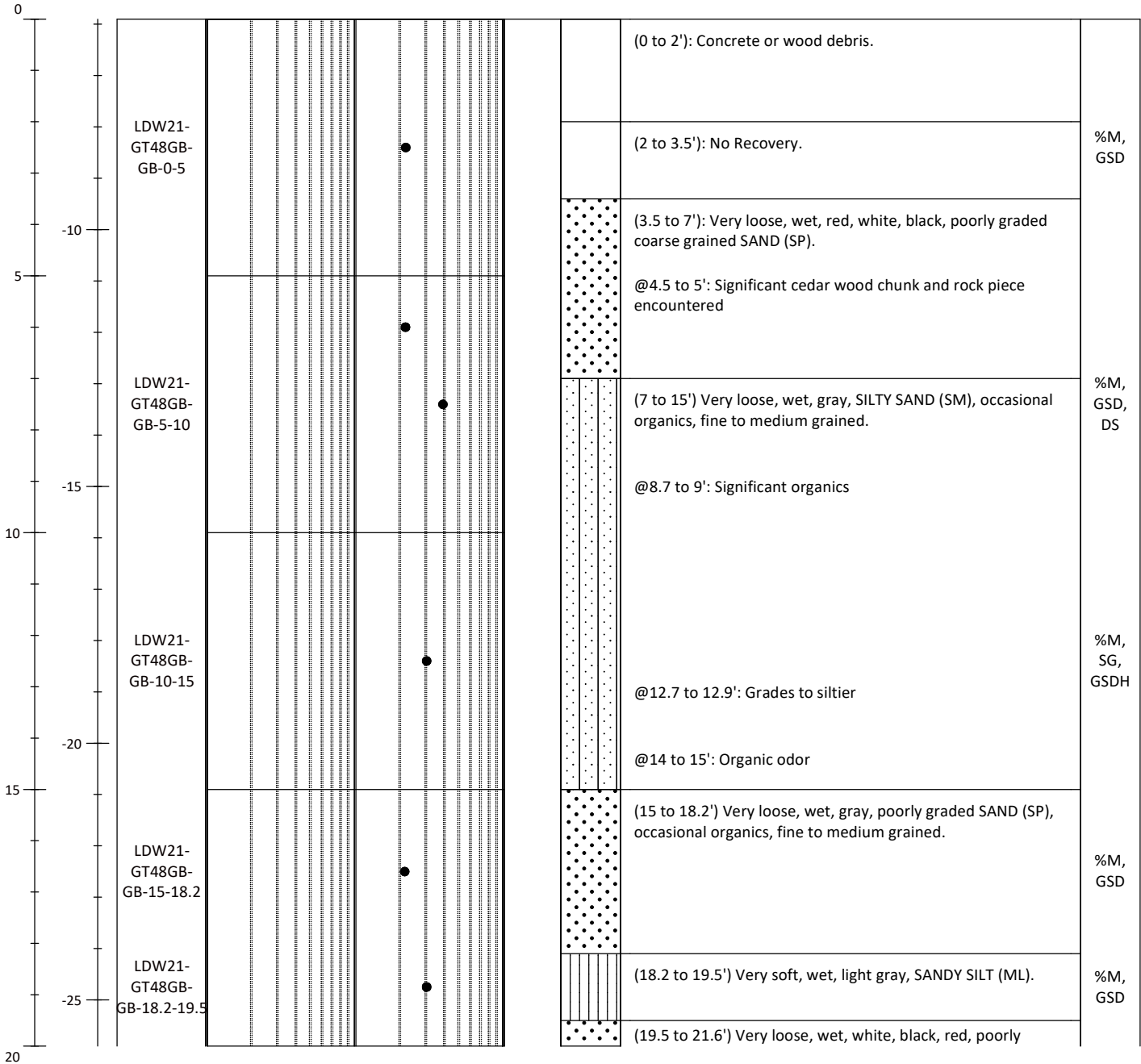
<p>1201 Third Avenue Suite 2600 Seattle, WA 98101</p>	<ul style="list-style-type: none"> <li>▲ SPT N-Value</li> <li>● Moisture Content (%)</li> </ul>	<p><b>Notes:</b>                  %M=Percent Moisture Content, SG=Specific Gravity, ATT=Atterberg Limits, GSD=Grainsize Distribution, GSDH=Grainsize Distribution+Hydrometer, 1-D: One-dimensional Consolidation, CU=Unconsolidated Comp. Mudline elevations determined from leadline measurements and Site tide gage levels</p>
---	---	--

# [DRAFT] Soil Boring Log

## LDW21-GT48-GB

Project #: <b>180067-02.03</b>	Project: <b>LDW Upper Reach Phase 2 Investigation</b>	Method: <b>Rotary Sonic</b>
Location: <b>Seattle, WA</b>	N/LAT: <b>190317.6</b> E/LONG: <b>1278379.433</b>	Total Depth (ft): <b>35</b>
Client: <b>Lower Duwamish Waterway Group</b>	Horiz. Datum: <b>Washington State Plane Coordinate North North American Datum of 1983, U.S. Feet</b>	Observed Depth to Mudline (ft): <b>12</b>
Collection Date: <b>08.05.21</b>		Mudline Elevation (ft): <b>-5.9</b>
Contractor: <b>Holocene Drilling, Inc</b>	Vert. Datum: <b>Mean Lower Low Water (MLLW)</b>	Hammer: <b>140-lb, 30-in drop, Auto</b>
Logged By: <b>Garrett Timm</b>	Sampler(s): <b>Split Spoon &amp; Shelby Tube Sampler</b>	Hammer Efficiency (%): <b>99</b>

Depth (ft)	Elevation (ft)	Sample ID	Uncorrected Standard Penetration Resistance (blows per foot) and Moisture Content (%)						Other	Lithology	Soil Description Samples and descriptions are in recovered depths. Classification scheme: USCS	Lab Test
			1	2	5	10	20	50				



- ▲ SPT N-Value
- Moisture Content (%)

**Notes:**  
 %M=Percent Moisture Content, SG=Specific Gravity, ATT=Atterberg Limits, GSD=Grainsize Distribution, GSDH=Grainsize Distribution+Hydrometer, 1-D: One-dimensional Consolidation, CU=Unconsolidated Comp. Mudline elevations determined from leadline measurements and Site tide gage levels

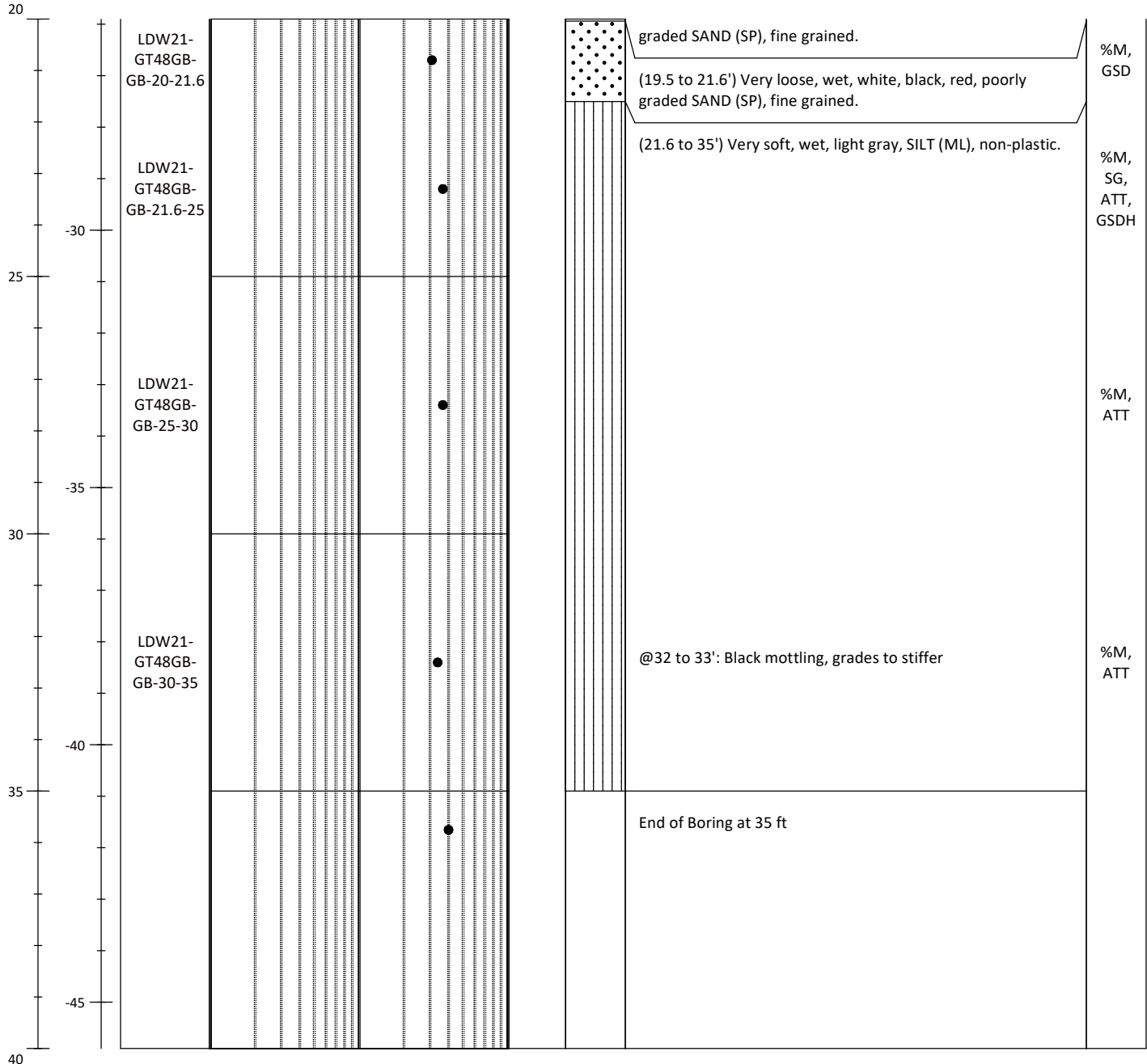
# [DRAFT] Soil Boring Log

## LDW21-GT48-GB

Sheet 2 of 2

Project #: <b>180067-02.03</b>	Project: <b>LDW Upper Reach Phase 2 Investigation</b>	Method: <b>Rotary Sonic</b>
Location: <b>Seattle, WA</b>	N/LAT: <b>190317.6</b> E/LONG: <b>1278379.433</b>	Total Depth (ft): <b>35</b>
Client: <b>Lower Duwamish Waterway Group</b>	Horiz. Datum: <b>Washington State Plane Coordinate North North American Datum of 1983, U.S. Feet</b>	Observed Depth to Mudline (ft): <b>12</b>
Collection Date: <b>08.05.21</b>		Mudline Elevation (ft): <b>-5.9</b>
Contractor: <b>Holocene Drilling, Inc</b>	Vert. Datum: <b>Mean Lower Low Water (MLLW)</b>	Hammer: <b>140-lb, 30-in drop, Auto</b>
Logged By: <b>Garrett Timm</b>	Sampler(s): <b>Split Spoon &amp; Shelby Tube Sampler</b>	Hammer Efficiency (%): <b>99</b>

Depth (ft)	Elevation (ft)	Sample ID	Uncorrected Standard Penetration Resistance (blows per foot) and Moisture Content (%)						Other	Lithology	Soil Description Samples and descriptions are in recovered depths. Classification scheme: USCS	Lab Test
			1	2	5	10	20	50				



- ▲ SPT N-Value
- Moisture Content (%)

**Notes:**  
 %M=Percent Moisture Content, SG=Specific Gravity, ATT=Atterberg Limits, GSD=Grainsize Distribution, GSDH=Grainsize Distribution+Hydrometer, 1-D: One-dimensional Consolidation, CU=Unconsolidated Comp. Mudline elevations determined from leadline measurements and Site tide gage levels



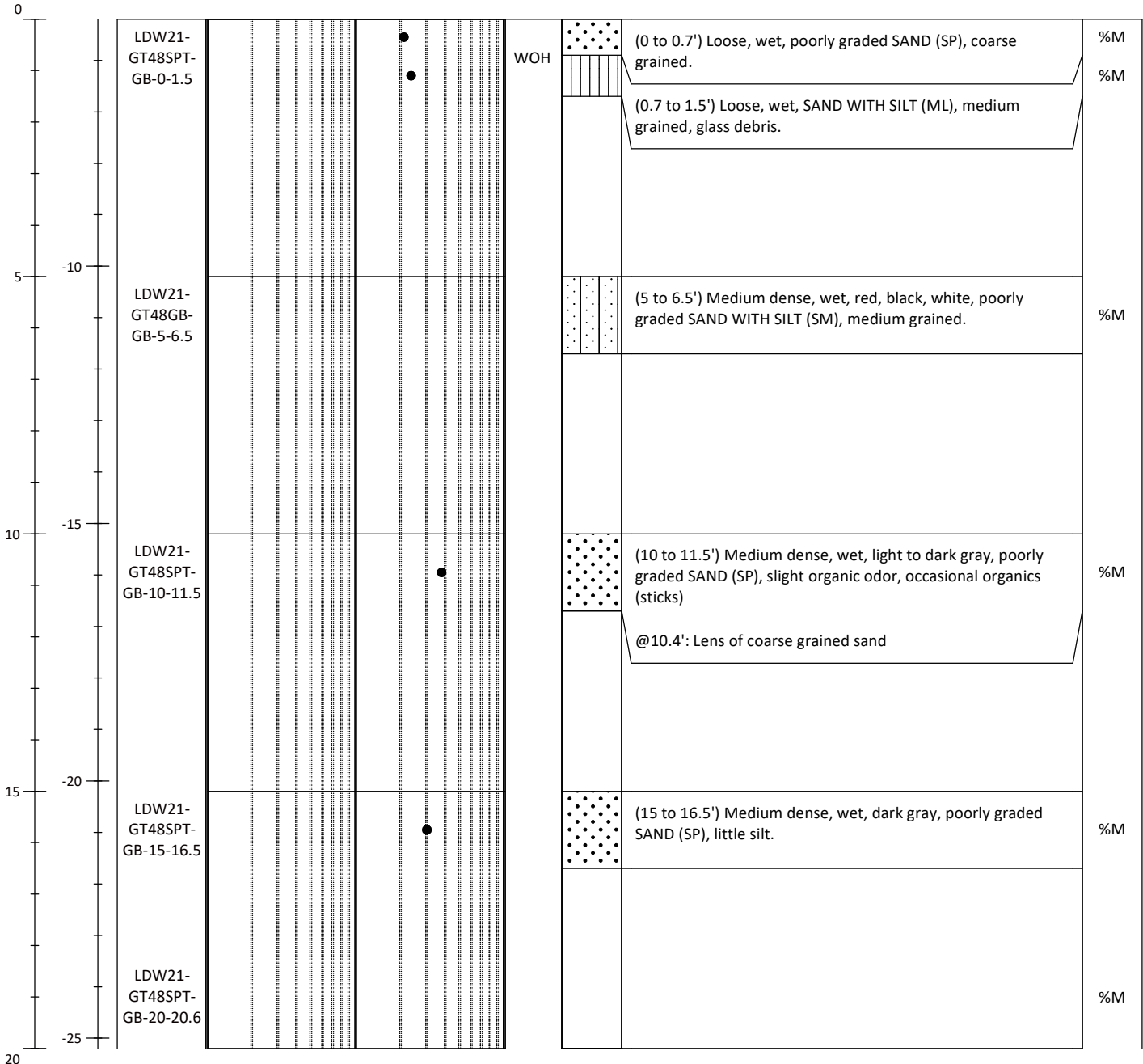
# [DRAFT] Soil Boring Log

## LDW21-GT48-SPT

Sheet 1 of 2

Project #: <b>180067-02.03</b>	Project: <b>LDW Upper Reach Phase 2 Investigation</b>	Method: <b>Rotary Sonic</b>
Location: <b>Seattle, WA</b>	N/LAT: <b>190313.244</b> E/LONG: <b>1278382.172</b>	Total Depth (ft): <b>36.5</b>
Client: <b>Lower Duwamish Waterway Group</b>	Horiz. Datum: <b>Washington State Plane Coordinate North North American Datum of 1983, U.S. Feet</b>	Observed Depth to Mudline (ft): <b>14.0</b>
Collection Date: <b>08.05.21</b>		Mudline Elevation (ft): <b>-5.2</b>
Contractor: <b>Holocene Drilling, Inc</b>	Vert. Datum: <b>Mean Lower Low Water (MLLW)</b>	Hammer: <b>140-lb, 30-in drop, Auto</b>
Logged By: <b>Garrett Timm</b>	Sampler(s): <b>Split Spoon &amp; Shelby Tube Sampler</b>	Hammer Efficiency (%): <b>99</b>

Depth (ft)	Elevation (ft)	Sample ID	Uncorrected Standard Penetration Resistance (blows per foot) and Moisture Content (%)						Other	Lithology	Soil Description Samples and descriptions are in recovered depths. Classification scheme: USCS	Lab Test
			1	2	5	10	20	50				



- ▲ SPT N-Value
- Moisture Content (%)

**Notes:**  
 %M=Percent Moisture Content,SG=Specific Gravity,ATT=Atterberg Limits,GSD=Grainsize Distribution,  
 GSDH=Grainsize Distribution+Hydrometer,1-D: One-dimensional Consolidation,CU=Unconsolidated Comp.  
 Mudline elevations determined from leadline measurements and Site tide gage levels

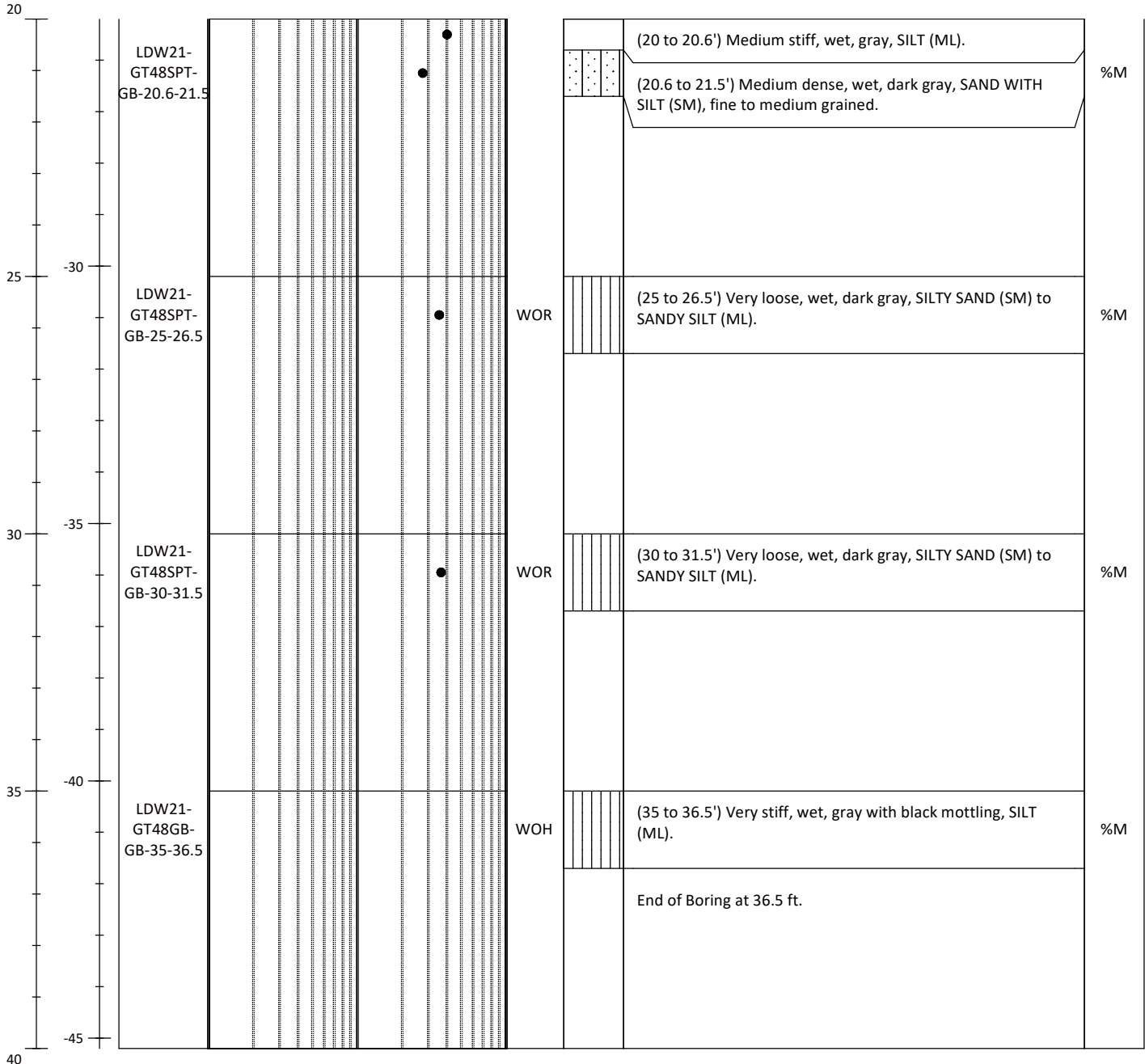
# [DRAFT] Soil Boring Log

## LDW21-GT48-SPT

Sheet 2 of 2

Project #: <b>180067-02.03</b>	Project: <b>LDW Upper Reach Phase 2 Investigation</b>	Method: <b>Rotary Sonic</b>
Location: <b>Seattle, WA</b>	N/LAT: <b>190313.244</b> E/LONG: <b>1278382.172</b>	Total Depth (ft): <b>36.5</b>
Client: <b>Lower Duwamish Waterway Group</b>	Horiz. Datum: <b>Washington State Plane Coordinate North North American Datum of 1983, U.S. Feet</b>	Observed Depth to Mudline (ft): <b>14.0</b>
Collection Date: <b>08.05.21</b>		Mudline Elevation (ft): <b>-5.2</b>
Contractor: <b>Holocene Drilling, Inc</b>	Vert. Datum: <b>Mean Lower Low Water (MLLW)</b>	Hammer: <b>140-lb, 30-in drop, Auto</b>
Logged By: <b>Garrett Timm</b>	Sampler(s): <b>Split Spoon &amp; Shelby Tube Sampler</b>	Hammer Efficiency (%): <b>99</b>

Depth (ft)	Elevation (ft)	Sample ID	Uncorrected Standard Penetration Resistance (blows per foot) and Moisture Content (%)						Other	Lithology	Soil Description Samples and descriptions are in recovered depths. Classification scheme: USCS	Lab Test
			1	2	5	10	20	50				



- ▲ SPT N-Value
- Moisture Content (%)

**Notes:**  
 %M=Percent Moisture Content, SG=Specific Gravity, ATT=Atterberg Limits, GSD=Grainsize Distribution, GSDH=Grainsize Distribution+Hydrometer, 1-D: One-dimensional Consolidation, CU=Unconsolidated Comp.  
 Mudline elevations determined from leadline measurements and Site tide gage levels

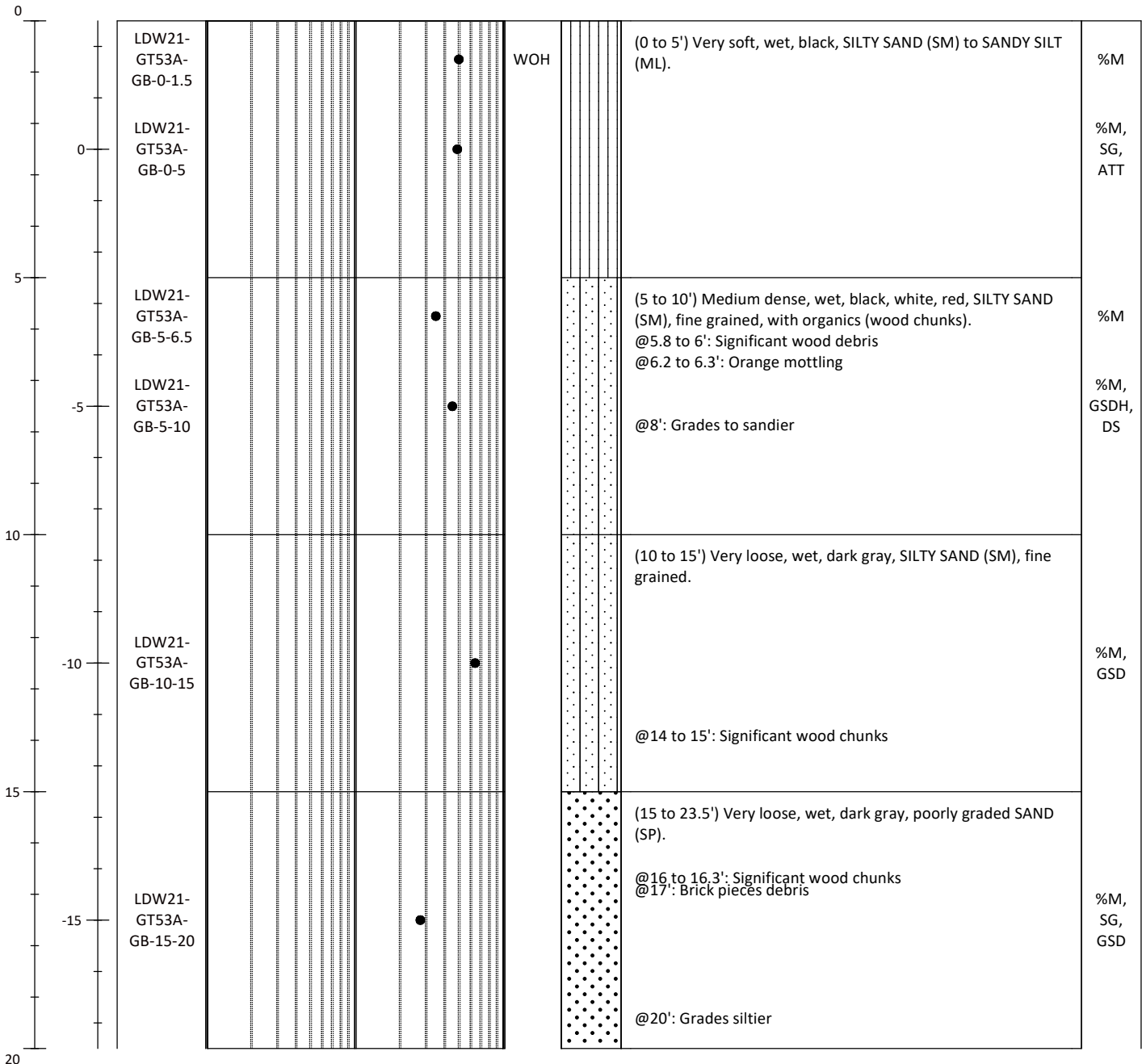
# [DRAFT] Soil Boring Log

## LDW21-GT53-A

Sheet 1 of 2

Project #: <b>180067-02.03</b>	Project: <b>LDW Upper Reach Phase 2 Investigation</b>	Method: <b>Rotary Sonic</b>
Location: <b>Seattle, WA</b>	N/LAT: <b>190178.63</b> E/LONG: <b>1278593.074</b>	Total Depth (ft): <b>30</b>
Client: <b>Lower Duwamish Waterway Group</b>	Horiz. Datum: <b>Washington State Plane Coordinate North North American Datum of 1983, U.S. Feet</b>	Observed Depth to Mudline (ft): <b>2.5</b>
Collection Date: <b>08.05.21</b>		Surface Elevation (ft): <b>2.5</b>
Contractor: <b>Holocene Drilling, Inc</b>	Vert. Datum: <b>Mean Lower Low Water (MLLW)</b>	Hammer: <b>140-lb, 30-in drop, Auto</b>
Logged By: <b>Garrett Timm</b>	Sampler(s): <b>Split Spoon &amp; Shelby Tube Sampler</b>	Hammer Efficiency (%): <b>99</b>

Depth (ft)	Elevation (ft)	Sample ID	Uncorrected Standard Penetration Resistance (blows per foot) and Moisture Content (%)						Other	Lithology	Soil Description Samples and descriptions are in recovered depths. Classification scheme: USCS	Lab Test
			1	2	5	10	20	50				



- ▲ SPT N-Value
- Moisture Content (%)

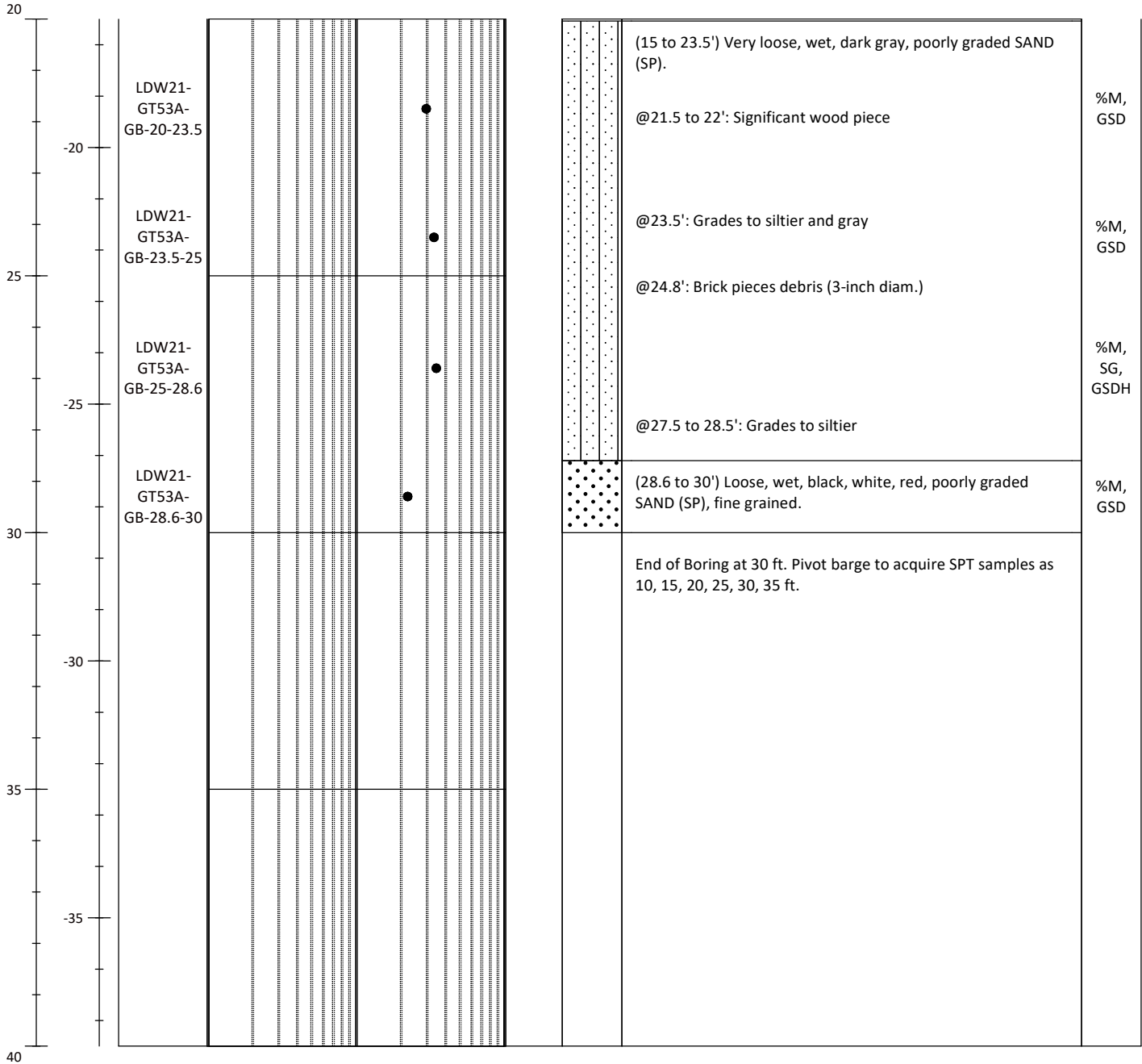
**Notes:**  
 %M=Percent Moisture Content, SG=Specific Gravity, ATT=Atterberg Limits, GSD=Grainsize Distribution, GSDH=Grainsize Distribution+Hydrometer, 1-D: One-dimensional Consolidation, CU=Unconsolidated Comp  
 Elevation estimated using proposed location base map, no depth to mudline reported

# [DRAFT] Soil Boring Log

## LDW21-GT53-A

Project #: <b>180067-02.03</b>	Project: <b>LDW Upper Reach Phase 2 Investigation</b>	Method: <b>Rotary Sonic</b>
Location: <b>Seattle, WA</b>	N/LAT: <b>190178.63</b> E/LONG: <b>1278593.074</b>	Total Depth (ft): <b>30</b>
Client: <b>Lower Duwamish Waterway Group</b>	Horiz. Datum: <b>Washington State Plane Coordinate North North American Datum of 1983, U.S. Feet</b>	Observed Depth to Mudline (ft): <b>2.5</b>
Collection Date: <b>08.05.21</b>		Surface Elevation (ft): <b>2.5</b>
Contractor: <b>Holocene Drilling, Inc</b>	Vert. Datum: <b>Mean Lower Low Water (MLLW)</b>	Hammer: <b>140-lb, 30-in drop, Auto</b>
Logged By: <b>Garrett Timm</b>	Sampler(s): <b>Split Spoon &amp; Shelby Tube Sampler</b>	Hammer Efficiency (%): <b>99</b>

Depth (ft)	Elevation (ft)	Sample ID	Uncorrected Standard Penetration Resistance (blows per foot) and Moisture Content (%)						Other	Lithology	Soil Description Samples and descriptions are in recovered depths. Classification scheme: USCS	Lab Test
			1	2	5	10	20	50				



- ▲ SPT N-Value
- Moisture Content (%)

**Notes:**  
 %M=Percent Moisture Content, SG=Specific Gravity, ATT=Atterberg Limits, GSD=Grainsize Distribution, GSDH=Grainsize Distribution+Hydrometer, 1-D: One-dimensional Consolidation, CU=Unconsolidated Comp  
 Elevation estimated using proposed location base map, no depth to mudline reported

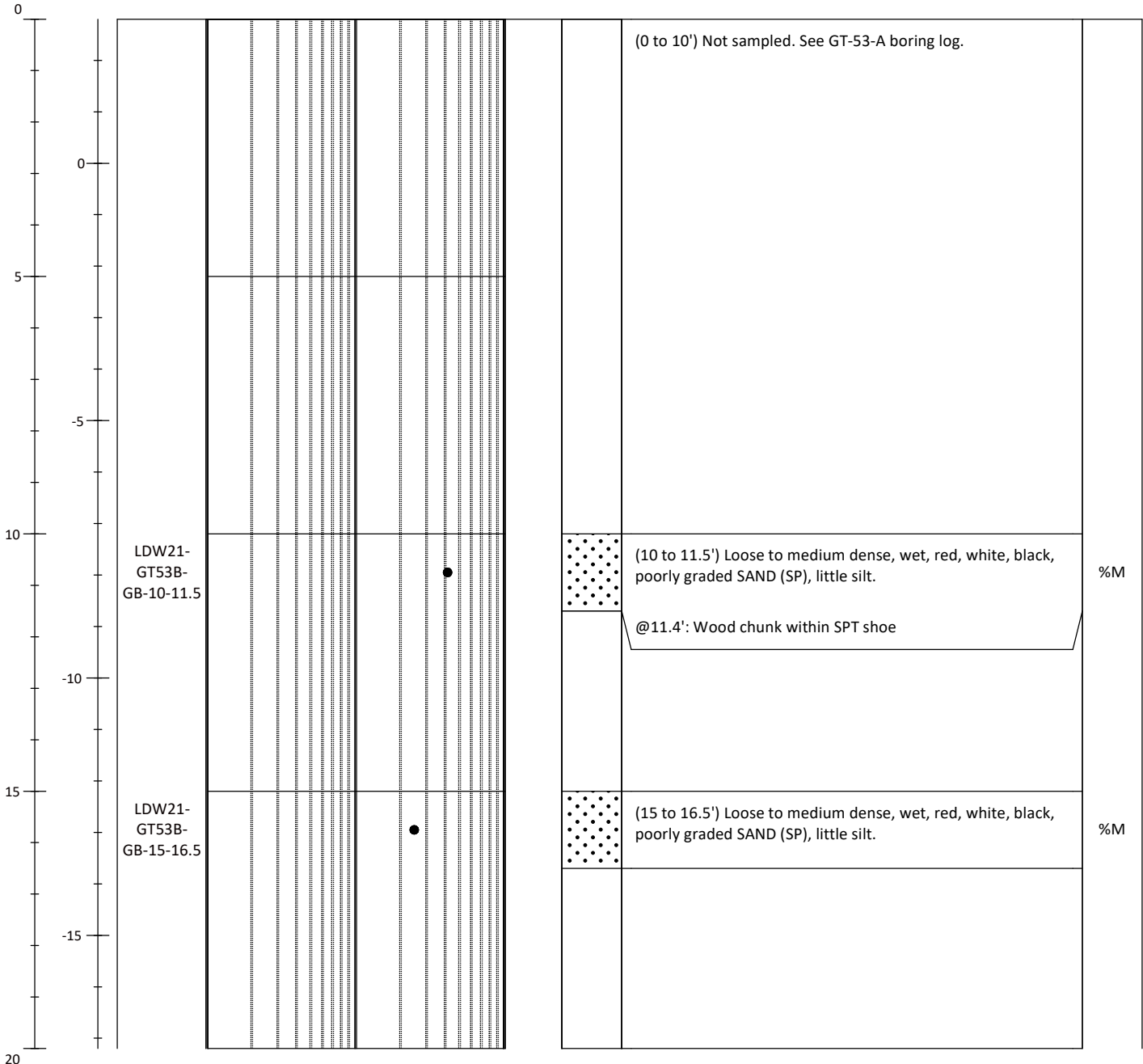
# [DRAFT] Soil Boring Log

## LDW21-GT53-B

Sheet 1 of 2

Project #: <b>180067-02.03</b>	Project: <b>LDW Upper Reach Phase 2 Investigation</b>	Method: <b>Rotary Sonic</b>
Location: <b>Seattle, WA</b>	N/LAT: <b>190175.401</b> E/LONG: <b>1278593.916</b>	Total Depth (ft): <b>32</b>
Client: <b>Lower Duwamish Waterway Group</b>	Horiz. Datum: <b>Washington State Plane Coordinate North North American Datum of 1983, U.S. Feet</b>	Observed Depth to Mudline (ft): <b>9.2</b>
Collection Date: <b>08.05.21</b>		Mudline Elevation (ft): <b>2.8</b>
Contractor: <b>Holocene Drilling, Inc</b>	Vert. Datum: <b>Mean Lower Low Water (MLLW)</b>	Hammer: <b>140-lb, 30-in drop, Auto</b>
Logged By: <b>Garrett Timm</b>	Sampler(s): <b>Split Spoon &amp; Shelby Tube Sampler</b>	Hammer Efficiency (%): <b>99</b>

Depth (ft)	Elevation (ft)	Sample ID	Uncorrected Standard Penetration Resistance (blows per foot) and Moisture Content (%)						Other	Lithology	Soil Description Samples and descriptions are in recovered depths. Classification scheme: USCS	Lab Test
			1	2	5	10	20	50				



- ▲ SPT N-Value
- Moisture Content (%)

**Notes:**  
 %M=Percent Moisture Content, SG=Specific Gravity, ATT=Atterberg Limits, GSD=Grainsize Distribution, GSDH=Grainsize Distribution+Hydrometer, 1-D: One-dimensional Consolidation, CU=Unconsolidated Comp  
 Mudline elevations determined from leadline measurements and Site tide gage levels  
 Depth to mudline at this location determined using reading at LDW21-GT53-A & tide stage difference

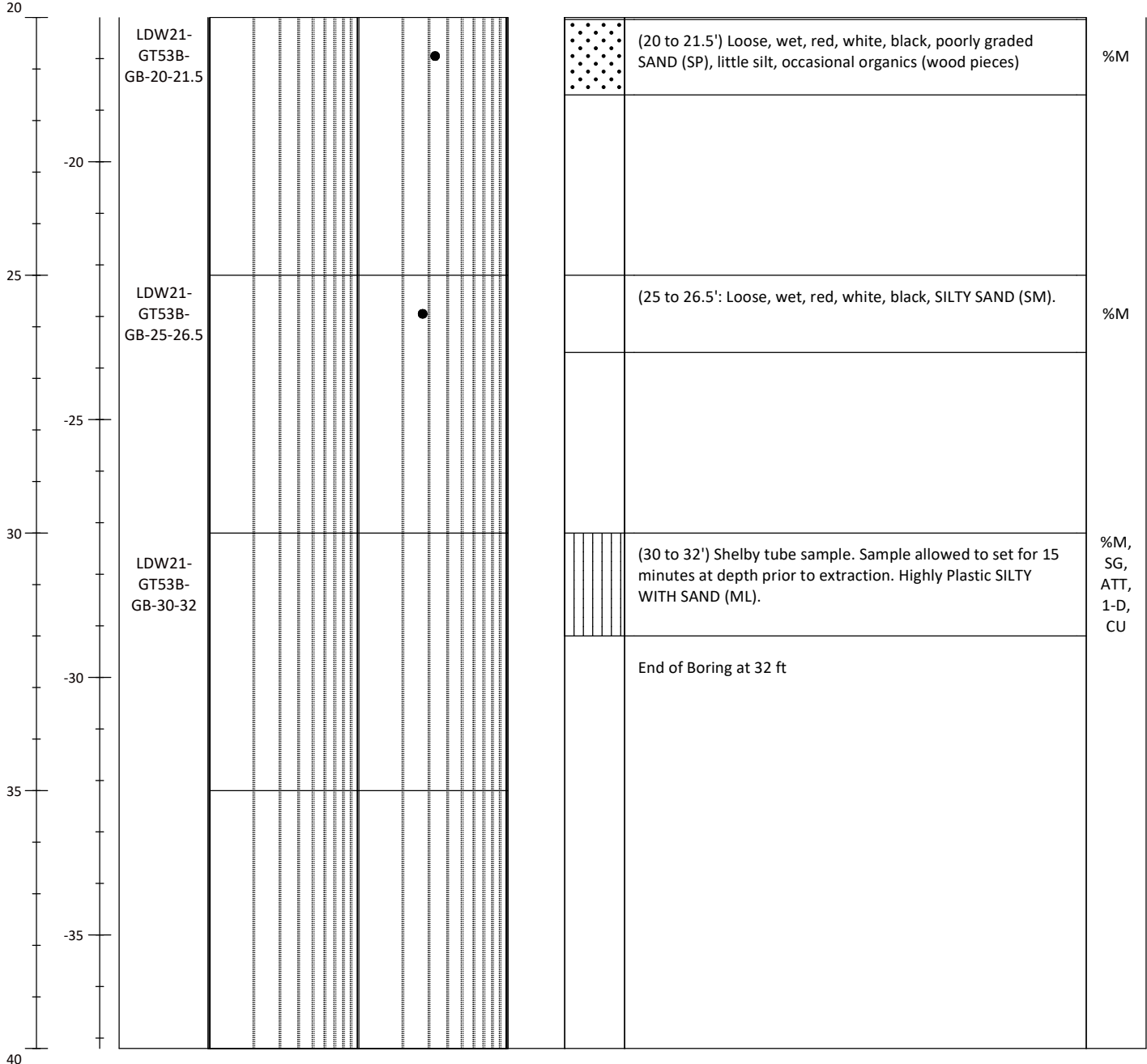
# [DRAFT] Soil Boring Log

## LDW21-GT53-B

Sheet 2 of 2

Project #: <b>180067-02.03</b>		Project: <b>LDW Upper Reach Phase 2 Investigation</b>		Method: <b>Rotary Sonic</b>
Location: <b>Seattle, WA</b>		N/LAT: <b>190175.401</b>	E/LONG: <b>1278593.916</b>	Total Depth (ft): <b>32</b>
Client: <b>Lower Duwamish Waterway Group</b>		Horiz. Datum: <b>Washington State Plane Coordinate North North American Datum of 1983, U.S. Feet</b>		Observed Depth to Mudline (ft): <b>9.2</b>
Collection Date: <b>08.05.21</b>				Mudline Elevation (ft): <b>2.8</b>
Contractor: <b>Holocene Drilling, Inc</b>		Vert. Datum: <b>Mean Lower Low Water (MLLW)</b>		Hammer: <b>140-lb, 30-in drop, Auto</b>
Logged By: <b>Garrett Timm</b>		Sampler(s): <b>Split Spoon &amp; Shelby Tube Sampler</b>		Hammer Efficiency (%): <b>99</b>

Depth (ft)	Elevation (ft)	Sample ID	Uncorrected Standard Penetration Resistance (blows per foot) and Moisture Content (%)						Other	Lithology	Soil Description Samples and descriptions are in recovered depths. Classification scheme: USCS	Lab Test
			1	2	5	10	20	50				



- ▲ SPT N-Value
- Moisture Content (%)

**Notes:**  
 %M=Percent Moisture Content,SG=Specific Gravity,ATT=Atterberg Limits,GSD=Grainsize Distribution, GSDH=Grainsize Distribution+Hydrometer,1-D: One-dimensional Consolidation, CU=Unconsolidated Comp  
 Mudline elevations determined from leadline measurements and Site tide gage levels  
 Depth to mudline at this location determined using reading at LDW21-GT53-A & tide stage difference

# PRESENTATION OF SITE INVESTIGATION RESULTS

## LDW Phase 3

*Prepared for:*

Anchor QEA

ConeTec Job No: 21-59-22445

Project Start Date: 06-JUL-2021

Project End Date: 29-JUL-2021

Report Date: 9-AUG-2021



*Prepared by:*

ConeTec Inc.  
1508 O Street SW, Unit 103-104  
Auburn, WA 98001

Tel: (253) 397-4861

ConeTecWA@conetec.com  
www.conetec.com  
www.conetecdataservices.com



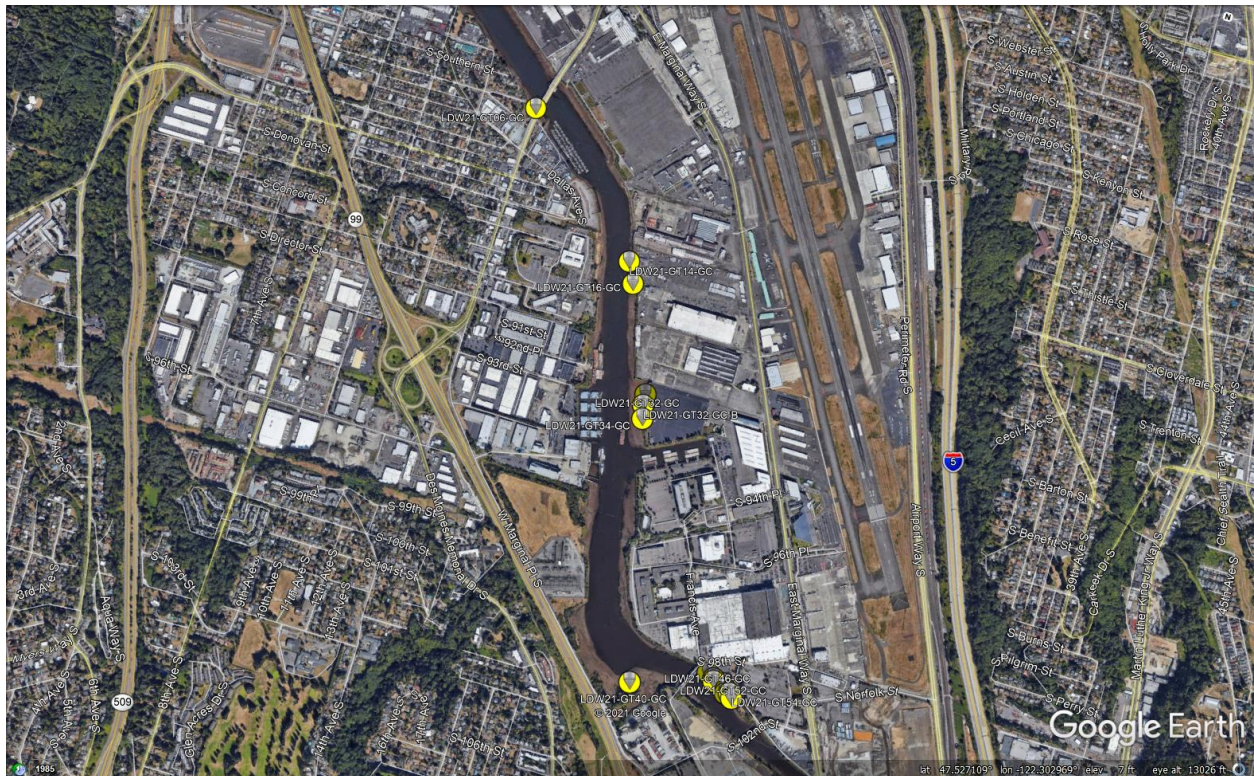
Introduction

The enclosed report presents the results of the site investigation program conducted by ConeTec Inc. for Anchor QEA along mile 3-5 of the Duwamish River located in Seattle WA. The program consisted of cone penetration tests, full flow penetration tests & electronic vane testing

Project Information

Project	
Client	Anchor QEA
Project	LDW Phase 3
ConeTec project number	21-59-22445

An aerial overview from Google Earth including the CPTu test locations is presented below.



Rig Description	Deployment System	Test Type
C05-023 Track Rig	Integrated Push System	CPT, BCPT, VST
A07-018 Amphibious Rig	Integrated Push System	CPT
Barge Support	Auxiliary Push Boat	CPT, BCPT, VST



Coordinates			
Test Type	Collection Method	EPSG Number	Comments
CPT, BCPT, VST	Client provided	4326	Coordinates converted from State Plane

Cone Penetrometers Used for this Project						
Cone Description	Cone Number	Cross Sectional Area (cm <sup>2</sup> )	Sleeve Area (cm <sup>2</sup> )	Tip Capacity (bar)	Sleeve Capacity (bar)	Pore Pressure Capacity (bar)
681:T375F10U35	681	15	225	375	10	35
Cone 681 was used for all CPTu soundings.						

Cone Penetration Test (CPTu)	
Depth reference	Depths are referenced to the existing mudline at the time of each test.
Tip and sleeve data offset	0.1 meter This has been accounted for in the CPT data files.
Additional plots	<ul style="list-style-type: none"> <li>Advanced plots with <math>I_c</math>, <math>S_u</math>, <math>\phi</math> and <math>N1(60)</math></li> <li>Soil Behaviour Type (SBT) scatter plots</li> </ul>
Additional comments	A negative water table has been applied to all soundings completed from barge deck. All CPT data files begin at mudline (mudline = 0.0ft)

Calculated Geotechnical Parameter Tables	
Additional information	<p>The Normalized Soil Behaviour Type Chart based on <math>Q_{tn}</math> (SBT <math>Q_{tn}</math>) (Robertson, 2009) was used to classify the soil for this project. A detailed set of calculated CPTu parameters have been generated and are provided in Excel format files in the release folder. The CPTu parameter calculations are based on values of corrected tip resistance (<math>q_t</math>) sleeve friction (<math>f_s</math>) and pore pressure (<math>u_2</math>).</p> <p>Effective stresses are calculated based on unit weights that have been assigned to the individual soil behaviour type zones and the assumed equilibrium pore pressure profile.</p>

Full-Flow Cone Penetration Test (BCPTu)	
Depth reference	All soundings were started slightly above the mudline in the water column. Mudline is clearly indicated on all plots and clearly visible within the data set.
Unit weight profiles	<ul style="list-style-type: none"> <li>A unit weight of 62.43pcf was applied to data collected within the water column above mudline</li> <li>A unit weight of 111.37pcf was applied to data collected below mudline</li> </ul> <p>The unit weight is clearly indicated in the data set.</p>

Electric Field Vane Shear Test (VST)	
Depth reference	Depths are referenced to depth below mudline at the time of each test
Load cell capacity	100 N·m
Load cell location	Uphole
Additional comments	All vane tests were completed from the floating barge platform. The vane test results were affected by barge movement from local waves, local vessel traffic and river flow. Additionally, the vane results were susceptible to elevation change from either rising or falling tide. Over the course of a vane test the barge would gain/lose approximately 2"-4" of elevation due to tidal effects.

### Limitations

This report has been prepared for the exclusive use of Anchor QEA (Client) for the project titled "LDW Phase 3". The report's contents may not be relied upon by any other party without the express written permission of ConeTec Inc. (ConeTec). ConeTec has provided site investigation services, prepared the factual data reporting and provided geotechnical parameter calculations consistent with current best practices. No other warranty, expressed or implied, is made.

The information presented in the report document and the accompanying data set pertain to the specific project, site conditions and objectives described to ConeTec by the Client. In order to properly understand the factual data, assumptions and calculations, reference must be made to the documents provided and their accompanying data sets, in their entirety.

Cone penetration tests (CPTu) are conducted using an integrated electronic piezocone penetrometer and data acquisition system manufactured by Adara Systems Ltd., a subsidiary of ConeTec.

ConeTec's piezocone penetrometers are compression type designs in which the tip and friction sleeve load cells are independent and have separate load capacities. The piezocones use strain gauged load cells for tip and sleeve friction and a strain gauged diaphragm type transducer for recording pore pressure. The piezocones also have a platinum resistive temperature device (RTD) for monitoring the temperature of the sensors, an accelerometer type dual axis inclinometer and two geophone sensors for recording seismic signals. All signals are amplified and measured with minimum sixteen-bit resolution down hole within the cone body, and the signals are sent to the surface using a high bandwidth, error corrected digital interface through a shielded cable.

ConeTec penetrometers are manufactured with various tip, friction and pore pressure capacities in both 10 cm<sup>2</sup> and 15 cm<sup>2</sup> tip base area configurations in order to maximize signal resolution for various soil conditions. The specific piezocone used for each test is described in the CPT summary table presented in the first appendix. The 15 cm<sup>2</sup> penetrometers do not require friction reducers as they have a diameter larger than the deployment rods. The 10 cm<sup>2</sup> piezocones use a friction reducer consisting of a rod adapter extension behind the main cone body with an enlarged cross sectional area (typically 44 millimeters diameter over a length of 32 millimeters with tapered leading and trailing edges) located at a distance of 585 millimeters above the cone tip.

The penetrometers are designed with equal end area friction sleeves, a net end area ratio of 0.8 and cone tips with a 60 degree apex angle.

All ConeTec piezocones can record pore pressure at various locations. Unless otherwise noted, the pore pressure filter is located directly behind the cone tip in the "u<sub>2</sub>" position ([ASTM Type 2](#)). The filter is six millimeters thick, made of porous plastic (polyethylene) having an average pore size of 125 microns (90-160 microns). The function of the filter is to allow rapid movements of extremely small volumes of water needed to activate the pressure transducer while preventing soil ingress or blockage.

The piezocone penetrometers are manufactured with dimensions, tolerances and sensor characteristics that are in general accordance with the current [ASTM D5778](#) standard. ConeTec's calibration criteria also meets or exceeds those of the current [ASTM D5778](#) standard. An illustration of the piezocone penetrometer is presented in [Figure CPTu](#).

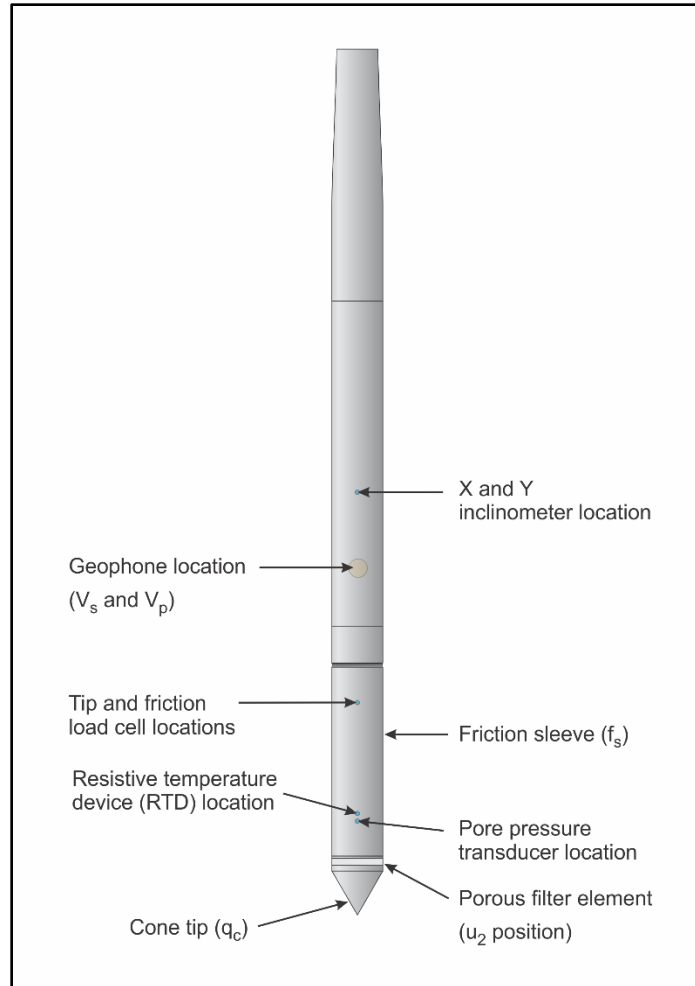


Figure CPTu. Piezocone Penetrometer (15 cm<sup>2</sup>)

The ConeTec data acquisition systems consist of a Windows based computer and a signal interface box and power supply. The signal interface combines depth increment signals, seismic trigger signals and the downhole digital data. This combined data is then sent to the Windows based computer for collection and presentation. The data is recorded at fixed depth increments using a depth wheel attached to the push cylinders or by using a spring loaded rubber depth wheel that is held against the cone rods. The typical recording interval is 2.5 centimeters; custom recording intervals are possible.

The system displays the CPTu data in real time and records the following parameters to a storage media during penetration:

- Depth
- Uncorrected tip resistance ( $q_c$ )
- Sleeve friction ( $f_s$ )
- Dynamic pore pressure ( $u$ )
- Additional sensors such as resistivity, passive gamma, ultra violet induced fluorescence, if applicable

All testing is performed in accordance to ConeTec's CPTu operating procedures which are in general accordance with the current [ASTM D5778](#) standard.

Prior to the start of a CPTu sounding a suitable cone is selected, the cone and data acquisition system are powered on, the pore pressure system is saturated with silicone oil and the baseline readings are recorded with the cone hanging freely in a vertical position.

The CPTu is conducted at a steady rate of two centimeters per second, within acceptable tolerances. Typically one meter length rods with an outer diameter of 1.5 inches (38.1 millimeters) are added to advance the cone to the sounding termination depth. After cone retraction final baselines are recorded.

Additional information pertaining to ConeTec's cone penetration testing procedures:

- Each filter is saturated in silicone oil under vacuum pressure prior to use
- Baseline readings are compared to previous readings
- Soundings are terminated at the client's target depth or at a depth where an obstruction is encountered, excessive rod flex occurs, excessive inclination occurs, equipment damage is likely to take place, or a dangerous working environment arises
- Differences between initial and final baselines are calculated to ensure zero load offsets have not occurred and to ensure compliance with [ASTM](#) standards

The interpretation of piezocone data for this report is based on the corrected tip resistance ( $q_t$ ), sleeve friction ( $f_s$ ) and pore water pressure ( $u$ ). The interpretation of soil type is based on the correlations developed by [Robertson et al. \(1986\)](#) and [Robertson \(1990, 2009\)](#). It should be noted that it is not always possible to accurately identify a soil behavior type based on these parameters. In these situations, experience, judgment and an assessment of other parameters may be used to infer soil behavior type.

The recorded tip resistance ( $q_c$ ) is the total force acting on the piezocone tip divided by its base area. The tip resistance is corrected for pore pressure effects and termed corrected tip resistance ( $q_t$ ) according to the following expression presented in [Robertson et al. \(1986\)](#):

$$q_t = q_c + (1-a) \cdot u_2$$

where:  $q_t$  is the corrected tip resistance

$q_c$  is the recorded tip resistance

$u_2$  is the recorded dynamic pore pressure behind the tip ( $u_2$  position)

$a$  is the Net Area Ratio for the piezocone (0.8 for ConeTec probes)

The sleeve friction ( $f_s$ ) is the frictional force on the sleeve divided by its surface area. As all ConeTec piezocones have equal end area friction sleeves, pore pressure corrections to the sleeve data are not required.

The dynamic pore pressure ( $u$ ) is a measure of the pore pressures generated during cone penetration. To record equilibrium pore pressure, the penetration must be stopped to allow the dynamic pore pressures to stabilize. The rate at which this occurs is predominantly a function of the permeability of the soil and the diameter of the cone.

The friction ratio ( $R_f$ ) is a calculated parameter. It is defined as the ratio of sleeve friction to the tip resistance expressed as a percentage. Generally, saturated cohesive soils have low tip resistance, high friction ratios and generate large excess pore water pressures. Cohesionless soils have higher tip resistances, lower friction ratios and do not generate significant excess pore water pressure.

A summary of the CPTu soundings along with test details and individual plots are provided in the appendices. A set of files with calculated geotechnical parameters were generated for each sounding based on published correlations and are provided in Excel format in the data release folder. Information regarding the methods used is also included in the data release folder.

For additional information on CPTu interpretations and calculated geotechnical parameters, refer to [Robertson et al. \(1986\)](#), [Lunne et al. \(1997\)](#), [Robertson \(2009\)](#), [Mayne \(2013, 2014\)](#) and [Mayne and Peuchen \(2012\)](#).

The cone penetration test is halted at specific depths to carry out pore pressure dissipation (PPD) tests, shown in Figure PPD-1. For each dissipation test the cone and rods are decoupled from the rig and the data acquisition system measures and records the variation of the pore pressure ( $u$ ) with time ( $t$ ).

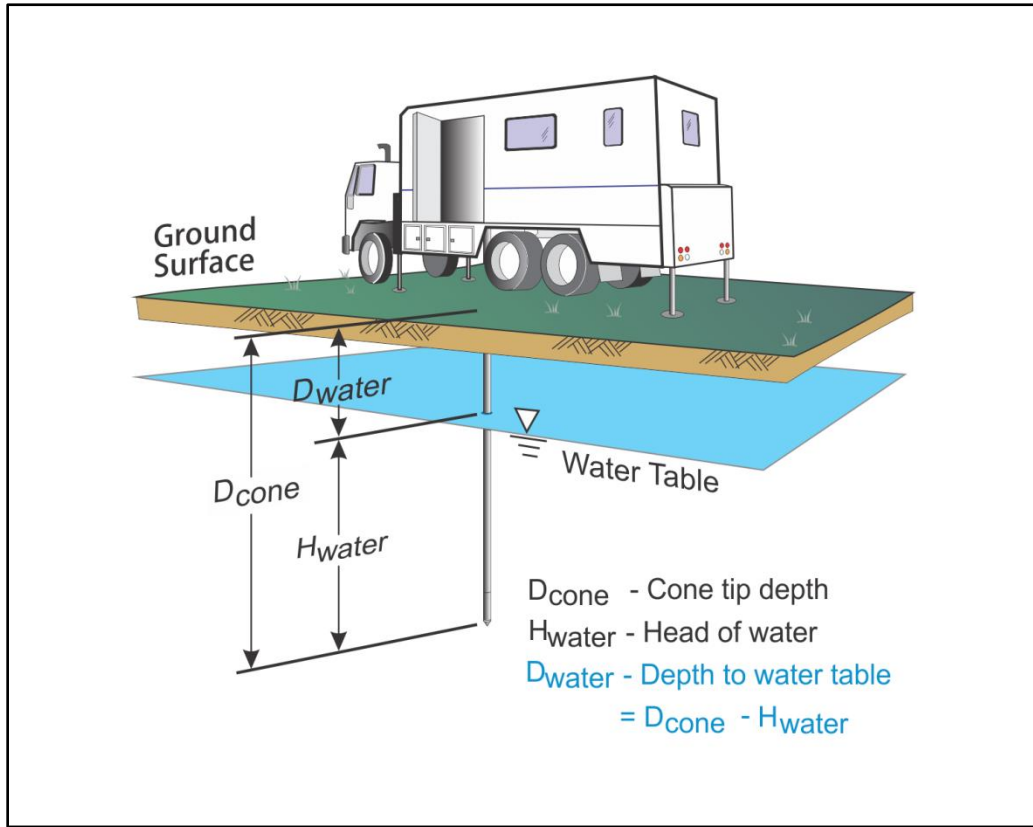


Figure PPD-1. Pore pressure dissipation test setup

Pore pressure dissipation data can be interpreted to provide estimates of ground water conditions, permeability, consolidation characteristics and soil behavior.

The typical shapes of dissipation curves shown in Figure PPD-2 are very useful in assessing soil type, drainage, in situ pore pressure and soil properties. A flat curve that stabilizes quickly is typical of a freely draining sand. Undrained soils such as clays will typically show positive excess pore pressure and have long dissipation times. Dilative soils will often exhibit dynamic pore pressures below equilibrium that then rise over time. Overconsolidated fine-grained soils will often exhibit an initial dilatory response where there is an initial rise in pore pressure before reaching a peak and dissipating.

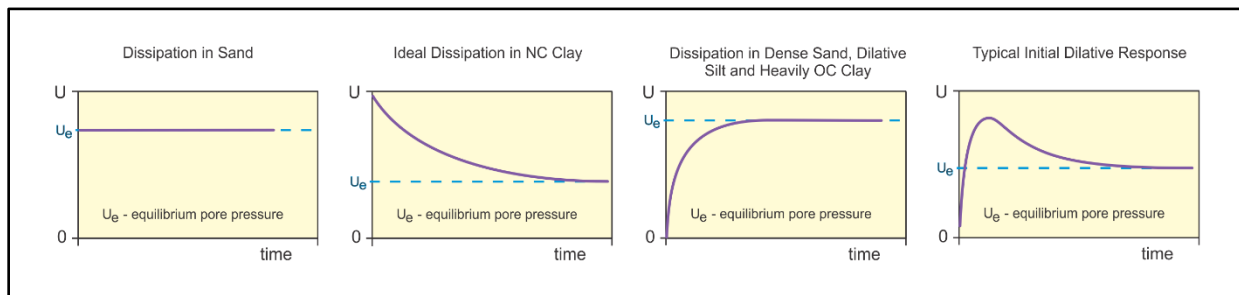


Figure PPD-2. Pore pressure dissipation curve examples

In order to interpret the equilibrium pore pressure ( $u_{eq}$ ) and the apparent phreatic surface, the pore pressure should be monitored until such time as there is no variation in pore pressure with time as shown for each curve in [Figure PPD-2](#).

In fine grained deposits the point at which 100% of the excess pore pressure has dissipated is known as  $t_{100}$ . In some cases this can take an excessive amount of time and it may be impractical to take the dissipation to  $t_{100}$ . A theoretical analysis of pore pressure dissipations by [Teh and Houlsby \(1991\)](#) showed that a single curve relating degree of dissipation versus theoretical time factor ( $T^*$ ) may be used to calculate the coefficient of consolidation ( $c_h$ ) at various degrees of dissipation resulting in the expression for  $c_h$  shown below.

$$c_h = \frac{T^* \cdot a^2 \cdot \sqrt{l_r}}{t}$$

Where:

- $T^*$  is the dimensionless time factor ([Table Time Factor](#))
- $a$  is the radius of the cone
- $l_r$  is the rigidity index
- $t$  is the time at the degree of consolidation

Table Time Factor.  $T^*$  versus degree of dissipation ([Teh and Houlsby \(1991\)](#))

Degree of Dissipation (%)	20	30	40	50	60	70	80
$T^* (u_2)$	0.038	0.078	0.142	0.245	0.439	0.804	1.60

The coefficient of consolidation is typically analyzed using the time ( $t_{50}$ ) corresponding to a degree of dissipation of 50% ( $u_{50}$ ). In order to determine  $t_{50}$ , dissipation tests must be taken to a pressure less than  $u_{50}$ . The  $u_{50}$  value is half way between the initial maximum pore pressure and the equilibrium pore pressure value, known as  $u_{100}$ . To estimate  $u_{50}$ , both the initial maximum pore pressure and  $u_{100}$  must be known or estimated. Other degrees of dissipations may be considered, particularly for extremely long dissipations.

At any specific degree of dissipation the equilibrium pore pressure ( $u$  at  $t_{100}$ ) must be estimated at the depth of interest. The equilibrium value may be determined from one or more sources such as measuring the value directly ( $u_{100}$ ), estimating it from other dissipations in the same profile, estimating the phreatic surface and assuming hydrostatic conditions, from nearby soundings, from client provided information, from site observations and/or past experience, or from other site instrumentation.

For calculations of  $c_h$  ([Teh and Houlsby \(1991\)](#)),  $t_{50}$  values are estimated from the corresponding pore pressure dissipation curve and a rigidity index ( $l_r$ ) is assumed. For curves having an initial dilatatory response in which an initial rise in pore pressure occurs before reaching a peak, the relative time from the peak value is used in determining  $t_{50}$ . In cases where the time to peak is excessive,  $t_{50}$  values are not calculated.

Due to possible inherent uncertainties in estimating  $l_r$ , the equilibrium pore pressure and the effect of an initial dilatatory response on calculating  $t_{50}$ , other methods should be applied to confirm the results for  $c_h$ .



Additional published methods for estimating the coefficient of consolidation from a piezocone test are described in Burns and Mayne (1998, 2002), Jones and Van Zyl (1981), Robertson et al. (1992) and Sully et al. (1999).

A summary of the pore pressure dissipation tests and dissipation plots are presented in the relevant appendix.

## REFERENCES

---

- ASTM D5778-12, 2012, "Standard Test Method for Performing Electronic Friction Cone and Piezocone Penetration Testing of Soils", ASTM International, West Conshohocken, PA. DOI: [10.1520/D5778-12](https://doi.org/10.1520/D5778-12).
- Burns, S.E. and Mayne, P.W., 1998, "Monotonic and dilatatory pore pressure decay during piezocone tests", Canadian Geotechnical Journal 26 (4): 1063-1073. DOI: [1063-1073/T98-062](https://doi.org/10.1063-1073/T98-062).
- Burns, S.E. and Mayne, P.W., 2002, "Analytical cavity expansion-critical state model cone dissipation in fine-grained soils", Soils & Foundations, Vol. 42(2): 131-137.
- Jones, G.A. and Van Zyl, D.J.A., 1981, "The piezometer probe: a useful investigation tool", Proceedings, 10<sup>th</sup> International Conference on Soil Mechanics and Foundation Engineering, Vol. 3, Stockholm: 489-495.
- Lunne, T., Robertson, P.K. and Powell, J. J. M., 1997, "Cone Penetration Testing in Geotechnical Practice", Blackie Academic and Professional.
- Mayne, P.W., 2013, "Evaluating yield stress of soils from laboratory consolidation and in-situ cone penetration tests", Sound Geotechnical Research to Practice (Holtz Volume) GSP 230, ASCE, Reston/VA: 406-420. DOI: [10.1061/9780784412770.027](https://doi.org/10.1061/9780784412770.027).
- Mayne, P.W. and Peuchen, J., 2012, "Unit weight trends with cone resistance in soft to firm clays", Geotechnical and Geophysical Site Characterization 4, Vol. 1 (Proc. ISC-4, Pernambuco), CRC Press, London: 903-910.
- Mayne, P.W., 2014, "Interpretation of geotechnical parameters from seismic piezocone tests", CPT'14 Keynote Address, Las Vegas, NV, May 2014.
- Robertson, P.K., Campanella, R.G., Gillespie, D. and Greig, J., 1986, "Use of Piezometer Cone Data", Proceedings of InSitu 86, ASCE Specialty Conference, Blacksburg, Virginia.
- Robertson, P.K., 1990, "Soil Classification Using the Cone Penetration Test", Canadian Geotechnical Journal, Volume 27: 151-158. DOI: [10.1139/T90-014](https://doi.org/10.1139/T90-014).
- Robertson, P.K., Sully, J.P., Woeller, D.J., Lunne, T., Powell, J.J.M. and Gillespie, D.G., 1992, "Estimating coefficient of consolidation from piezocone tests", Canadian Geotechnical Journal, 29(4): 539-550. DOI: [10.1139/T92-061](https://doi.org/10.1139/T92-061).
- Robertson, P.K., 2009, "Interpretation of cone penetration tests – a unified approach", Canadian Geotechnical Journal, Volume 46: 1337-1355. DOI: [10.1139/T09-065](https://doi.org/10.1139/T09-065).
- Sully, J.P., Robertson, P.K., Campanella, R.G. and Woeller, D.J., 1999, "An approach to evaluation of field CPTU dissipation data in overconsolidated fine-grained soils", Canadian Geotechnical Journal, 36(2): 369-381. DOI: [10.1139/T98-105](https://doi.org/10.1139/T98-105).
- Teh, C.I., and Houlsby, G.T., 1991, "An analytical study of the cone penetration test in clay", Geotechnique, 41(1): 17-34. DOI: [10.1680/geot.1991.41.1.17](https://doi.org/10.1680/geot.1991.41.1.17).

Full flow penetration testing (BCPTu) is performed in conjunction with a piezocone penetration test using an integrated electronic piezocone with a spherical attachment and a data acquisition system manufactured by Adara Systems Ltd., a subsidiary of ConeTec.

ConeTec's piezocone penetrometers are compression type designs in which the tip and friction sleeve load cells are independent and have separate load capacities. The piezocones use strain gauged load cells for tip and sleeve friction and a strain gauged diaphragm type transducer for recording pore pressure. The piezocones also have a platinum resistive temperature device (RTD) for monitoring the temperature of the sensors, an accelerometer type dual axis inclinometer and a geophone sensor for recording seismic signals. All signals are amplified downhole within the cone body and the analog signals are sent to the surface through a shielded cable.

ConeTec penetrometers are manufactured with various tip, friction and pore pressure capacities in 5 cm<sup>2</sup>, 10 cm<sup>2</sup> and 15 cm<sup>2</sup> tip base area configurations in order to maximize signal resolution for various soil conditions. The 15 cm<sup>2</sup> penetrometers do not require friction reducers as they have a diameter larger than the deployment rods. The 5 cm<sup>2</sup> and 10 cm<sup>2</sup> piezocones use a friction reducer consisting of a rod adapter extension behind the main cone body with an enlarged cross-sectional area (typically forty-four millimeter diameter over a length of thirty-two millimeters with tapered leading and trailing edges) located at a distance of 585 millimeters above the cone tip.

The penetrometers are designed with equal end area friction sleeves, a net end area ratio of 0.8 and cone tips with a sixty-degree apex angle.

The piezocone penetrometers are manufactured with dimensions, tolerances and sensor characteristics that are in general accordance with the current [ASTM D5778](#) standard. ConeTec's calibration criteria also meet or exceed those of the current [ASTM D5778](#) standard.

For ball full flow penetration tests, the cone tip is replaced with a spherical attachment that can have projected plan areas of 40 cm<sup>2</sup>, 60 cm<sup>2</sup>, 100 cm<sup>2</sup> or 150 cm<sup>2</sup>. The selection of the size is based on soil strength and deployment limitations. An illustration of the piezocone with a spherical attachment is presented in [Figure BCPTu](#).

The specific piezocone and ball area used for each test is described in the ball full flow penetration test summary presented in the relevant appendix.

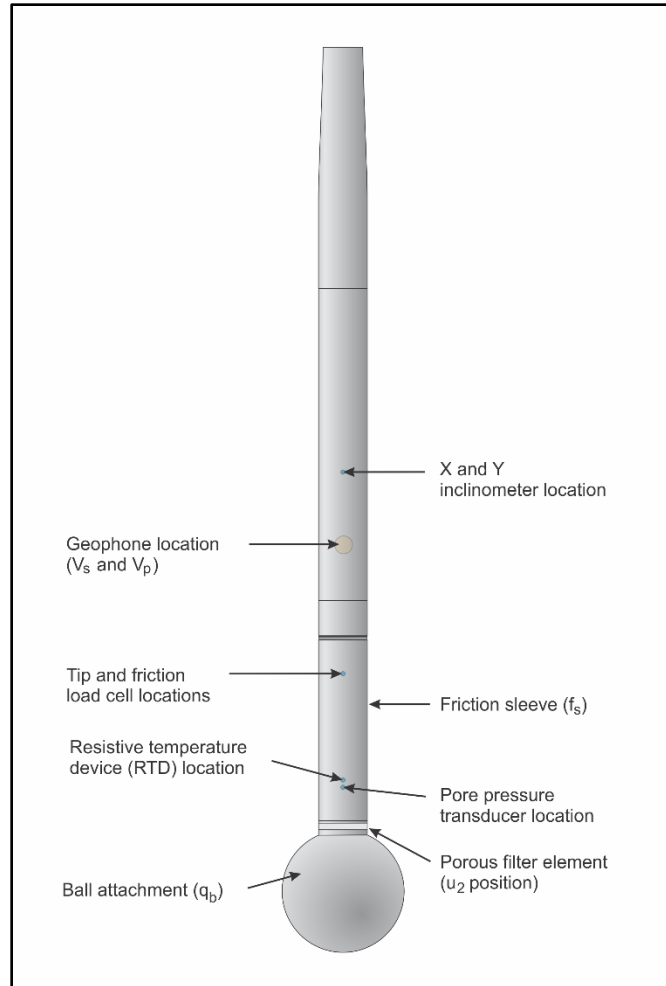


Figure BCPTu. Piezocone penetrometer with a spherical attachment

The ConeTec data acquisition systems consist of a Windows based computer and a signal conditioner and power supply interface box with a sixteen-bit (or greater) analog to digital (A/D) converter. The data is recorded in fixed depth increments using a depth wheel attached to the push cylinders or by using a spring loaded rubber depth wheel that is held against the cone rods. The typical recording interval is 2.5 centimeters; custom recording intervals are possible.

The system displays the data in real time and records the following parameters to a storage media during penetration:

- Depth
- Uncorrected ball tip resistance ( $q_b$ )
- Sleeve friction ( $f_s$ )
- Dynamic pore pressure ( $u$ ) at the shoulder ( $u_2$ ) or at the equator of the ball
- Additional sensors such as resistivity, passive gamma, ultra violet induced fluorescence, if applicable

Prior to the start of a BCPTu sounding a suitable cone and spherical attachment are selected, the cone and data acquisition system are powered on, the pore pressure system is saturated with silicone oil and the baseline readings are recorded with the ball hanging freely in a vertical position.

The BCPTu is conducted at a steady rate of two centimeters per second, within acceptable tolerances. Typically, one-meter length rods with an outer diameter of 38.1 millimeters are added to advance the ball to the sounding termination depth. The test may be interrupted at selected depths to cycle the probe up and down in order to achieve a completely remolded soil state. Cycling is typically conducted during retraction of the ball and the number of conducted cycles is dependent on reaching a consistent tip value. After ball retraction the final baselines are recorded.

The full flow penetration test can be halted at specific depths to carry out pore pressure dissipation (PPD) tests. For each dissipation test the data acquisition system measures and records the variation of the pore pressure ( $u$ ) with time ( $t$ ). Pore pressure dissipation data can be interpreted to provide estimates of equilibrium pore pressures ( $u_{eq}$ ).

Additional information pertaining to ConeTec's full flow penetration testing procedures:

- Each filter is saturated in silicone oil under vacuum pressure prior to use
- Recorded baselines are checked with an independent multi-meter
- Baseline readings are compared to previous readings verifying compliance with [ASTM](#) standards
- Soundings are terminated at the client's target depth or at a depth where an obstruction is encountered, excessive rod flex occurs or excessive inclination occurs, equipment damage is likely to take place or a dangerous working environment arises
- Differences between initial and final baselines are calculated to ensure zero load offsets have not occurred and to ensure compliance with [ASTM](#) standards

Full flow penetration tests are conducted to assess the undrained shear strength ( $S_u$ ) of low to medium strength soils. During penetration, the soil flows around the penetrometer significantly reducing the influence of overburden stress as compared to the cone penetration test (CPTu). For the test to be valid, the soil must flow around the penetrometer. Cycling is conducted in order to achieve a completely remolded soil state to provide an indication of sensitivity in soft soils.

The recorded ball tip resistance ( $q_b$ ) is the total force acting on the piezocone spherical attachment divided by its base area. The ball tip resistance is corrected for pore pressure effects and termed corrected ball tip resistance ( $q_{bt}$ ) according to the following expression:

$$q_{bt} = q_b + [(1-a)u_2] \frac{A_s}{A_p}$$

where:  $q_{bt}$  is the corrected ball tip resistance

$q_b$  is the recorded ball tip resistance

$u_2$  is the recorded dynamic pore pressure behind the tip ( $u_2$  position)

$a$  is the Net Area Ratio for the piezocone (0.8 for ConeTec probes)

$A_s$  is the shaft area

$A_p$  is the ball plan area

The undrained shear strength ( $S_u$ ) derived from the full flow penetration test is related to the net ball tip resistance ( $q_{bt\text{net}}$ ) and ball factor ( $N_{\text{ball}}$ ) using the following relationship:

$$S_u = \frac{q_{bt\text{net}}}{N_{\text{ball}}}$$

Due to different geometry and the subdued sleeve and pore pressure response, full flow penetration test results are not used for the interpretation of other geotechnical parameters or for soil classification.

A summary of the BCPTu soundings along with test details and individual plots are provided in the appendices. Tabular results generated for each sounding are provided in Excel format in the data release folder. Information regarding the calculated parameters is also included in the data release folder.

For additional information on full flow penetrometer testing, refer to [Weemees et al. \(2006\)](#).

### References

ASTM D5778-12, 2012, "Standard Test Method for Performing Electronic Friction Cone and Piezocone Penetration Testing of Soils", ASTM International, West Conshohocken, PA. DOI: [10.1520/D5778-12](#).

Weemees, I., Howie, J., Woeller, D.J., Sharp, J.T., Cargill, E., Greig, J., 2006, "Improved Techniques for the In-Situ Determination of Undrained Shear Strength in Soft Clays," Sea to Sky Geotechnics, Proceedings of the 59th Canadian Geotechnical Conference, Vancouver, B.C., 1–4 October. BiTech Publishers Ltd., Richmond, B.C. pp. 89–95.

The electric field vane system is manufactured by Adara Systems Ltd., a subsidiary of ConeTec. An illustration of the uphole vane system configuration is presented in [Figure eVST](#).

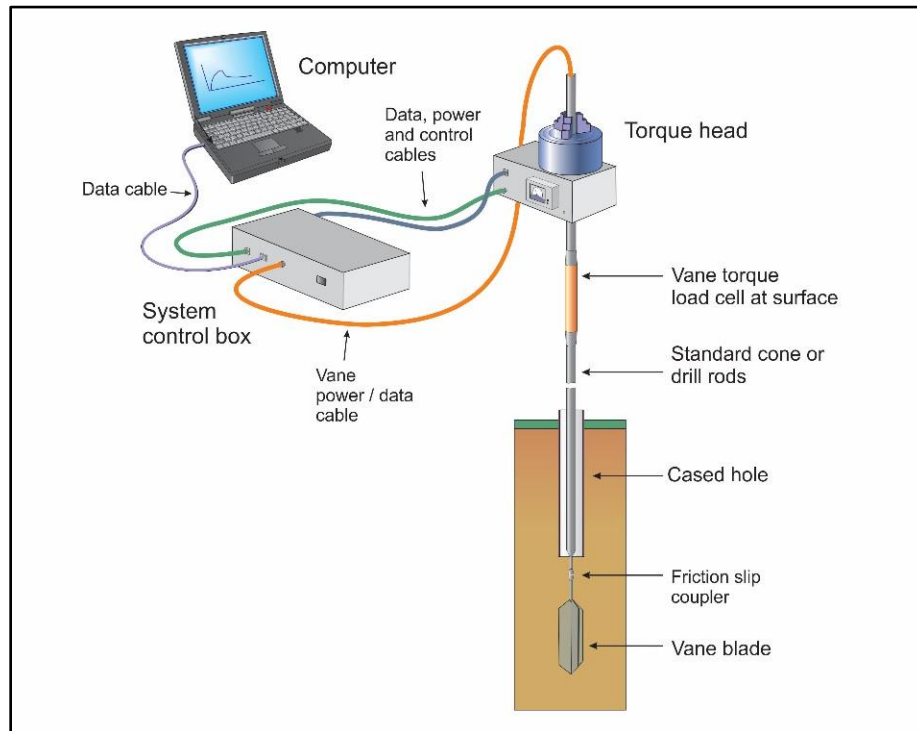


Figure eVST. Illustration of the uphole electric field vane system configuration

The vane system is designed with an array of strain gauges in a load cell that measure the applied torque. The torque signal is amplified and converted to digital data within the tool and transmitted to the data acquisition system through a shielded cable. The system uses a friction slip coupler to permit the free slip or play of approximately fifteen degrees between the rods and the vane blade in order to isolate and record rod friction from the soil before rotation of the vane blade starts. The system is designed to use vane blades of various sizes and configurations that connect to the friction slip coupler. The vane blades manufactured by Adara have dimensions and tolerances that are in general accordance with the current [ASTM D2573](#) standards. In very soft soil conditions and at the request of the client, ConeTec may use a large diameter vane blade that exceeds the [ASTM D2573](#) maximum size specifications in order to maximize torque resolution. In very stiff soil conditions and at the request of the client, ConeTec may use a smaller diameter vane blade than the minimum size specified in [ASTM D2573](#) in order to obtain a peak torque below the capacity of the load cell.

The electric motor (capable of 100 Newton-meters of torque) is designed to clamp onto and rotate the rods and vane blade at a constant rate.

ConeTec's calibration criteria of the load cells are in accordance with the current [ASTM D2573](#) standard.

The data acquisition system consists of a computer that records the vane data every 0.2 degrees of rotation. The system records the following parameters and saves them to a file as the test is conducted:

- Torque in Newton-meters
- Rotation in degrees
- Elapsed time in seconds (from the start of the test)

All testing is performed in accordance to ConeTec’s field vane testing operating procedures and in general accordance with the current [ASTM D2573](#) standard. For additional information on vane shear testing refer to [Greig et al. \(1987\)](#).

Prior to the start of a vane shear test profile, a suitable sized vane blade is selected, the vane system is powered on and the vane load cell baseline reading is recorded with the load cell hanging freely in a vertical position.

The vane blade, slip coupler and rods are advanced to the desired test depth through a cased hole, typically using AWJ drill rods or one-meter length rods with an outer diameter of 1.5 inches (38.1 millimeters). Test depths are referenced to the middle of the rectangular portion of the vane blade. The motor rotates the rods at a near constant rate up to and beyond the yield stress (peak) until the load remains near constant (post peak). Following post peak readings, the vane blade is then rapidly rotated clockwise ten times to completely remold the soil. The test procedure is repeated in order to record the remolded strength of the soil. The vane blade is then advanced to the next depth and the procedure is repeated or the vane blade is retracted to allow for drilling and vane blade size changes. Once the vane profile is complete, the final baseline of the load cell is recorded and compared to previous reading as a QA/QC check.

Undrained shear strength from the field vane,  $(S_u)_{fv}$ , is calculated from torque measurements using the following general equation ([ASTM D2573](#)) taking into consideration the case of rectangular or tapered ends at the top and/or bottom of the vane blade.

$$(S_u)_{fv} = \frac{12 \cdot T_{\max}}{\pi D^2 \left( \frac{D}{\cos(i_T)} + \frac{D}{\cos(i_B)} + 6H \right)}$$



where:

$(S_u)_{fv}$  = undrained shear strength from the field vane

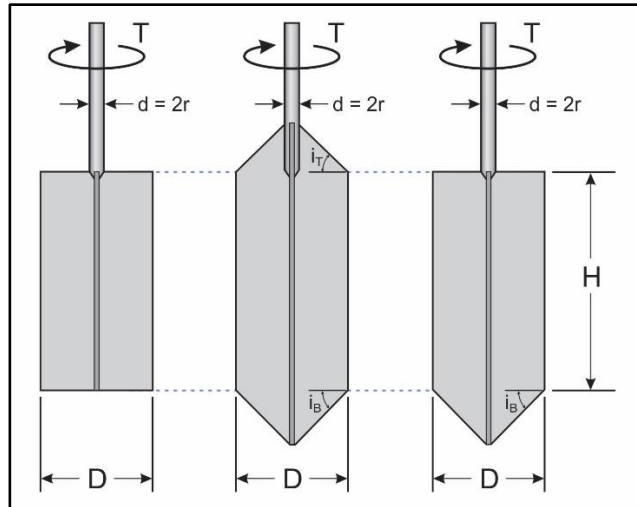
$T_{max}$  = maximum value of torque

$D$  = vane diameter

$H$  = height of the rectangular portion of the vane

$i_T$  = angle of taper at vane top (with respect to horizontal)

$i_B$  = angle of taper at vane bottom (with respect to horizontal)



For rectangular vane blades where  $H/D = 2$ , the above equation simplifies to:

$$(S_u)_{fv} = \frac{6 \cdot T_{max}}{7\pi D^3}$$

The recorded rod friction is subtracted from the peak and remolded torque. No correction factors are applied to the vane results to derive the mobilized shear strength ( $\tau_{mobilized}$ ).

A summary of the vane shear tests, a table of results and individual VST plots are provided in the relevant appendices. Tabular data in Excel format is provided in the data release folder.

#### References

ASTM D2573 / D2573M-18, 2018, "Standard Test Method for Field Vane Shear Test in Saturated Fine-Grained Soils", ASTM International, West Conshohocken, PA. DOI: [10.1520/D2573\\_D2573M-18](https://doi.org/10.1520/D2573_D2573M-18).

Greig, J.W., R.G. Campanella and P.K. Robertson, 1987, "Comparison of Field Vane Results With Other In-Situ Test Results", International Symposium on Laboratory and Field Vane Shear Strength Testing, ASTM, Tampa, FL, Proceedings.

The appendices listed below are included in the report:

- Cone Penetration Test Summary and Standard Cone Penetration Test Plots
- Advanced Cone Penetration Test Plots with  $I_c$ ,  $S_u(N_{kt})$ ,  $\Phi$  and  $N(60)I_c/N1(60)I_c$
- Soil Behavior Type (SBT) Scatter Plots
- Ball Cone Penetration Test Summary and Plots
- Electronic Vane Test Summary and Results
- Electronic Vane Test Plots

# Cone Penetration Test Summary and Standard Cone Penetration Test Plots



Job No: 21-59-22445  
Client: Anchor QEA  
Project: LDW Phase 3  
Start Date: 06-Jul-2021  
End Date: 29-Jul-2021

### CONE PENETRATION TEST SUMMARY

Sounding ID	File Name	Date	Cone	Assumed Phreatic Surface <sup>1</sup> (ft)	Final Depth (ft)	Latitude <sup>3</sup> (deg)	Longitude <sup>3</sup> (deg)	Refer to Notation Number
LDW21-GT06-GC	21-59-22445_CP06	22-Jul-2021	681:T375F10U35	-5.0	31.1	47.52892	-122.31483	
LDW21-GT14-GC	21-59-22445_CP14	08-Jul-2021	681:T375F10U35	-5.6	28.7	47.52477	-122.30819	
LDW21-GT16-GC	21-59-22445_CP16	08-Jul-2021	681:T375F10U35	-8.4	29.8	47.52409	-122.30770	
LDW21-GT17-GC	21-59-22445_CP17	12-Jul-2021	681:T375F10U35	-6.6	30.3			4
LDW21-GT20-GC	21-59-22445_CP20	16-Jul-2021	681:T375F10U35	-6.6	23.0			4
LDW21-GT22-GC	21-59-22445_CP22	13-Jul-2021	681:T375F10U35	-7.7	28.8			4
LDW21-GT27-GC	21-59-22445_CP27	16-Jul-2021	681:T375F10U35	-3.0	30.4			4
LDW21-GT30-GC	21-59-22445_CP30	21-Jul-2021	681:T375F10U35	-7.0	30.1	47.52066	-122.30558	
LDW21-GT31-GC	21-59-22445_CP31	09-Jul-2021	681:T375F10U35	2.0	11.4			4,2
LDW21-GT31-GC-B	21-59-22445_CP31B	13-Jul-2021	681:T375F10U35	-5.0	27.3			4
LDW21-GT32-GC	21-59-22445_CP32	09-Jul-2021	681:T375F10U35	2.0	5.8	47.52028	-122.30553	2
LDW21-GT32-GC-B	21-59-22445_CP32B	21-Jul-2021	681:T375F10U35	-2.0	30.8	47.52030	-122.30555	
LDW21-GT34-GC	21-59-22445_CP34	21-Jul-2021	681:T375F10U35	-2.8	30.3	47.51986	-122.30540	
LDW21-GT40-GC	21-59-22445_CP40	19-Jul-2021	681:T375F10U35	-4.9	31.7	47.51155	-122.30247	
LDW21-GT45-GC	21-59-22445_CP45	28-Jul-2021	681:T375F10U35	-7.2	31.6	47.51254	-122.29899	
LDW21-GT46-GC	21-59-22445_CP46	26-Jul-2021	681:T375F10U35	-13.2	9.8	47.51233	-122.29862	
LDW21-GT47-GC	21-59-22445_CP47	27-Jul-2021	681:T375F10U35	-12.5	31.2	47.51242	-122.29865	
LDW21-GT49-GC	21-59-22445_CP49	28-Jul-2021	681:T375F10U35	-6.5	32.5	47.51235	-122.29820	
LDW21-GT50-GC	21-59-22445_CP50	23-Jul-2021	681:T375F10U35	-11.6	5.5	47.51207	-122.29793	

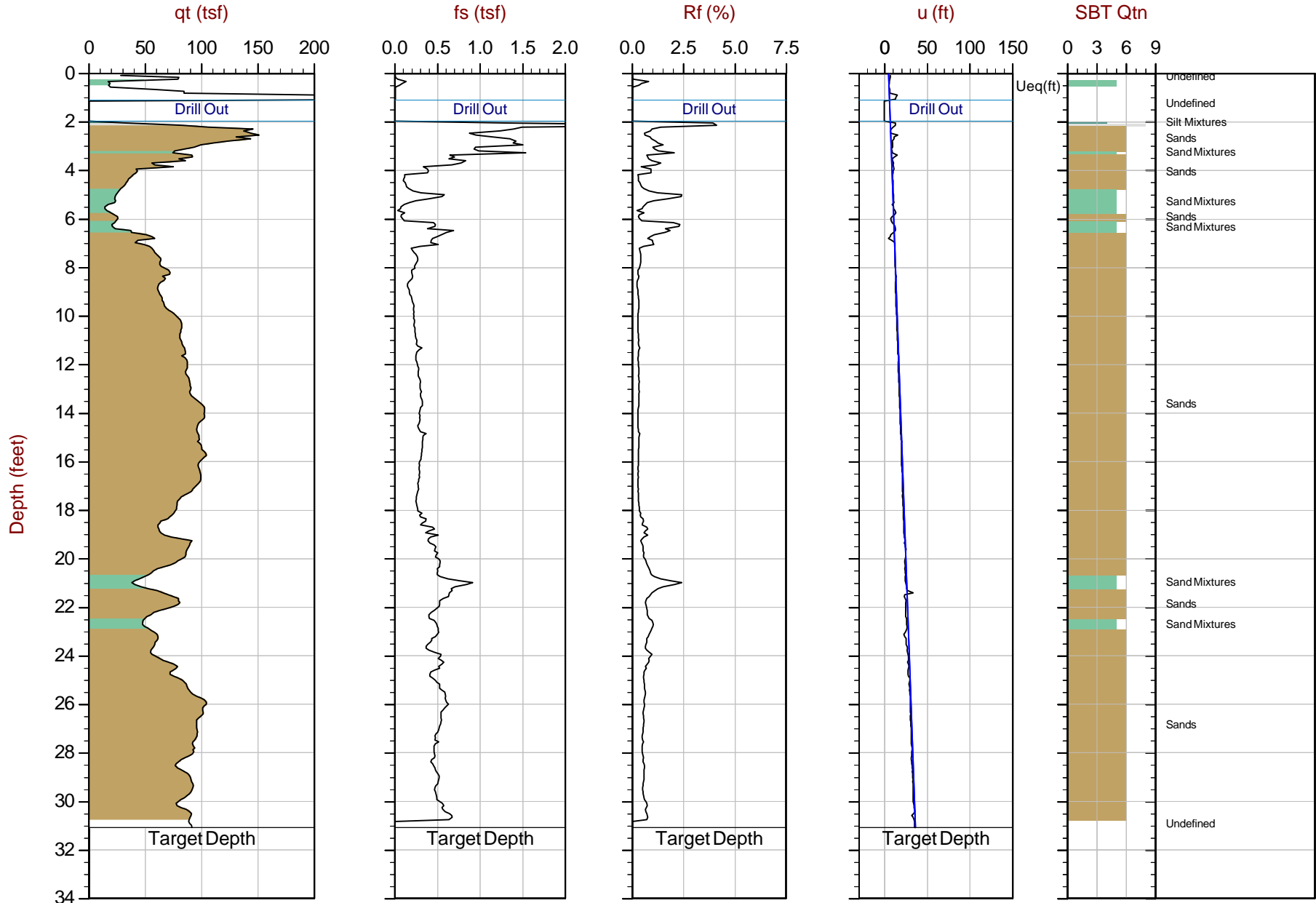


Job No: 21-59-22445  
Client: Anchor QEA  
Project: LDW Phase 3  
Start Date: 06-Jul-2021  
End Date: 29-Jul-2021

### CONE PENETRATION TEST SUMMARY

Sounding ID	File Name	Date	Cone	Assumed Phreatic Surface <sup>1</sup> (ft)	Final Depth (ft)	Latitude <sup>3</sup> (deg)	Longitude <sup>3</sup> (deg)	Refer to Notation Number
LDW21-GT51-GC	21-59-22445_CP51	26-Jul-2021	681:T375F10U35	-6.4	6.6	47.51218	-122.29794	
LDW21-GT52-GC	21-59-22445_CP52	27-Jul-2021	681:T375F10U35	-6.9	30.4	47.51211	-122.29774	
LDW21-GT54-GC	21-59-22445_CP54	27-Jul-2021	681:T375F10U35	-6.0	30.8	47.51197	-122.29758	
Totals	22 soundings				547.89			

1. Phreatic surface measured from barge deck with weighted tip tape at each location. Hydrostatic profile applied to interpretation tables
2. CPT sounding completed from land based machine - all other locations completed from floating barge platform.
3. Coordinates were provided by client
4. Coordinates currently not available. Coordinates will be provided by client at a later date



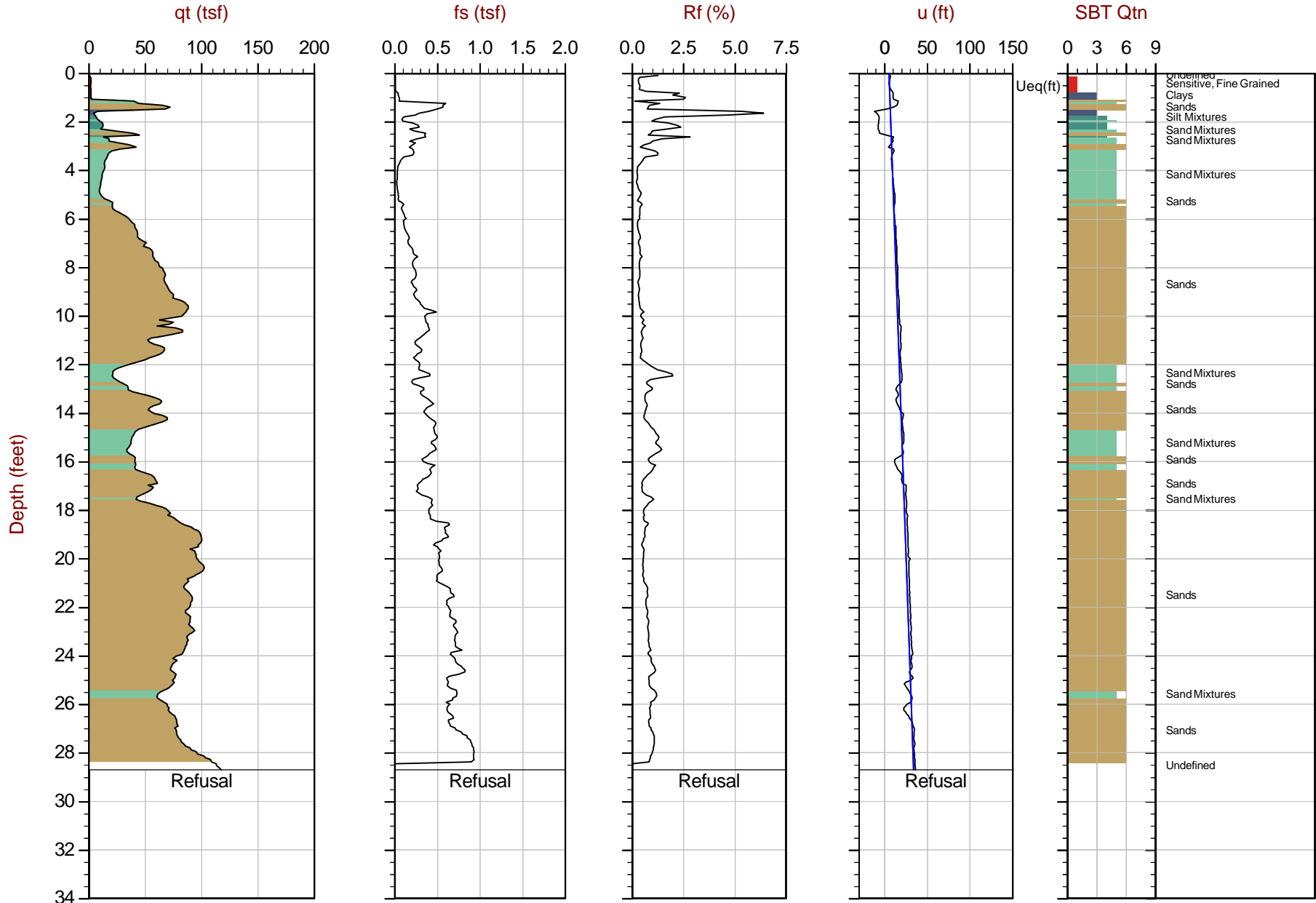
Max Depth: 9.475 m / 31.09 ft  
 Depth Inc: 0.025 m / 0.082 ft  
 Avg Int: Every Point

File: 21-59-22445\_CP06.COR  
 Unit Wt: SBTQtn(PKR2009)

SBT: Robertson, 2009 and 2010  
 Coords: Lat: 47.52892 Long: -122.31483

● Equilibrium Pore Pressure (Ueq)    
 ● Assumed Ueq    
 ◀ Dissipation, Ueq achieved    
 ◀ Dissipation, Ueq not achieved    
 — Hydrostatic Line

The reported coordinates were acquired from hand-held GPS equipment and are only approximate locations. The coordinates should not be used for design purposes.



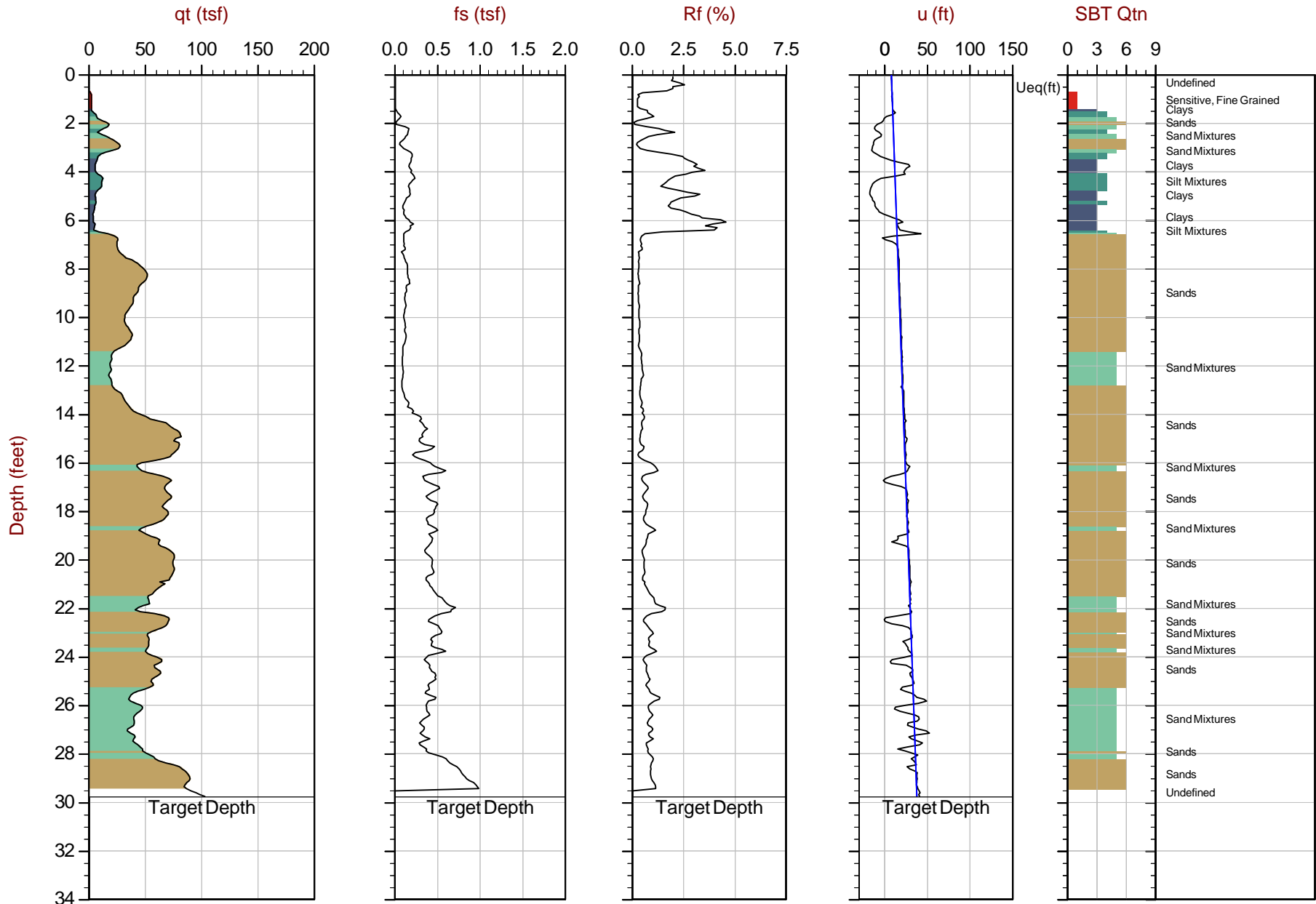
Max Depth: 8.750 m / 28.71 ft  
 Depth Inc: 0.025 m / 0.082 ft  
 Avg Int: Every Point

File: 21-59-22445\_CP14.COR  
 Unit Wt: SBTQtn(PKR2009)

SBT: Robertson, 2009 and 2010  
 Coords: Lat: 47.52477 Long: -122.30819

● Equilibrium Pore Pressure (Ueq)    
 ● Assumed Ueq    
 ◀ Dissipation, Ueq achieved    
 ◀ Dissipation, Ueq not achieved    
 — Hydrostatic Line

The reported coordinates were acquired from hand-held GPS equipment and are only approximate locations. The coordinates should not be used for design purposes.



Max Depth: 9.075 m / 29.77 ft  
 Depth Inc: 0.025 m / 0.082 ft  
 Avg Int: Every Point

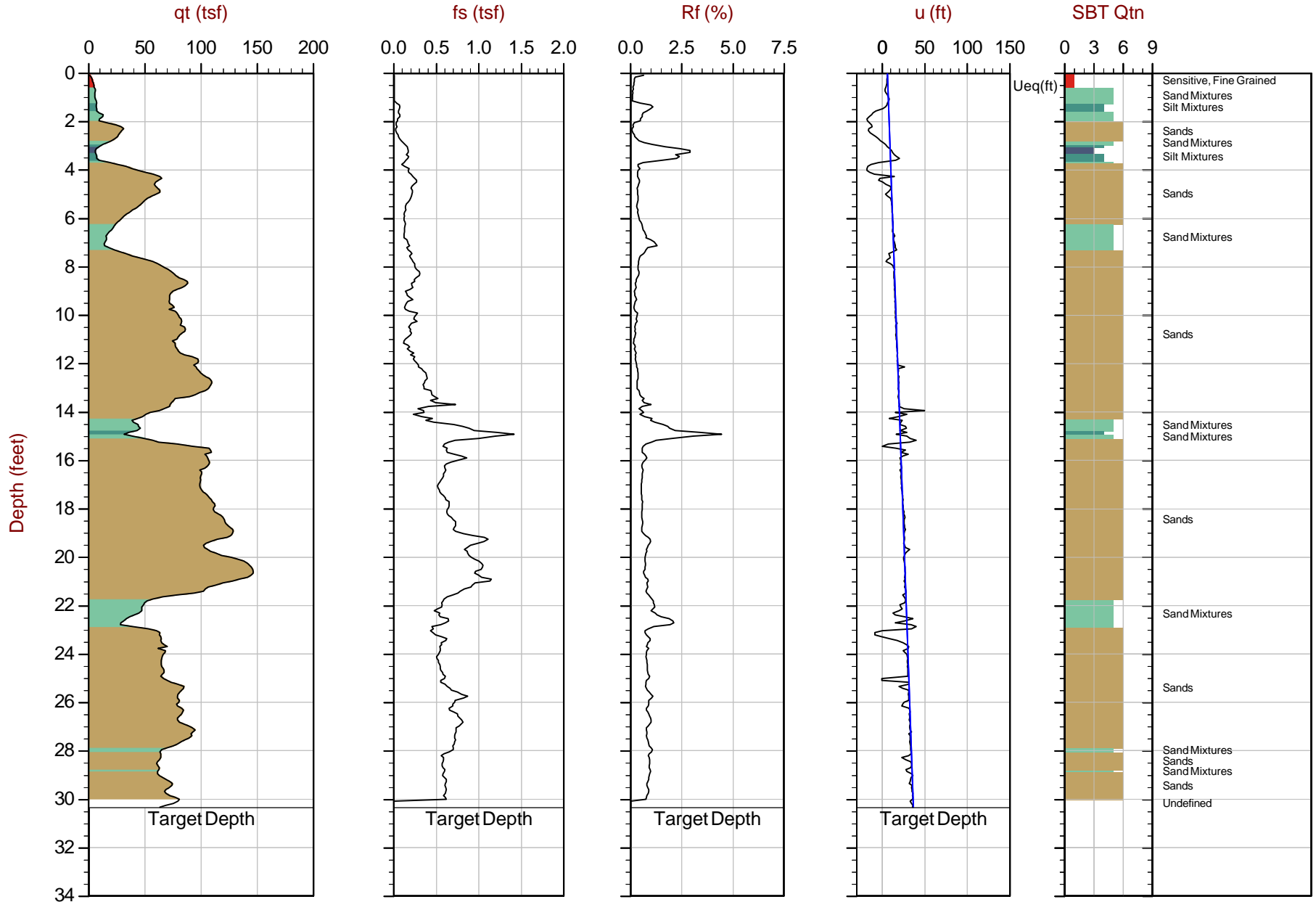
File: 21-59-22445\_CP16.COR  
 Unit Wt: SBTQtn(PKR2009)

SBT: Robertson, 2009 and 2010  
 Coords: Lat: 47.52409 Long: -122.30770

● Equilibrium Pore Pressure (Ueq)    
 ● Assumed Ueq    
 ◀ Dissipation, Ueq achieved    
 ◀ Dissipation, Ueq not achieved    
 — Hydrostatic Line

The reported coordinates were acquired from hand-held GPS equipment and are only approximate locations. The coordinates should not be used for design purposes.





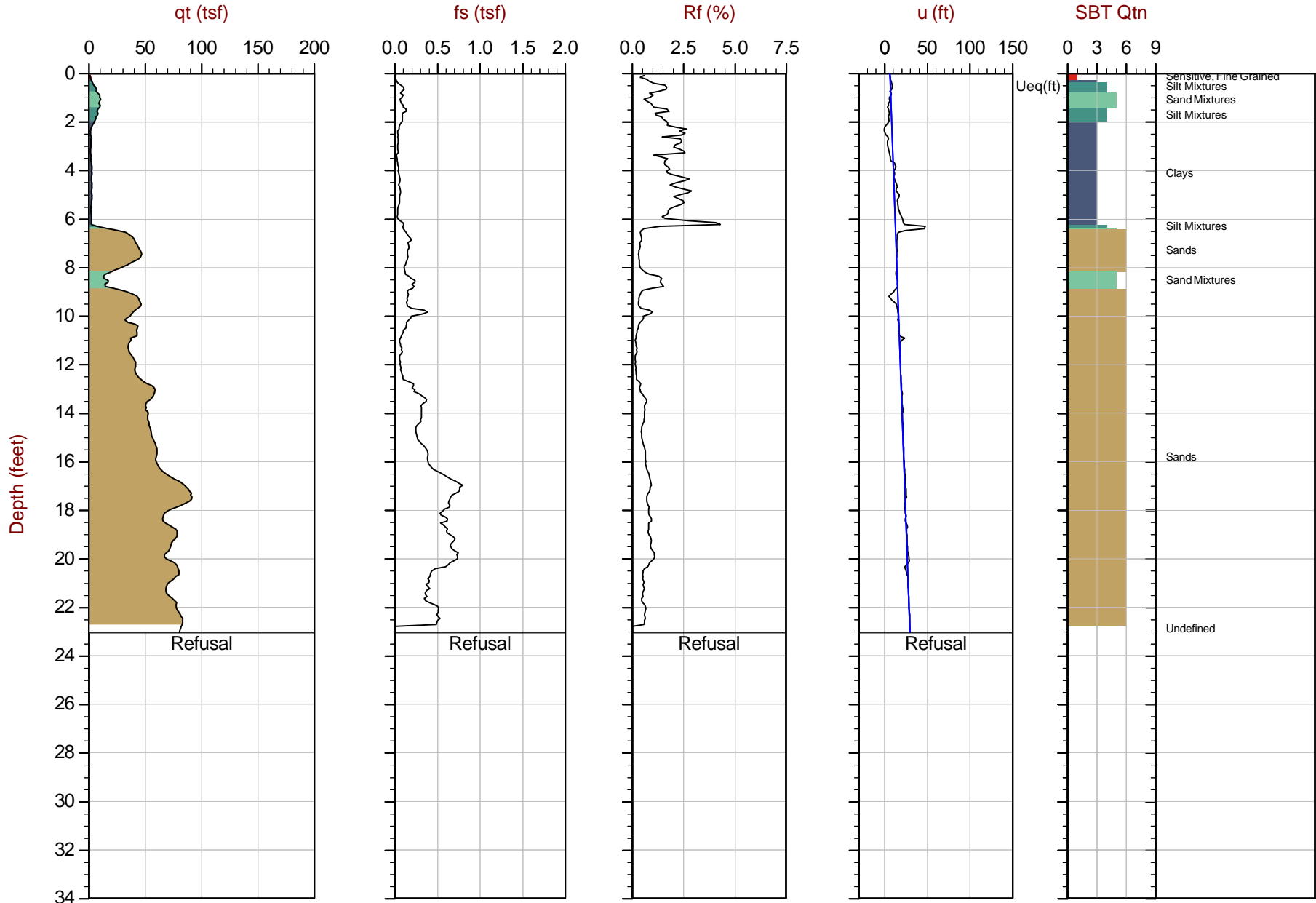
Max Depth: 9.250 m / 30.35 ft  
 Depth Inc: 0.025 m / 0.082 ft  
 Avg Int: Every Point

File: 21-59-22445\_CP17.COR  
 Unit Wt: SBTQtn(PKR2009)

SBT: Robertson, 2009 and 2010  
 Coords: Lat: N/A Long: N/A

● Equilibrium Pore Pressure (Ueq)    
 ○ Assumed Ueq    
 ◀ Dissipation, Ueq achieved    
 ◀ Dissipation, Ueq not achieved    
 — Hydrostatic Line

The reported coordinates were acquired from hand-held GPS equipment and are only approximate locations. The coordinates should not be used for design purposes.



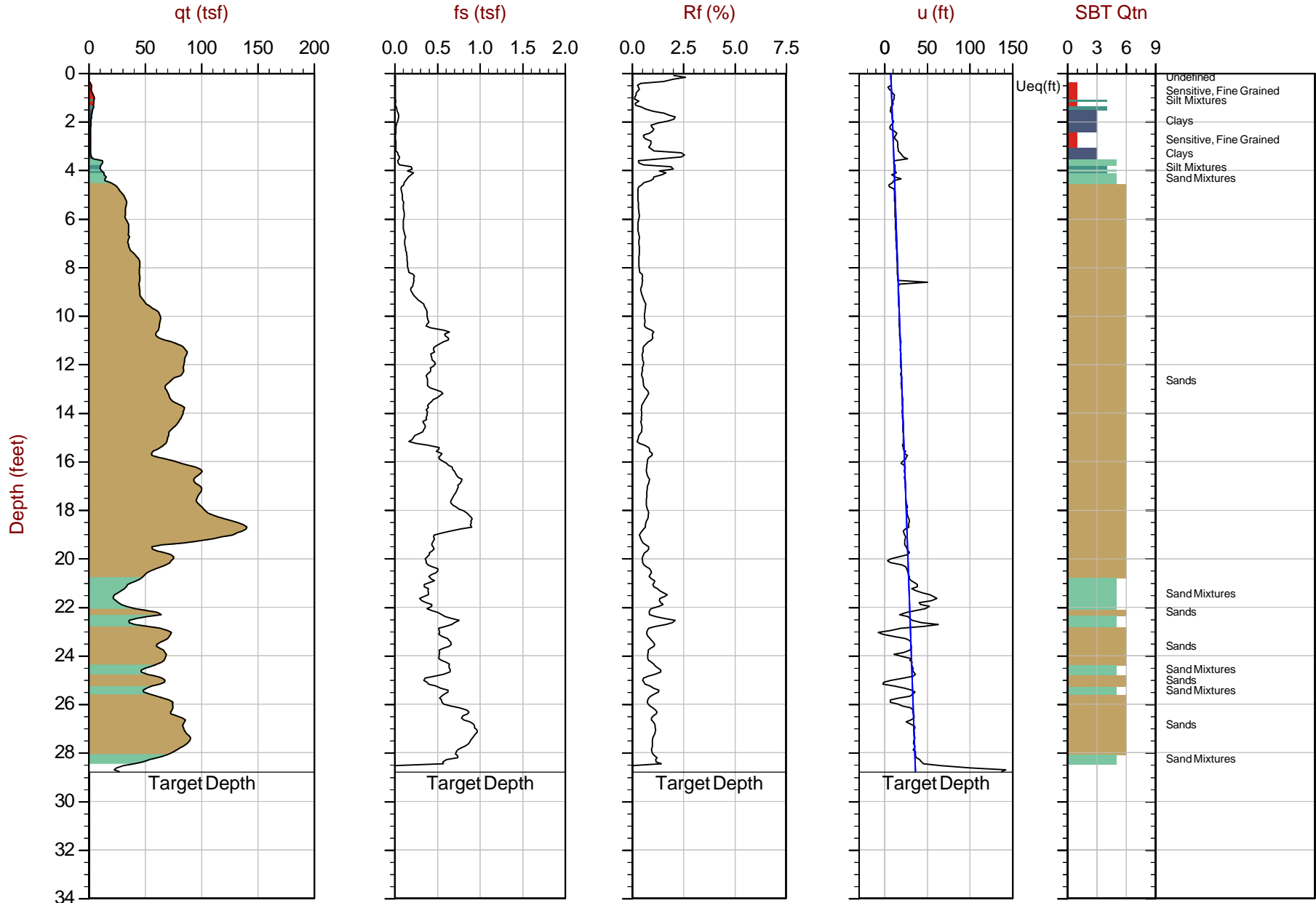
Max Depth: 7.025 m / 23.05 ft  
 Depth Inc: 0.025 m / 0.082 ft  
 Avg Int: Every Point

File: 21-59-22445\_CP20.COR  
 Unit Wt: SBTQtn(PKR2009)

SBT: Robertson, 2009 and 2010  
 Coords: Lat: N/A Long: N/A

● Equilibrium Pore Pressure (Ueq)    
 ● Assumed Ueq    
 ◀ Dissipation, Ueq achieved    
 ◀ Dissipation, Ueq not achieved    
 — Hydrostatic Line

The reported coordinates were acquired from hand-held GPS equipment and are only approximate locations. The coordinates should not be used for design purposes.



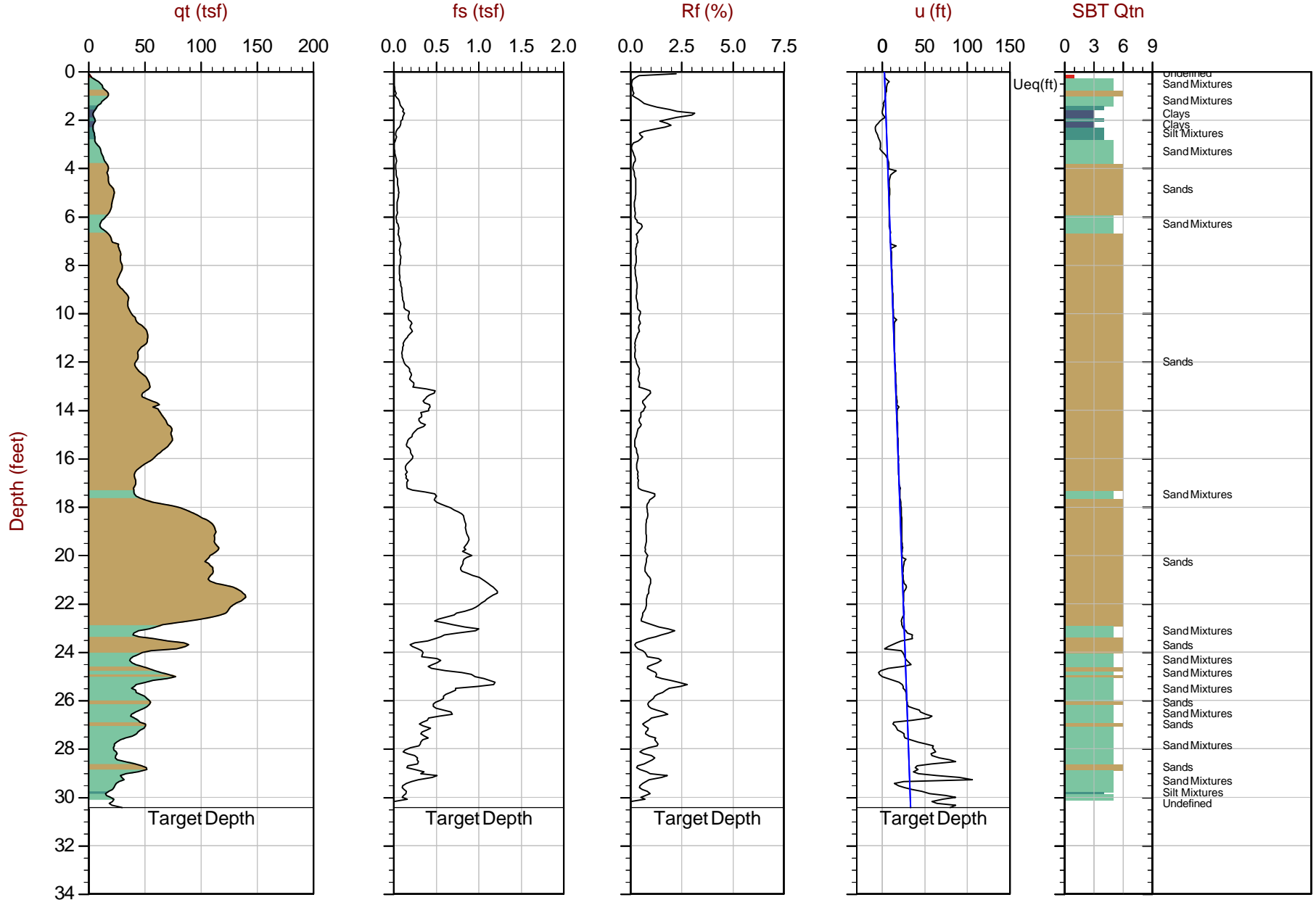
Max Depth: 8.775 m / 28.79 ft  
 Depth Inc: 0.025 m / 0.082 ft  
 Avg Int: Every Point

File: 21-59-22445\_CP22.COR  
 Unit Wt: SBTQtn(PKR2009)

SBT: Robertson, 2009 and 2010  
 Coords: Lat: N/A Long: N/A

● Equilibrium Pore Pressure (Ueq)    
 ● Assumed Ueq    
 ◀ Dissipation, Ueq achieved    
 ◀ Dissipation, Ueq not achieved    
 — Hydrostatic Line

The reported coordinates were acquired from hand-held GPS equipment and are only approximate locations. The coordinates should not be used for design purposes.



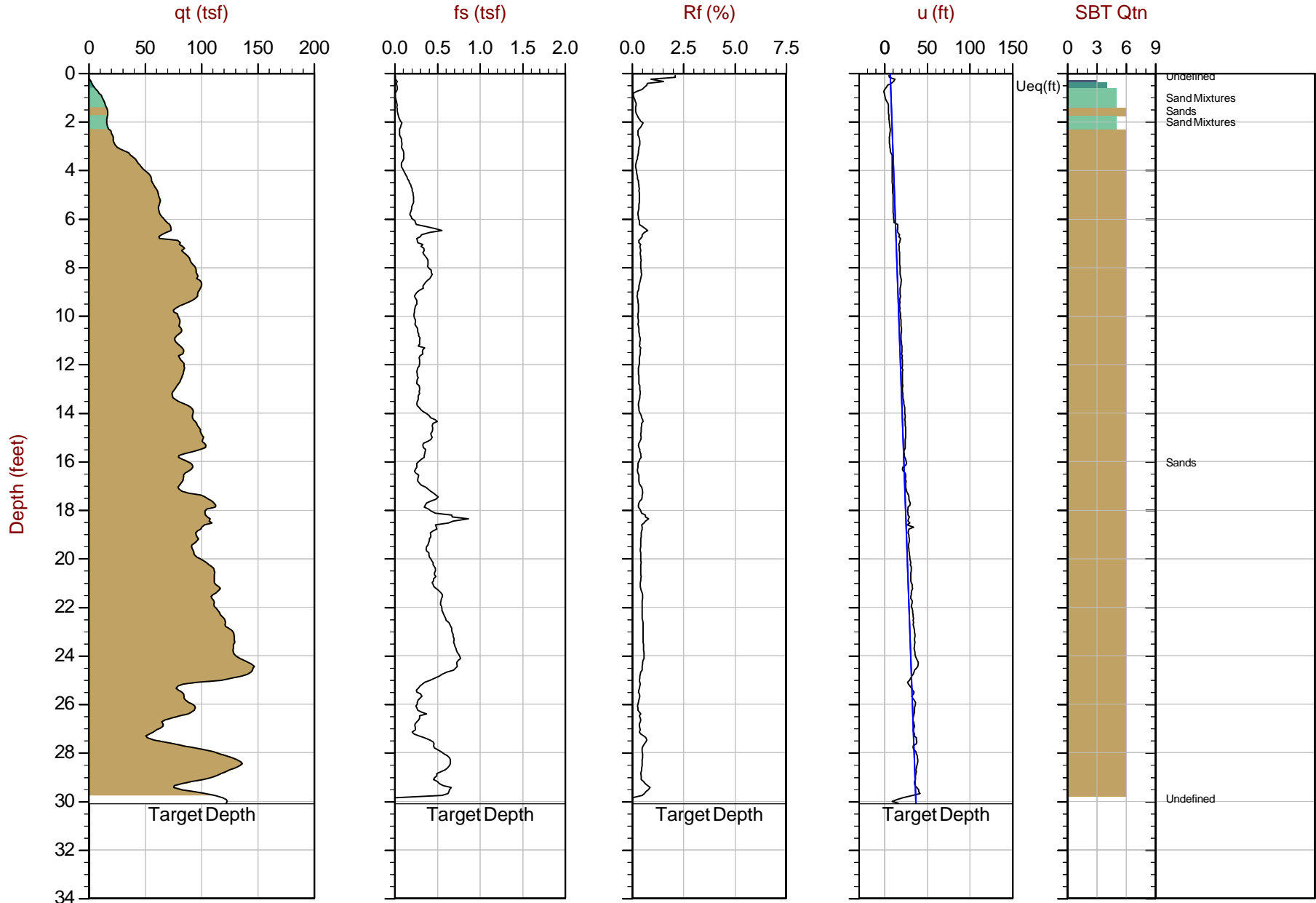
Max Depth: 9.275 m / 30.43 ft  
 Depth Inc: 0.025 m / 0.082 ft  
 Avg Int: Every Point

File: 21-59-22445\_CP27.COR  
 Unit Wt: SBTQtn(PKR2009)

SBT: Robertson, 2009 and 2010  
 Coords: Lat: N/A Long: N/A

● Equilibrium Pore Pressure (Ueq)     
 ● Assumed Ueq     
 ◀ Dissipation, Ueq achieved     
 ◀ Dissipation, Ueq not achieved     
 — Hydrostatic Line

The reported coordinates were acquired from hand-held GPS equipment and are only approximate locations. The coordinates should not be used for design purposes.



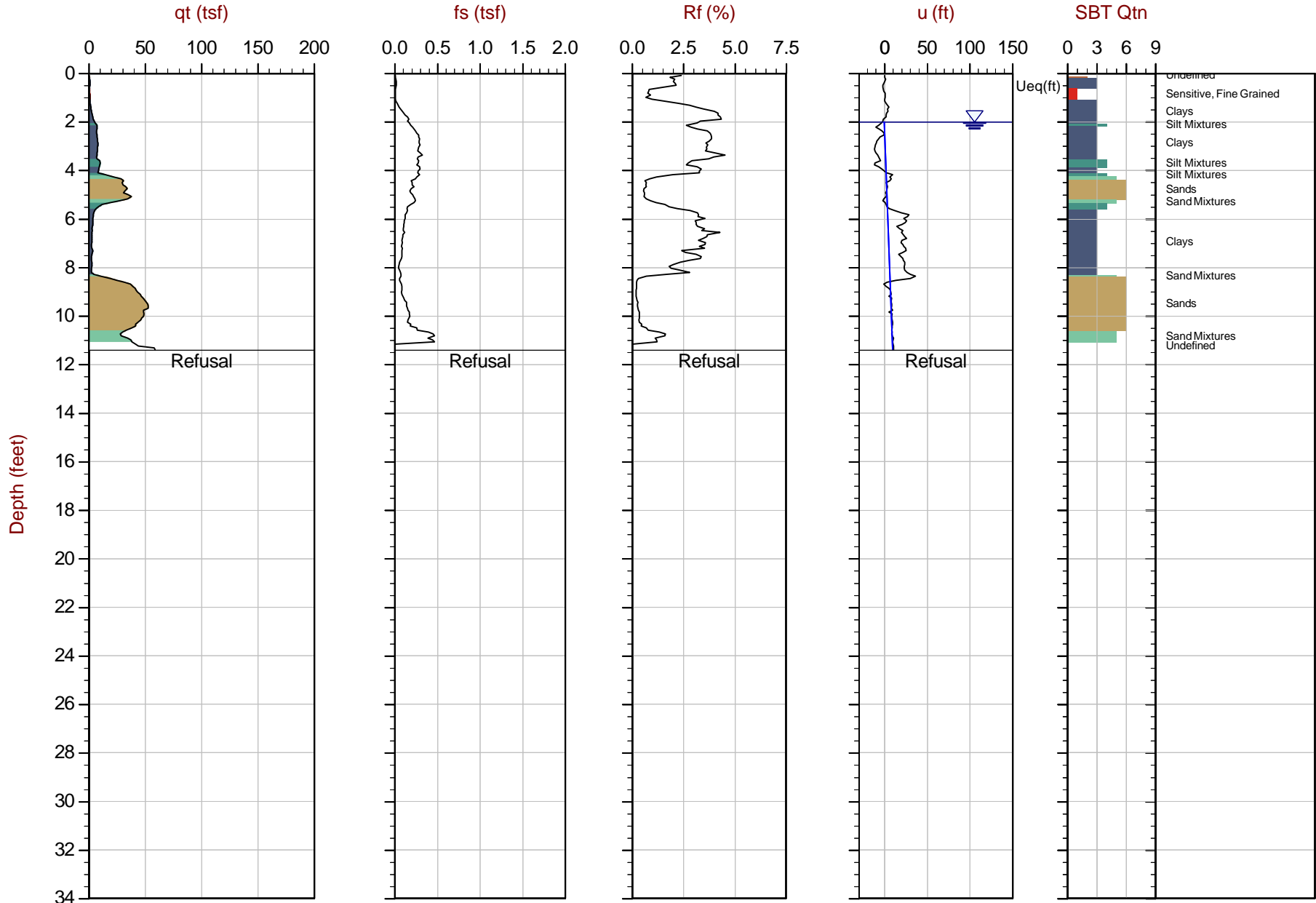
Max Depth: 9.175 m / 30.10 ft  
 Depth Inc: 0.025 m / 0.082 ft  
 Avg Int: Every Point

File: 21-59-22445\_CP30.COR  
 Unit Wt: SBTQtn (PKR2009)

SBT: Robertson, 2009 and 2010  
 Coords: Lat: 47.52066 Long: -122.30558

● Equilibrium Pore Pressure (Ueq)    
 ● Assumed Ueq    
 ◀ Dissipation, Ueq achieved    
 ◀ Dissipation, Ueq not achieved    
 — Hydrostatic Line

The reported coordinates were acquired from hand-held GPS equipment and are only approximate locations. The coordinates should not be used for design purposes.



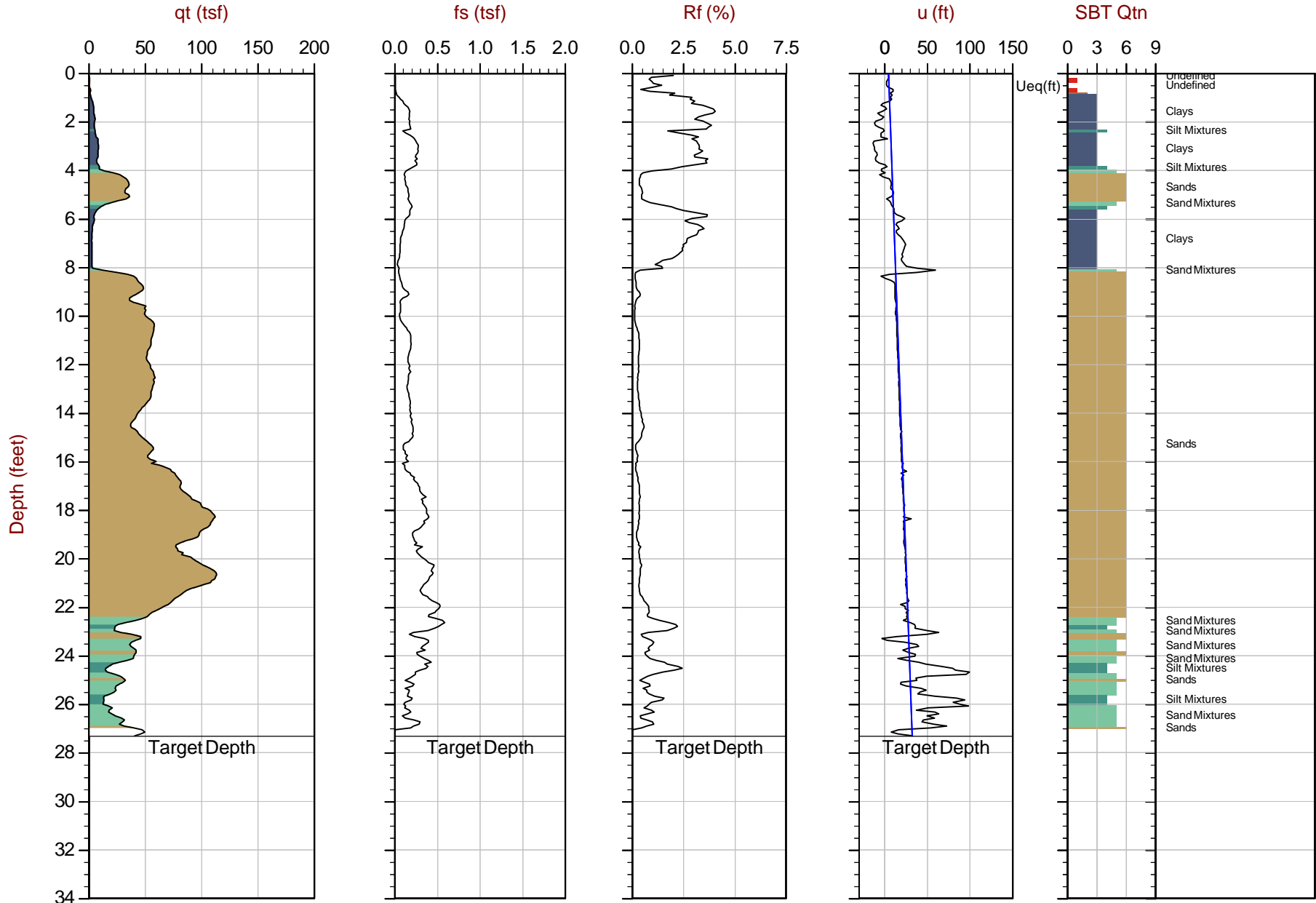
Max Depth: 3.475 m / 11.40 ft  
 Depth Inc: 0.025 m / 0.082 ft  
 Avg Int: Every Point

File: 21-59-22445\_CP31.COR  
 Unit Wt: SBTQtn(PKR2009)

SBT: Robertson, 2009 and 2010  
 Coords: Lat: N/A Long: N/A

● Equilibrium Pore Pressure (Ueq)    
 ● Assumed Ueq    
 ◀ Dissipation, Ueq achieved    
 ◀ Dissipation, Ueq not achieved    
 — Hydrostatic Line

The reported coordinates were acquired from hand-held GPS equipment and are only approximate locations. The coordinates should not be used for design purposes.

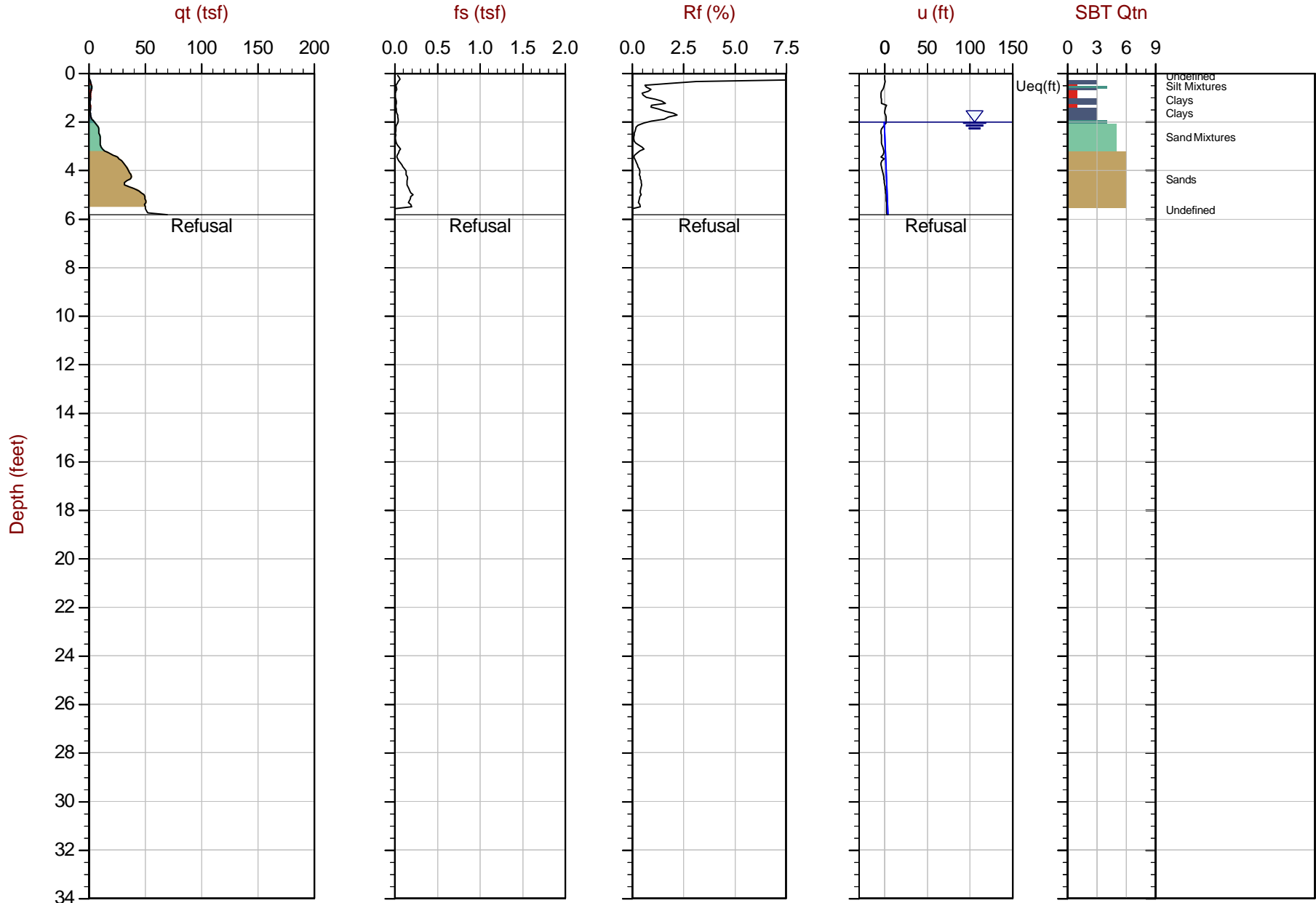


Max Depth: 8.325 m / 27.31 ft  
 Depth Inc: 0.025 m / 0.082 ft  
 Avg Int: Every Point

File: 21-59-22445\_CP31B.COR  
 Unit Wt: SBTQtn(PKR2009)

SBT: Robertson, 2009 and 2010  
 Coords: Lat: N/A Long: N/A

● Equilibrium Pore Pressure (Ueq)    
 ● Assumed Ueq    
 ◀ Dissipation, Ueq achieved    
 ◀ Dissipation, Ueq not achieved    
 — Hydrostatic Line  
 The reported coordinates were acquired from hand-held GPS equipment and are only approximate locations. The coordinates should not be used for design purposes.



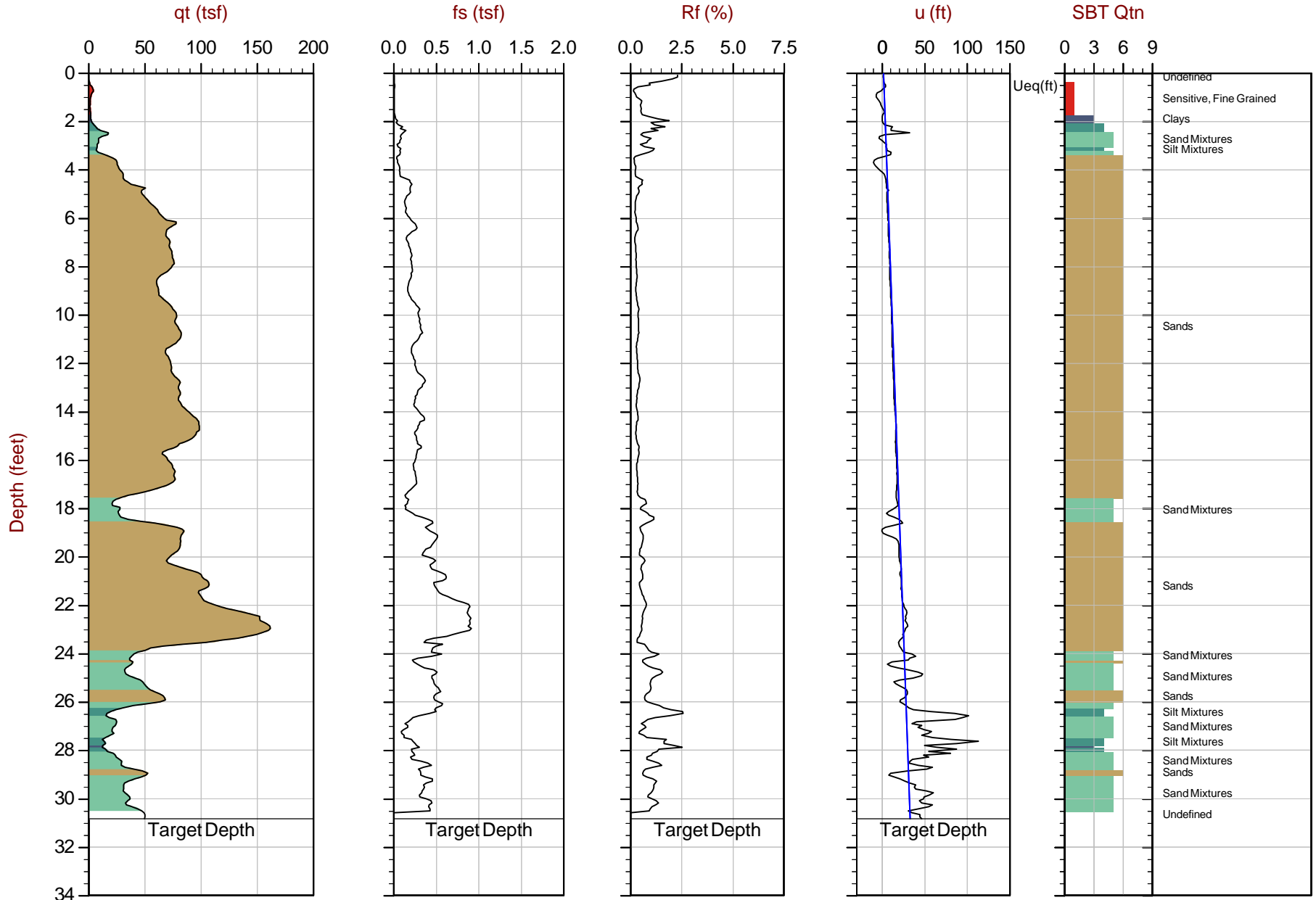
Max Depth: 1.775 m / 5.82 ft  
 Depth Inc: 0.025 m / 0.082 ft  
 Avg Int: Every Point

File: 21-59-22445\_CP32.COR  
 Unit Wt: SBTQtn(PKR2009)

SBT: Robertson, 2009 and 2010  
 Coords: Lat: 47.52028 Long: -122.30553

● Equilibrium Pore Pressure (Ueq)    
 ● Assumed Ueq    
 ◀ Dissipation, Ueq achieved    
 ◀ Dissipation, Ueq not achieved    
 — Hydrostatic Line  
 The reported coordinates were acquired from hand-held GPS equipment and are only approximate locations. The coordinates should not be used for design purposes.





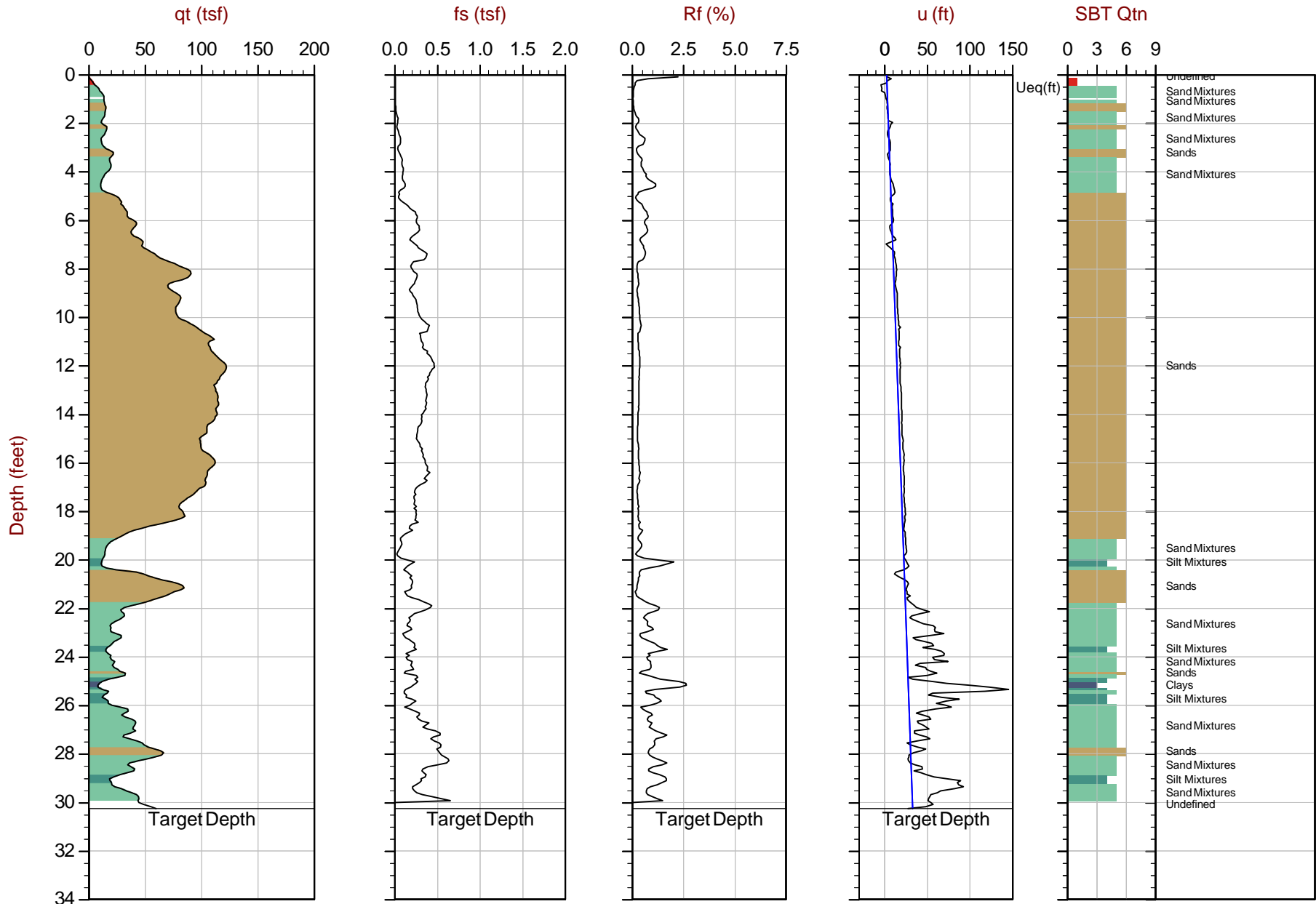
Max Depth: 9.400 m / 30.84 ft  
 Depth Inc: 0.025 m / 0.082 ft  
 Avg Int: Every Point

File: 21-59-22445\_CP32B.COR  
 Unit Wt: SBTQtn (PKR2009)

SBT: Robertson, 2009 and 2010  
 Coords: Lat: 47.52030 Long: -122.30555

● Equilibrium Pore Pressure (Ueq)    
 ● Assumed Ueq    
 ◀ Dissipation, Ueq achieved    
 ◀ Dissipation, Ueq not achieved    
 — Hydrostatic Line

The reported coordinates were acquired from hand-held GPS equipment and are only approximate locations. The coordinates should not be used for design purposes.

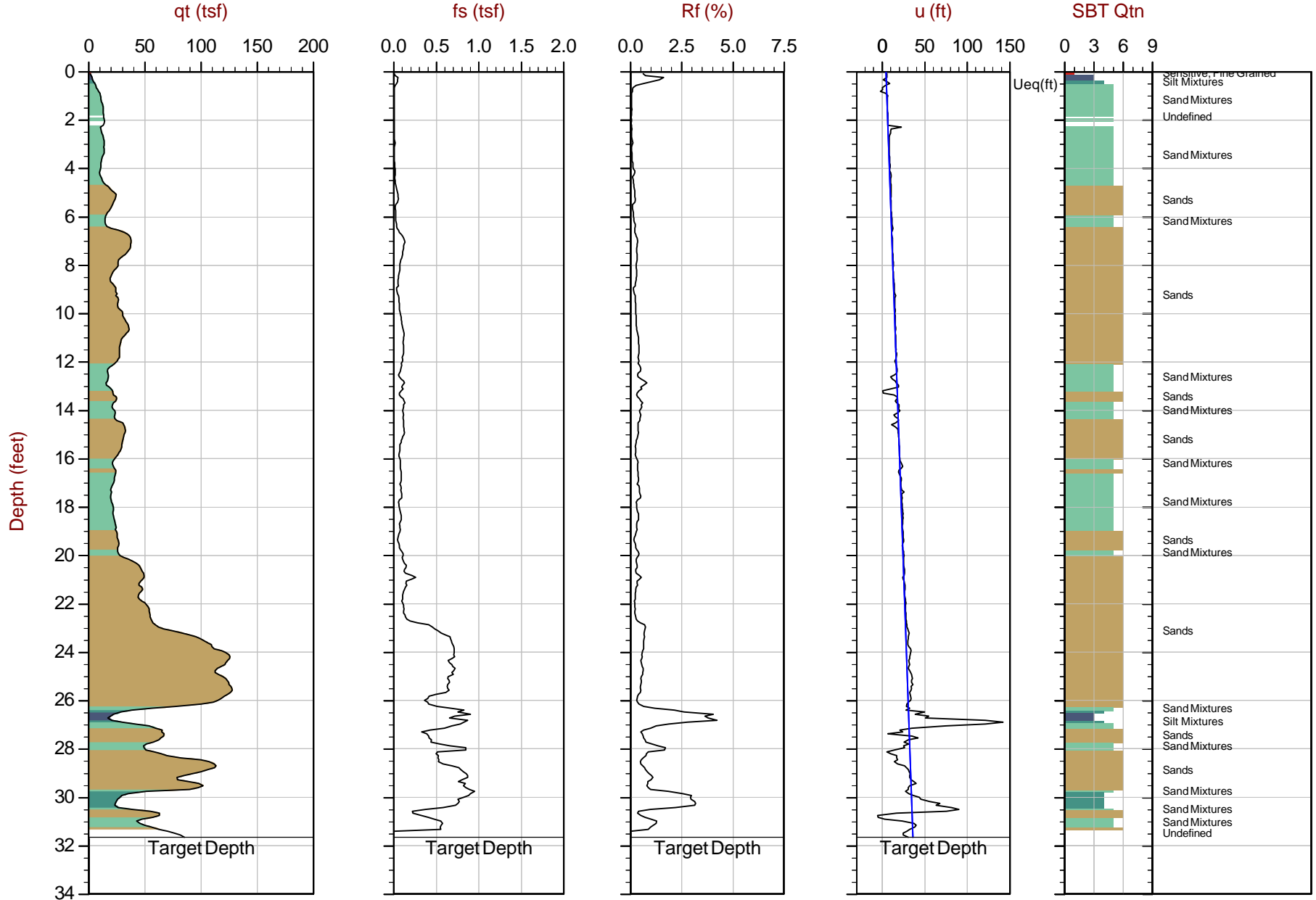


Max Depth: 9.225 m / 30.27 ft  
 Depth Inc: 0.025 m / 0.082 ft  
 Avg Int: Every Point

File: 21-59-22445\_CP34.COR  
 Unit Wt: SBTQtn (PKR2009)

SBT: Robertson, 2009 and 2010  
 Coords: Lat: 47.51986 Long: -122.30540

● Equilibrium Pore Pressure (Ueq)    
 ● Assumed Ueq    
 ◀ Dissipation, Ueq achieved    
 ◀ Dissipation, Ueq not achieved    
 — Hydrostatic Line  
 The reported coordinates were acquired from hand-held GPS equipment and are only approximate locations. The coordinates should not be used for design purposes.

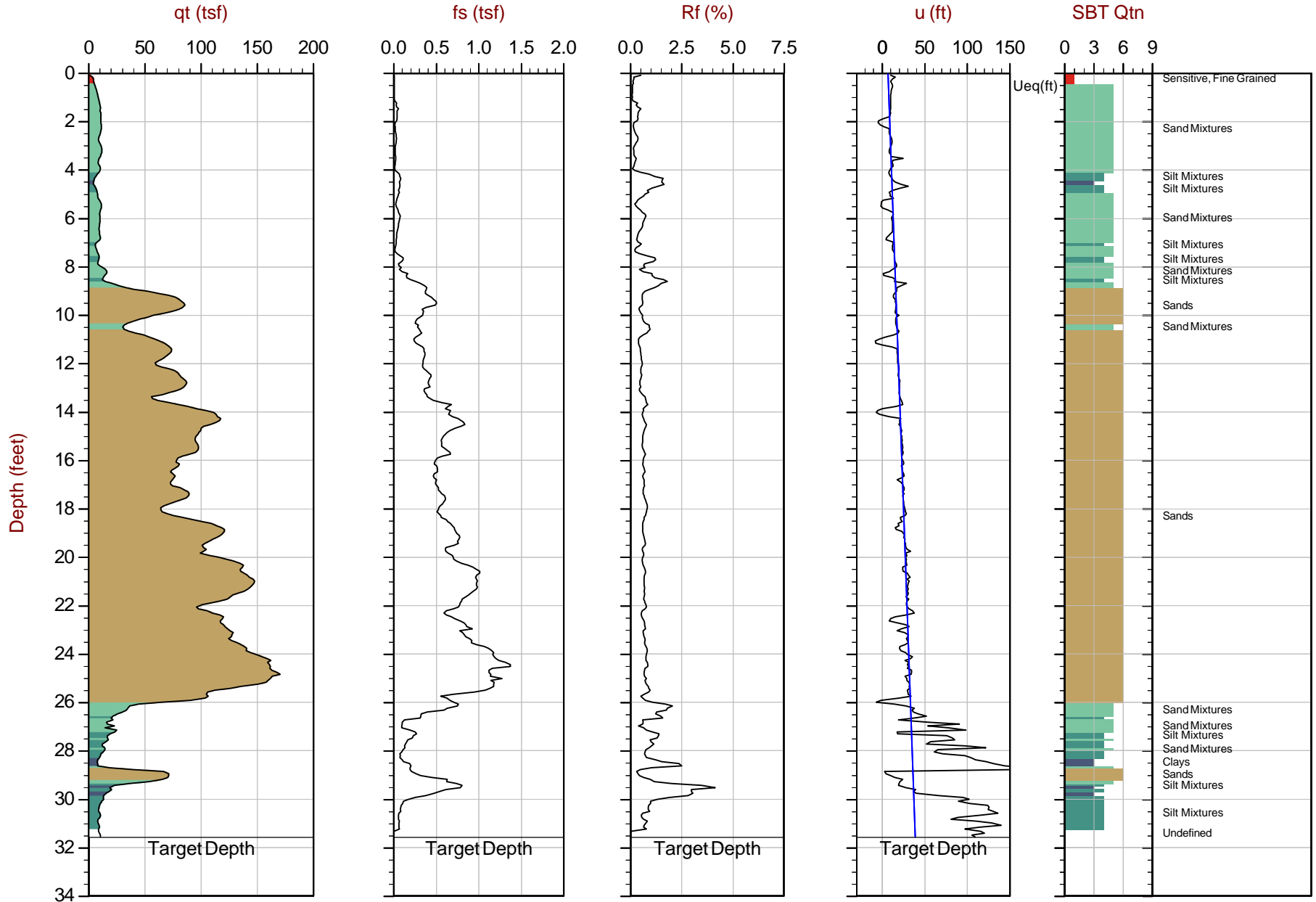


Max Depth: 9.650 m / 31.66 ft  
 Depth Inc: 0.025 m / 0.082 ft  
 Avg Int: Every Point

File: 21-59-22445\_CP40.COR  
 Unit Wt: SBTQtn(PKR2009)

SBT: Robertson, 2009 and 2010  
 Coords: Lat: 47.51155 Long: -122.30247

● Equilibrium Pore Pressure (Ueq)    
 ● Assumed Ueq    
 ◀ Dissipation, Ueq achieved    
 ◀ Dissipation, Ueq not achieved    
 — Hydrostatic Line  
 The reported coordinates were acquired from hand-held GPS equipment and are only approximate locations. The coordinates should not be used for design purposes.



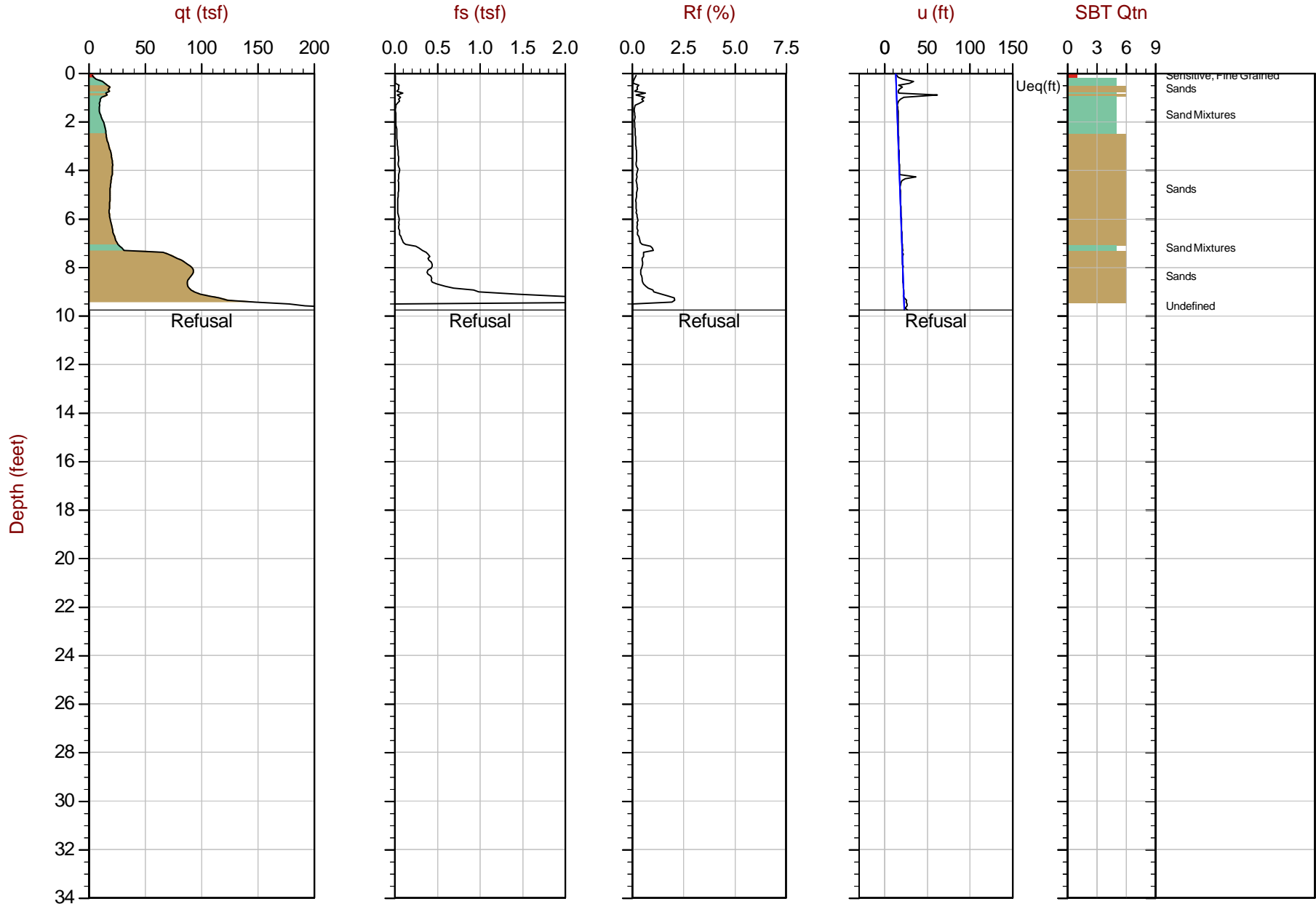
Max Depth: 9.625 m / 31.58 ft  
 Depth Inc: 0.025 m / 0.082 ft  
 Avg Int: Every Point

File: 21-59-22445\_CP45.COR  
 Unit Wt: SBTQtn(PKR2009)

SBT: Robertson, 2009 and 2010  
 Coords: Lat: 47.51253 Long: -122.29899

● Equilibrium Pore Pressure (Ueq)    
 ● Assumed Ueq    
 ◀ Dissipation, Ueq achieved    
 ◀ Dissipation, Ueq not achieved    
 — Hydrostatic Line

The reported coordinates were acquired from hand-held GPS equipment and are only approximate locations. The coordinates should not be used for design purposes.

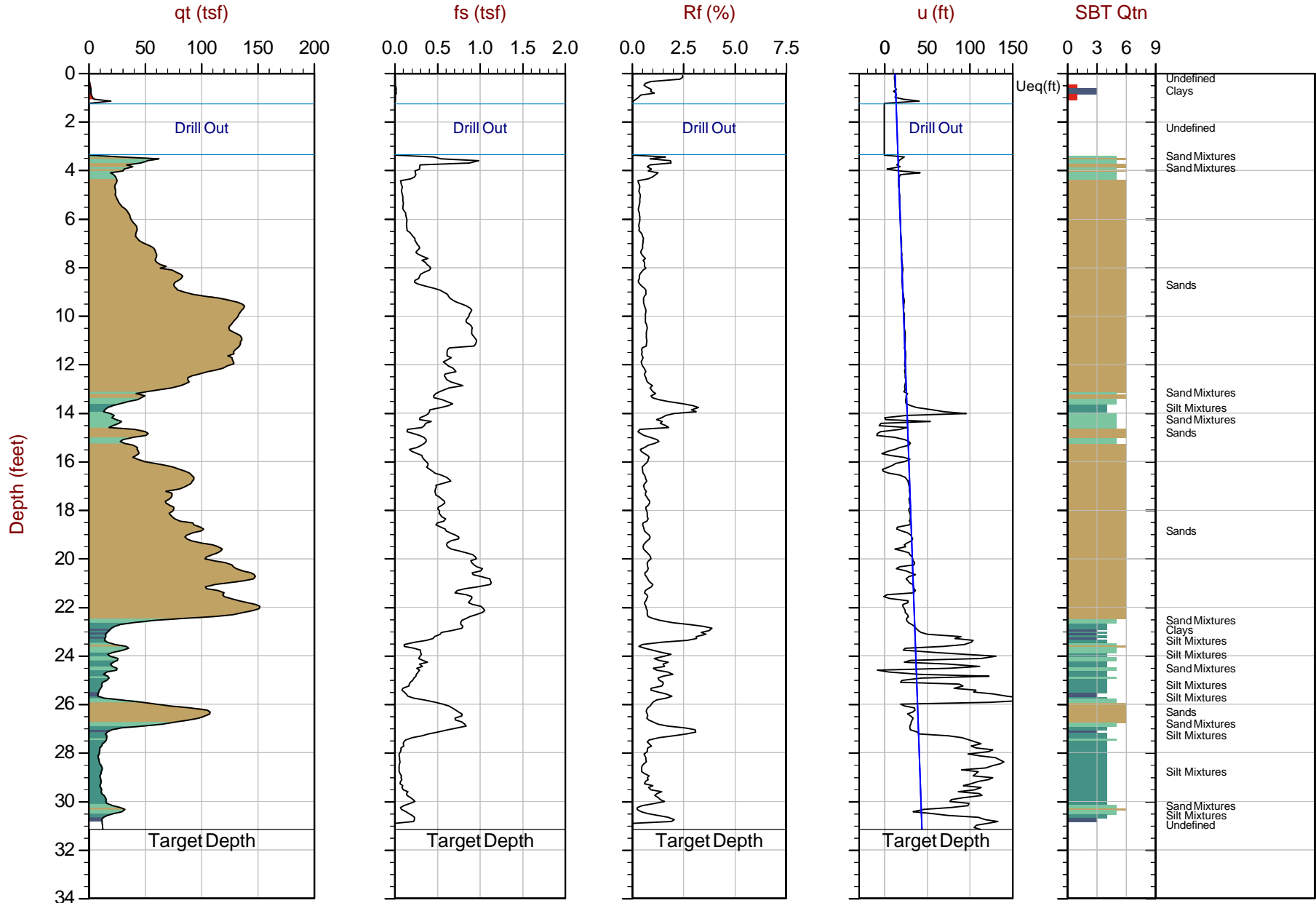


Max Depth: 2.975 m / 9.76 ft  
 Depth Inc: 0.025 m / 0.082 ft  
 Avg Int: Every Point

File: 21-59-22445\_CP46.COR  
 Unit Wt: SBTQtn(PKR2009)

SBT: Robertson, 2009 and 2010  
 Coords: Lat: 47.51233 Long: -122.29862

● Equilibrium Pore Pressure (Ueq)    
 ● Assumed Ueq    
 ◀ Dissipation, Ueq achieved    
 ◀ Dissipation, Ueq not achieved    
 — Hydrostatic Line  
 The reported coordinates were acquired from hand-held GPS equipment and are only approximate locations. The coordinates should not be used for design purposes.



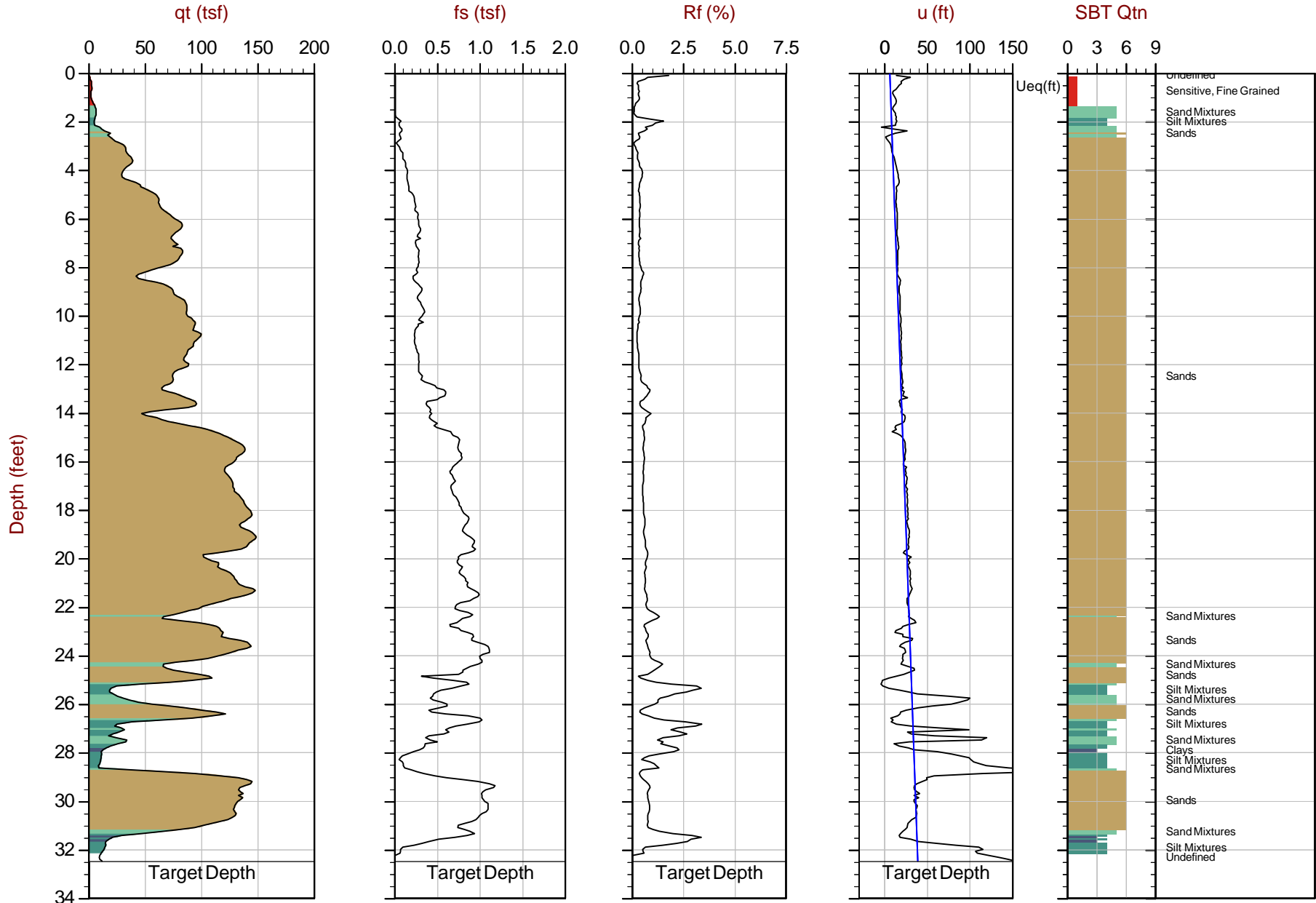
Max Depth: 9.500 m / 31.17 ft  
 Depth Inc: 0.025 m / 0.082 ft  
 Avg Int: Every Point

File: 21-59-22445\_CP47.COR  
 Unit Wt: SBTQtn(PKR2009)

SBT: Robertson, 2009 and 2010  
 Coords: Lat: 47.51242 Long: -122.29865

● Equilibrium Pore Pressure (Ueq)    
 ● Assumed Ueq    
 ◀ Dissipation, Ueq achieved    
 ◀ Dissipation, Ueq not achieved    
 — Hydrostatic Line

The reported coordinates were acquired from hand-held GPS equipment and are only approximate locations. The coordinates should not be used for design purposes.



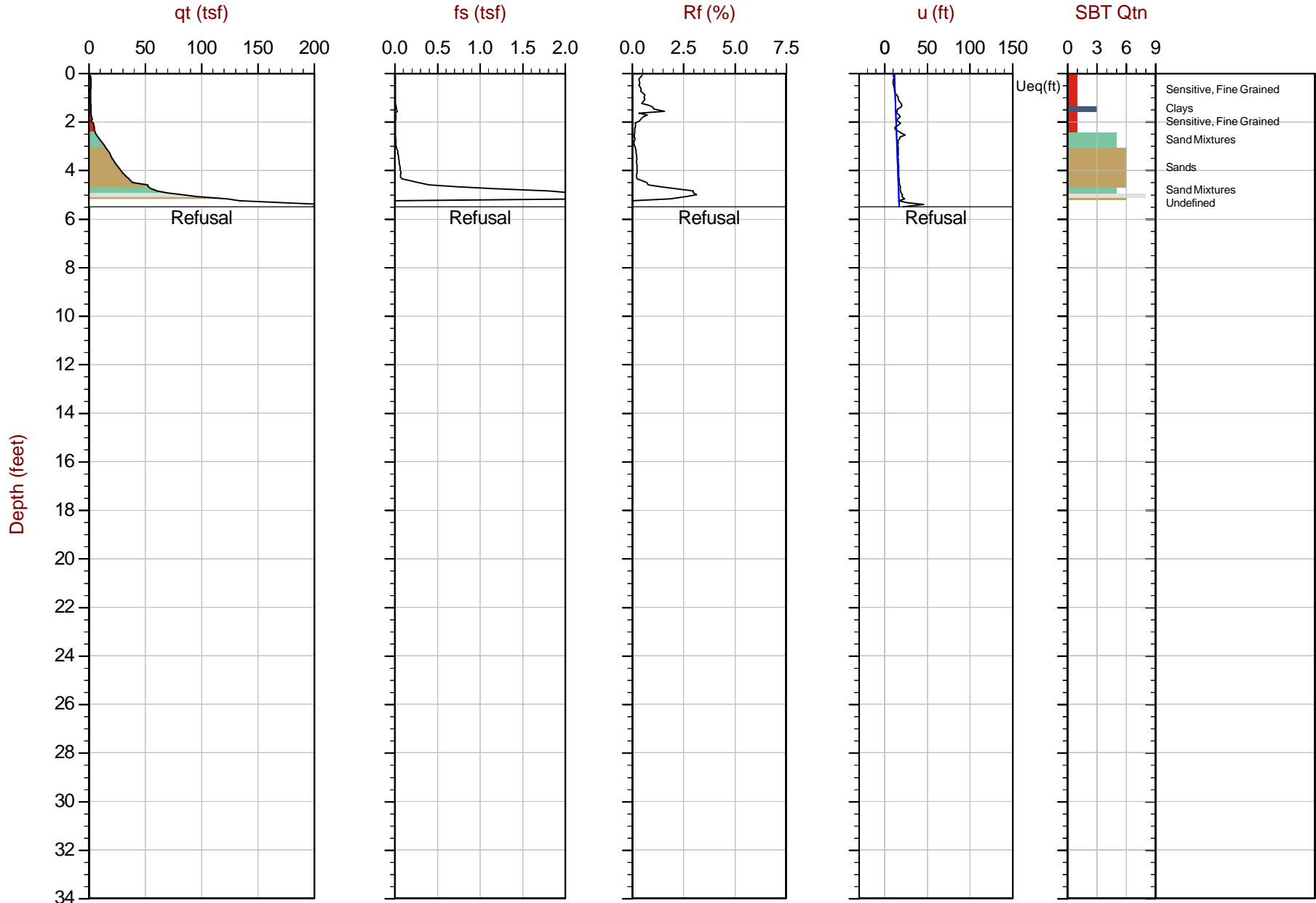
Max Depth: 9.900 m / 32.48 ft  
 Depth Inc: 0.025 m / 0.082 ft  
 Avg Int: Every Point

File: 21-59-22445\_CP49.COR  
 Unit Wt: SBTQtn(PKR2009)

SBT: Robertson, 2009 and 2010  
 Coords: Lat: 47.51235 Long: -122.29820

● Equilibrium Pore Pressure (Ueq)    
 ● Assumed Ueq    
 ◀ Dissipation, Ueq achieved    
 ◀ Dissipation, Ueq not achieved    
 — Hydrostatic Line

The reported coordinates were acquired from hand-held GPS equipment and are only approximate locations. The coordinates should not be used for design purposes.



Max Depth: 1.675 m / 5.50 ft  
 Depth Inc: 0.025 m / 0.082 ft  
 Avg Int: Every Point

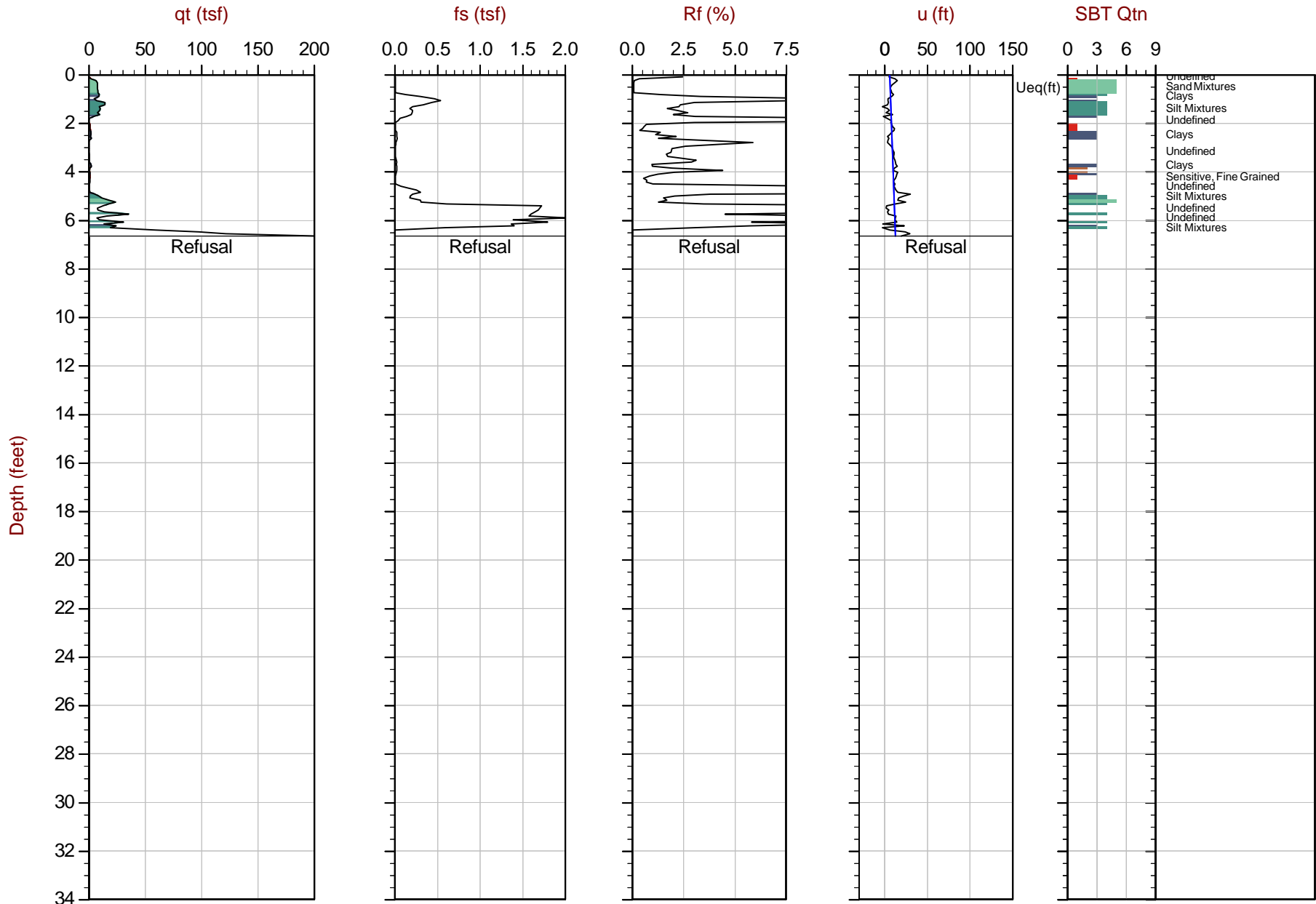
File: 21-59-22445\_CP50.COR  
 Unit Wt: SBTQtn(PKR2009)

SBT: Robertson, 2009 and 2010  
 Coords: Lat: 47.51207 Long: -122.29793

● Equilibrium Pore Pressure (Ueq)    
 ● Assumed Ueq    
 ◀ Dissipation, Ueq achieved    
 ◀ Dissipation, Ueq not achieved    
 — Hydrostatic Line

The reported coordinates were acquired from hand-held GPS equipment and are only approximate locations. The coordinates should not be used for design purposes.





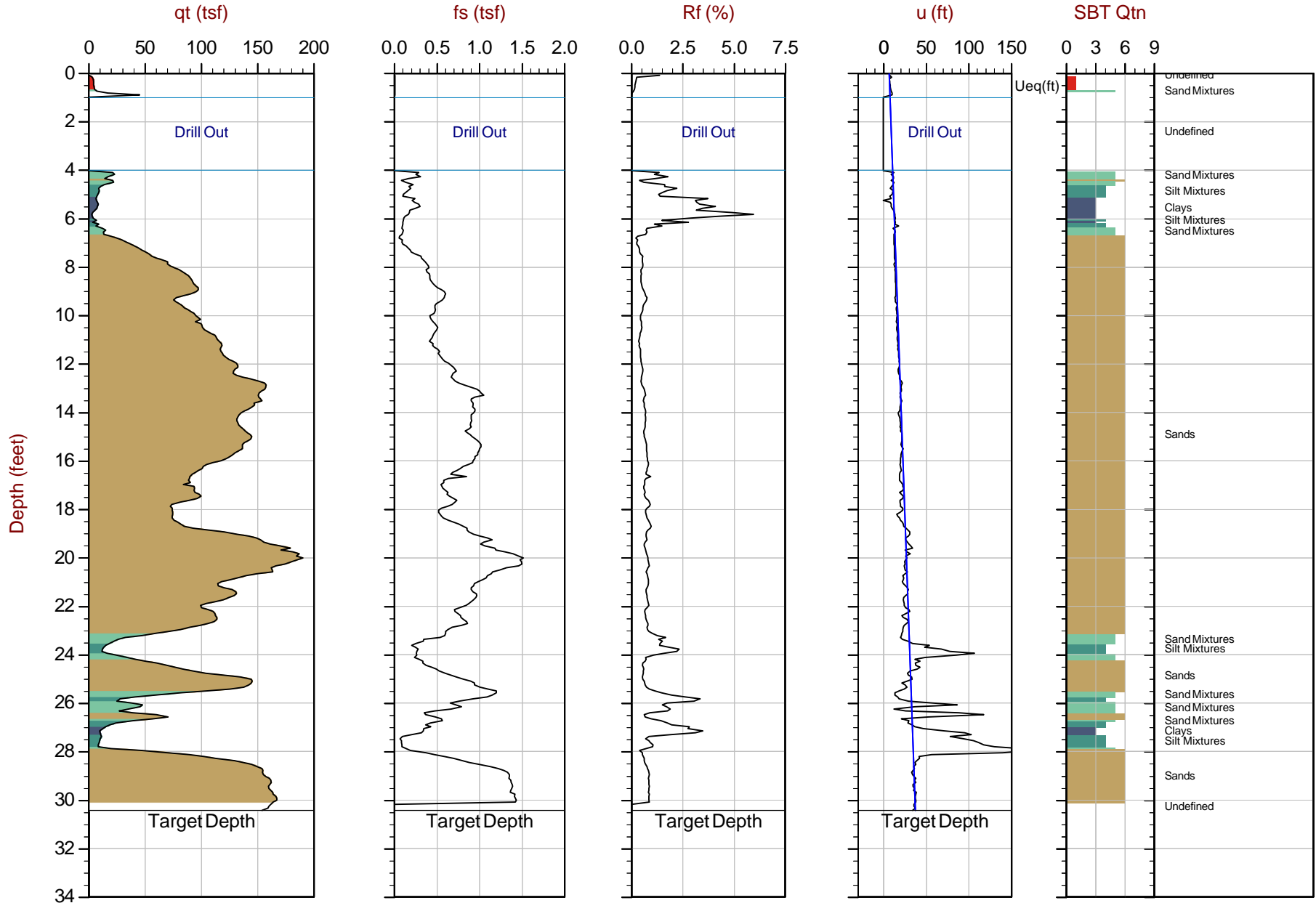
Max Depth: 2.025 m / 6.64 ft  
 Depth Inc: 0.025 m / 0.082 ft  
 Avg Int: Every Point

File: 21-59-22445\_CP51.COR  
 Unit Wt: SBTQtn(PKR2009)

SBT: Robertson, 2009 and 2010  
 Coords: Lat: 47.51218 Long: -122.29794

● Equilibrium Pore Pressure (Ueq)    
 ● Assumed Ueq    
 ◀ Dissipation, Ueq achieved    
 ◀ Dissipation, Ueq not achieved    
 — Hydrostatic Line

The reported coordinates were acquired from hand-held GPS equipment and are only approximate locations. The coordinates should not be used for design purposes.



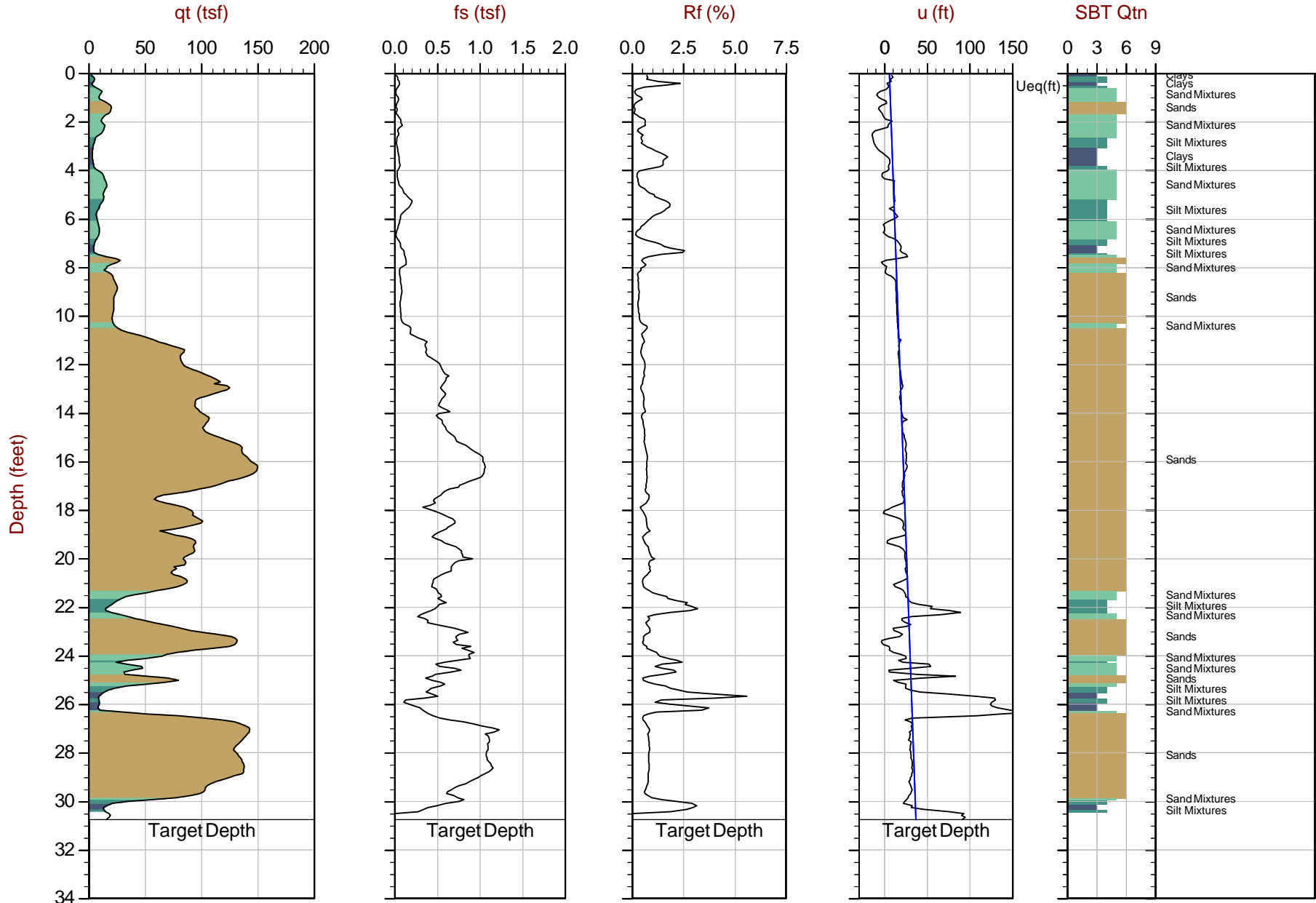
Max Depth: 9.275 m / 30.43 ft  
 Depth Inc: 0.025 m / 0.082 ft  
 Avg Int: Every Point

File: 21-59-22445\_CP52.COR  
 Unit Wt: SBTQtn(PKR2009)

SBT: Robertson, 2009 and 2010  
 Coords: Lat: 47.51211 Long: -122.29774

● Equilibrium Pore Pressure (Ueq)    
 ● Assumed Ueq    
 ◀ Dissipation, Ueq achieved    
 ◀ Dissipation, Ueq not achieved    
 — Hydrostatic Line

The reported coordinates were acquired from hand-held GPS equipment and are only approximate locations. The coordinates should not be used for design purposes.



Max Depth: 9.375 m / 30.76 ft  
 Depth Inc: 0.025 m / 0.082 ft  
 Avg Int: Every Point

File: 21-59-22445\_CP54.COR  
 Unit Wt: SBTQtn(PKR2009)

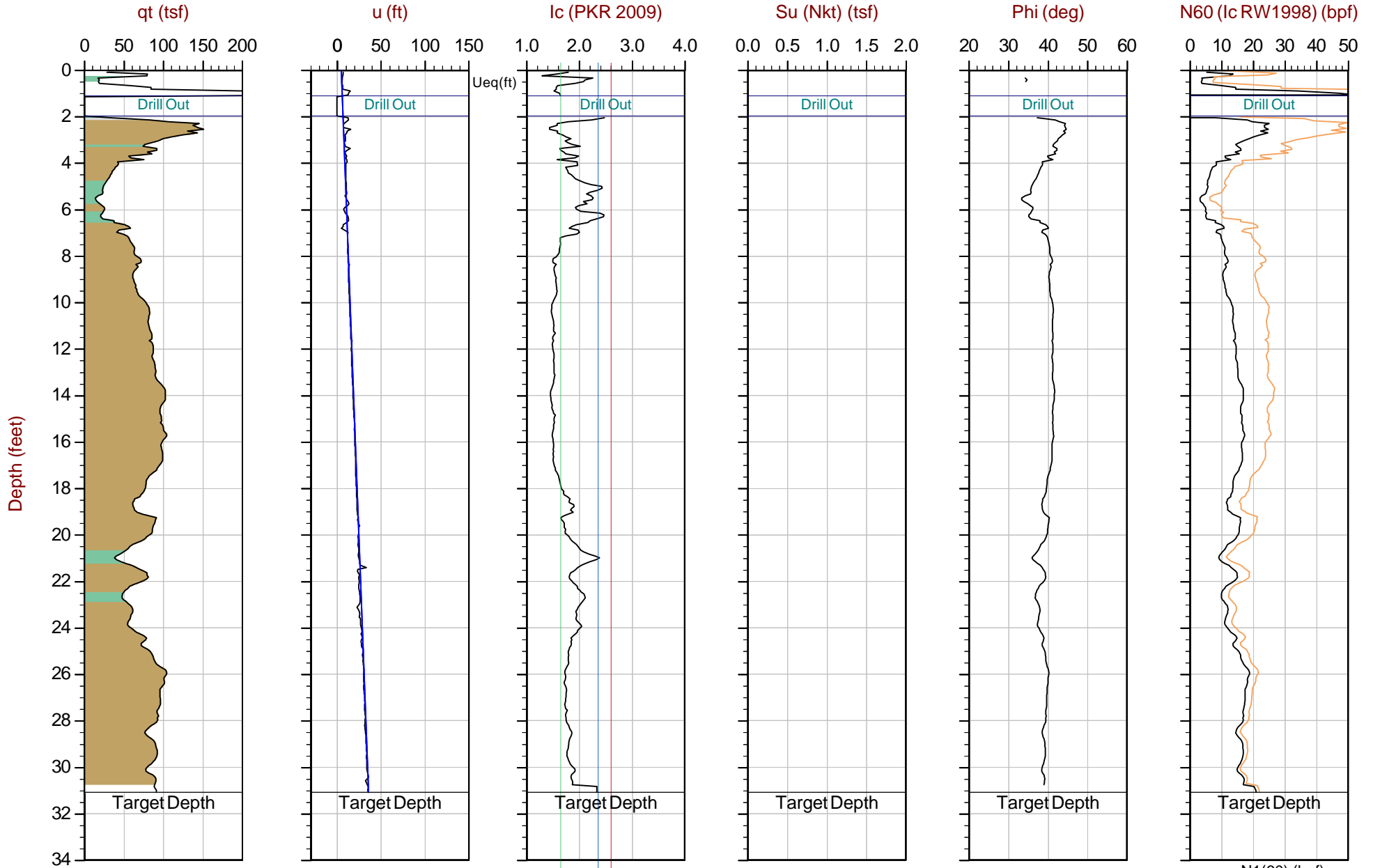
SBT: Robertson, 2009 and 2010  
 Coords: Lat: 47.51197 Long: -122.29758

● Equilibrium Pore Pressure (Ueq)    
 ● Assumed Ueq    
 ◀ Dissipation, Ueq achieved    
 ◀ Dissipation, Ueq not achieved    
 — Hydrostatic Line

The reported coordinates were acquired from hand-held GPS equipment and are only approximate locations. The coordinates should not be used for design purposes.

Advanced Cone Penetration Test Plots with  $I_c$ ,  $S_u$ ,  $\Phi$  and  $N(60)/N1(60)$





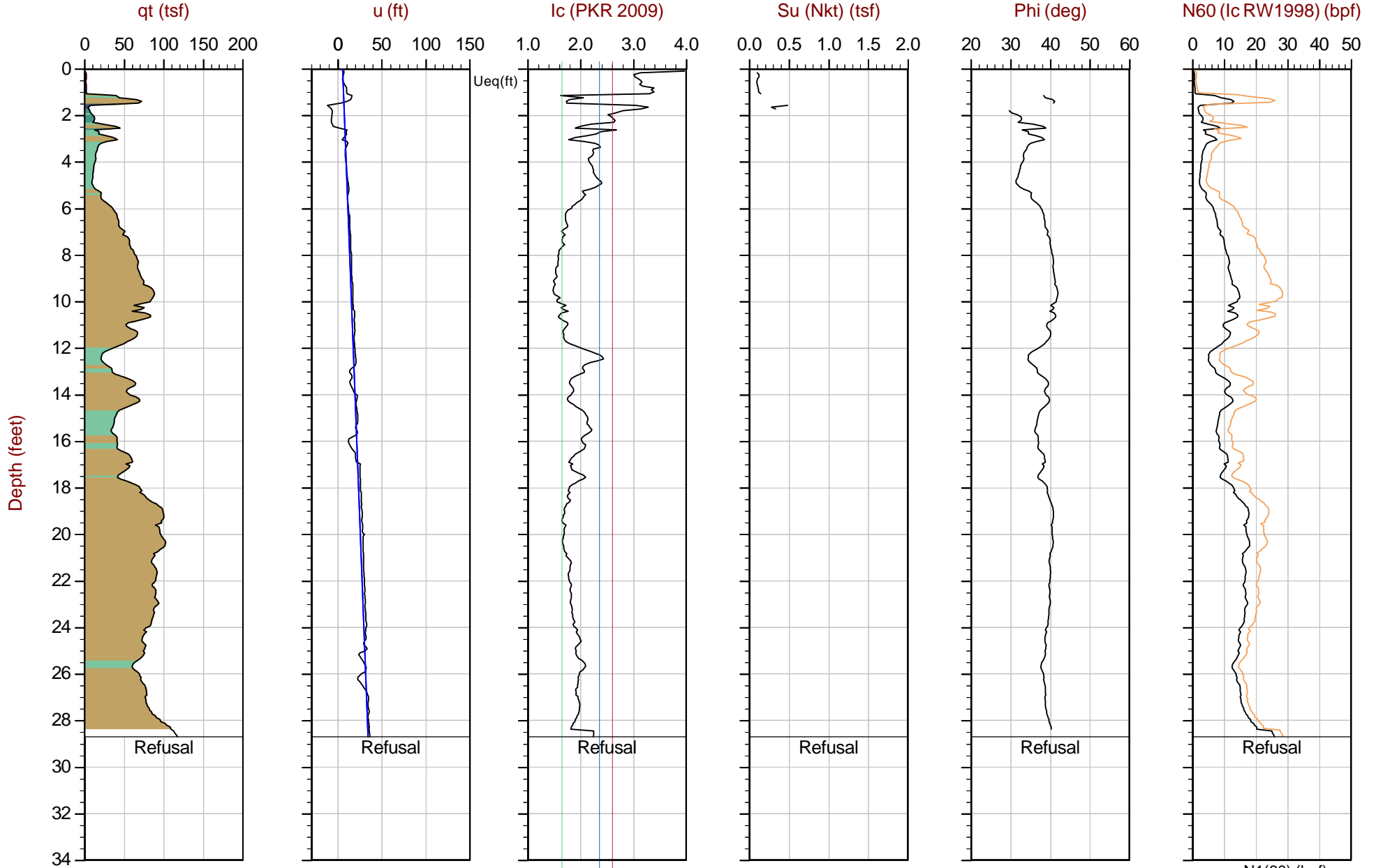
Max Depth: 9.475 m / 31.09 ft  
 Depth Inc: 0.025 m / 0.082 ft  
 Avg Int: Every Point

File: 21-59-22445\_CP06.COR  
 Unit Wt: SBTQtn(PKR2009)  
 Su Nkt: 15.0

SBT: Robertson, 2009 and 2010  
 Coords: Lat: 47.52892 Long: -122.31483

● Equilibrium Pore Pressure (Ueq)    
 ● Assumed Ueq    
 ◀ Dissipation, Ueq achieved    
 ◀ Dissipation, Ueq not achieved    
 — Hydrostatic Line

The reported coordinates were acquired from hand-held GPS equipment and are only approximate locations. The coordinates should not be used for design purposes.



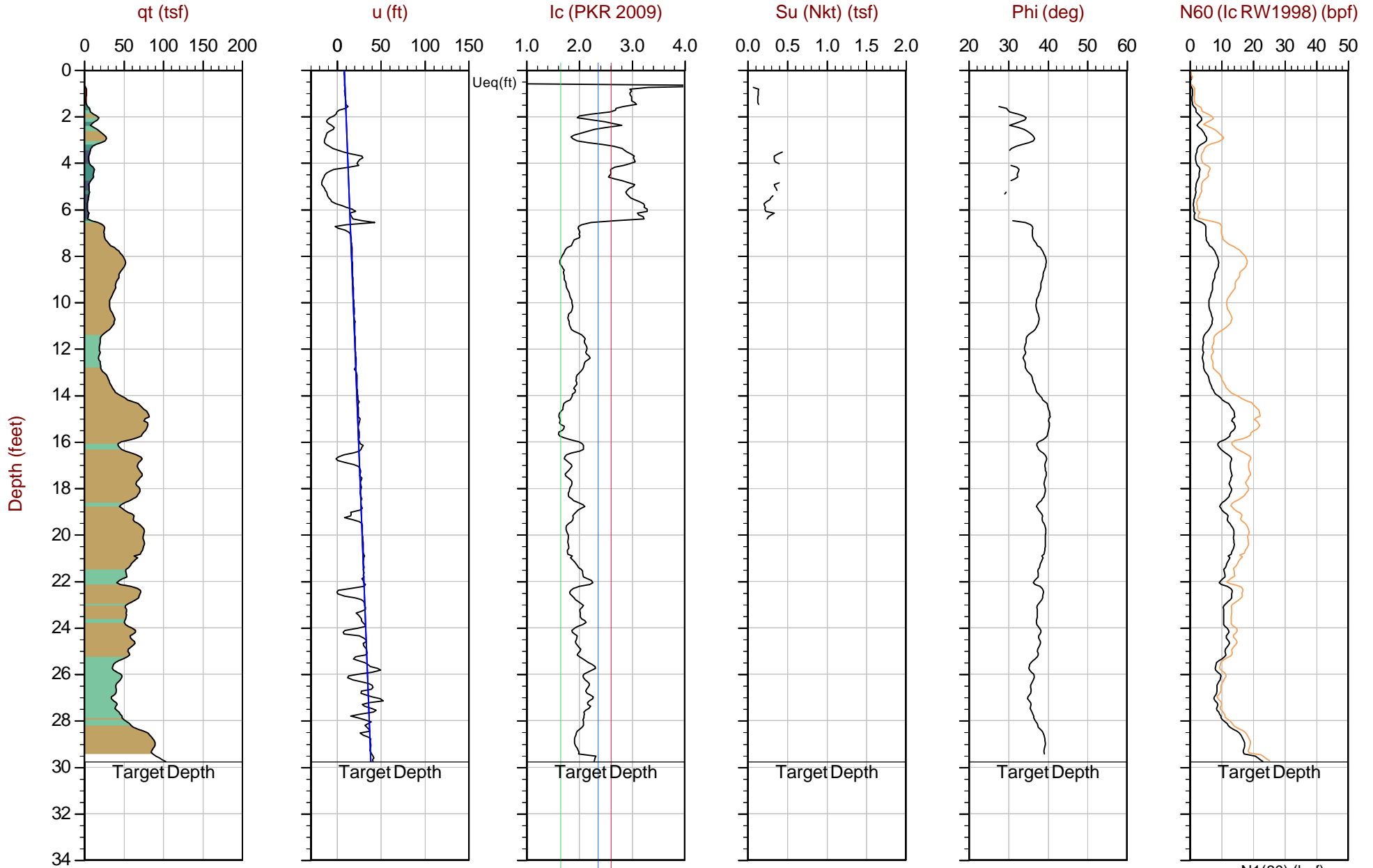
Max Depth: 8.750 m / 28.71 ft  
 Depth Inc: 0.025 m / 0.082 ft  
 Avg Int: Every Point

File: 21-59-22445\_CP14.COR  
 Unit Wt: SBTQtn(PKR2009)  
 Su Nkt: 15.0

SBT: Robertson, 2009 and 2010  
 Coords: Lat: 47.52477 Long: -122.30819

● Equilibrium Pore Pressure (Ueq)    
 ● Assumed Ueq    
 ◀ Dissipation, Ueq achieved    
 ◀ Dissipation, Ueq not achieved    
 — Hydrostatic Line

The reported coordinates were acquired from hand-held GPS equipment and are only approximate locations. The coordinates should not be used for design purposes.



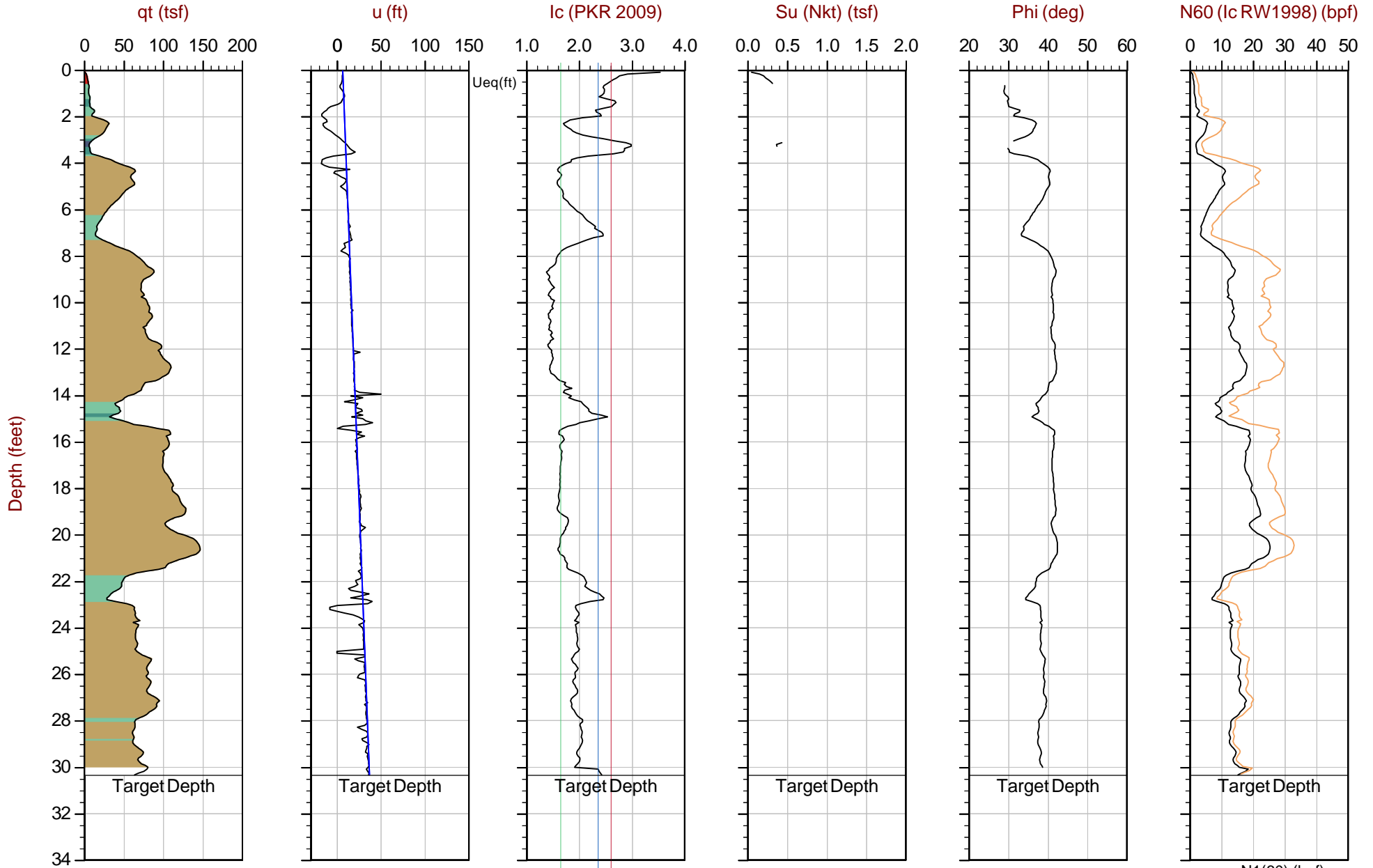
Max Depth: 9.075 m / 29.77 ft  
 Depth Inc: 0.025 m / 0.082 ft  
 Avg Int: Every Point

File: 21-59-22445\_CP16.COR  
 Unit Wt: SBTQtn(PKR2009)  
 Su Nkt: 15.0

SBT: Robertson, 2009 and 2010  
 Coords: Lat: 47.52409 Long: -122.30770

● Equilibrium Pore Pressure (Ueq)    
 ● Assumed Ueq    
 ◀ Dissipation, Ueq achieved    
 ◀ Dissipation, Ueq not achieved    
 — Hydrostatic Line

The reported coordinates were acquired from hand-held GPS equipment and are only approximate locations. The coordinates should not be used for design purposes.



Max Depth: 9.250 m / 30.35 ft  
 Depth Inc: 0.025 m / 0.082 ft  
 Avg Int: Every Point

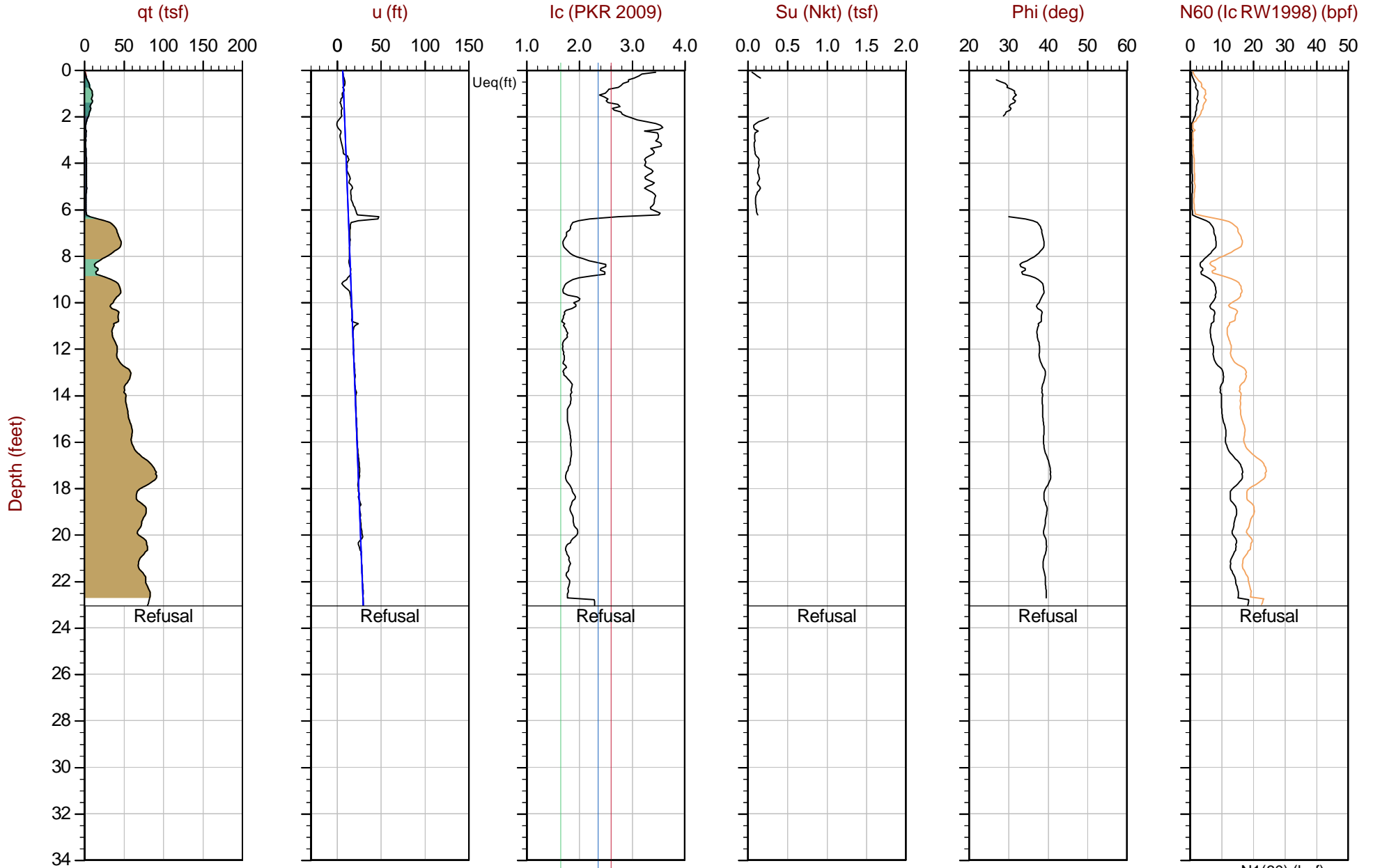
File: 21-59-22445\_CP17.COR  
 Unit Wt: SBTQtn(PKR2009)  
 Su Nkt: 15.0

SBT: Robertson, 2009 and 2010  
 Coords: Lat: N/A Long: N/A

● Equilibrium Pore Pressure (Ueq)    
 ● Assumed Ueq    
 ◀ Dissipation, Ueq achieved    
 ◀ Dissipation, Ueq not achieved    
 — Hydrostatic Line

The reported coordinates were acquired from hand-held GPS equipment and are only approximate locations. The coordinates should not be used for design purposes.





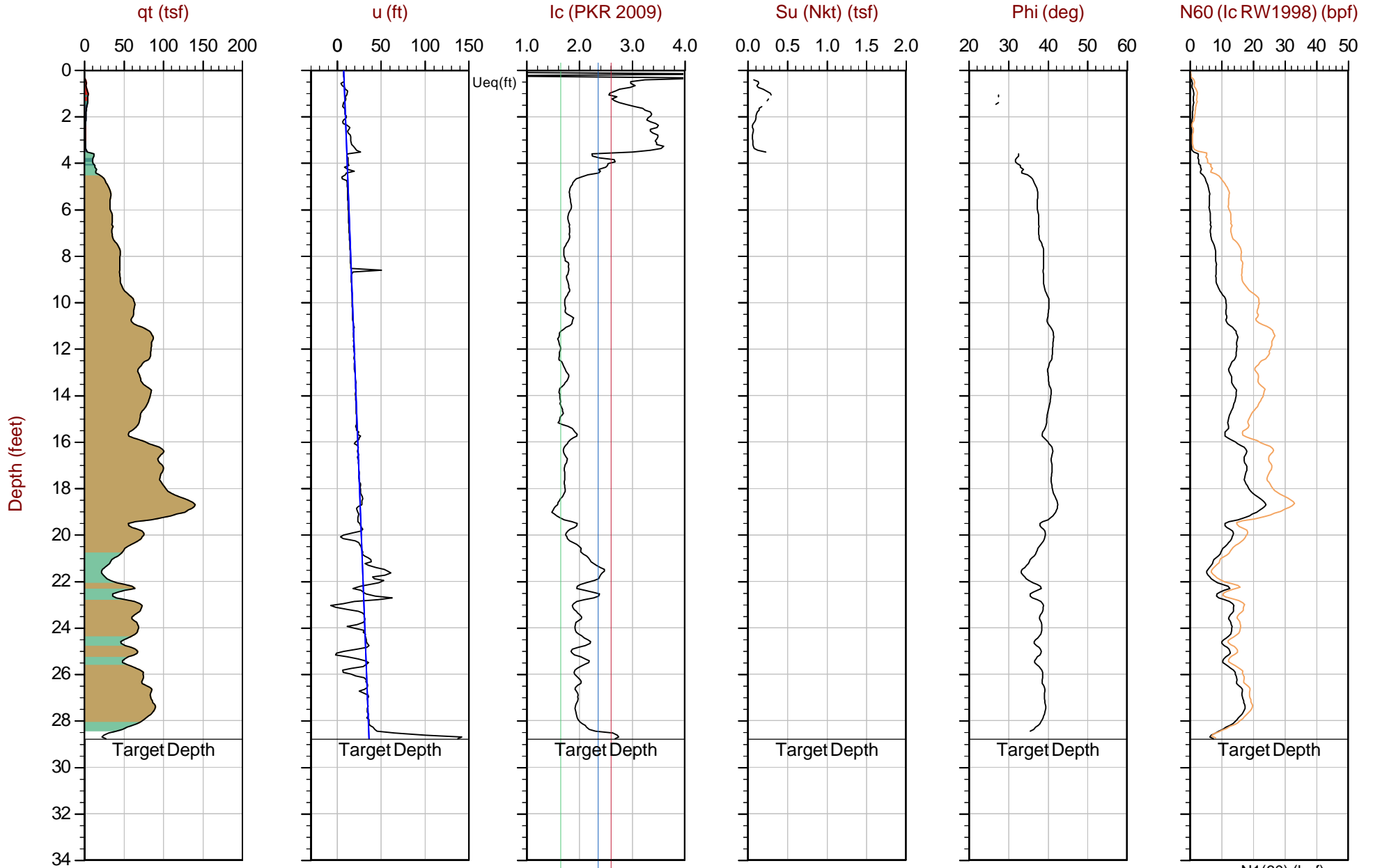
Max Depth: 7.025 m / 23.05 ft  
 Depth Inc: 0.025 m / 0.082 ft  
 Avg Int: Every Point

File: 21-59-22445\_CP20.COR  
 Unit Wt: SBTQtn(PKR2009)  
 Su Nkt: 15.0

SBT: Robertson, 2009 and 2010  
 Coords: Lat: N/A Long: N/A

● Equilibrium Pore Pressure (Ueq)    
 ● Assumed Ueq    
 ◀ Dissipation, Ueq achieved    
 ◀ Dissipation, Ueq not achieved    
 — Hydrostatic Line

The reported coordinates were acquired from hand-held GPS equipment and are only approximate locations. The coordinates should not be used for design purposes.



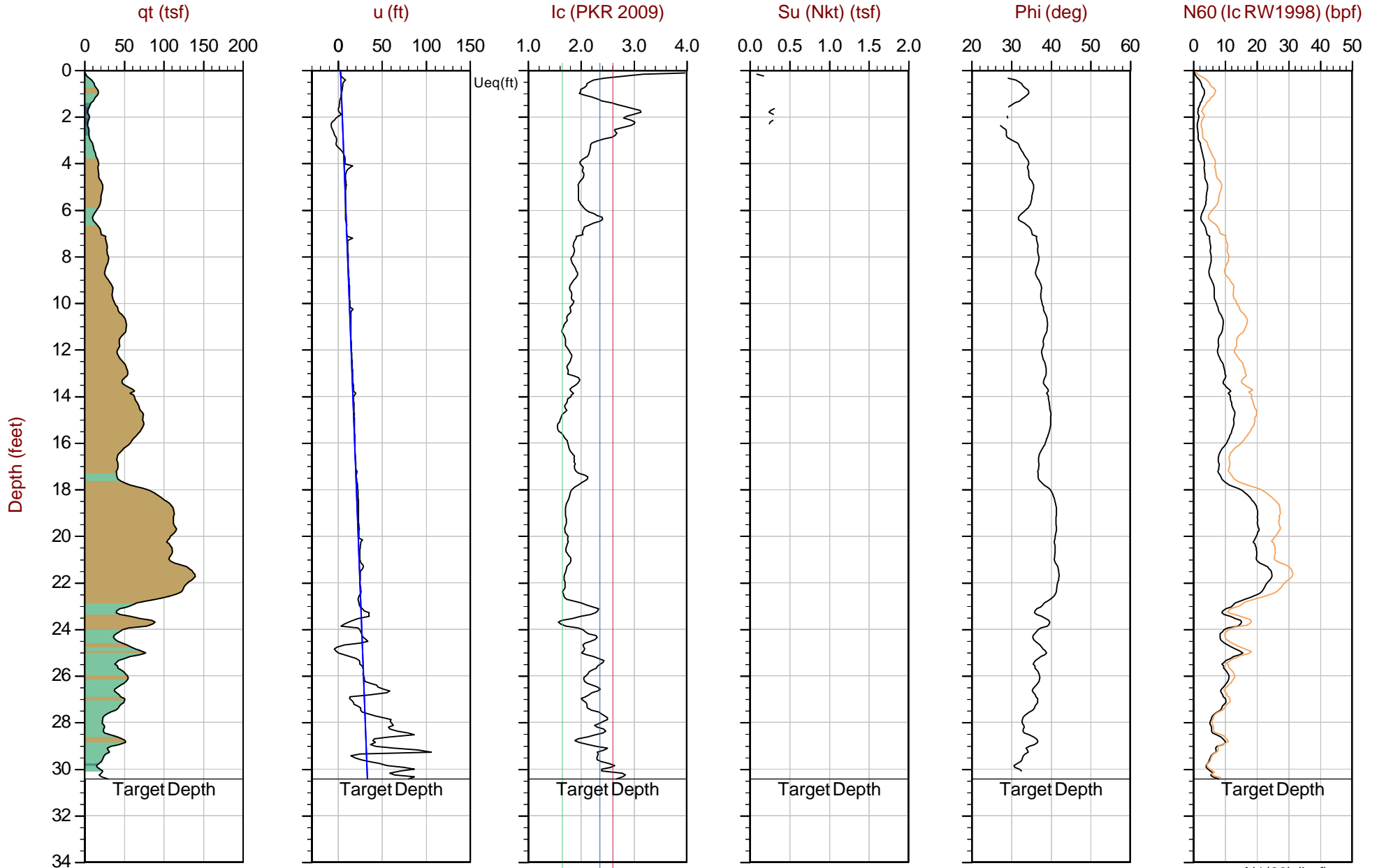
Max Depth: 8.775 m / 28.79 ft  
 Depth Inc: 0.025 m / 0.082 ft  
 Avg Int: Every Point

File: 21-59-22445\_CP22.COR  
 Unit Wt: SBTQtn(PKR2009)  
 Su Nkt: 15.0

SBT: Robertson, 2009 and 2010  
 Coords: Lat: N/A Long: N/A

● Equilibrium Pore Pressure (Ueq)    
 ● Assumed Ueq    
 ◀ Dissipation, Ueq achieved    
 ◀ Dissipation, Ueq not achieved    
 — Hydrostatic Line

The reported coordinates were acquired from hand-held GPS equipment and are only approximate locations. The coordinates should not be used for design purposes.



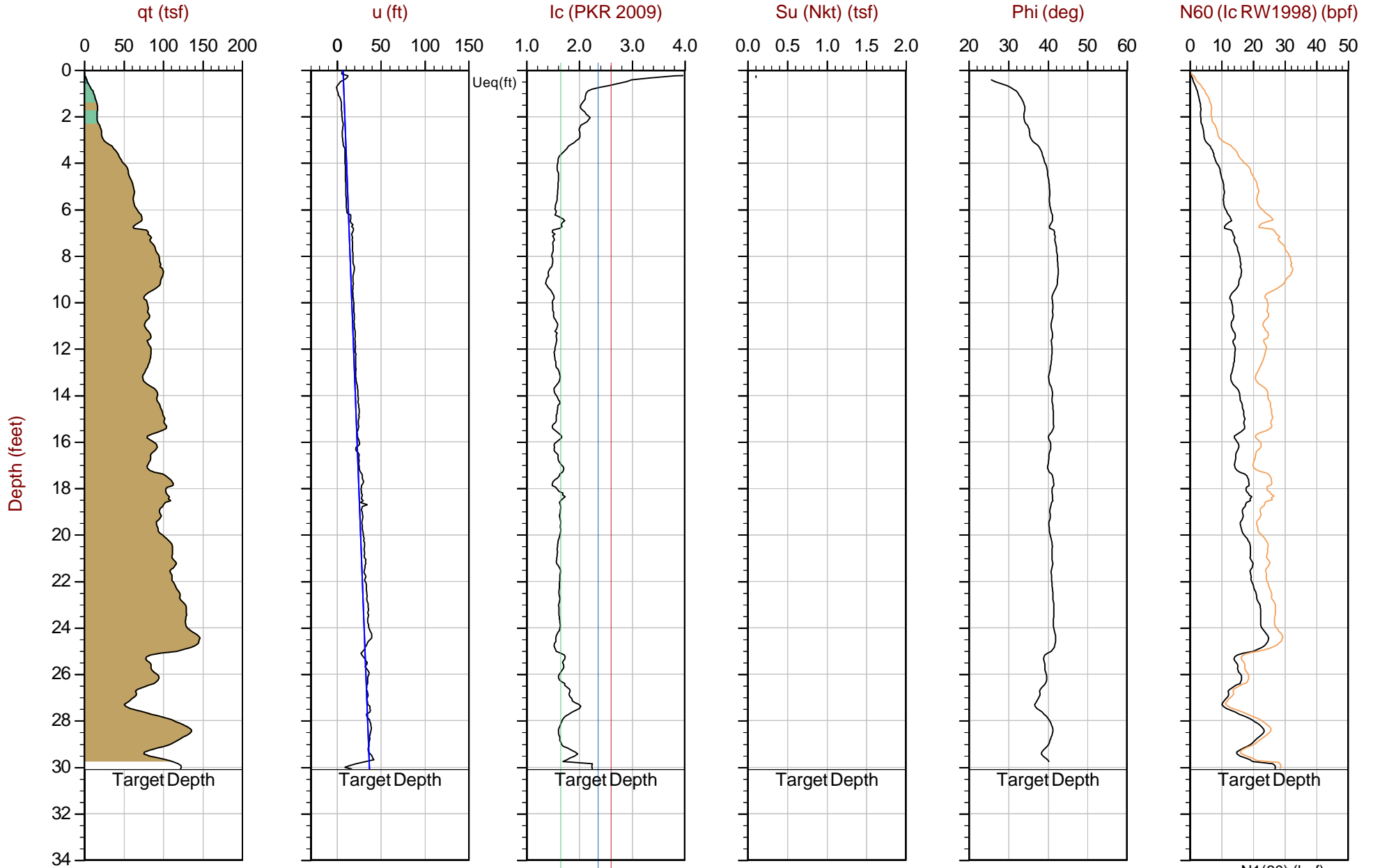
Max Depth: 9.275 m / 30.43 ft  
 Depth Inc: 0.025 m / 0.082 ft  
 Avg Int: Every Point

File: 21-59-22445\_CP27.COR  
 Unit Wt: SBTQtn(PKR2009)  
 Su Nkt: 15.0

SBT: Robertson, 2009 and 2010  
 Coords: Lat: N/A Long: N/A

● Equilibrium Pore Pressure (Ueq)    
 ● Assumed Ueq    
 ◀ Dissipation, Ueq achieved    
 ◀ Dissipation, Ueq not achieved    
 — Hydrostatic Line

The reported coordinates were acquired from hand-held GPS equipment and are only approximate locations. The coordinates should not be used for design purposes.



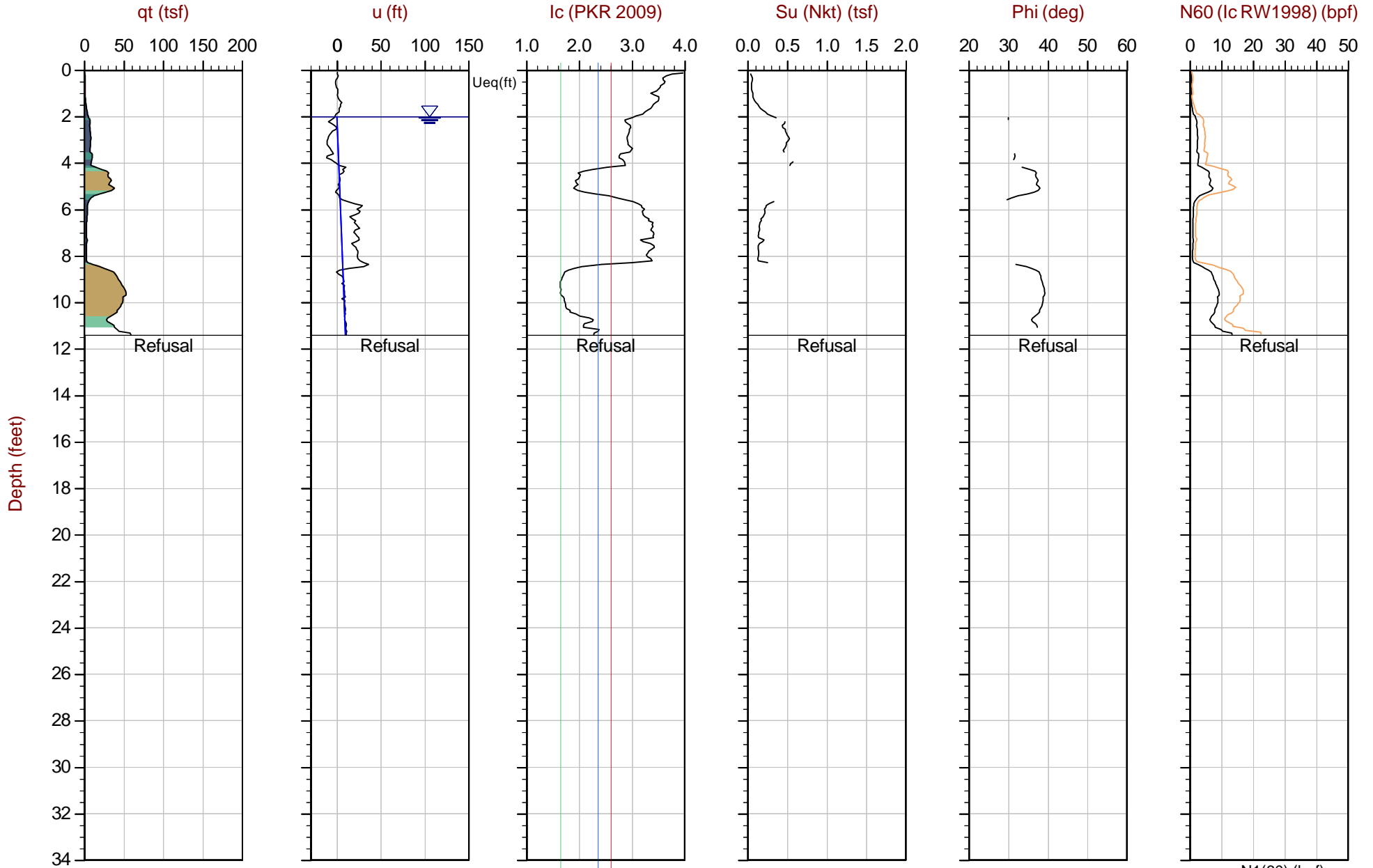
Max Depth: 9.175 m / 30.10 ft  
 Depth Inc: 0.025 m / 0.082 ft  
 Avg Int: Every Point

File: 21-59-22445\_CP30.COR  
 Unit Wt: SBTQtn(PKR2009)  
 Su Nkt: 15.0

SBT: Robertson, 2009 and 2010  
 Coords: Lat: 47.52066 Long: -122.30558

● Equilibrium Pore Pressure (Ueq)    
 ● Assumed Ueq    
 ◀ Dissipation, Ueq achieved    
 ◀ Dissipation, Ueq not achieved    
 — Hydrostatic Line

The reported coordinates were acquired from hand-held GPS equipment and are only approximate locations. The coordinates should not be used for design purposes.



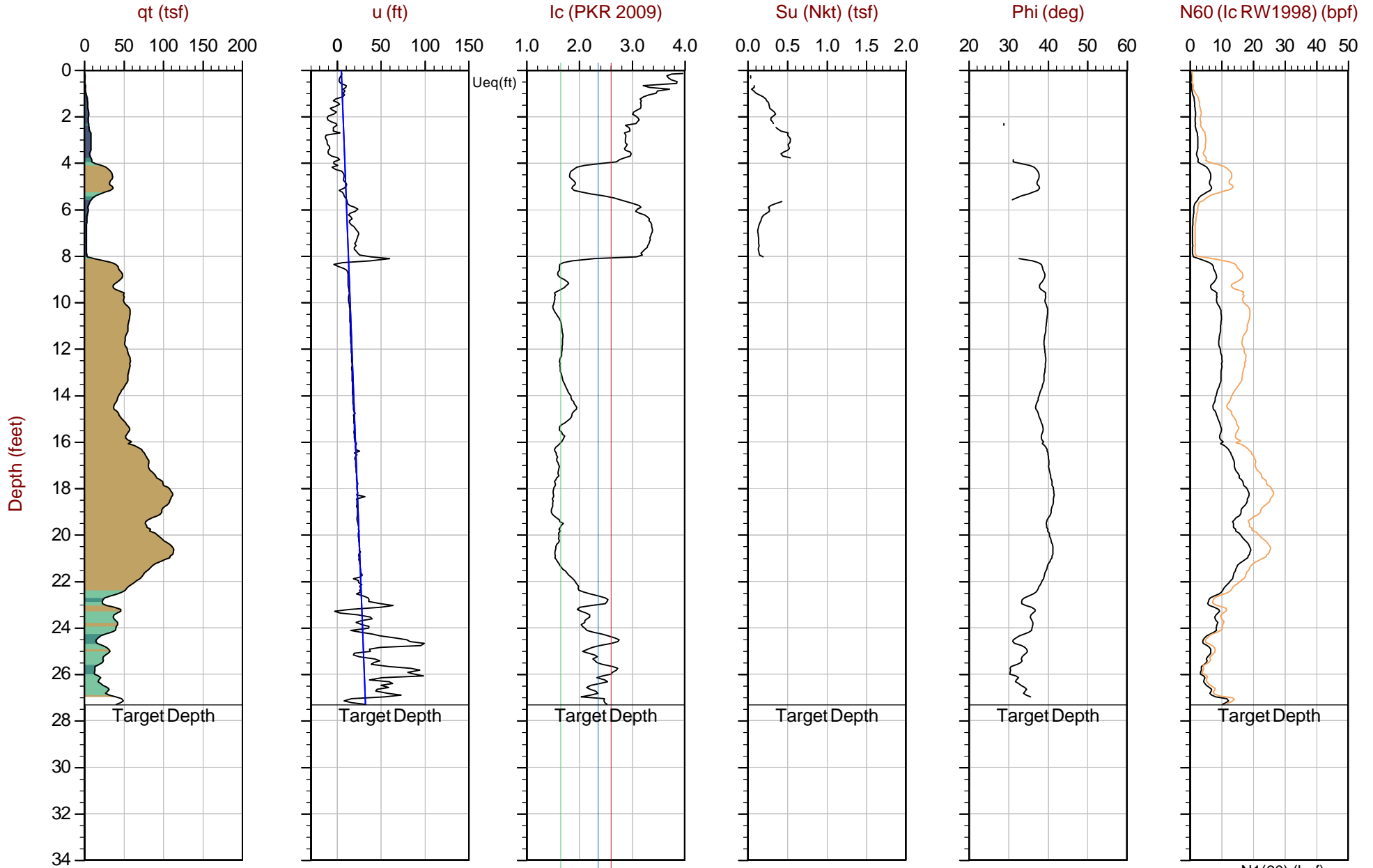
Max Depth: 3.475 m / 11.40 ft  
 Depth Inc: 0.025 m / 0.082 ft  
 Avg Int: Every Point

File: 21-59-22445\_CP31.COR  
 Unit Wt: SBTQtn(PKR2009)  
 Su Nkt: 15.0

SBT: Robertson, 2009 and 2010  
 Coords: Lat: N/A Long: N/A

● Equilibrium Pore Pressure (Ueq)    
 ● Assumed Ueq    
 ◀ Dissipation, Ueq achieved    
 ◀ Dissipation, Ueq not achieved    
 — Hydrostatic Line

The reported coordinates were acquired from hand-held GPS equipment and are only approximate locations. The coordinates should not be used for design purposes.



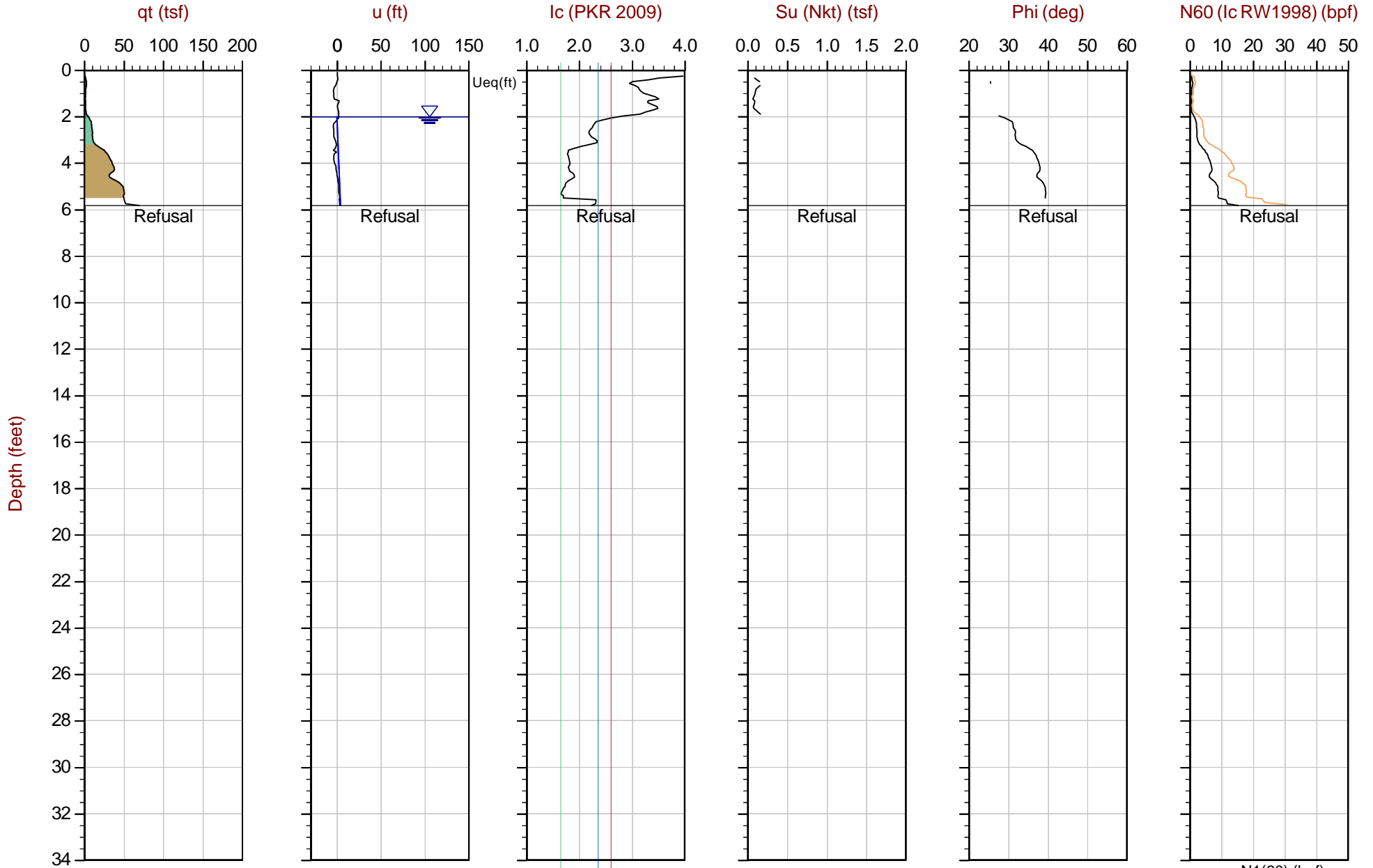
Max Depth: 8.325 m / 27.31 ft  
 Depth Inc: 0.025 m / 0.082 ft  
 Avg Int: Every Point

File: 21-59-22445\_CP31B.COR  
 Unit Wt: SBTQtn(PKR2009)  
 Su Nkt: 15.0

SBT: Robertson, 2009 and 2010  
 Coords: Lat: N/A Long: N/A

● Equilibrium Pore Pressure (Ueq)    
 ● Assumed Ueq    
 ◀ Dissipation, Ueq achieved    
 ◀ Dissipation, Ueq not achieved    
 — Hydrostatic Line

The reported coordinates were acquired from hand-held GPS equipment and are only approximate locations. The coordinates should not be used for design purposes.



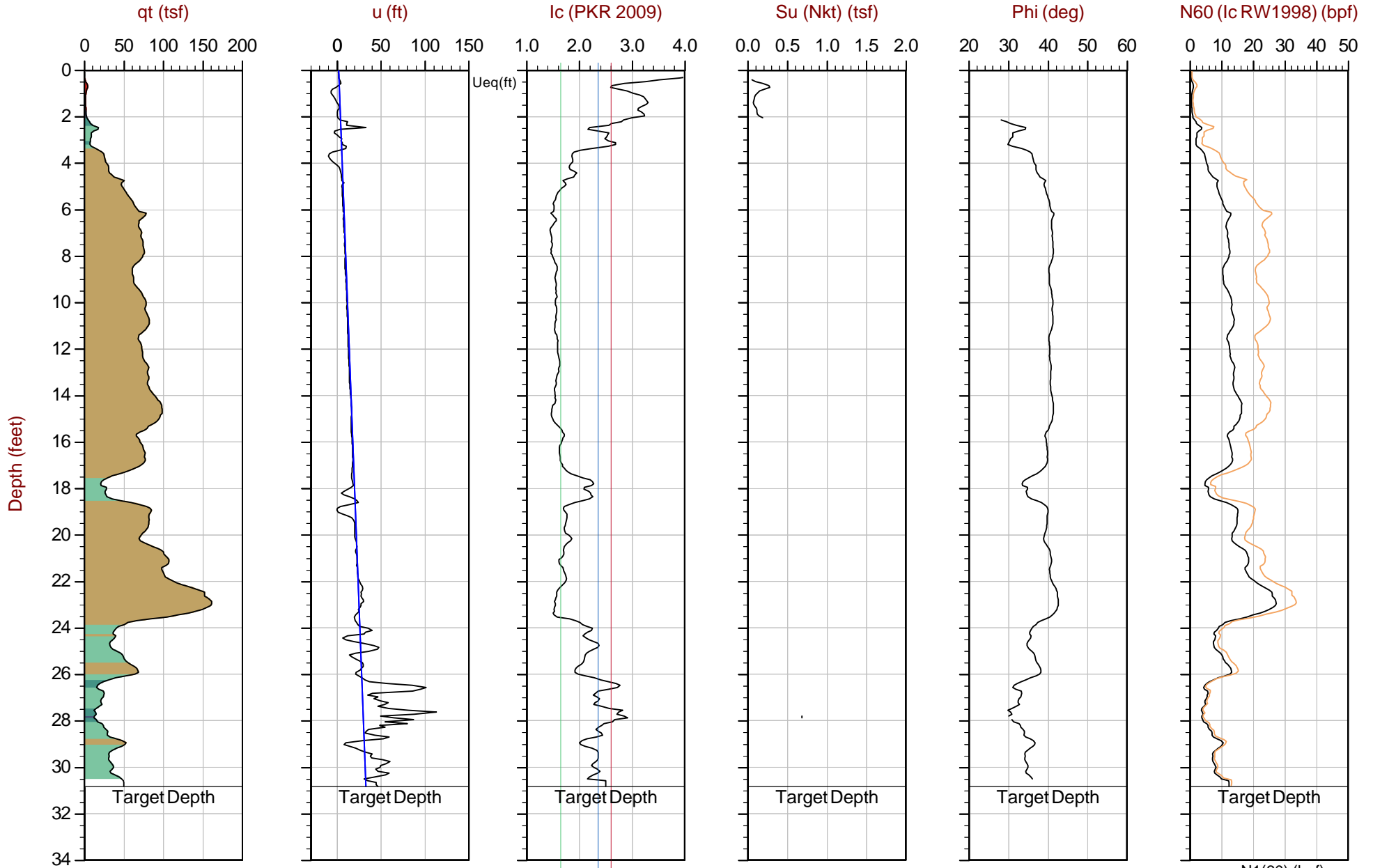
Max Depth: 1.775 m / 5.82 ft  
 Depth Inc: 0.025 m / 0.082 ft  
 Avg Int: Every Point

File: 21-59-22445\_CP32.COR  
 Unit Wt: SBTQtn(PKR2009)  
 Su Nkt: 15.0

SBT: Robertson, 2009 and 2010  
 Coords: Lat: 47.52028 Long: -122.30553

● Equilibrium Pore Pressure (Ueq)    
 ● Assumed Ueq    
 ◀ Dissipation, Ueq achieved    
 ◀ Dissipation, Ueq not achieved    
 — Hydrostatic Line

The reported coordinates were acquired from hand-held GPS equipment and are only approximate locations. The coordinates should not be used for design purposes.



Max Depth: 9.400 m / 30.84 ft  
 Depth Inc: 0.025 m / 0.082 ft  
 Avg Int: Every Point

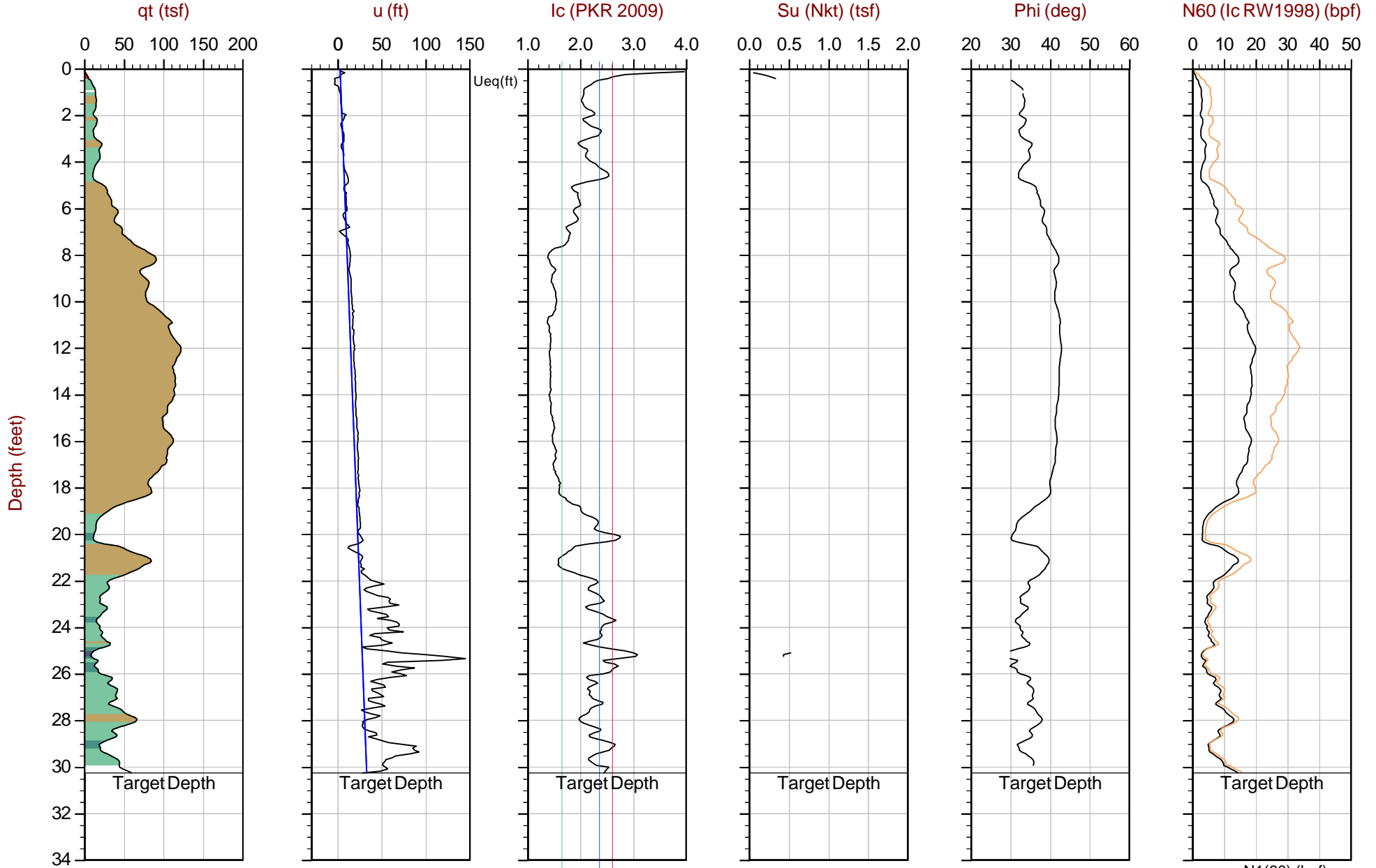
File: 21-59-22445\_CP32B.COR  
 Unit Wt: SBTQtn(PKR2009)  
 Su Nkt: 15.0

SBT: Robertson, 2009 and 2010  
 Coords: Lat: 47.52030 Long: -122.30555

● Equilibrium Pore Pressure (Ueq)    
 ● Assumed Ueq    
 ◀ Dissipation, Ueq achieved    
 ◀ Dissipation, Ueq not achieved    
 — Hydrostatic Line

The reported coordinates were acquired from hand-held GPS equipment and are only approximate locations. The coordinates should not be used for design purposes.





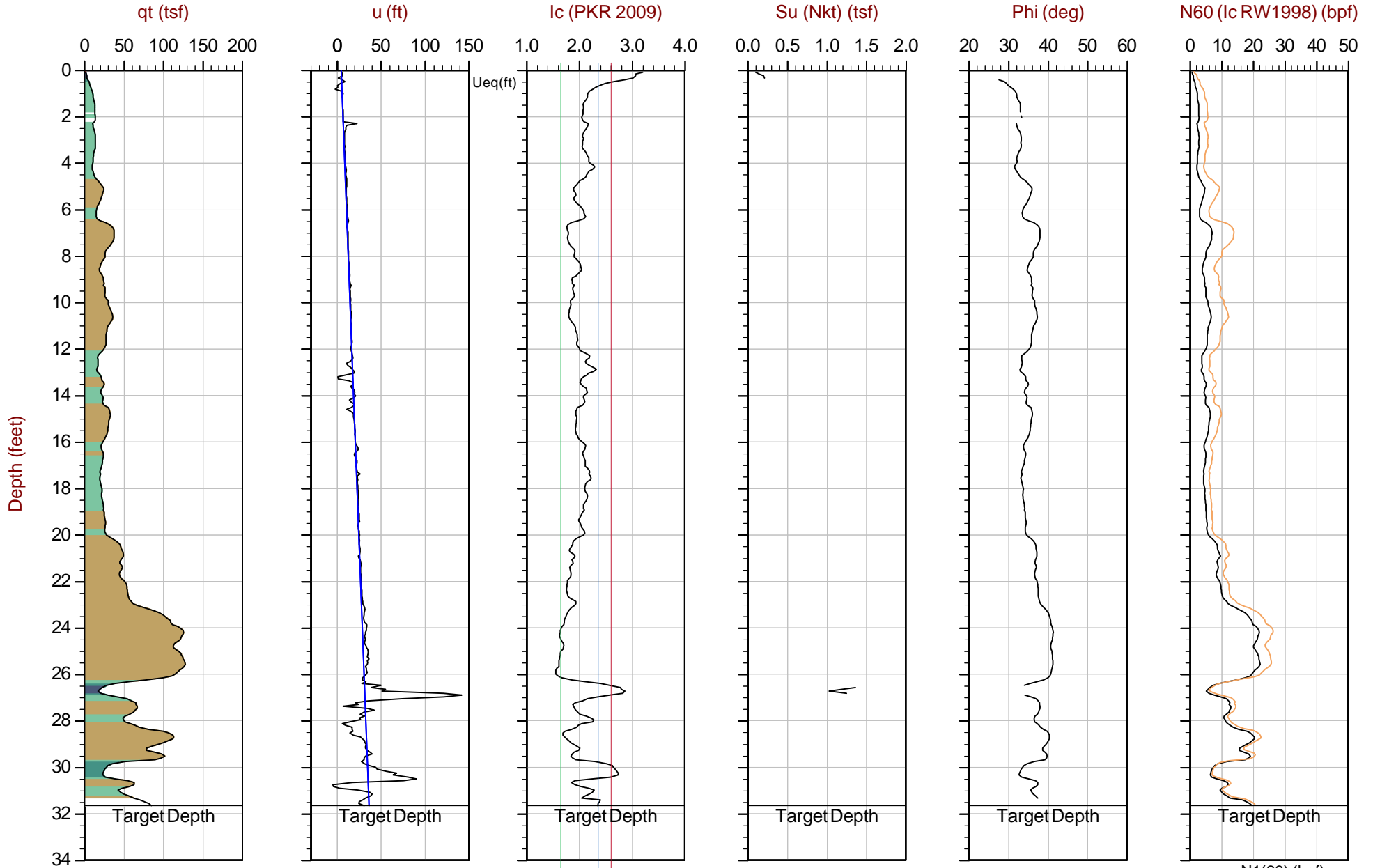
Max Depth: 9.225 m / 30.27 ft  
 Depth Inc: 0.025 m / 0.082 ft  
 Avg Int: Every Point

File: 21-59-22445\_CP34.COR  
 Unit Wt: SBTQtn(PKR2009)  
 Su Nkt: 15.0

SBT: Robertson, 2009 and 2010  
 Coords: Lat: 47.51986 Long: -122.30540

● Equilibrium Pore Pressure (Ueq)    
 ● Assumed Ueq    
 ◀ Dissipation, Ueq achieved    
 ◀ Dissipation, Ueq not achieved    
 — Hydrostatic Line

The reported coordinates were acquired from hand-held GPS equipment and are only approximate locations. The coordinates should not be used for design purposes.



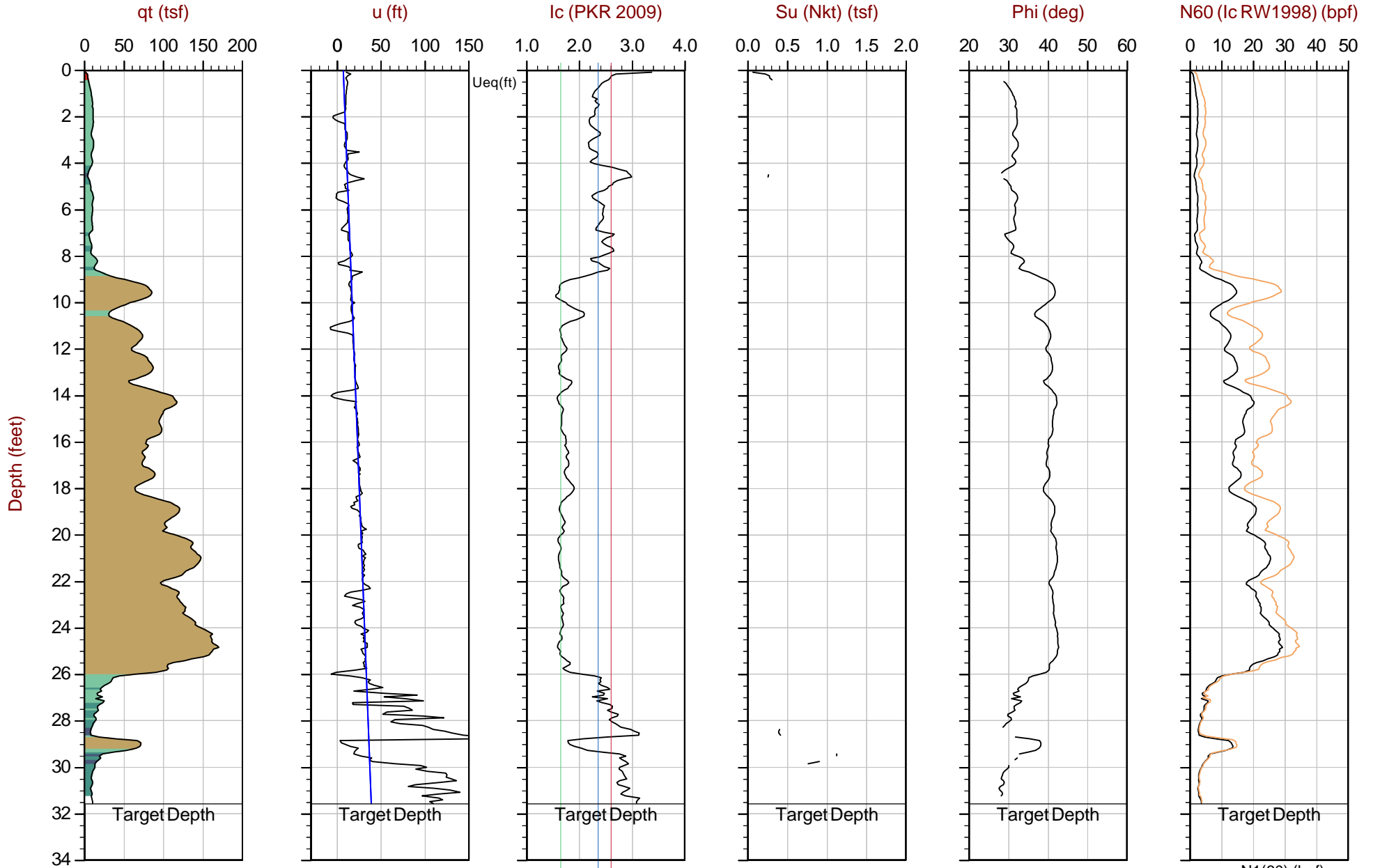
Max Depth: 9.650 m / 31.66 ft  
 Depth Inc: 0.025 m / 0.082 ft  
 Avg Int: Every Point

File: 21-59-22445\_CP40.COR  
 Unit Wt: SBTQtn(PKR2009)  
 Su Nkt: 15.0

SBT: Robertson, 2009 and 2010  
 Coords: Lat: 47.51155 Long: -122.30247

● Equilibrium Pore Pressure (Ueq)    
 ● Assumed Ueq    
 ◀ Dissipation, Ueq achieved    
 ◀ Dissipation, Ueq not achieved    
 — Hydrostatic Line

The reported coordinates were acquired from hand-held GPS equipment and are only approximate locations. The coordinates should not be used for design purposes.



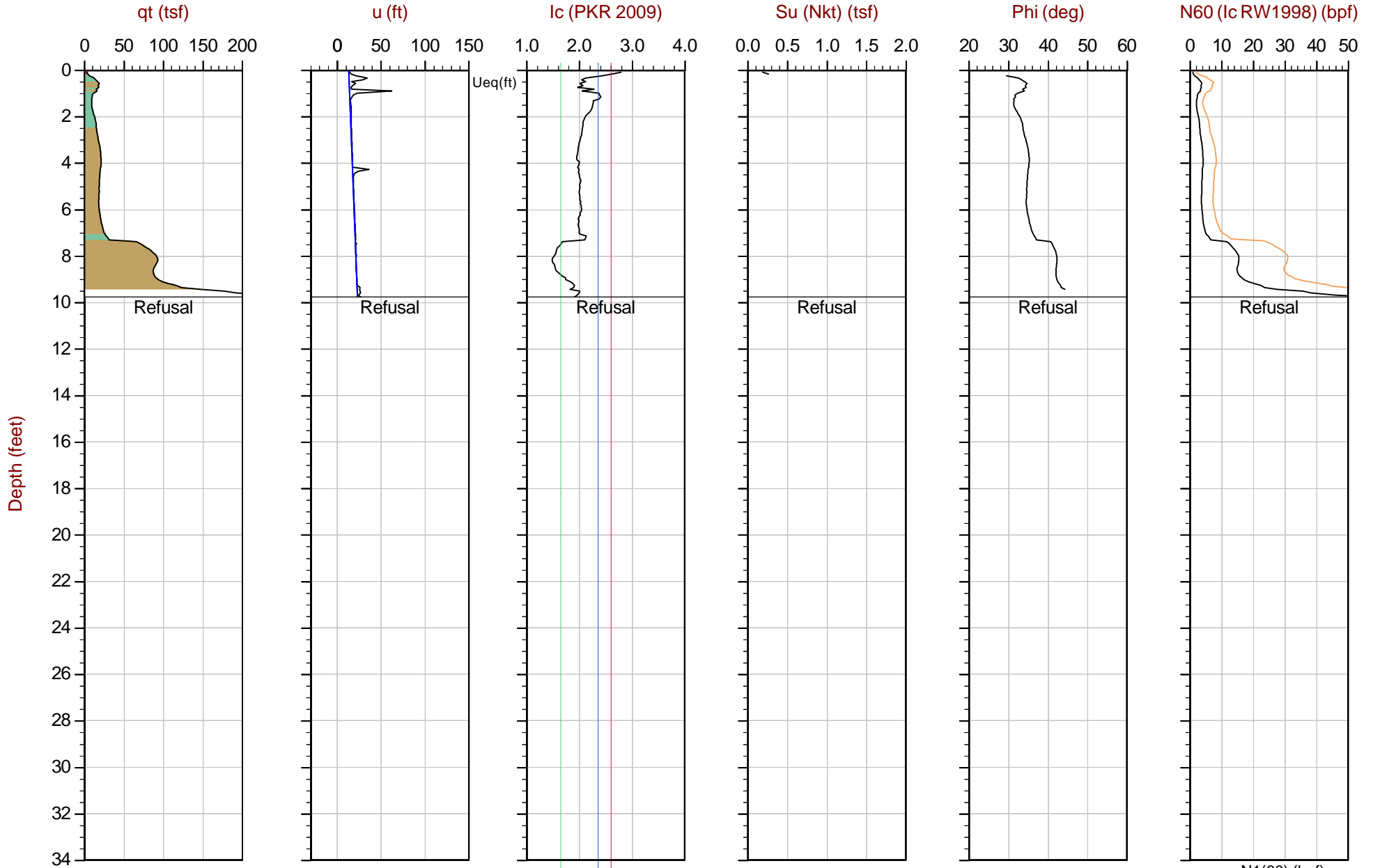
Max Depth: 9.625 m / 31.58 ft  
 Depth Inc: 0.025 m / 0.082 ft  
 Avg Int: Every Point

File: 21-59-22445\_CP45.COR  
 Unit Wt: SBTQn(PKR2009)  
 Su Nkt: 15.0

SBT: Robertson, 2009 and 2010  
 Coords: Lat: 47.51253 Long: -122.29899

● Equilibrium Pore Pressure (Ueq)    
 ● Assumed Ueq    
 ◀ Dissipation, Ueq achieved    
 ◀ Dissipation, Ueq not achieved    
 — Hydrostatic Line

The reported coordinates were acquired from hand-held GPS equipment and are only approximate locations. The coordinates should not be used for design purposes.



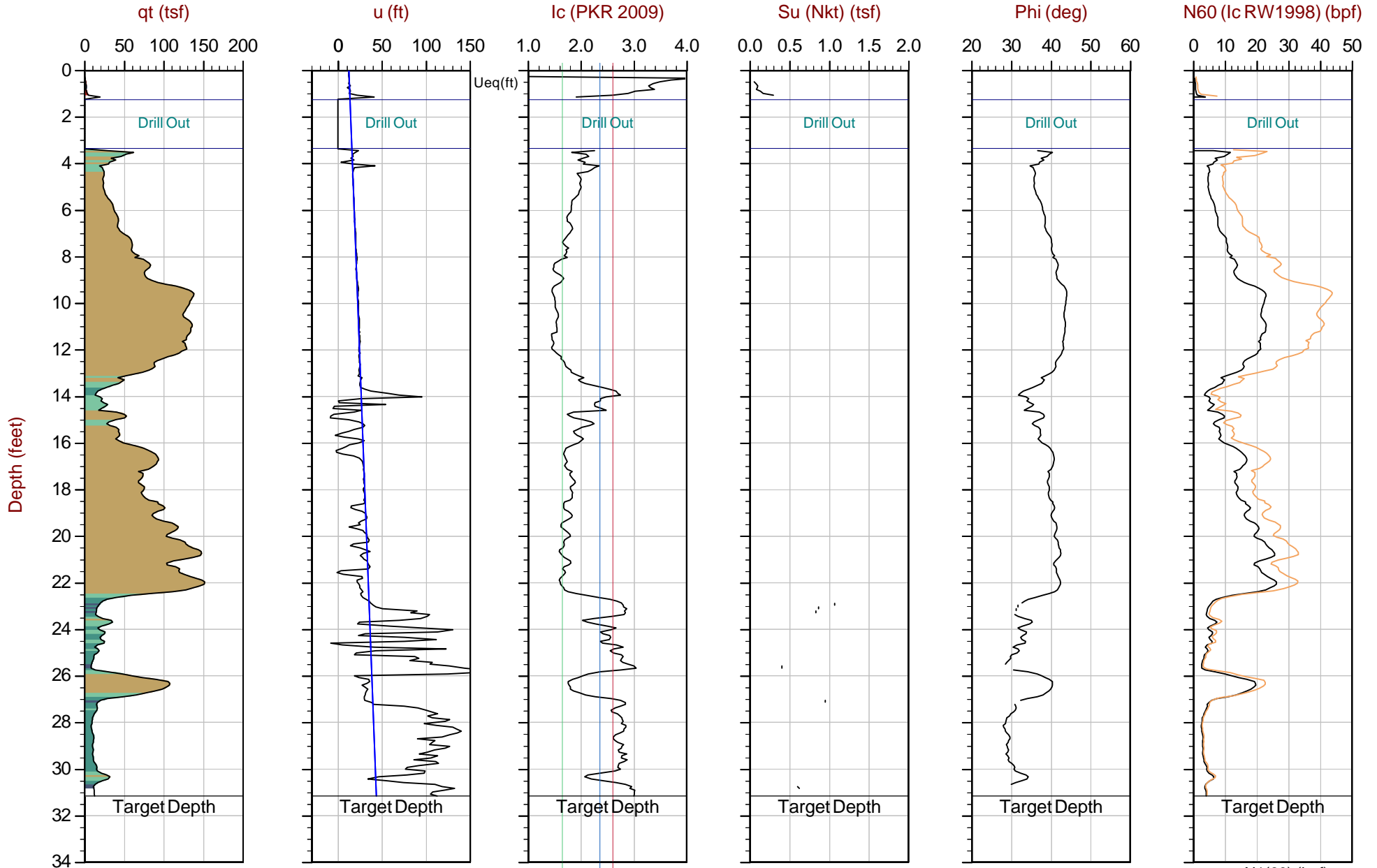
Max Depth: 2.975 m / 9.76 ft  
 Depth Inc: 0.025 m / 0.082 ft  
 Avg Int: Every Point

File: 21-59-22445\_CP46.COR  
 Unit Wt: SBTQtn(PKR2009)  
 Su Nkt: 15.0

SBT: Robertson, 2009 and 2010  
 Coords: Lat: 47.51233 Long: -122.29862

● Equilibrium Pore Pressure (Ueq)    
 ● Assumed Ueq    
 ◀ Dissipation, Ueq achieved    
 ◀ Dissipation, Ueq not achieved    
 — Hydrostatic Line

The reported coordinates were acquired from hand-held GPS equipment and are only approximate locations. The coordinates should not be used for design purposes.



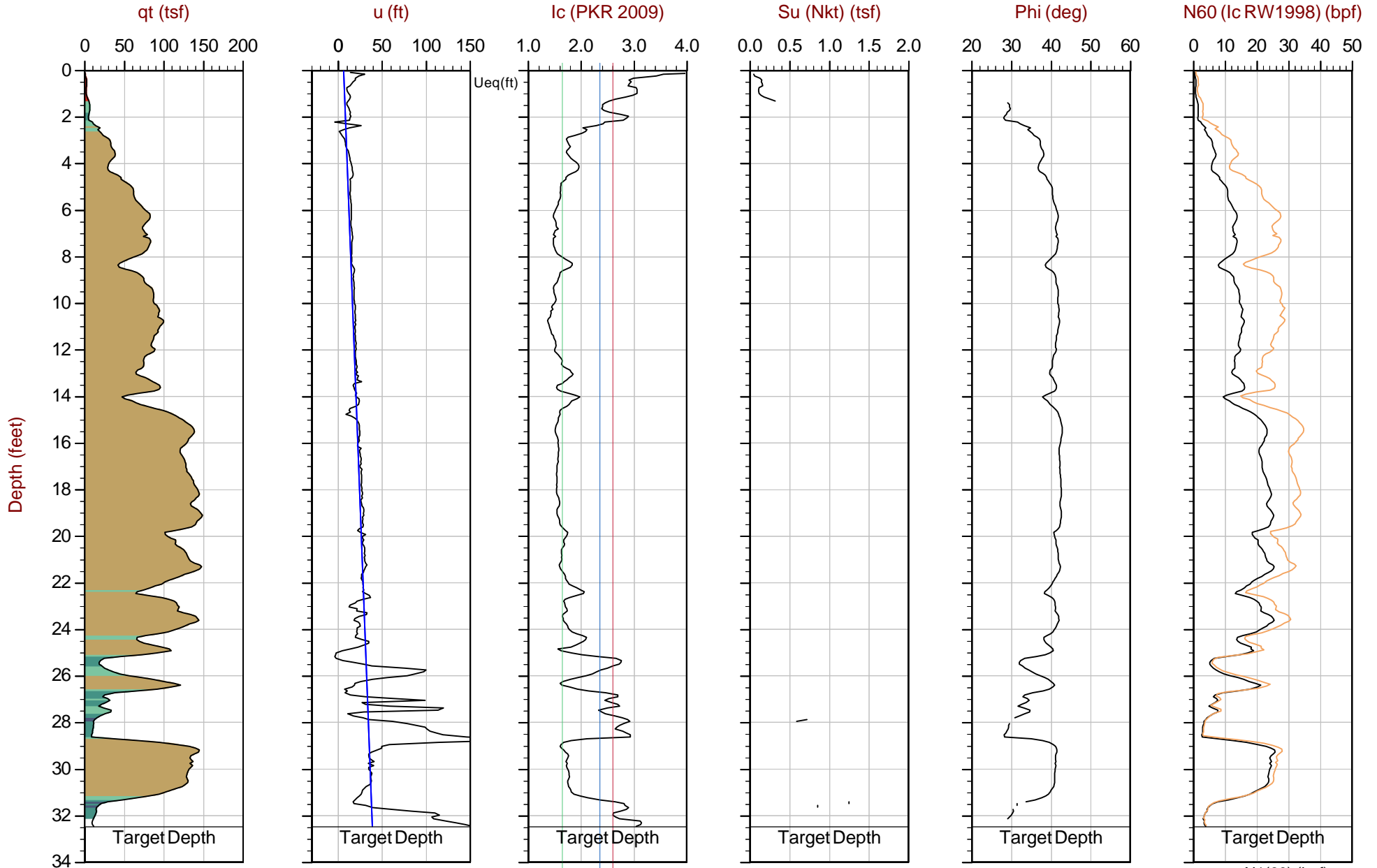
Max Depth: 9.500 m / 31.17 ft  
 Depth Inc: 0.025 m / 0.082 ft  
 Avg Int: Every Point

File: 21-59-22445\_CP47.COR  
 Unit Wt: SBTQtn(PKR2009)  
 Su Nkt: 15.0

SBT: Robertson, 2009 and 2010  
 Coords: Lat: 47.51242 Long: -122.29865

● Equilibrium Pore Pressure (Ueq)    
 ● Assumed Ueq    
 ◀ Dissipation, Ueq achieved    
 ◀ Dissipation, Ueq not achieved    
 — Hydrostatic Line

The reported coordinates were acquired from hand-held GPS equipment and are only approximate locations. The coordinates should not be used for design purposes.



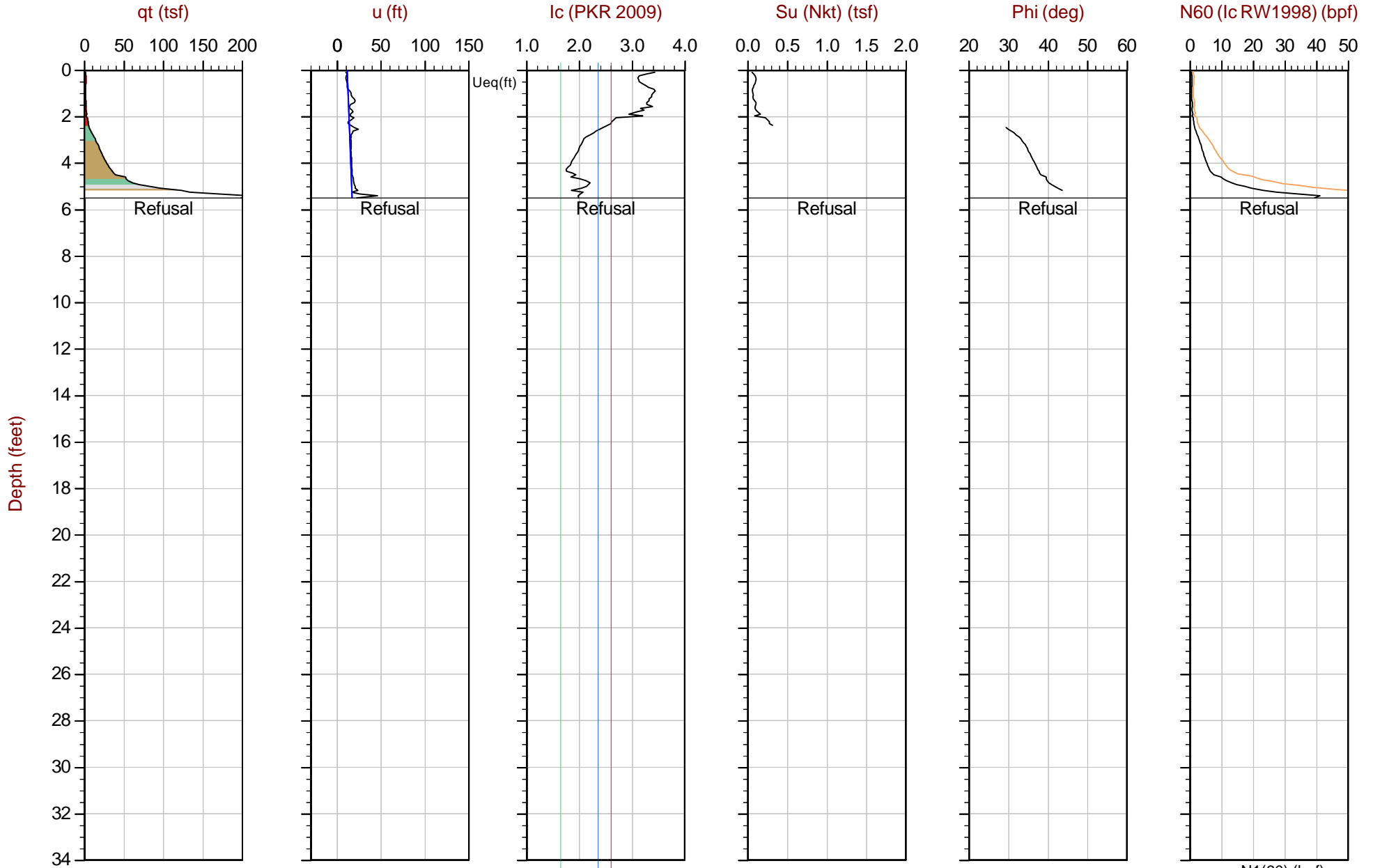
Max Depth: 9.900 m / 32.48 ft  
 Depth Inc: 0.025 m / 0.082 ft  
 Avg Int: Every Point

File: 21-59-22445\_CP49.COR  
 Unit Wt: SBTQtn(PKR2009)  
 Su Nkt: 15.0

SBT: Robertson, 2009 and 2010  
 Coords: Lat: 47.51235 Long: -122.29820

● Equilibrium Pore Pressure (Ueq)    
 ● Assumed Ueq    
 ◀ Dissipation, Ueq achieved    
 ◀ Dissipation, Ueq not achieved    
 — Hydrostatic Line

The reported coordinates were acquired from hand-held GPS equipment and are only approximate locations. The coordinates should not be used for design purposes.



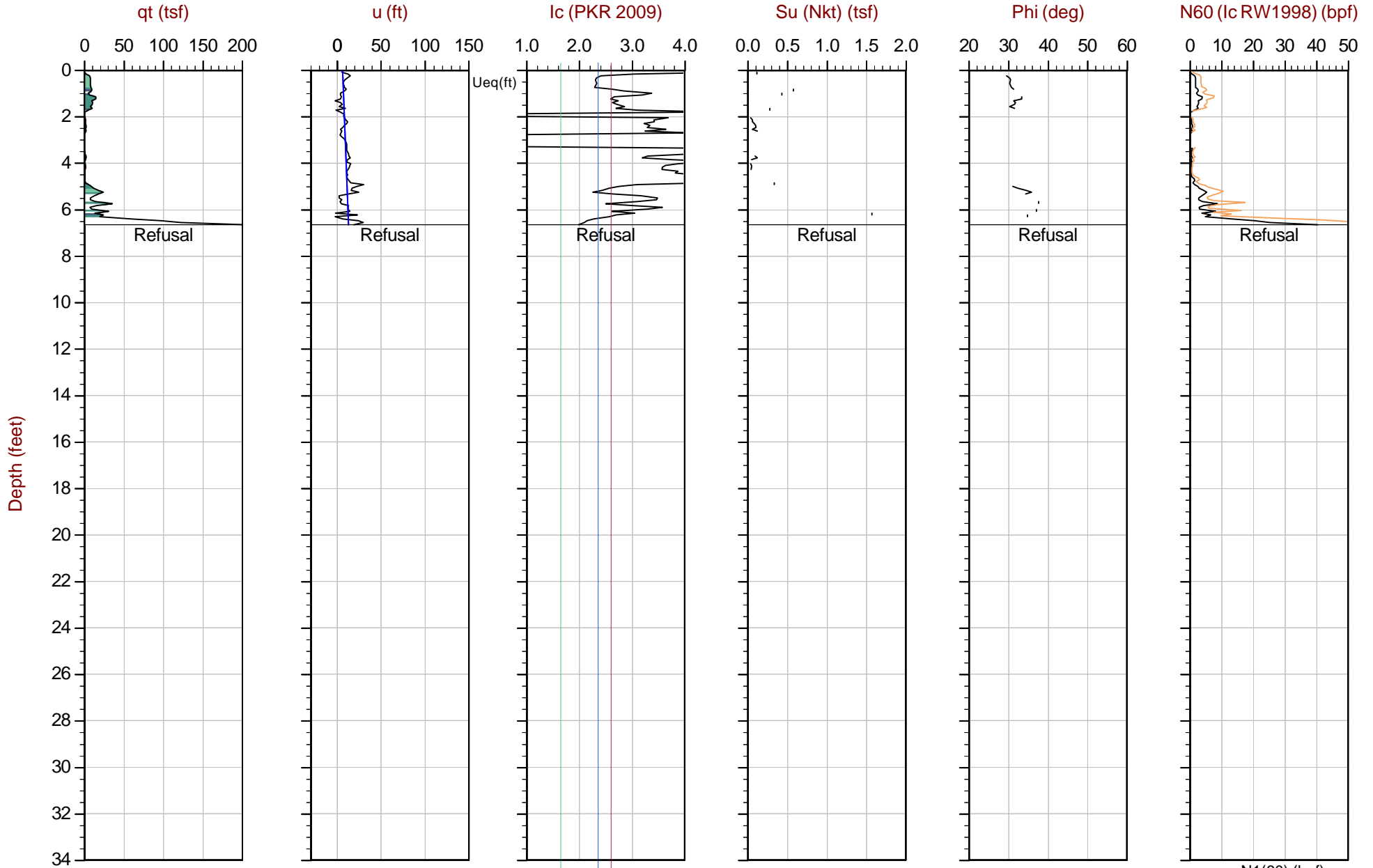
Max Depth: 1.675 m / 5.50 ft  
 Depth Inc: 0.025 m / 0.082 ft  
 Avg Int: Every Point

File: 21-59-22445\_CP50.COR  
 Unit Wt: SBTQtn (PKR2009)  
 Su Nkt: 15.0

SBT: Robertson, 2009 and 2010  
 Coords: Lat: 47.51207 Long: -122.29793

● Equilibrium Pore Pressure (Ueq)    
 ● Assumed Ueq    
 ◀ Dissipation, Ueq achieved    
 ◀ Dissipation, Ueq not achieved    
 — Hydrostatic Line

The reported coordinates were acquired from hand-held GPS equipment and are only approximate locations. The coordinates should not be used for design purposes.



Max Depth: 2.025 m / 6.64 ft  
 Depth Inc: 0.025 m / 0.082 ft  
 Avg Int: Every Point

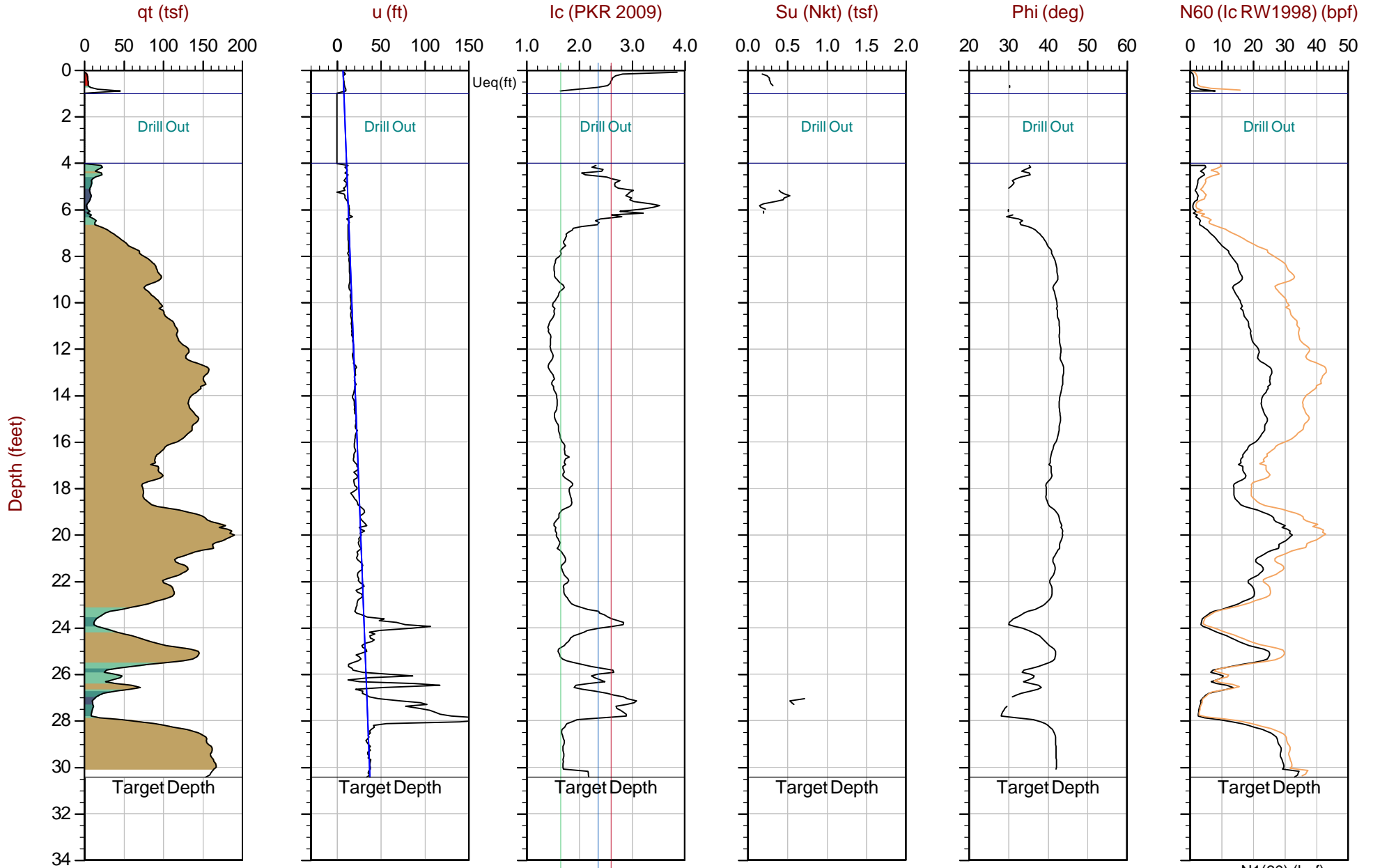
File: 21-59-22445\_CP51.COR  
 Unit Wt: SBTQtn(PKR2009)  
 Su Nkt: 15.0

SBT: Robertson, 2009 and 2010  
 Coords: Lat: 47.51218 Long: -122.29794

● Equilibrium Pore Pressure (Ueq)    
 ● Assumed Ueq    
 ◀ Dissipation, Ueq achieved    
 ◀ Dissipation, Ueq not achieved    
 — Hydrostatic Line

The reported coordinates were acquired from hand-held GPS equipment and are only approximate locations. The coordinates should not be used for design purposes.





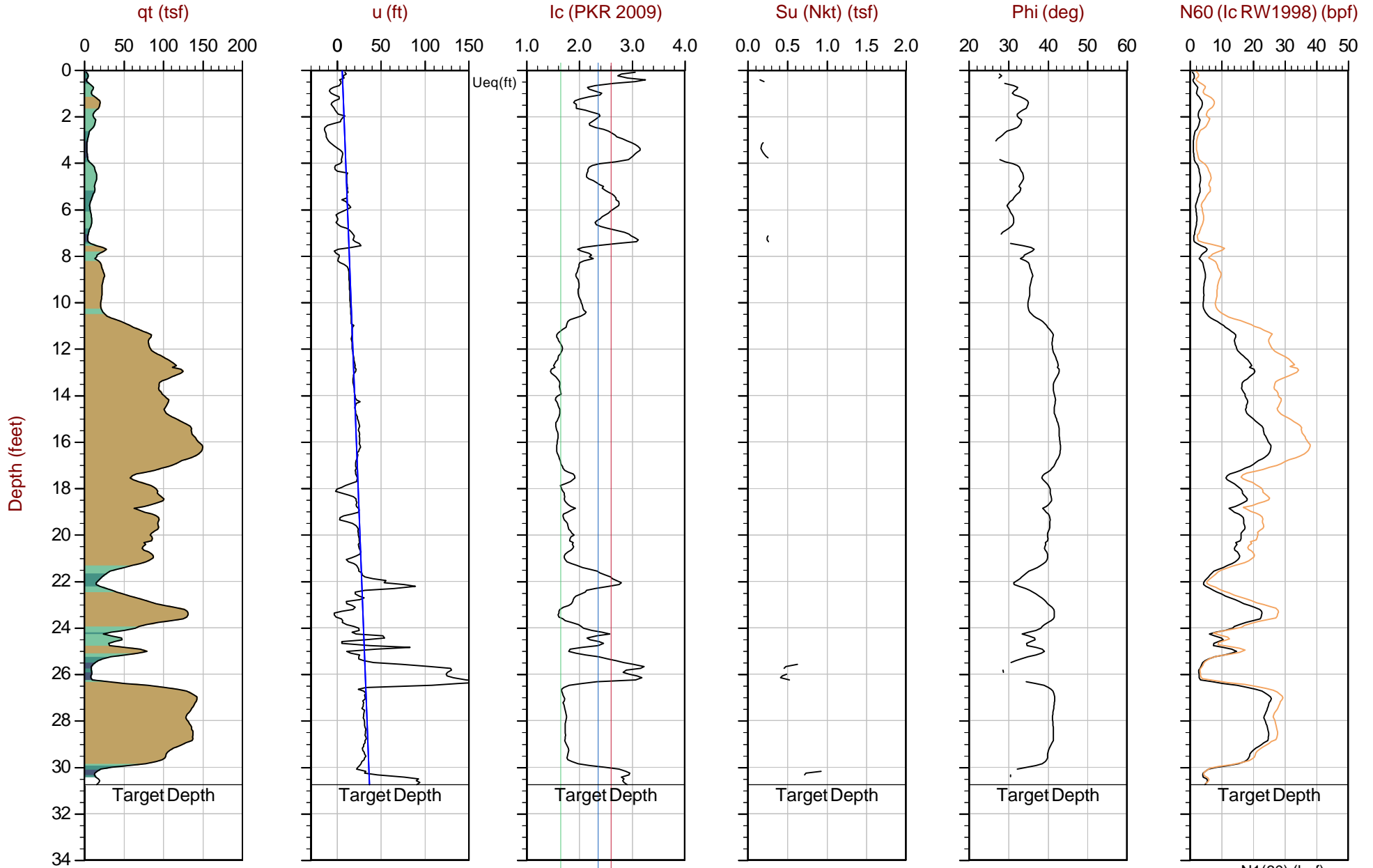
Max Depth: 9.275 m / 30.43 ft  
 Depth Inc: 0.025 m / 0.082 ft  
 Avg Int: Every Point

File: 21-59-22445\_CP52.COR  
 Unit Wt: SBTQtn(PKR2009)  
 Su Nkt: 15.0

SBT: Robertson, 2009 and 2010  
 Coords: Lat: 47.51211 Long: -122.29774

● Equilibrium Pore Pressure (Ueq)    
 ● Assumed Ueq    
 ◀ Dissipation, Ueq achieved    
 ◀ Dissipation, Ueq not achieved    
 — Hydrostatic Line

The reported coordinates were acquired from hand-held GPS equipment and are only approximate locations. The coordinates should not be used for design purposes.



Max Depth: 9.375 m / 30.76 ft  
 Depth Inc: 0.025 m / 0.082 ft  
 Avg Int: Every Point

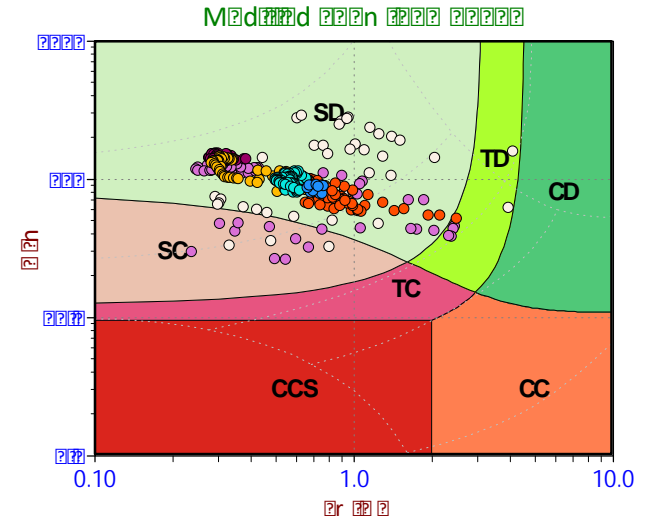
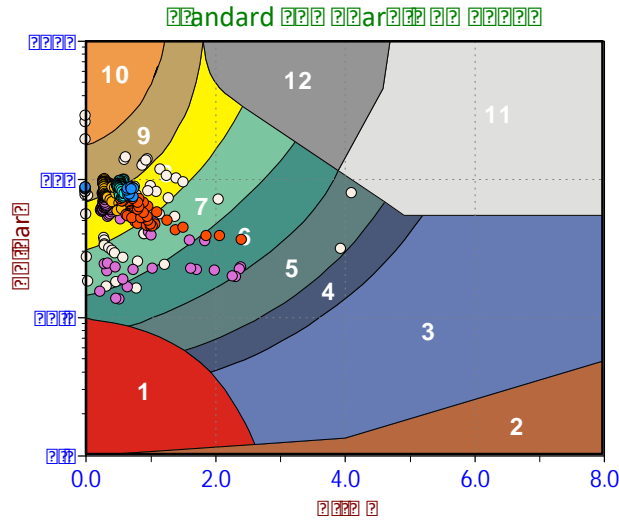
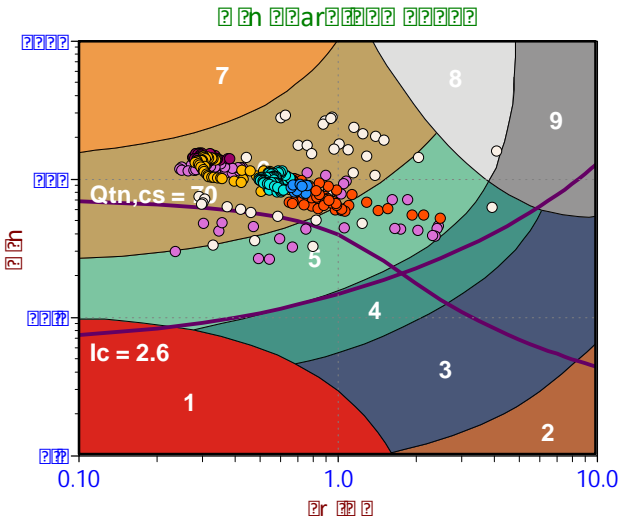
File: 21-59-22445\_CP54.COR  
 Unit Wt: SBTQtn(PKR2009)  
 Su Nkt: 15.0

SBT: Robertson, 2009 and 2010  
 Coords: Lat: 47.51197 Long: -122.29758

● Equilibrium Pore Pressure (Ueq)    
 ● Assumed Ueq    
 ◀ Dissipation, Ueq achieved    
 ◀ Dissipation, Ueq not achieved    
 — Hydrostatic Line

The reported coordinates were acquired from hand-held GPS equipment and are only approximate locations. The coordinates should not be used for design purposes.

## Soil Behavior Type (SBT) Scatter Plots



**Depth Ranges**

- >0.0 to 5.0 ft
- >5.0 to 10.0 ft
- >10.0 to 15.0 ft
- >15.0 to 20.0 ft
- >20.0 to 25.0 ft
- >25.0 to 30.0 ft
- >30.0 to 35.0 ft
- >35.0 to 40.0 ft
- >40.0 to 45.0 ft
- >45.0 to 50.0 ft
- >50.0 ft

**Legend**

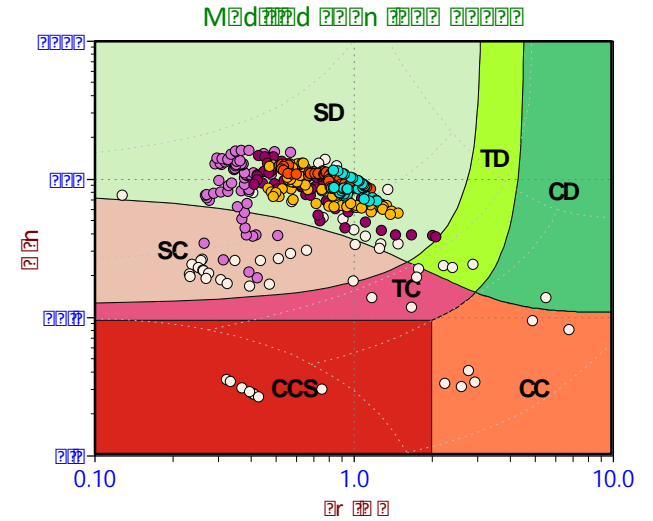
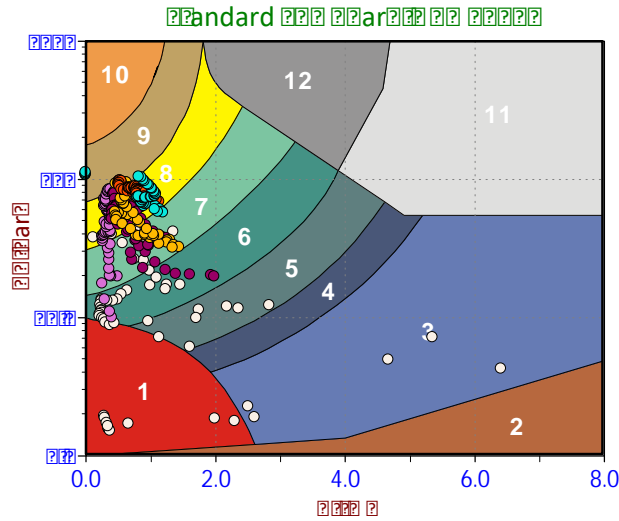
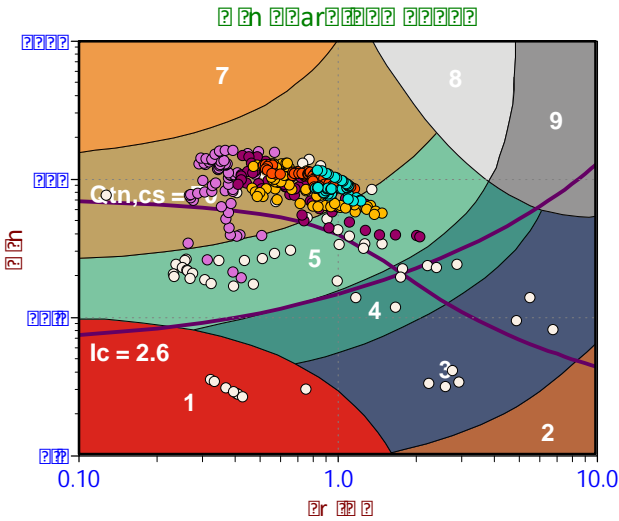
- Sensitive, Fine Grained
- Organic Soils
- Clays
- Silt Mixtures
- Sand Mixtures
- Sands
- Gravelly Sand to Sand
- Stiff Sand to Clayey Sand
- Very Stiff Fine Grained

**Legend**

- Sensitive Fines
- Organic Soil
- Clay
- Silty Clay
- Clayey Silt
- Silt
- Sandy Silt
- Silty Sand/Sand
- Sand
- Gravelly Sand
- Stiff Fine Grained
- Cemented Sand

**Legend**

- CCS (Cont. sensitive clay like)
- CC (Cont. clay like)
- TC (Cont. transitional)
- SC (Cont. sand like)
- CD (Dil. clay like)
- TD (Dil. transitional)
- SD (Dil. sand like)



**Depth Ranges**

- >0.0 to 5.0 ft
- >5.0 to 10.0 ft
- >10.0 to 15.0 ft
- >15.0 to 20.0 ft
- >20.0 to 25.0 ft
- >25.0 to 30.0 ft
- >30.0 to 35.0 ft
- >35.0 to 40.0 ft
- >40.0 to 45.0 ft
- >45.0 to 50.0 ft
- >50.0 ft

**Legend**

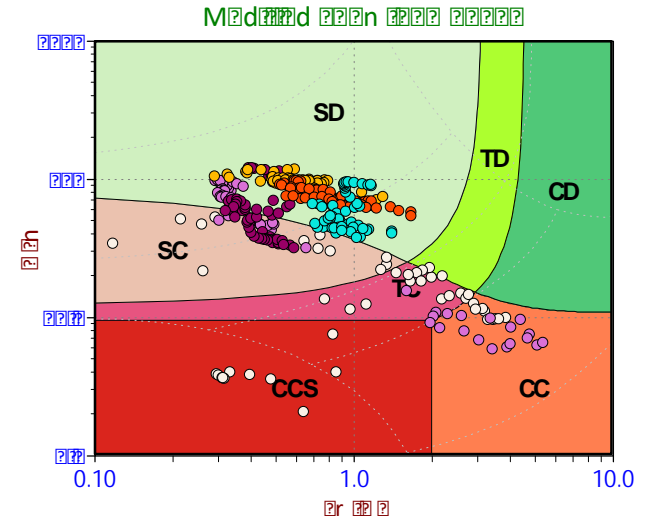
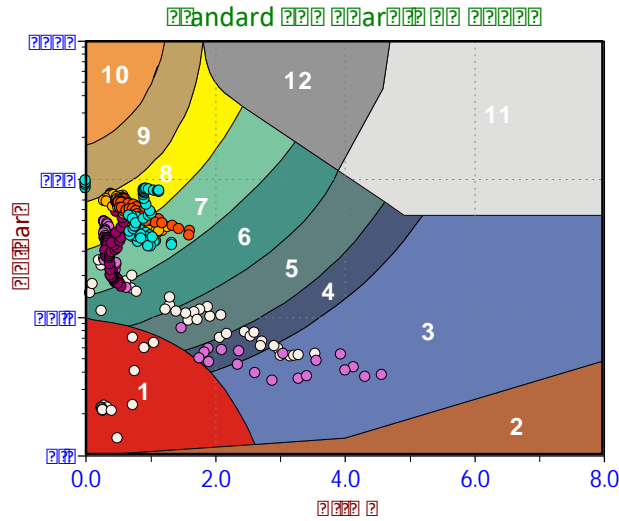
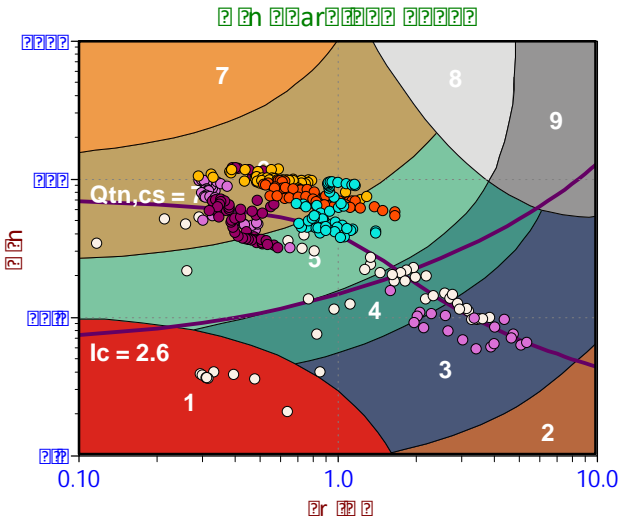
- Sensitive, Fine Grained
- Organic Soils
- Clays
- Silt Mixtures
- Sand Mixtures
- Sands
- Gravelly Sand to Sand
- Stiff Sand to Clayey Sand
- Very Stiff Fine Grained

**Legend**

- Sensitive Fines
- Organic Soil
- Clay
- Silty Clay
- Clayey Silt
- Silt
- Sandy Silt
- Silty Sand/Sand
- Sand
- Gravelly Sand
- Stiff Fine Grained
- Cemented Sand

**Legend**

- CCS (Cont. sensitive clay like)
- CC (Cont. clay like)
- TC (Cont. transitional)
- SC (Cont. sand like)
- CD (Dil. clay like)
- TD (Dil. transitional)
- SD (Dil. sand like)



**Depth Ranges**

- >0.0 to 5.0 ft
- >5.0 to 10.0 ft
- >10.0 to 15.0 ft
- >15.0 to 20.0 ft
- >20.0 to 25.0 ft
- >25.0 to 30.0 ft
- >30.0 to 35.0 ft
- >35.0 to 40.0 ft
- >40.0 to 45.0 ft
- >45.0 to 50.0 ft
- >50.0 ft

**Legend**

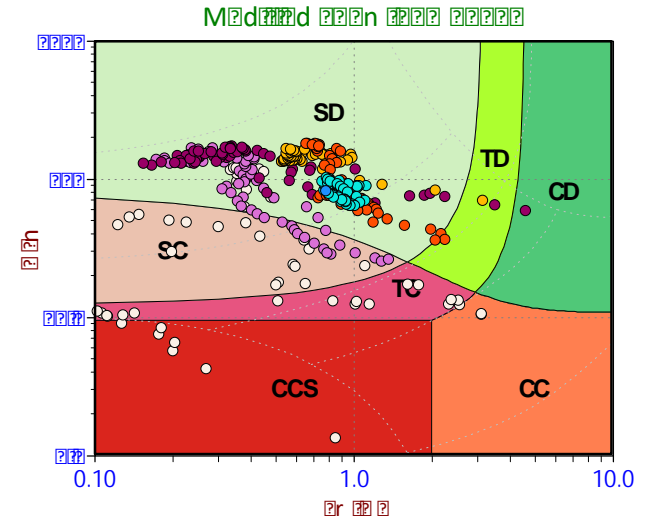
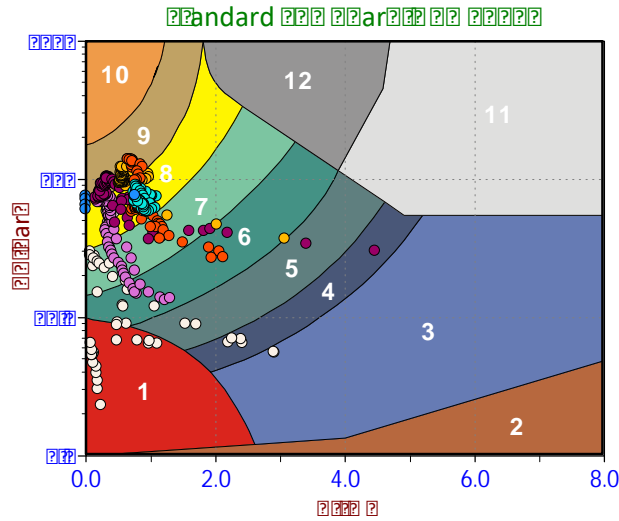
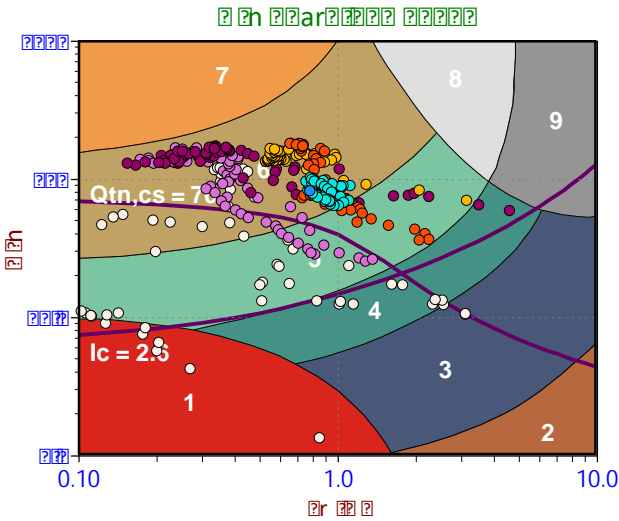
- Sensitive, Fine Grained
- Organic Soils
- Clays
- Silt Mixtures
- Sand Mixtures
- Sands
- Gravelly Sand to Sand
- Stiff Sand to Clayey Sand
- Very Stiff Fine Grained

**Legend**

- Sensitive Fines
- Organic Soil
- Clay
- Silty Clay
- Clayey Silt
- Silt
- Sandy Silt
- Silty Sand/Sand
- Sand
- Gravelly Sand
- Stiff Fine Grained
- Cemented Sand

**Legend**

- CCS (Cont. sensitive clay like)
- CC (Cont. clay like)
- TC (Cont. transitional)
- SC (Cont. sand like)
- CD (Dil. clay like)
- TD (Dil. transitional)
- SD (Dil. sand like)



**Depth Ranges**

- >0.0 to 5.0 ft
- >5.0 to 10.0 ft
- >10.0 to 15.0 ft
- >15.0 to 20.0 ft
- >20.0 to 25.0 ft
- >25.0 to 30.0 ft
- >30.0 to 35.0 ft
- >35.0 to 40.0 ft
- >40.0 to 45.0 ft
- >45.0 to 50.0 ft
- >50.0 ft

**Legend**

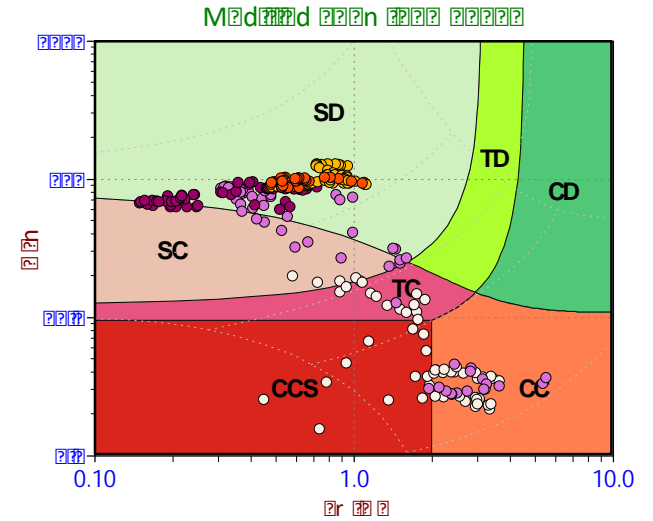
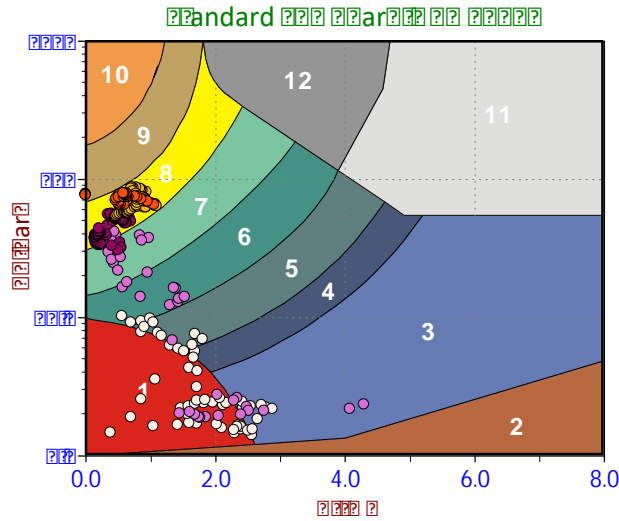
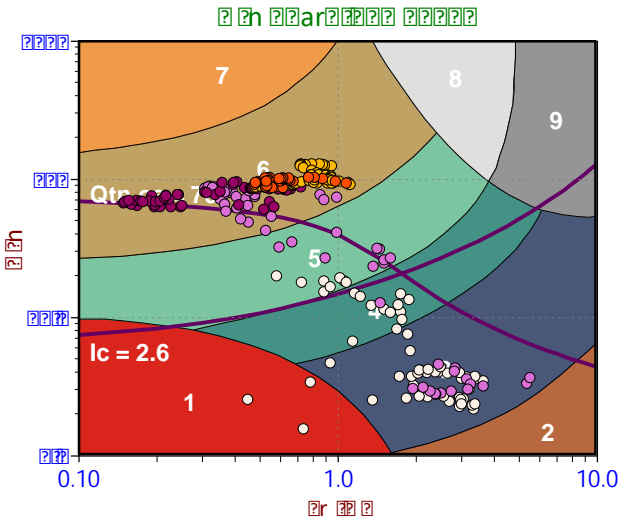
- Sensitive, Fine Grained
- Organic Soils
- Clays
- Silt Mixtures
- Sand Mixtures
- Sands
- Gravelly Sand to Sand
- Stiff Sand to Clayey Sand
- Very Stiff Fine Grained

**Legend**

- Sensitive Fines
- Organic Soil
- Clay
- Silty Clay
- Clayey Silt
- Silt
- Sandy Silt
- Silty Sand/Sand
- Sand
- Gravelly Sand
- Stiff Fine Grained
- Cemented Sand

**Legend**

- CCS (Cont. sensitive clay like)
- CC (Cont. clay like)
- TC (Cont. transitional)
- SC (Cont. sand like)
- CD (Dil. clay like)
- TD (Dil. transitional)
- SD (Dil. sand like)



### Depth Ranges

- >0.0 to 5.0 ft
- >5.0 to 10.0 ft
- >10.0 to 15.0 ft
- >15.0 to 20.0 ft
- >20.0 to 25.0 ft
- >25.0 to 30.0 ft
- >30.0 to 35.0 ft
- >35.0 to 40.0 ft
- >40.0 to 45.0 ft
- >45.0 to 50.0 ft
- >50.0 ft

### Legend

- Sensitive, Fine Grained
- Organic Soils
- Clays
- Silt Mixtures
- Sand Mixtures
- Sands
- Gravelly Sand to Sand
- Stiff Sand to Clayey Sand
- Very Stiff Fine Grained

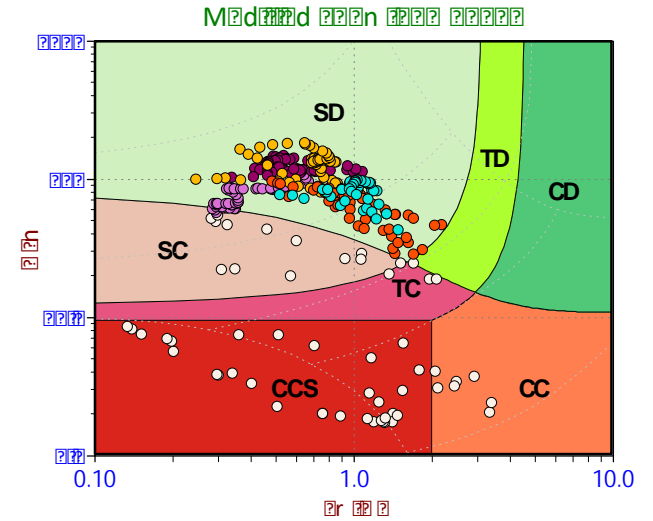
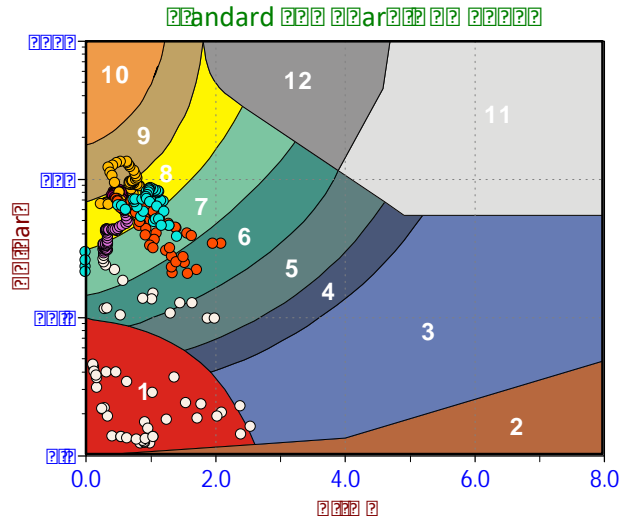
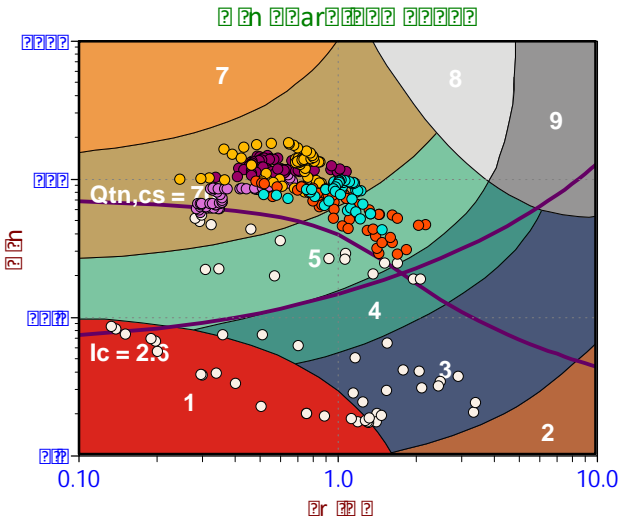
### Legend

- Sensitive Fines
- Organic Soil
- Clay
- Silty Clay
- Clayey Silt
- Silt
- Sandy Silt
- Silty Sand/Sand
- Sand
- Gravelly Sand
- Stiff Fine Grained
- Cemented Sand

### Legend

- CCS (Cont. sensitive clay like)
- CC (Cont. clay like)
- TC (Cont. transitional)
- SC (Cont. sand like)
- CD (Dil. clay like)
- TD (Dil. transitional)
- SD (Dil. sand like)





**Depth Ranges**

- >0.0 to 5.0 ft
- >5.0 to 10.0 ft
- >10.0 to 15.0 ft
- >15.0 to 20.0 ft
- >20.0 to 25.0 ft
- >25.0 to 30.0 ft
- >30.0 to 35.0 ft
- >35.0 to 40.0 ft
- >40.0 to 45.0 ft
- >45.0 to 50.0 ft
- >50.0 ft

**Legend**

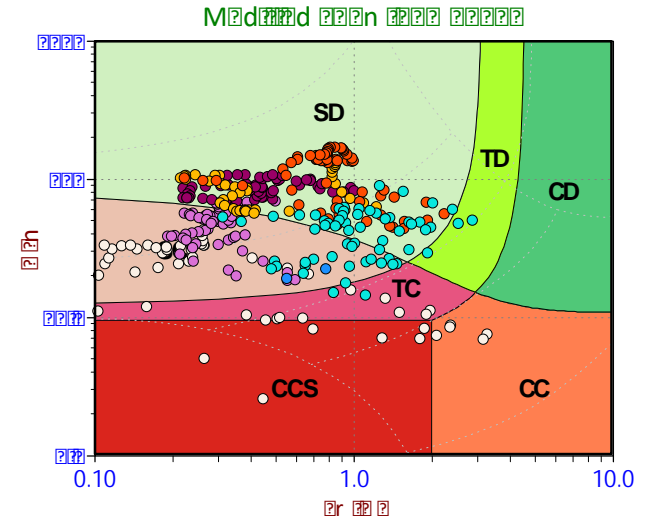
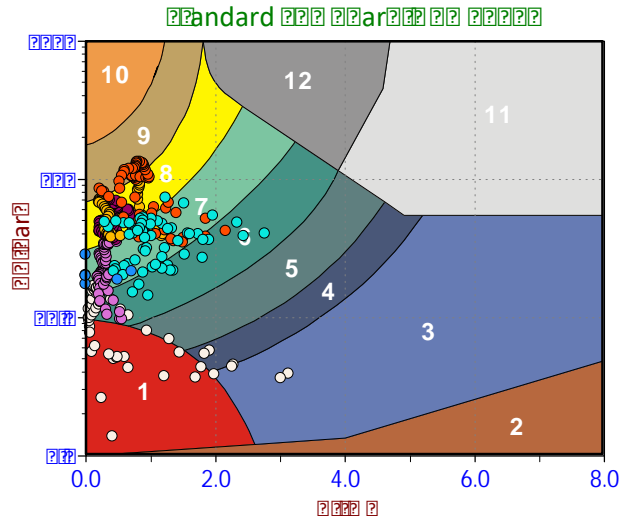
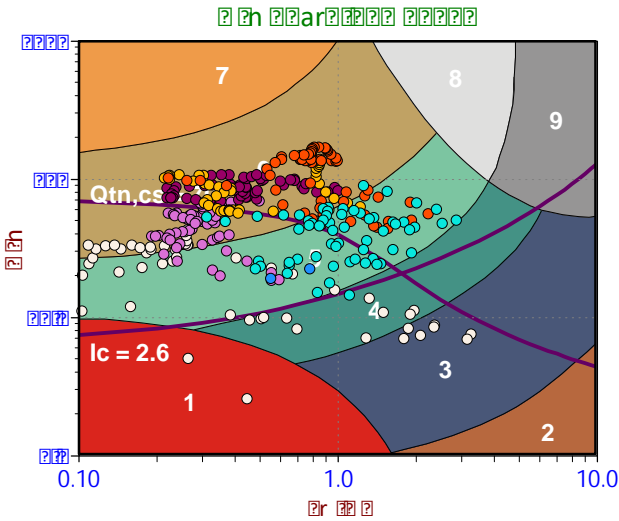
- Sensitive, Fine Grained
- Organic Soils
- Clays
- Silt Mixtures
- Sand Mixtures
- Sands
- Gravelly Sand to Sand
- Stiff Sand to Clayey Sand
- Very Stiff Fine Grained

**Legend**

- Sensitive Fines
- Organic Soil
- Clay
- Silty Clay
- Clayey Silt
- Silt
- Sandy Silt
- Silty Sand/Sand
- Sand
- Gravelly Sand
- Stiff Fine Grained
- Cemented Sand

**Legend**

- CCS (Cont. sensitive clay like)
- CC (Cont. clay like)
- TC (Cont. transitional)
- SC (Cont. sand like)
- CD (Dil. clay like)
- TD (Dil. transitional)
- SD (Dil. sand like)



**Depth Ranges**

- >0.0 to 5.0 ft
- >5.0 to 10.0 ft
- >10.0 to 15.0 ft
- >15.0 to 20.0 ft
- >20.0 to 25.0 ft
- >25.0 to 30.0 ft
- >30.0 to 35.0 ft
- >35.0 to 40.0 ft
- >40.0 to 45.0 ft
- >45.0 to 50.0 ft
- >50.0 ft

**Legend**

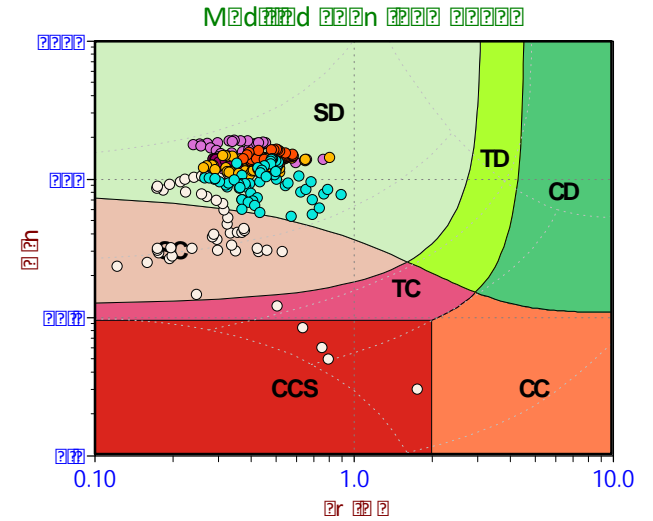
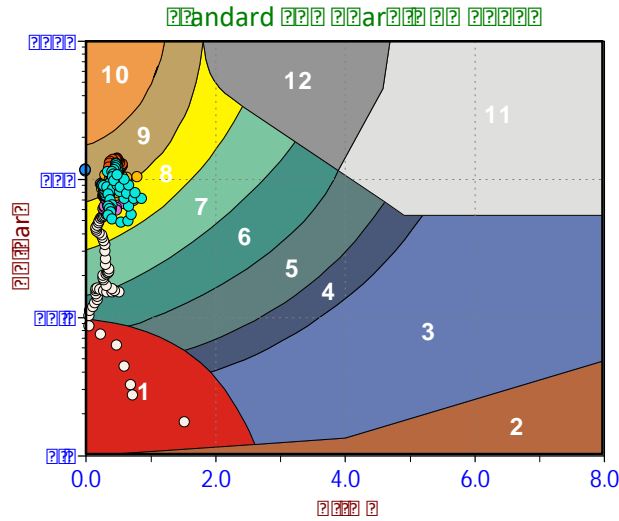
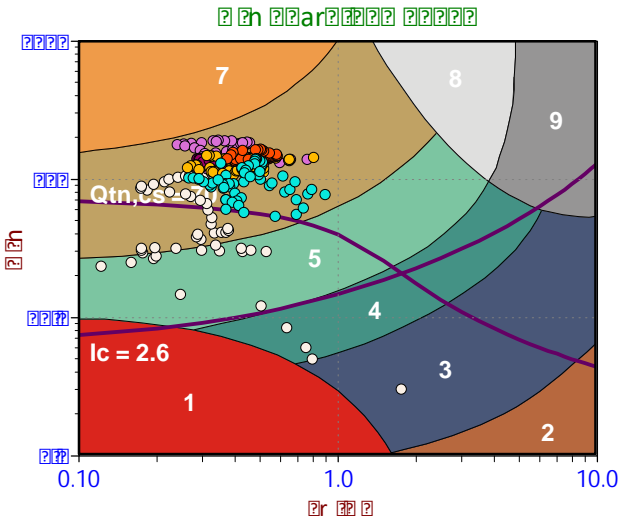
- Sensitive, Fine Grained
- Organic Soils
- Clays
- Silt Mixtures
- Sand Mixtures
- Sands
- Gravelly Sand to Sand
- Stiff Sand to Clayey Sand
- Very Stiff Fine Grained

**Legend**

- Sensitive Fines
- Organic Soil
- Clay
- Silty Clay
- Clayey Silt
- Silt
- Sandy Silt
- Silty Sand/Sand
- Sand
- Gravelly Sand
- Stiff Fine Grained
- Cemented Sand

**Legend**

- CCS (Cont. sensitive clay like)
- CC (Cont. clay like)
- TC (Cont. transitional)
- SC (Cont. sand like)
- CD (Dil. clay like)
- TD (Dil. transitional)
- SD (Dil. sand like)



**Depth Ranges**

- >0.0 to 5.0 ft
- >5.0 to 10.0 ft
- >10.0 to 15.0 ft
- >15.0 to 20.0 ft
- >20.0 to 25.0 ft
- >25.0 to 30.0 ft
- >30.0 to 35.0 ft
- >35.0 to 40.0 ft
- >40.0 to 45.0 ft
- >45.0 to 50.0 ft
- >50.0 ft

**Legend**

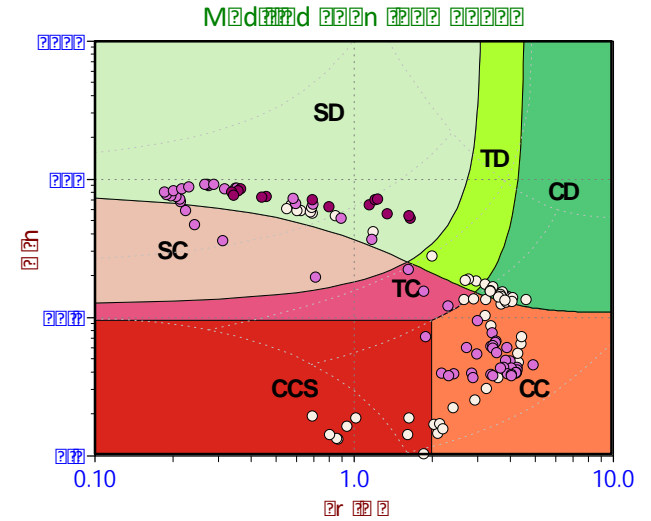
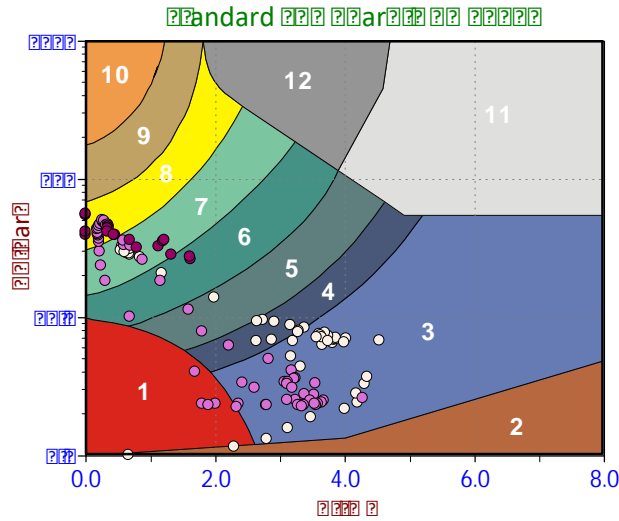
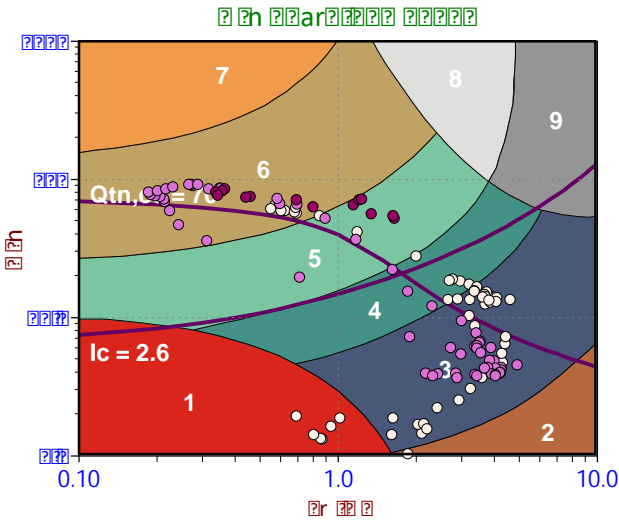
- Sensitive, Fine Grained
- Organic Soils
- Clays
- Silt Mixtures
- Sand Mixtures
- Sands
- Gravelly Sand to Sand
- Stiff Sand to Clayey Sand
- Very Stiff Fine Grained

**Legend**

- Sensitive Fines
- Organic Soil
- Clay
- Silty Clay
- Clayey Silt
- Silt
- Sandy Silt
- Silty Sand/Sand
- Sand
- Gravelly Sand
- Stiff Fine Grained
- Cemented Sand

**Legend**

- CCS (Cont. sensitive clay like)
- CC (Cont. clay like)
- TC (Cont. transitional)
- SC (Cont. sand like)
- CD (Dil. clay like)
- TD (Dil. transitional)
- SD (Dil. sand like)



**Depth Ranges**

- >0.0 to 5.0 ft
- >5.0 to 10.0 ft
- >10.0 to 15.0 ft
- >15.0 to 20.0 ft
- >20.0 to 25.0 ft
- >25.0 to 30.0 ft
- >30.0 to 35.0 ft
- >35.0 to 40.0 ft
- >40.0 to 45.0 ft
- >45.0 to 50.0 ft
- >50.0 ft

**Legend**

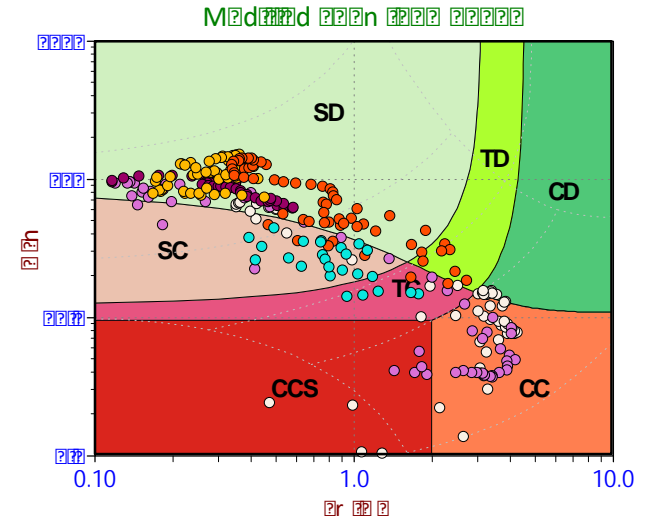
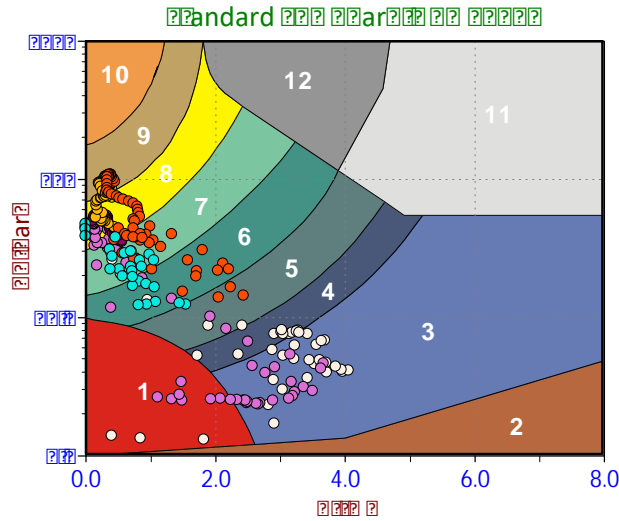
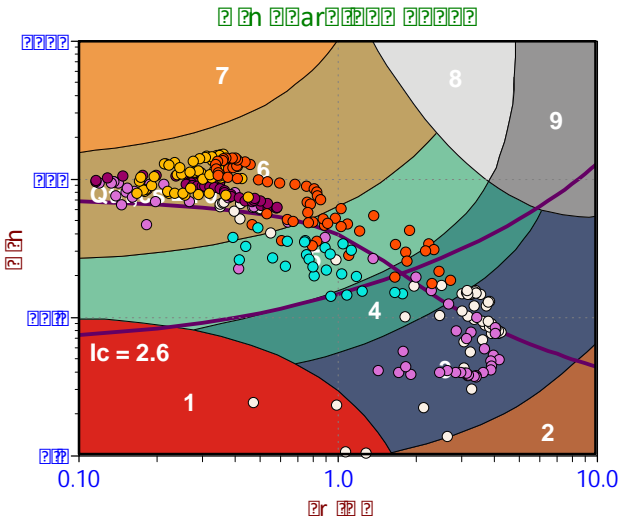
- Sensitive, Fine Grained
- Organic Soils
- Clays
- Silt Mixtures
- Sand Mixtures
- Sands
- Gravelly Sand to Sand
- Stiff Sand to Clayey Sand
- Very Stiff Fine Grained

**Legend**

- Sensitive Fines
- Organic Soil
- Clay
- Silty Clay
- Clayey Silt
- Silt
- Sandy Silt
- Silty Sand/Sand
- Sand
- Gravelly Sand
- Stiff Fine Grained
- Cemented Sand

**Legend**

- CCS (Cont. sensitive clay like)
- CC (Cont. clay like)
- TC (Cont. transitional)
- SC (Cont. sand like)
- CD (Dil. clay like)
- TD (Dil. transitional)
- SD (Dil. sand like)



**Depth Ranges**

- >0.0 to 5.0 ft
- >5.0 to 10.0 ft
- >10.0 to 15.0 ft
- >15.0 to 20.0 ft
- >20.0 to 25.0 ft
- >25.0 to 30.0 ft
- >30.0 to 35.0 ft
- >35.0 to 40.0 ft
- >40.0 to 45.0 ft
- >45.0 to 50.0 ft
- >50.0 ft

**Legend**

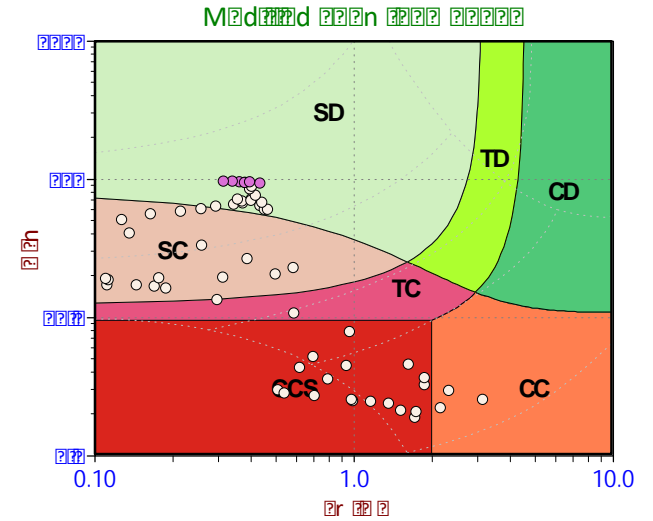
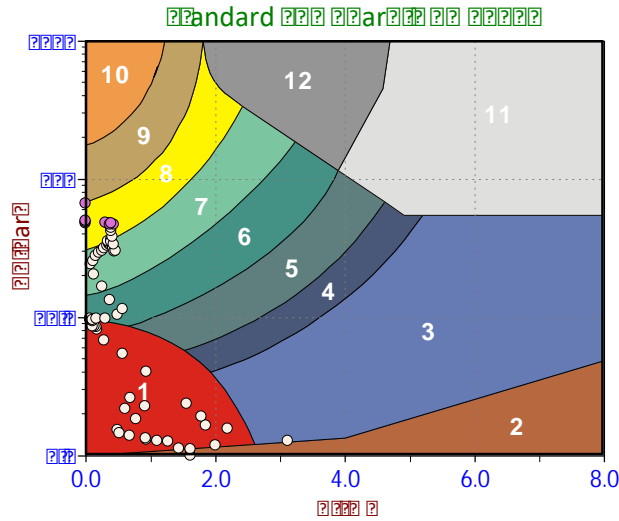
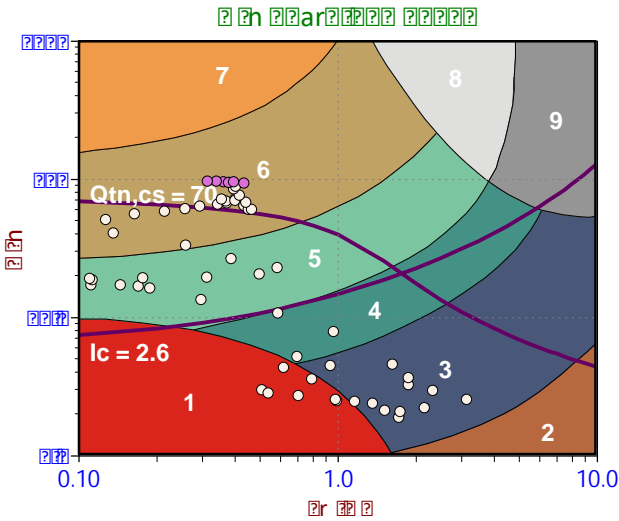
- Sensitive, Fine Grained
- Organic Soils
- Clays
- Silt Mixtures
- Sand Mixtures
- Sands
- Gravelly Sand to Sand
- Stiff Sand to Clayey Sand
- Very Stiff Fine Grained

**Legend**

- Sensitive Fines
- Organic Soil
- Clay
- Silty Clay
- Clayey Silt
- Silt
- Sandy Silt
- Silty Sand/Sand
- Sand
- Gravelly Sand
- Stiff Fine Grained
- Cemented Sand

**Legend**

- CCS (Cont. sensitive clay like)
- CC (Cont. clay like)
- TC (Cont. transitional)
- SC (Cont. sand like)
- CD (Dil. clay like)
- TD (Dil. transitional)
- SD (Dil. sand like)



**Depth Ranges**

- >0.0 to 5.0 ft
- >5.0 to 10.0 ft
- >10.0 to 15.0 ft
- >15.0 to 20.0 ft
- >20.0 to 25.0 ft
- >25.0 to 30.0 ft
- >30.0 to 35.0 ft
- >35.0 to 40.0 ft
- >40.0 to 45.0 ft
- >45.0 to 50.0 ft
- >50.0 ft

**Legend**

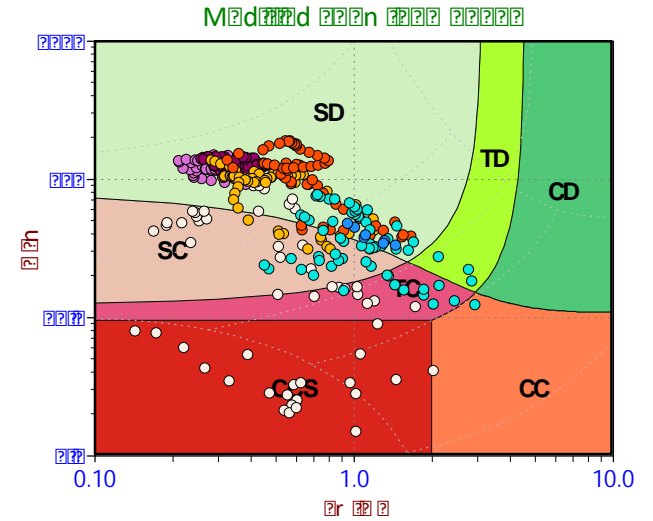
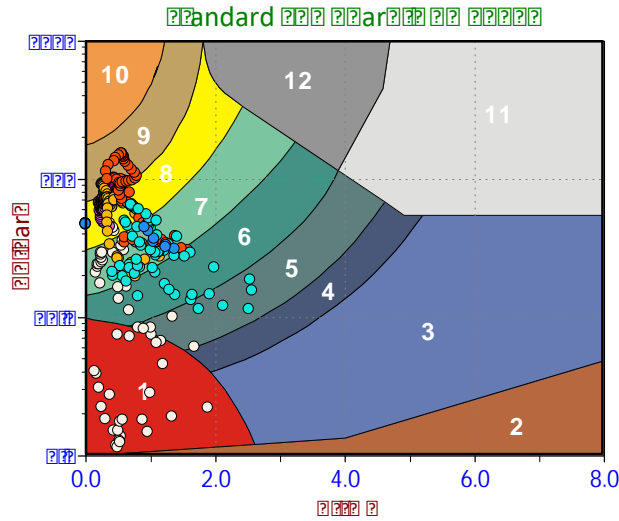
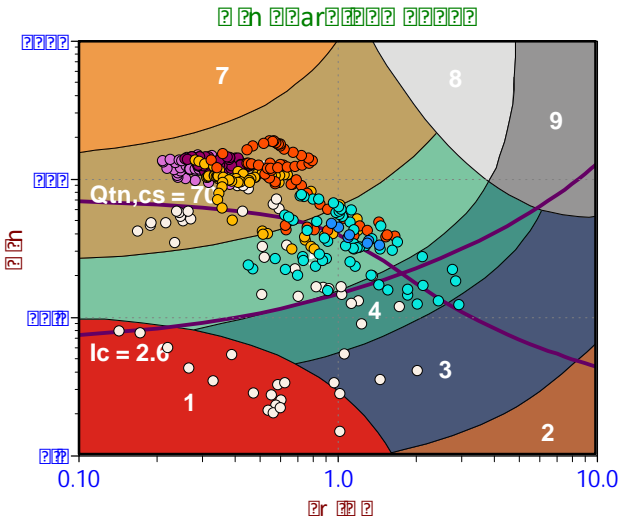
- Sensitive, Fine Grained
- Organic Soils
- Clays
- Silt Mixtures
- Sand Mixtures
- Sands
- Gravelly Sand to Sand
- Stiff Sand to Clayey Sand
- Very Stiff Fine Grained

**Legend**

- Sensitive Fines
- Organic Soil
- Clay
- Silty Clay
- Clayey Silt
- Silt
- Sandy Silt
- Silty Sand/Sand
- Sand
- Gravelly Sand
- Stiff Fine Grained
- Cemented Sand

**Legend**

- CCS (Cont. sensitive clay like)
- CC (Cont. clay like)
- TC (Cont. transitional)
- SC (Cont. sand like)
- CD (Dil. clay like)
- TD (Dil. transitional)
- SD (Dil. sand like)



### Depth Ranges

- >0.0 to 5.0 ft
- >5.0 to 10.0 ft
- >10.0 to 15.0 ft
- >15.0 to 20.0 ft
- >20.0 to 25.0 ft
- >25.0 to 30.0 ft
- >30.0 to 35.0 ft
- >35.0 to 40.0 ft
- >40.0 to 45.0 ft
- >45.0 to 50.0 ft
- >50.0 ft

### Legend

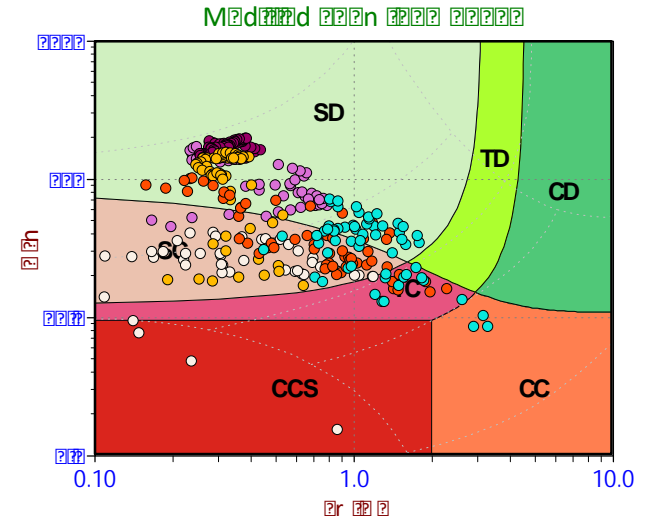
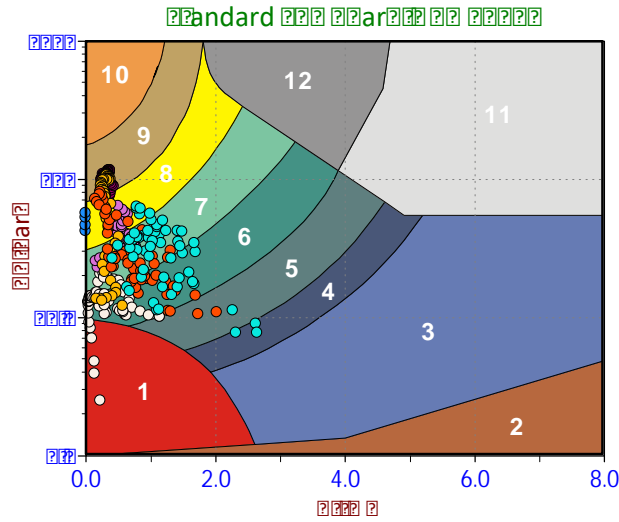
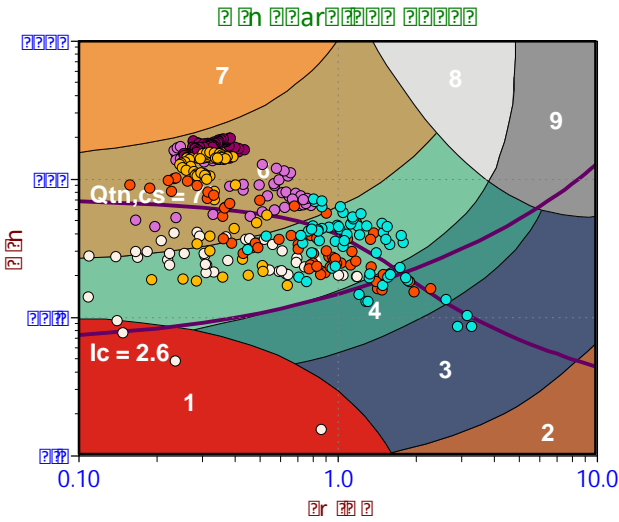
- Sensitive, Fine Grained
- Organic Soils
- Clays
- Silt Mixtures
- Sand Mixtures
- Sands
- Gravelly Sand to Sand
- Stiff Sand to Clayey Sand
- Very Stiff Fine Grained

### Legend

- Sensitive Fines
- Organic Soil
- Clay
- Silty Clay
- Clayey Silt
- Silt
- Sandy Silt
- Silty Sand/Sand
- Sand
- Gravelly Sand
- Stiff Fine Grained
- Cemented Sand

### Legend

- CCS (Cont. sensitive clay like)
- CC (Cont. clay like)
- TC (Cont. transitional)
- SC (Cont. sand like)
- CD (Dil. clay like)
- TD (Dil. transitional)
- SD (Dil. sand like)



**Depth Ranges**

- >0.0 to 5.0 ft
- >5.0 to 10.0 ft
- >10.0 to 15.0 ft
- >15.0 to 20.0 ft
- >20.0 to 25.0 ft
- >25.0 to 30.0 ft
- >30.0 to 35.0 ft
- >35.0 to 40.0 ft
- >40.0 to 45.0 ft
- >45.0 to 50.0 ft
- >50.0 ft

**Legend**

- Sensitive, Fine Grained
- Organic Soils
- Clays
- Silt Mixtures
- Sand Mixtures
- Sands
- Gravelly Sand to Sand
- Stiff Sand to Clayey Sand
- Very Stiff Fine Grained

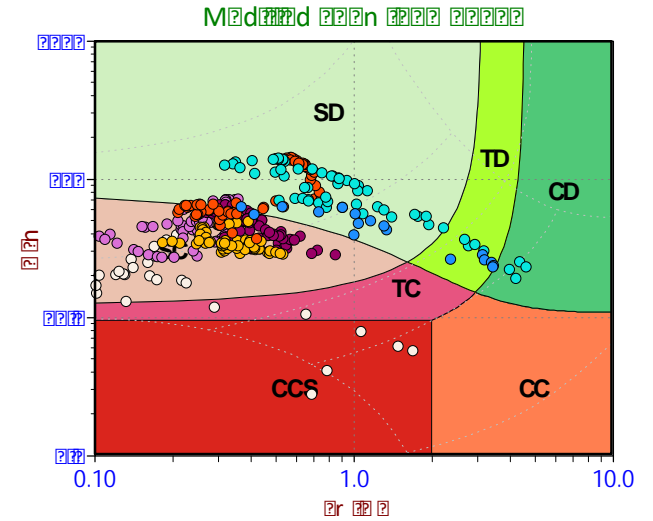
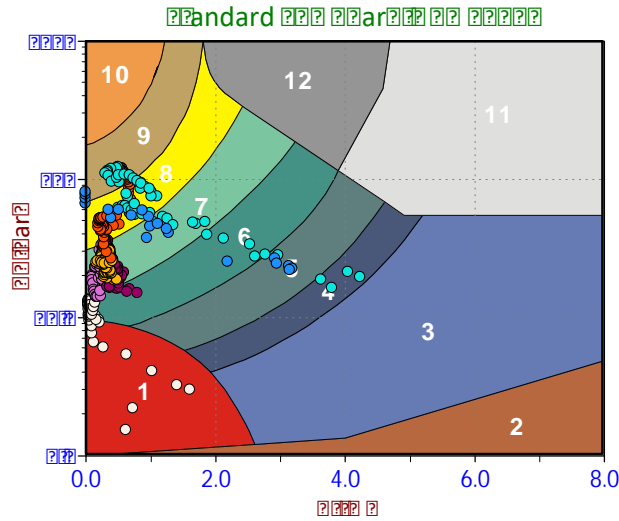
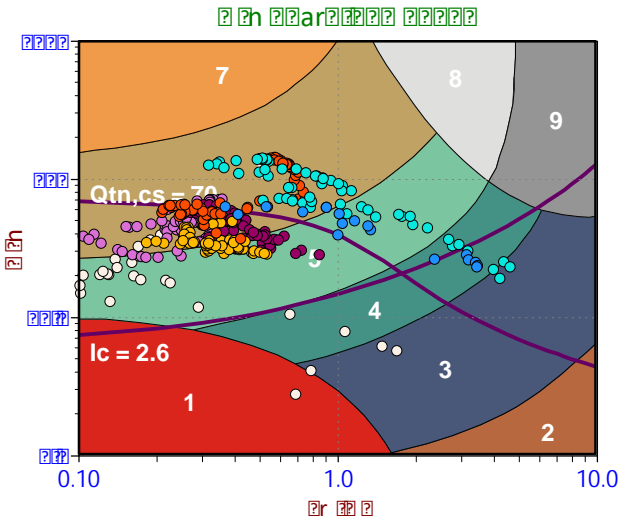
**Legend**

- Sensitive Fines
- Organic Soil
- Clay
- Silty Clay
- Clayey Silt
- Silt
- Sandy Silt
- Silty Sand/Sand
- Sand
- Gravelly Sand
- Stiff Fine Grained
- Cemented Sand

**Legend**

- CCS (Cont. sensitive clay like)
- CC (Cont. clay like)
- TC (Cont. transitional)
- SC (Cont. sand like)
- CD (Dil. clay like)
- TD (Dil. transitional)
- SD (Dil. sand like)





**Depth Ranges**

- >0.0 to 5.0 ft
- >5.0 to 10.0 ft
- >10.0 to 15.0 ft
- >15.0 to 20.0 ft
- >20.0 to 25.0 ft
- >25.0 to 30.0 ft
- >30.0 to 35.0 ft
- >35.0 to 40.0 ft
- >40.0 to 45.0 ft
- >45.0 to 50.0 ft
- >50.0 ft

**Legend**

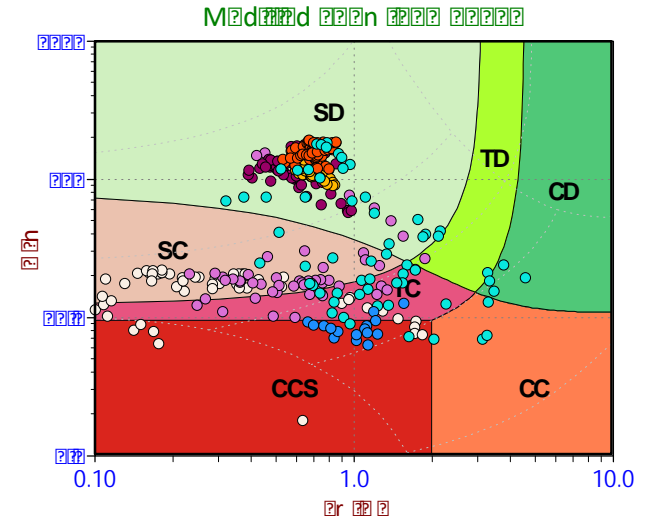
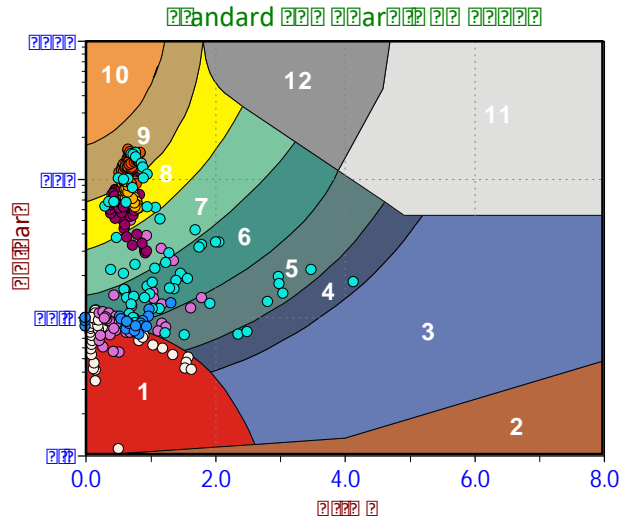
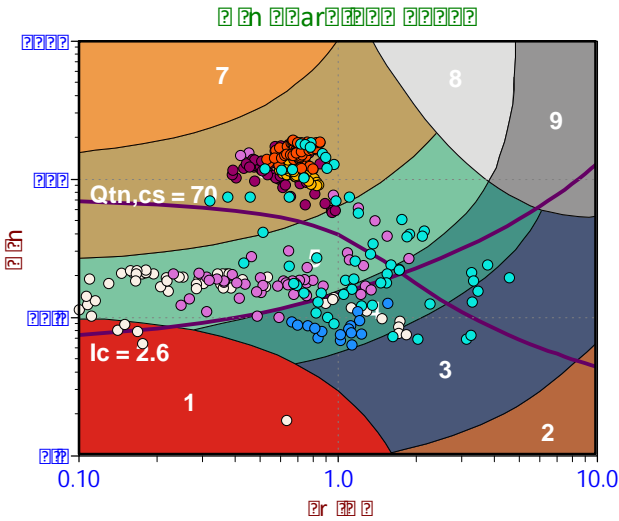
- Sensitive, Fine Grained
- Organic Soils
- Clays
- Silt Mixtures
- Sand Mixtures
- Sands
- Gravelly Sand to Sand
- Stiff Sand to Clayey Sand
- Very Stiff Fine Grained

**Legend**

- Sensitive Fines
- Organic Soil
- Clay
- Silty Clay
- Clayey Silt
- Silt
- Sandy Silt
- Silty Sand/Sand
- Sand
- Gravelly Sand
- Stiff Fine Grained
- Cemented Sand

**Legend**

- CCS (Cont. sensitive clay like)
- CC (Cont. clay like)
- TC (Cont. transitional)
- SC (Cont. sand like)
- CD (Dil. clay like)
- TD (Dil. transitional)
- SD (Dil. sand like)



**Depth Ranges**

- >0.0 to 5.0 ft
- >5.0 to 10.0 ft
- >10.0 to 15.0 ft
- >15.0 to 20.0 ft
- >20.0 to 25.0 ft
- >25.0 to 30.0 ft
- >30.0 to 35.0 ft
- >35.0 to 40.0 ft
- >40.0 to 45.0 ft
- >45.0 to 50.0 ft
- >50.0 ft

**Legend**

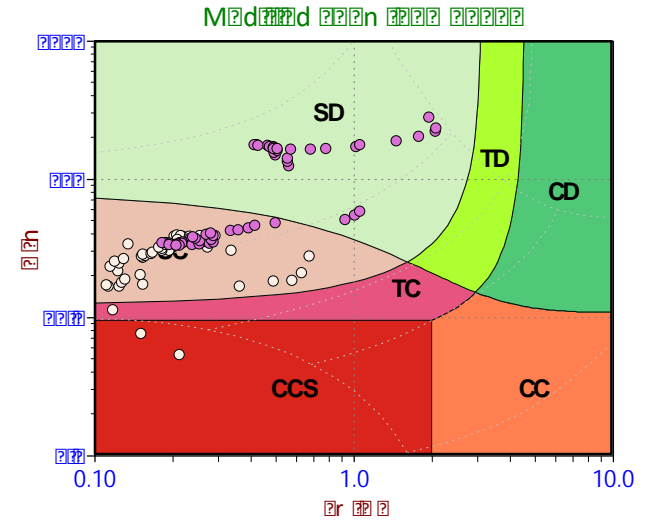
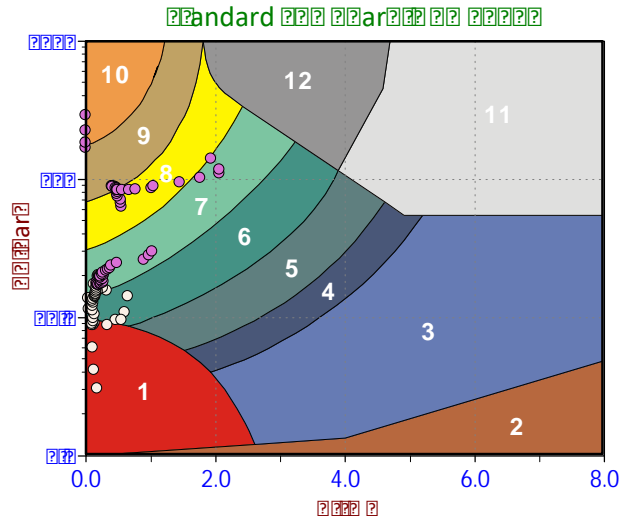
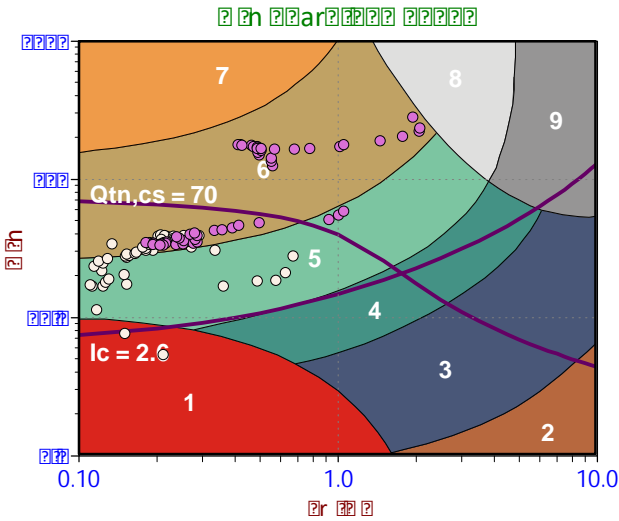
- Sensitive, Fine Grained
- Organic Soils
- Clays
- Silt Mixtures
- Sand Mixtures
- Sands
- Gravelly Sand to Sand
- Stiff Sand to Clayey Sand
- Very Stiff Fine Grained

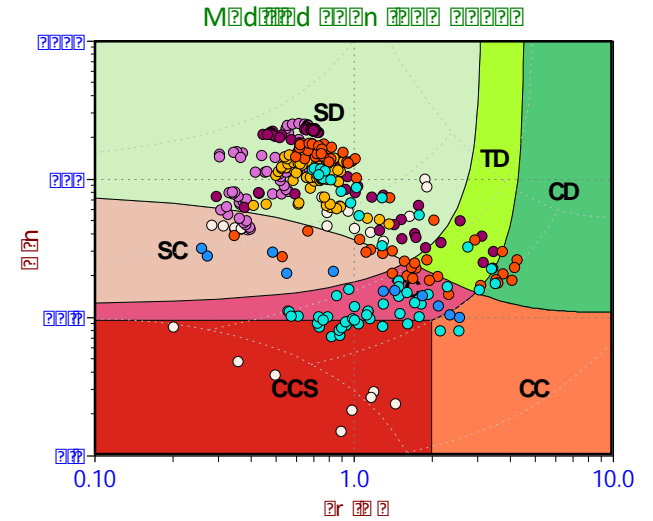
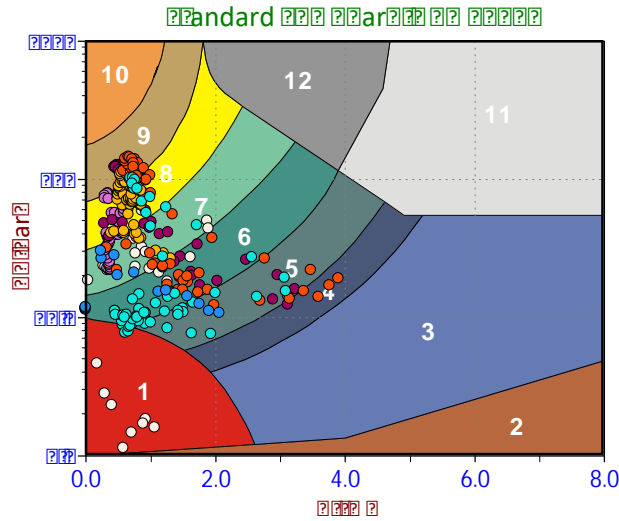
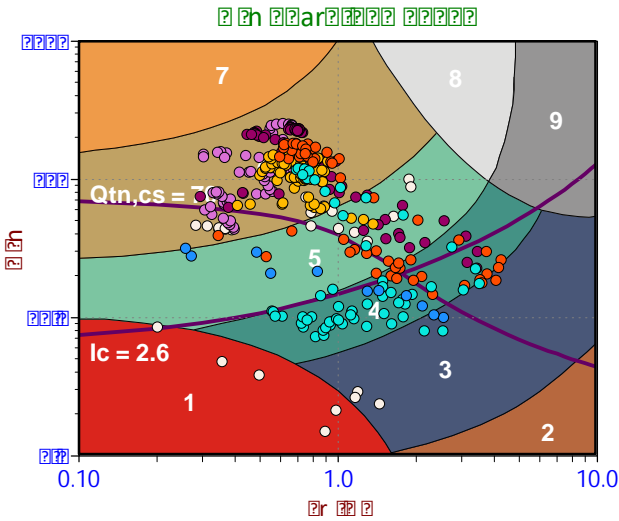
**Legend**

- Sensitive Fines
- Organic Soil
- Clay
- Silty Clay
- Clayey Silt
- Silt
- Sandy Silt
- Silty Sand/Sand
- Sand
- Gravelly Sand
- Stiff Fine Grained
- Cemented Sand

**Legend**

- CCS (Cont. sensitive clay like)
- CC (Cont. clay like)
- TC (Cont. transitional)
- SC (Cont. sand like)
- CD (Dil. clay like)
- TD (Dil. transitional)
- SD (Dil. sand like)





**Depth Ranges**

- >0.0 to 5.0 ft
- >5.0 to 10.0 ft
- >10.0 to 15.0 ft
- >15.0 to 20.0 ft
- >20.0 to 25.0 ft
- >25.0 to 30.0 ft
- >30.0 to 35.0 ft
- >35.0 to 40.0 ft
- >40.0 to 45.0 ft
- >45.0 to 50.0 ft
- >50.0 ft

**Legend**

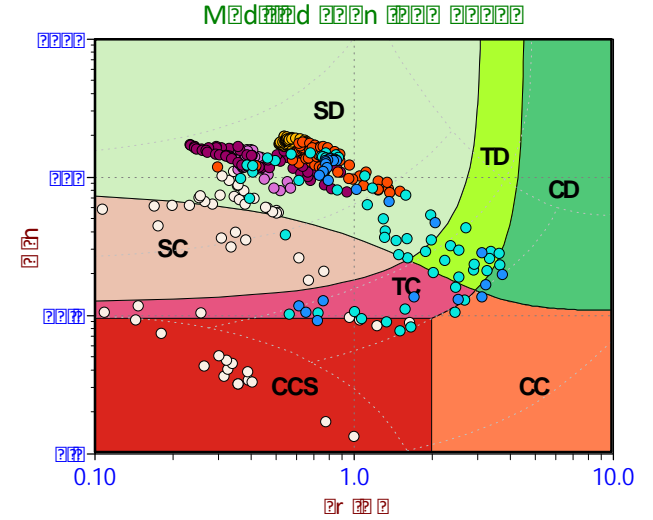
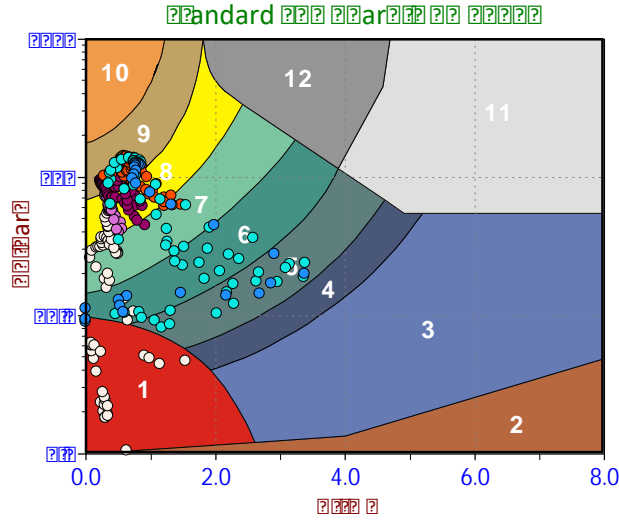
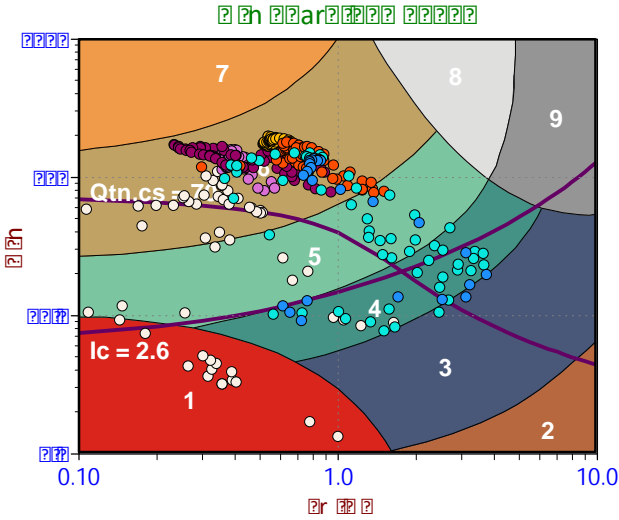
- Sensitive, Fine Grained
- Organic Soils
- Clays
- Silt Mixtures
- Sand Mixtures
- Sands
- Gravelly Sand to Sand
- Stiff Sand to Clayey Sand
- Very Stiff Fine Grained

**Legend**

- Sensitive Fines
- Organic Soil
- Clay
- Silty Clay
- Clayey Silt
- Silt
- Sandy Silt
- Silty Sand/Sand
- Sand
- Gravelly Sand
- Stiff Fine Grained
- Cemented Sand

**Legend**

- CCS (Cont. sensitive clay like)
- CC (Cont. clay like)
- TC (Cont. transitional)
- SC (Cont. sand like)
- CD (Dil. clay like)
- TD (Dil. transitional)
- SD (Dil. sand like)



**Depth Ranges**

- >0.0 to 5.0 ft
- >5.0 to 10.0 ft
- >10.0 to 15.0 ft
- >15.0 to 20.0 ft
- >20.0 to 25.0 ft
- >25.0 to 30.0 ft
- >30.0 to 35.0 ft
- >35.0 to 40.0 ft
- >40.0 to 45.0 ft
- >45.0 to 50.0 ft
- >50.0 ft

**Legend**

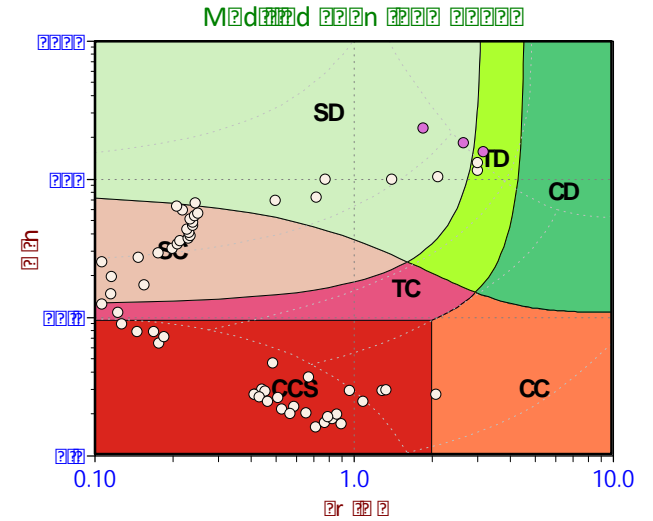
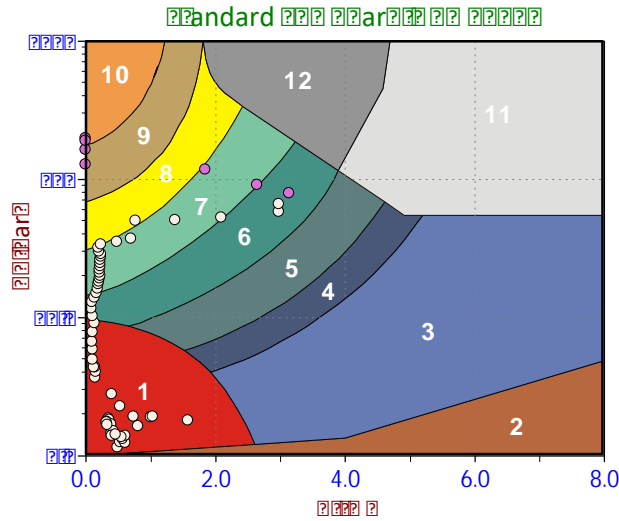
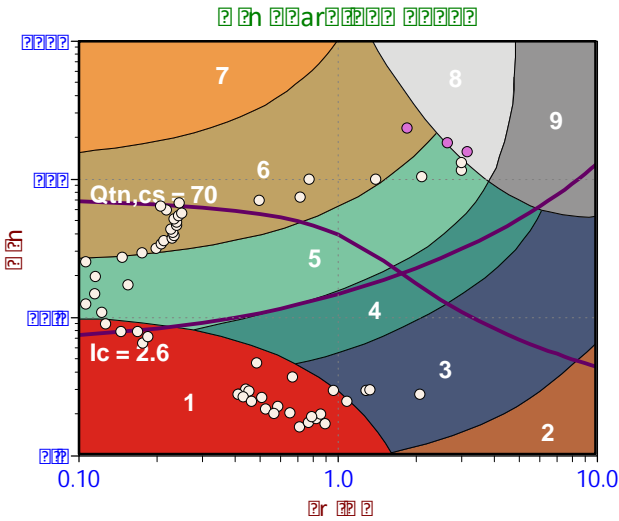
- Sensitive, Fine Grained
- Organic Soils
- Clays
- Silt Mixtures
- Sand Mixtures
- Sands
- Gravelly Sand to Sand
- Stiff Sand to Clayey Sand
- Very Stiff Fine Grained

**Legend**

- Sensitive Fines
- Organic Soil
- Clay
- Silty Clay
- Clayey Silt
- Silt
- Sandy Silt
- Silty Sand/Sand
- Sand
- Gravelly Sand
- Stiff Fine Grained
- Cemented Sand

**Legend**

- CCS (Cont. sensitive clay like)
- CC (Cont. clay like)
- TC (Cont. transitional)
- SC (Cont. sand like)
- CD (Dil. clay like)
- TD (Dil. transitional)
- SD (Dil. sand like)



### Depth Ranges

- >0.0 to 5.0 ft
- >5.0 to 10.0 ft
- >10.0 to 15.0 ft
- >15.0 to 20.0 ft
- >20.0 to 25.0 ft
- >25.0 to 30.0 ft
- >30.0 to 35.0 ft
- >35.0 to 40.0 ft
- >40.0 to 45.0 ft
- >45.0 to 50.0 ft
- >50.0 ft

### Legend

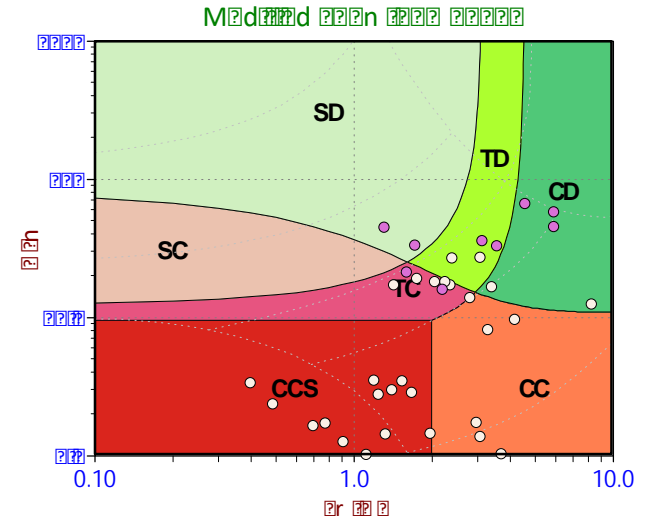
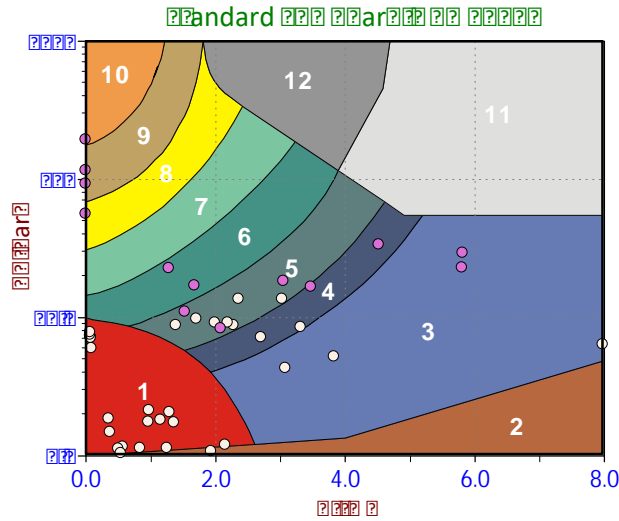
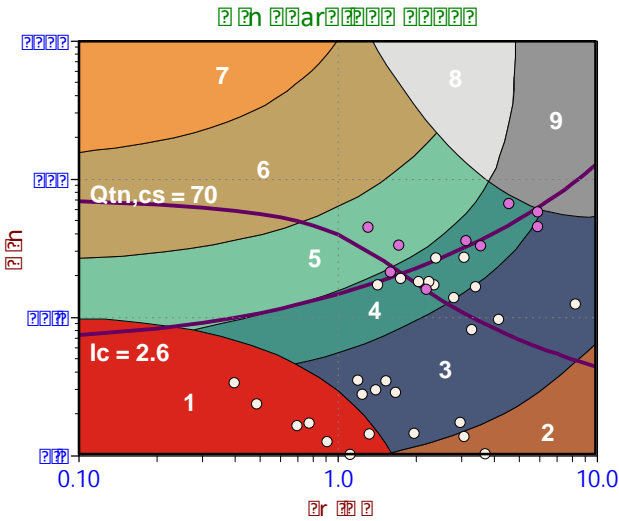
- Sensitive, Fine Grained
- Organic Soils
- Clays
- Silt Mixtures
- Sand Mixtures
- Sands
- Gravelly Sand to Sand
- Stiff Sand to Clayey Sand
- Very Stiff Fine Grained

### Legend

- Sensitive Fines
- Organic Soil
- Clay
- Silty Clay
- Clayey Silt
- Silt
- Sandy Silt
- Silty Sand/Sand
- Sand
- Gravelly Sand
- Stiff Fine Grained
- Cemented Sand

### Legend

- CCS (Cont. sensitive clay like)
- CC (Cont. clay like)
- TC (Cont. transitional)
- SC (Cont. sand like)
- CD (Dil. clay like)
- TD (Dil. transitional)
- SD (Dil. sand like)



**Depth Ranges**

- >0.0 to 5.0 ft
- >5.0 to 10.0 ft
- >10.0 to 15.0 ft
- >15.0 to 20.0 ft
- >20.0 to 25.0 ft
- >25.0 to 30.0 ft
- >30.0 to 35.0 ft
- >35.0 to 40.0 ft
- >40.0 to 45.0 ft
- >45.0 to 50.0 ft
- >50.0 ft

**Legend**

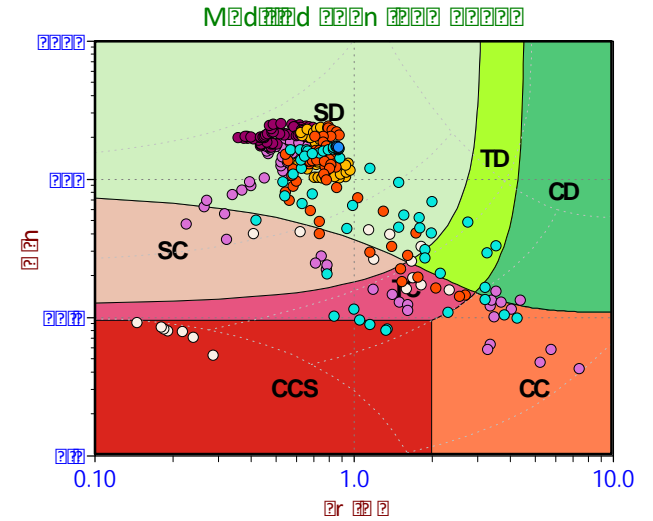
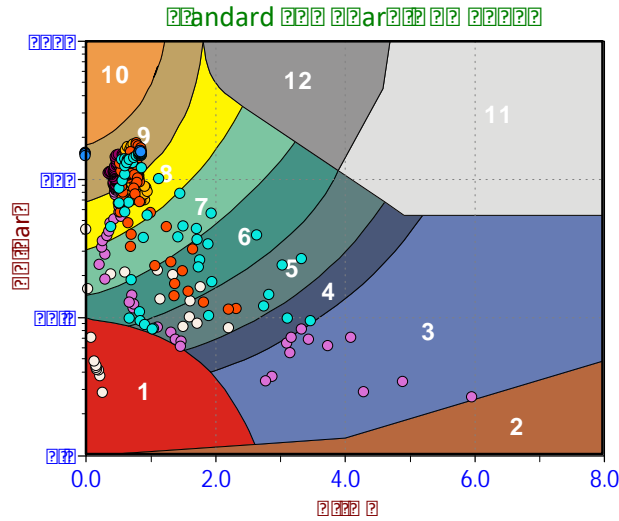
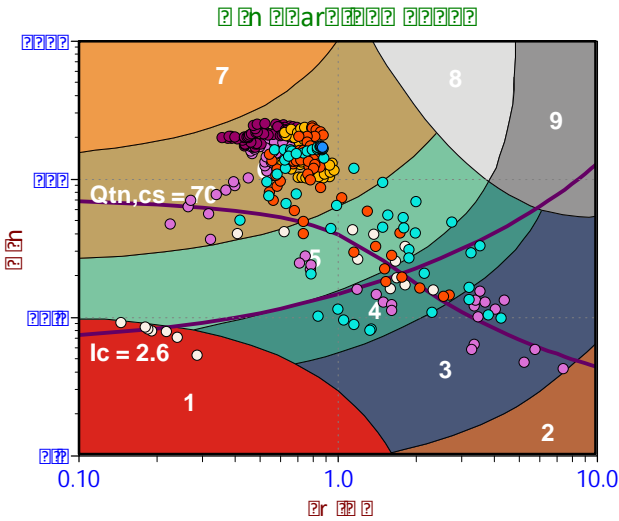
- Sensitive, Fine Grained
- Organic Soils
- Clays
- Silt Mixtures
- Sand Mixtures
- Sands
- Gravelly Sand to Sand
- Stiff Sand to Clayey Sand
- Very Stiff Fine Grained

**Legend**

- Sensitive Fines
- Organic Soil
- Clay
- Silty Clay
- Clayey Silt
- Silt
- Sandy Silt
- Silty Sand/Sand
- Sand
- Gravelly Sand
- Stiff Fine Grained
- Cemented Sand

**Legend**

- CCS (Cont. sensitive clay like)
- CC (Cont. clay like)
- TC (Cont. transitional)
- SC (Cont. sand like)
- CD (Dil. clay like)
- TD (Dil. transitional)
- SD (Dil. sand like)



**Depth Ranges**

- >0.0 to 5.0 ft
- >5.0 to 10.0 ft
- >10.0 to 15.0 ft
- >15.0 to 20.0 ft
- >20.0 to 25.0 ft
- >25.0 to 30.0 ft
- >30.0 to 35.0 ft
- >35.0 to 40.0 ft
- >40.0 to 45.0 ft
- >45.0 to 50.0 ft
- >50.0 ft

**Legend**

- Sensitive, Fine Grained
- Organic Soils
- Clays
- Silt Mixtures
- Sand Mixtures
- Sands
- Gravelly Sand to Sand
- Stiff Sand to Clayey Sand
- Very Stiff Fine Grained

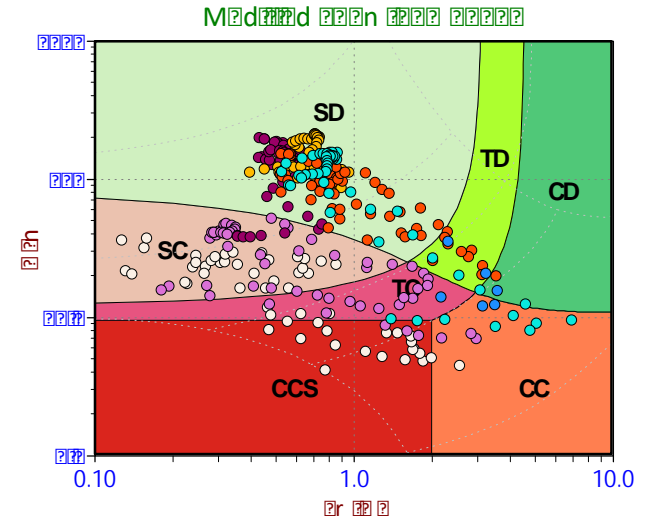
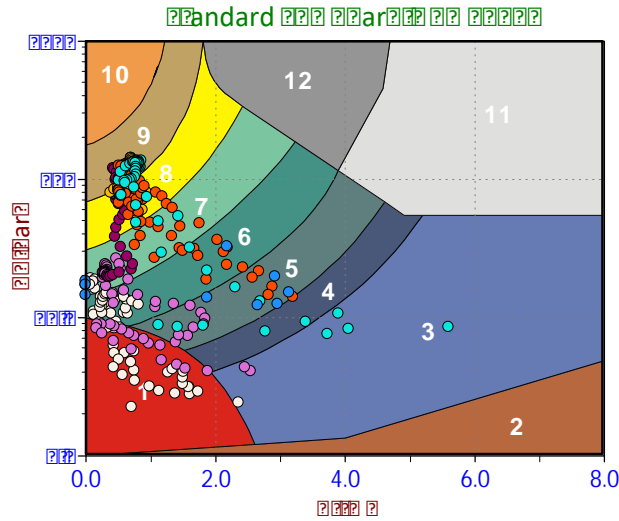
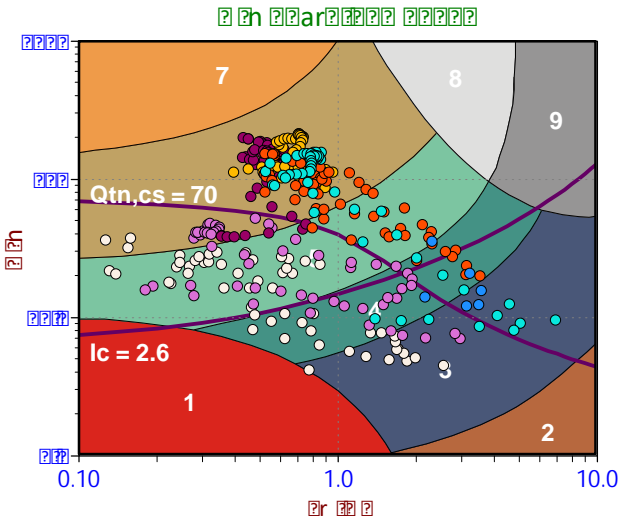
**Legend**

- Sensitive Fines
- Organic Soil
- Clay
- Silty Clay
- Clayey Silt
- Silt
- Sandy Silt
- Silty Sand/Sand
- Sand
- Gravelly Sand
- Stiff Fine Grained
- Cemented Sand

**Legend**

- CCS (Cont. sensitive clay like)
- CC (Cont. clay like)
- TC (Cont. transitional)
- SC (Cont. sand like)
- CD (Dil. clay like)
- TD (Dil. transitional)
- SD (Dil. sand like)





**Depth Ranges**

- >0.0 to 5.0 ft
- >5.0 to 10.0 ft
- >10.0 to 15.0 ft
- >15.0 to 20.0 ft
- >20.0 to 25.0 ft
- >25.0 to 30.0 ft
- >30.0 to 35.0 ft
- >35.0 to 40.0 ft
- >40.0 to 45.0 ft
- >45.0 to 50.0 ft
- >50.0 ft

**Legend**

- Sensitive, Fine Grained
- Organic Soils
- Clays
- Silt Mixtures
- Sand Mixtures
- Sands
- Gravelly Sand to Sand
- Stiff Sand to Clayey Sand
- Very Stiff Fine Grained

**Legend**

- Sensitive Fines
- Organic Soil
- Clay
- Silty Clay
- Clayey Silt
- Silt
- Sandy Silt
- Silty Sand/Sand
- Sand
- Gravelly Sand
- Stiff Fine Grained
- Cemented Sand

**Legend**

- CCS (Cont. sensitive clay like)
- CC (Cont. clay like)
- TC (Cont. transitional)
- SC (Cont. sand like)
- CD (Dil. clay like)
- TD (Dil. transitional)
- SD (Dil. sand like)

## Ball Full Flow Cone Penetration Test Summary and Plots



Job No: 21-59-22445  
Client: Anchor QEA  
Project: LDW Phase 3  
Start Date: 06-Jul-2021  
End Date: 29-Jul-2021

**BALL FULL FLOW PENETRATION TEST SUMMARY**

Sounding ID	File Name	Date	Cone	Cone Area (cm <sup>2</sup> )	Ball Area (cm <sup>2</sup> )	Final Depth (ft)	Cycling Conducted	Latitude <sup>1</sup> (deg)	Longitude <sup>1</sup> (deg)	Refer to Notation Number
LDW21-GT01-FFP	21-59-22445_BP01	14-Jul-2021	681:T375F10U35	15	150	4.0	YES	47.53230	-122.31937	
LDW21-GT03-FFP	21-59-22445_BP03	14-Jul-2021	681:T375F10U35	15	150	5.9	YES	47.52757	-122.31136	
LDW21-GT09-FFP	21-59-22445_BP09	14-Jul-2021	681:T375F10U35	15	150	12.1	YES			2
LDW21-GT11-FFP	21-59-22445_BP11	16-Jul-2021	681:T375F10U35	15	150	9.4	YES	47.52623	-122.30963	
LDW21-GT26-FFP	21-59-22445_BP26	16-Jul-2021	681:T375F10U35	15	150	4.0	YES	47.52150	-122.30687	
LDW21-GT30-31-FFP	21-59-22445_BP30-31	21-Jul-2021	681:T375F10U35	15	150	5.2	YES	47.52051	-122.30581	
LDW21-GT32-34-FFP	21-59-22445_BP32-34	21-Jul-2021	681:T375F10U35	15	150	4.0	YES	47.51999	-122.30585	

- 1. Coordinates were provided by client
- 2. Coordinates currently not available. Coordinates will be provided by client at a later date

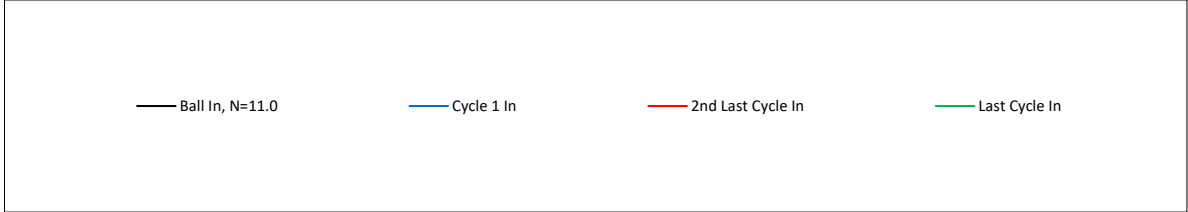
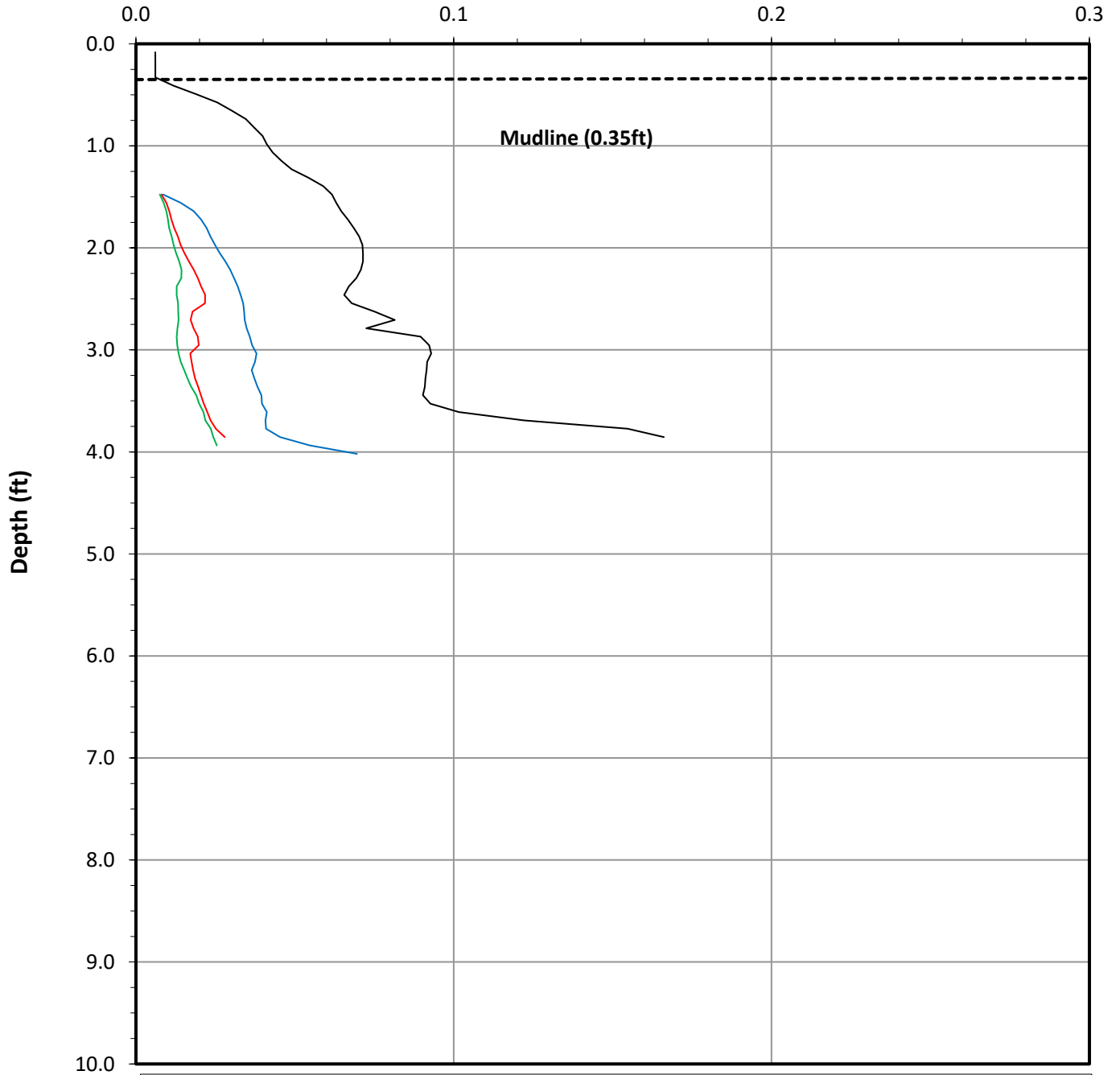


Job No: 21-59-22445  
Client: Anchor QEA  
Project: LDW Phase 3  
Sounding ID: LDW21-GT01-FFP  
Sounding Date: July 14, 2021

Coordinate System: WGS 84 Lat/Long  
Lat (deg): 47.5322979  
Long (deg): -122.3193655

### Flow Penetrometer Undrained Strength

Su (tsf)



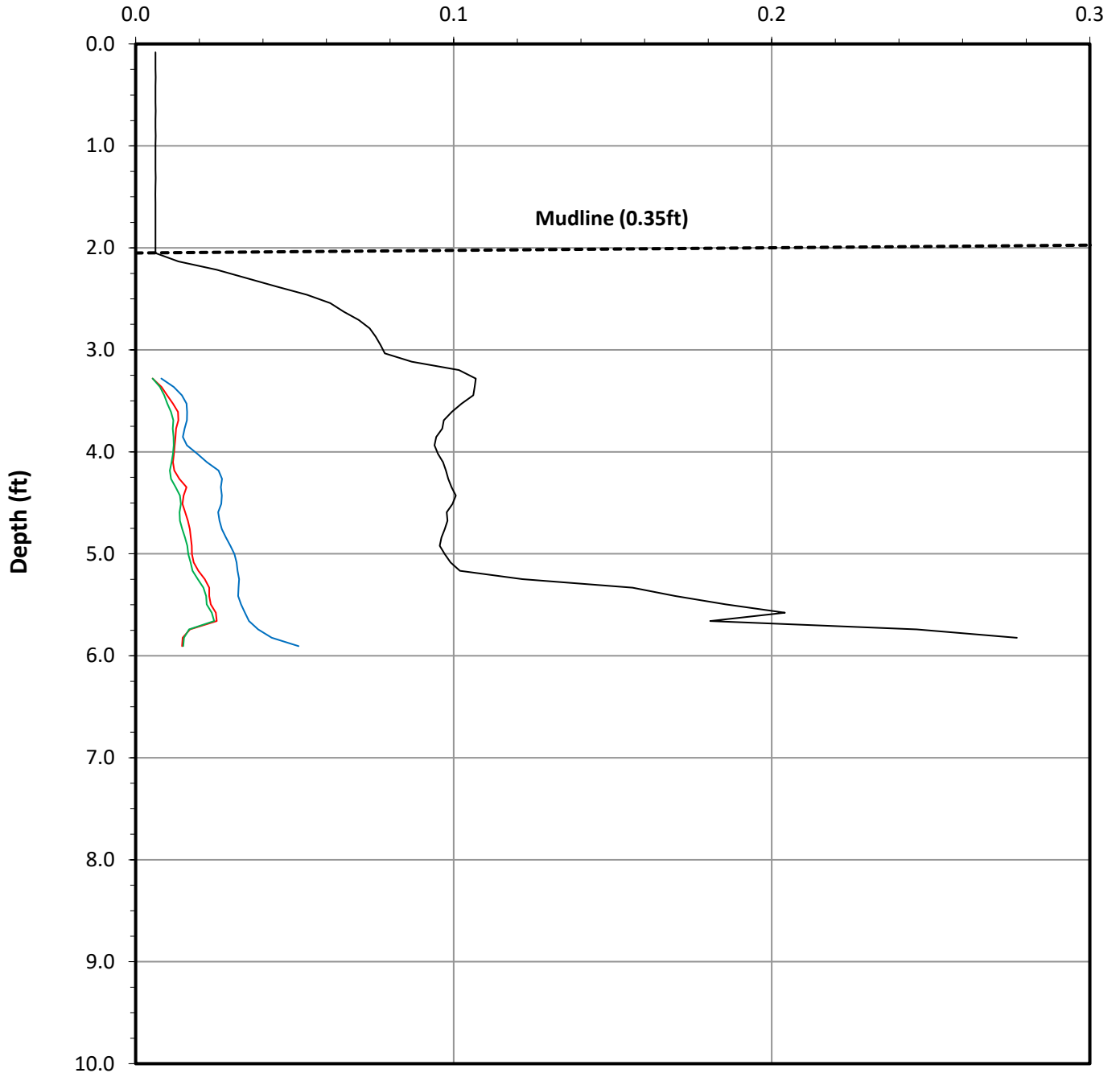


Job No: 21-59-22445  
Client: Anchor QEA  
Project: LDW Phase 3  
Sounding ID: LDW21-GT03-FFP  
Sounding Date: July 14, 2021

Coordinate System: WGS 84 Lat/Long  
Lat (deg): 47.5275718  
Long (deg): -122.3113628

### Flow Penetrometer Undrained Strength

Su (tsf)



Ball In, N=11.0

Cycle 1 In

2nd Last Cycle In

Last Cycle In

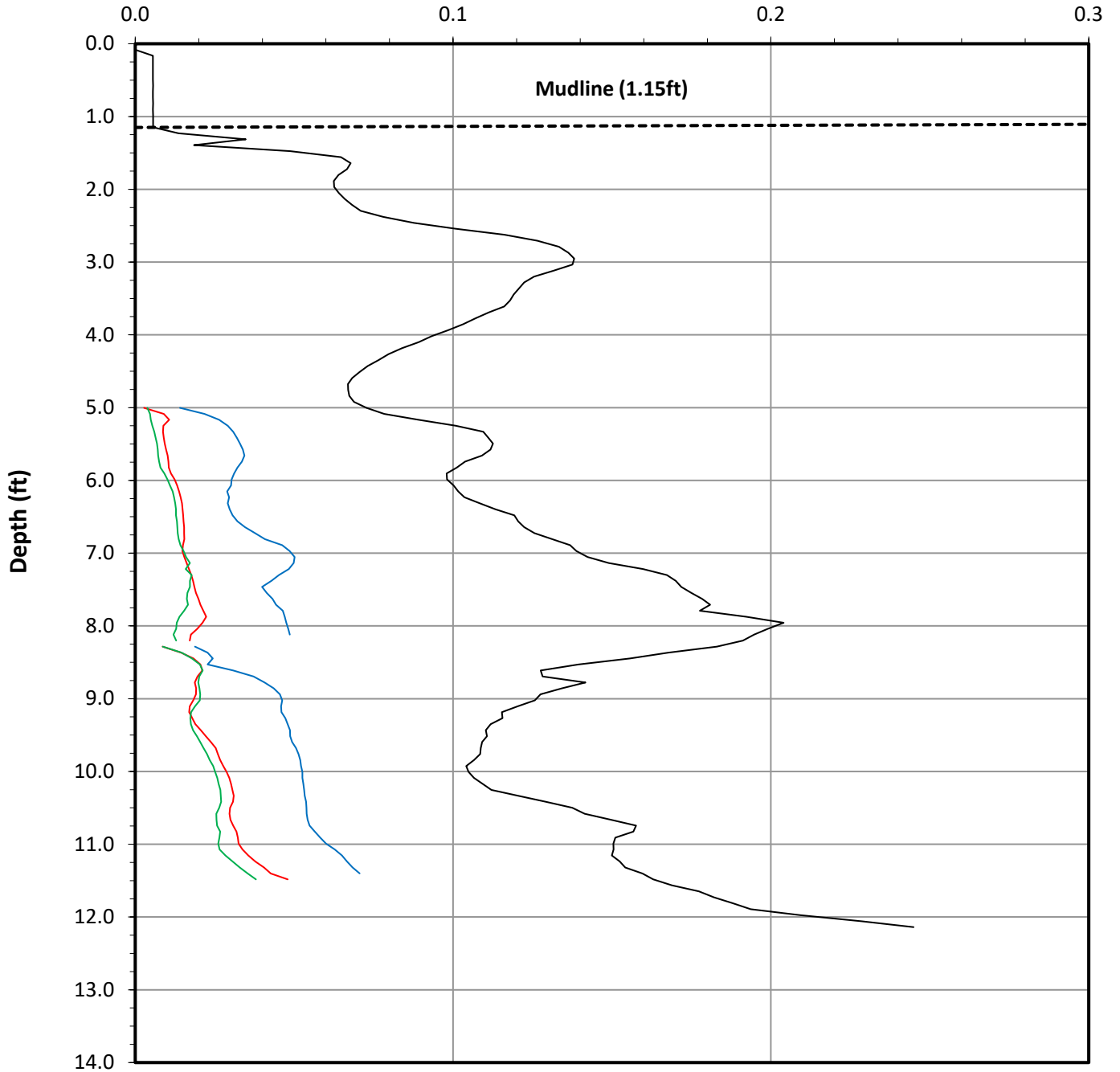


Job No: 21-59-22445  
Client: Anchor QEA  
Project: LDW Phase 3  
Sounding ID: LDW21-GT09-FFP  
Sounding Date: July 14, 2021

Coordinate System: WGS 84 Lat/Long  
Lat (deg):  
Long (deg):

### Flow Penetrometer Undrained Strength

Su (tsf)



— Ball In, N=11.0

— Cycle 1 In

— 2nd Last Cycle In

— Last Cycle In

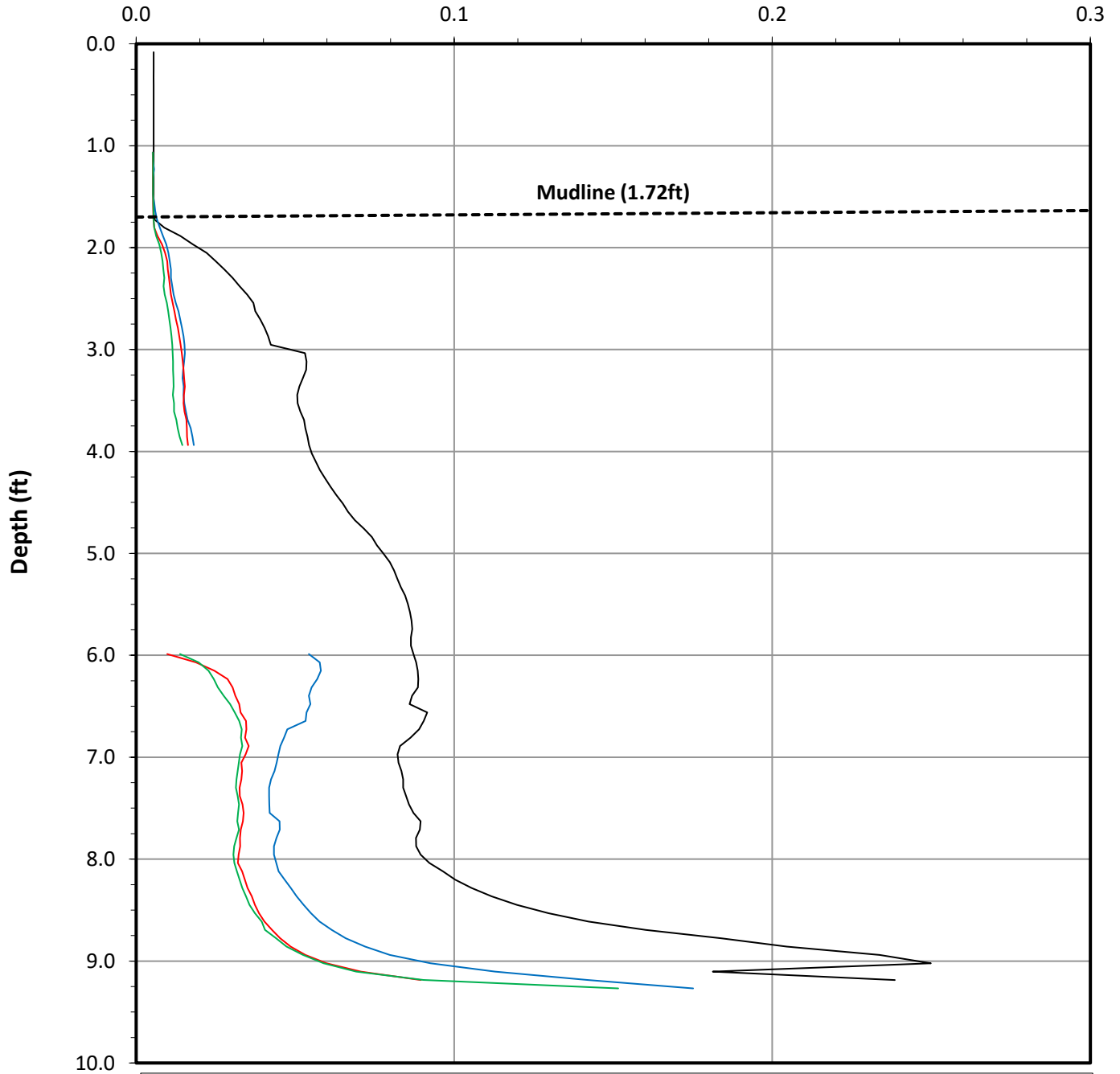


Job No: 21-59-22445  
Client: Anchor QEA  
Project: LDW Phase 3  
Sounding ID: LDW21-GT11-FFP  
Sounding Date: July 16, 2021

Coordinate System: WGS 84 Lat/Long  
Lat (deg): 47.5262259  
Long (deg): -122.3096315

### Flow Penetrometer Undrained Strength

Su (tsf)



— Ball In, N=11.0

— Cycle 1 In

— 2nd Last Cycle In

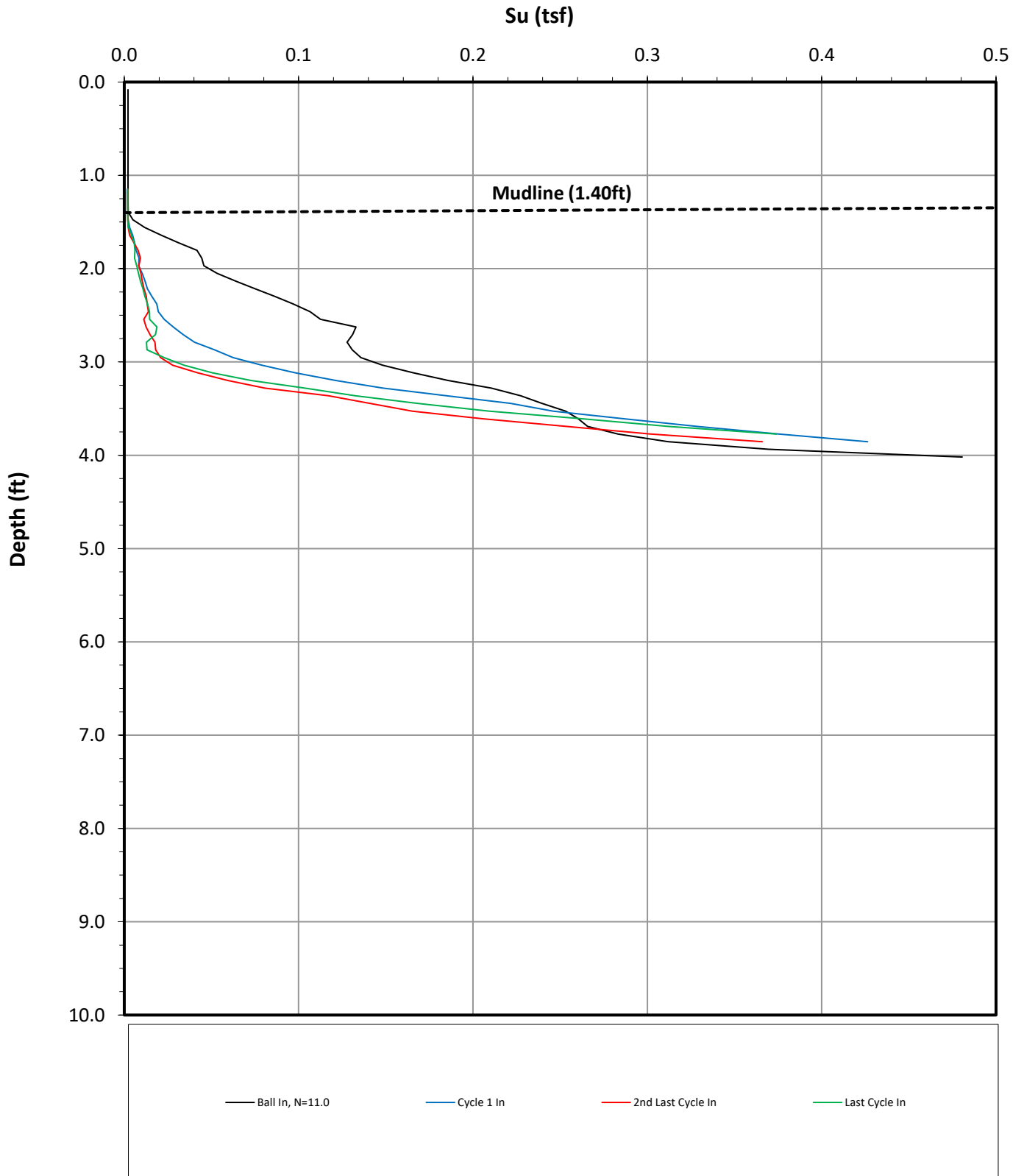
— Last Cycle In



Job No: 21-59-22445  
Client: Anchor QEA  
Project: LDW Phase 3  
Sounding ID: LDW21-GT26-FFP  
Sounding Date: July 16, 2021

Coordinate System: WGS 84 Lat/Long  
Lat (deg): 47.5215043  
Long (deg): -122.3068749

### Flow Penetrometer Undrained Strength



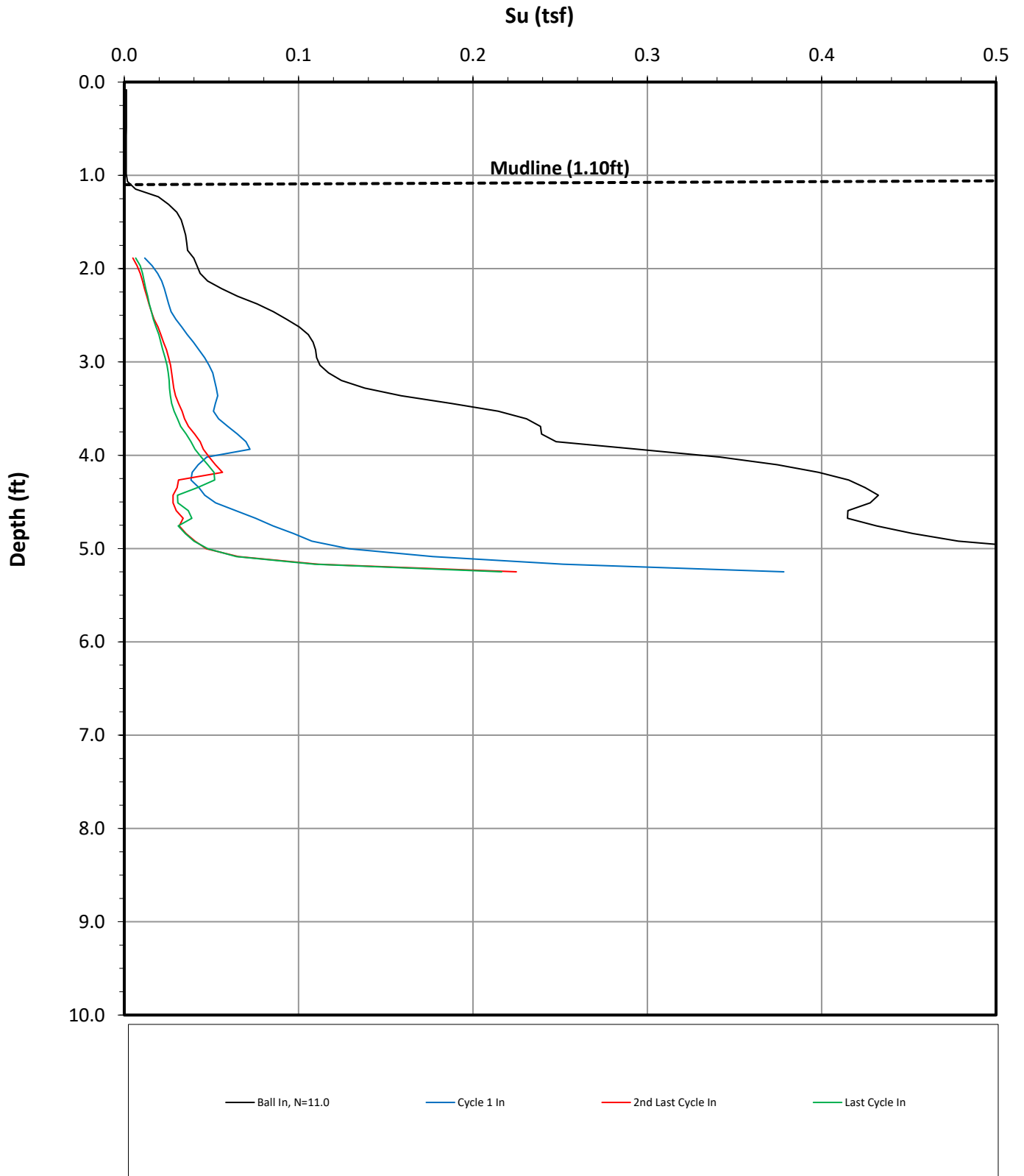




Job No: 21-59-22445  
Client: Anchor QEA  
Project: LDW Phase 3  
Sounding ID: LDW21-GT30-31-FFP  
Sounding Date: July 21, 2021

Coordinate System: WGS 84 Lat/Long  
Lat (deg): 47.520508  
Long (deg): -122.3058147

### Flow Penetrometer Undrained Strength

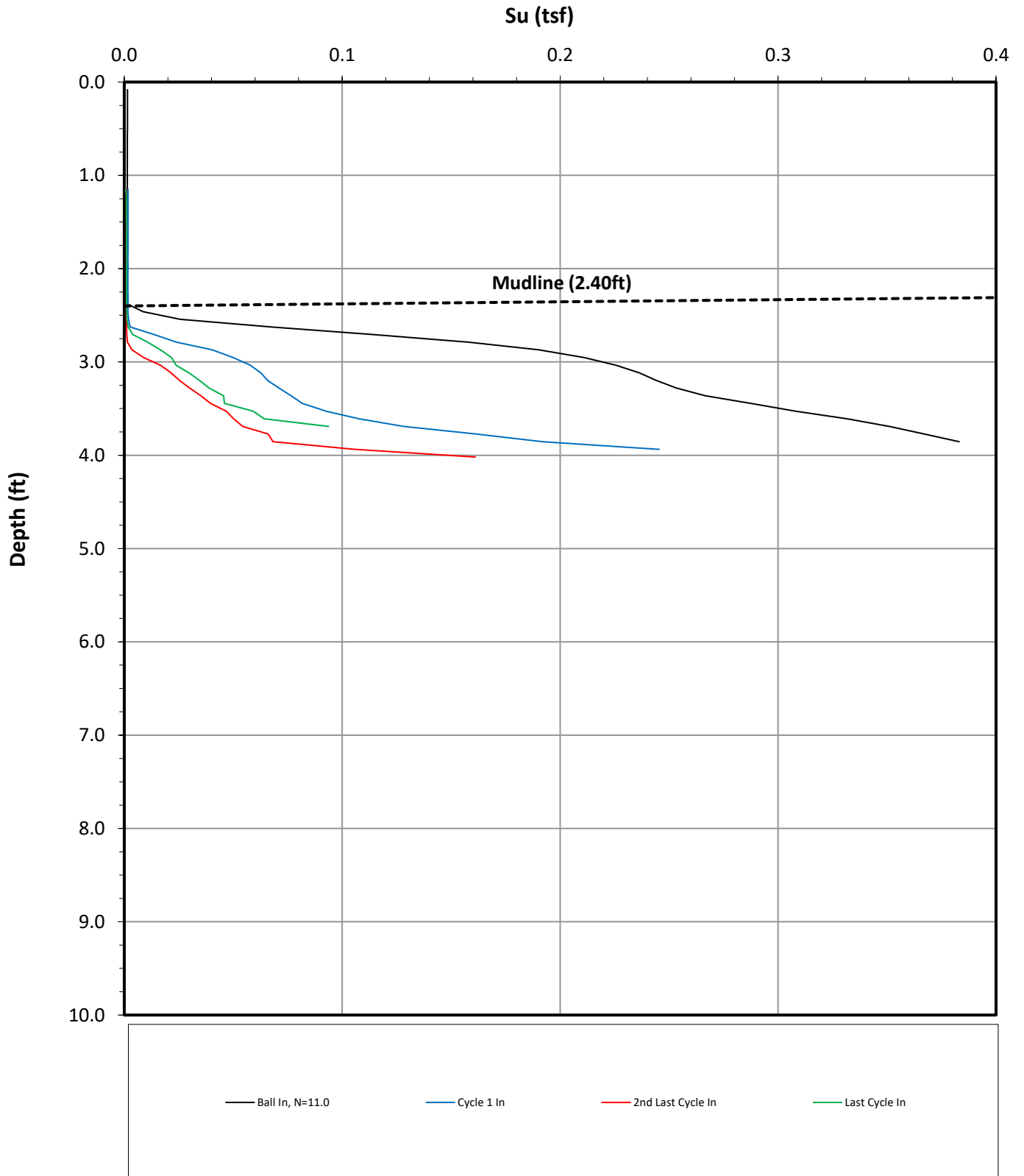




Job No: 21-59-22445  
Client: Anchor QEA  
Project: LDW Phase 3  
Sounding ID: LDW21-GT32-34-FFP  
Sounding Date: July 21, 2021

Coordinate System: WGS 84 Lat/Long  
Lat (deg): 47.5199896  
Long (deg): -122.3058465

### Flow Penetrometer Undrained Strength



Electronic Field Vane Shear Test Profile Summary and Results





Job Number: 21-59-22445  
Client: Anchor QEA  
Project: LDW Phase 3  
Start Date: 06-Jul-2021  
End Date: 29-Jul-2021

### **ELECTRIC FIELD VANE SHEAR TEST SUMMARY**

Sounding ID	File Name	Adjacent CPT Sounding ID	Rig	Date From	Date To	Latitude <sup>1</sup>	Longitude <sup>1</sup>	Refer to Notation Number
LDW21-GT04-GV	21-59-22445_VST04	NONE	C05-023	12-Jul-2021	12-Jul-2021			2
LDW21-GT20-GV	21-59-22445_VST20	NONE	C05-023	19-Jul-2021	19-Jul-2021			2
LDW21-GT-26-GV	21-59-22445_VST26	NONE	C05-023	07-Jul-2021	07-Jul-2021	47.521510	-122.306837	
LDW21-GT-26-GV-B	21-59-22445_VST26B	NONE	C05-023	07-Jul-2021	07-Jul-2021	47.521522	-122.306805	
LDW21-GT43-GV	21-59-22445_VST43	NONE	C05-023	22-Jul-2021	22-Jul-2021	47.511105	-122.303294	

1. Coordinates were provided by client
2. Coordinates currently not available. Coordinates will be provided by client at a later date
3. Test depth reference depth below mudline.
4. All vane tests were completed from the floating barge platform. The vane test results were affected by barge movement from local waves, local vessel traffic and river flow. Additionally, the vane results were susceptible to elevation change from either rising or falling tide. Over the course of a vane test the barge would gain/lose approximately 1"-4" of elevation due to tidal effects.



Job Number: 21-59-22445  
 Client: Anchor QEA  
 Project: LDW Phase 3  
 Start Date: 06-Jul-2021  
 End Date: 29-Jul-2021

**ELECTRIC FIELD VANE SHEAR TEST RESULTS**

Sounding ID	File Name	Date	Load Cell Serial Number	Load Cell Location	Casing/Drillout Depth (ft)	Test Depth <sup>1</sup> (ft)	Vane Diameter D (mm)	Vane Height H (mm)	Top Taper Angle i <sub>r</sub> (deg)	Bottom Taper Angle i <sub>b</sub> (deg)	Vane Factor (kPa/Nm)	Peak Torque (Nm)	Remolded Torque (Nm)	Peak Stress (tsf)	Remolded Stress (tsf)	Peak Frictional Stress (tsf)	Remolded Frictional Stress (tsf)	Su Peak (tsf)	Su Remolded (tsf)	Sensitivity	Refer to Notation Number
LDW21-GT04-GV	21-59-22445_VST04	12-Jul-2021	AVLC009	Surface	N/A	1.50	75	150	45	45	0.6106	10.28		0.07		0.003		0.06			
LDW21-GT04-GV	21-59-22445_VST04	12-Jul-2021	AVLC009	Surface	N/A	2.50	75	150	45	45	0.6106	16.52	2.69	0.11	0.02	0.001	0.002	0.10	0.02	6.83	
LDW21-GT20-GV	21-59-22445_VST20	19-Jul-2021	AVLC009	Surface	N/A	2.50	75	150	45	45	0.6106	67.49	5.27	0.43	0.03	0.003	0.002	0.43	0.03	13.40	
LDW21-GT20-GV	21-59-22445_VST20	19-Jul-2021	AVLC009	Surface	N/A	4.50	75	150	45	45	0.6106	13.50	3.49	0.09	0.02	0.002	0.003	0.08	0.02	4.26	
LDW21-GT-26-GV	21-59-22445_VST26	07-Jul-2021	AVLC013	Surface	N/A	1.17	60	120	45	45	1.1926	3.04	0.47	0.04	0.01	0.004	0.004	0.03	0.00	15.56	
LDW21-GT-26-GV	21-59-22445_VST26	07-Jul-2021	AVLC013	Surface	N/A	3.17	60	120	45	45	1.1926	6.79	2.51	0.08	0.03	0.007	0.008	0.08	0.02	3.36	
LDW21-GT-26-GV	21-59-22445_VST26	07-Jul-2021	AVLC013	Surface	N/A	4.42	60	120	45	45	1.1926	4.23		0.05		0.004		0.05			
LDW21-GT-26-GV-B	21-59-22445_VST26B	07-Jul-2021	AVLC013	Surface	N/A	1.17	75	150	45	45	0.6106	14.96		0.10		0.003		0.09			
LDW21-GT43-GV	21-59-22445_VST43	22-Jul-2021	AVLC009	Surface	N/A	1.08	75	150	45	45	0.6106	43.50	6.22	0.28	0.04	0.003	0.001	0.27	0.04	7.03	
LDW21-GT43-GV	21-59-22445_VST43	22-Jul-2021	AVLC009	Surface	N/A	3.17	75	150	45	45	0.6106	72.29		0.46		0.003		0.46			

1. Test depths are referenced to the middle of the vane.



Job Number: 21-59-22445  
Client: Anchor QEA  
Project: LDW Phase 3  
Start Date: 06-Jul-2021  
End Date: 29-Jul-2021

**ELECTRIC FIELD VANE SHEAR TEST TIMING**

Sounding ID	Date	Test Depth <sup>1</sup> (ft)	Vane Insertion Time (HH:mm)	Peak Test Start Time (HH:mm)	Insertion to Start Interval (min)	Start to Failure Interval (sec)	Peak Test Avg Rate (deg/sec)	Remolding Completion Time (HH:mm)	Remold Test Start Time (HH:mm)	Remolding to Start Interval (min)	Remold Test Avg Rate (deg/sec)	Refer to Notation Number
LDW21-GT04-GV	12-Jul-2021	1.50	17:27	17:27	1	150	0.12					
LDW21-GT04-GV	12-Jul-2021	2.50	18:21	18:23	16	357	0.11	18:32	18:33	27	0.11	
LDW21-GT20-GV	19-Jul-2021	2.50	12:15	12:16	1	686	0.12	12:34	12:35	20	0.11	
LDW21-GT20-GV	19-Jul-2021	4.50	12:49	12:50	36	307	0.11	12:57	12:58	43	0.11	
LDW21-GT-26-GV	07-Jul-2021	1.17	14:08	14:10	2	210	0.08	14:22	14:23	16	0.09	
LDW21-GT-26-GV	07-Jul-2021	3.17	14:33	14:35	28	492	0.08	14:54	14:55	47	0.08	
LDW21-GT-26-GV	07-Jul-2021	4.42	15:08	15:11	63	269	0.08					
LDW21-GT-26-GV-B	07-Jul-2021	1.17	15:57	15:58	1	303	0.10					
LDW21-GT43-GV	22-Jul-2021	1.08	16:06	16:10	4	330	0.12	16:21	16:22	16	0.13	
LDW21-GT43-GV	22-Jul-2021	3.17	16:35	16:36	31	400	0.12					

1. Test depths are referenced to the middle of the vane.

## Electronic Field Vane Shear Test Plots

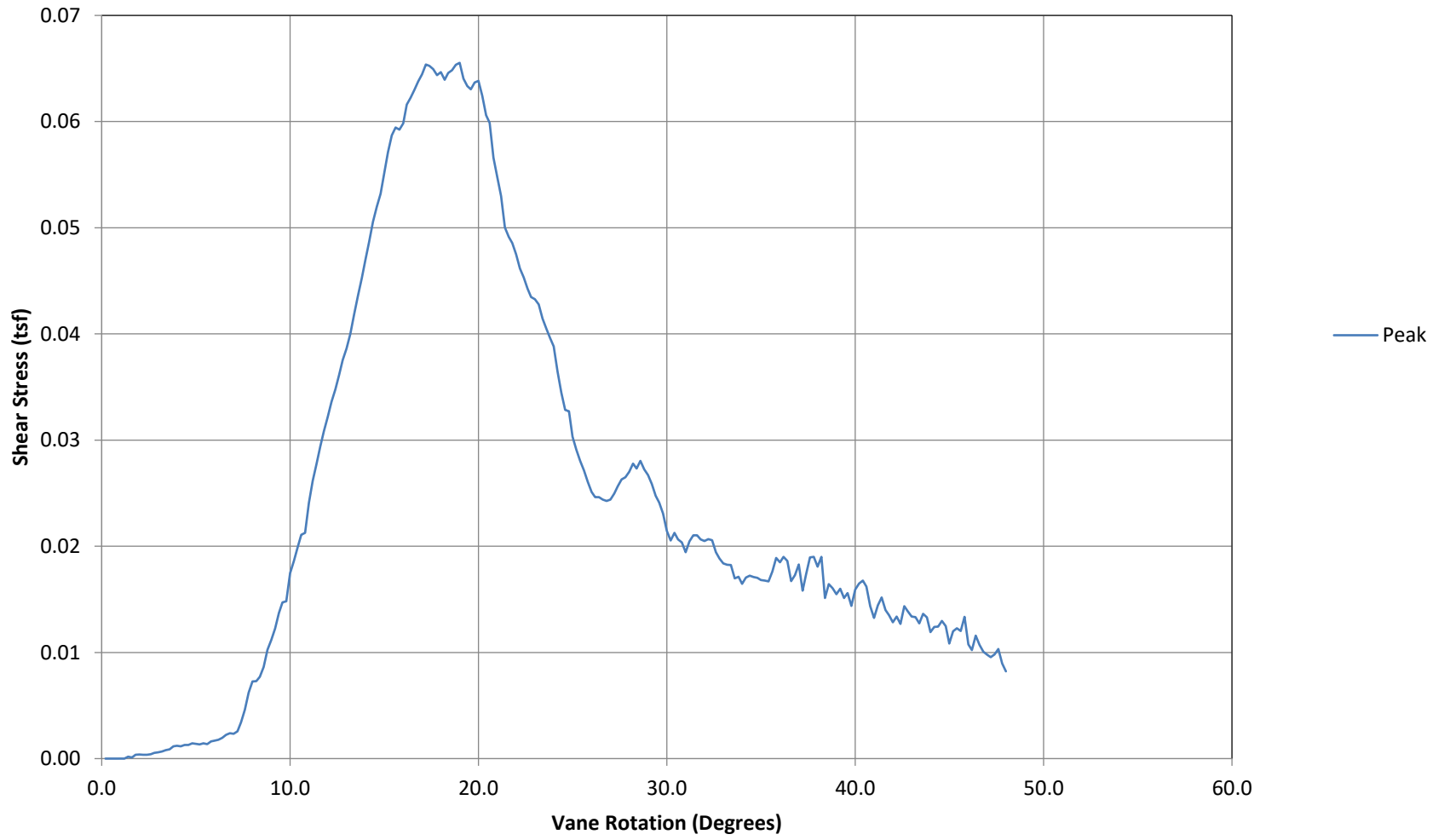


Job Number: 21-59-22445  
Client: Anchor QEA  
Project: LDW Phase 3  
Sounding: LDW21-GT04-GV

Test Date: 12-Jul-2021 17:27  
Test Depth (ft): 1.50  
Vane Type: Adara solid double tapered 75 x 150  
mm (45°, 45°)

Coordinate System: WGS 84 Lat/Long  
Latitude: 0  
Longitude: 0

### Vane Shear Test





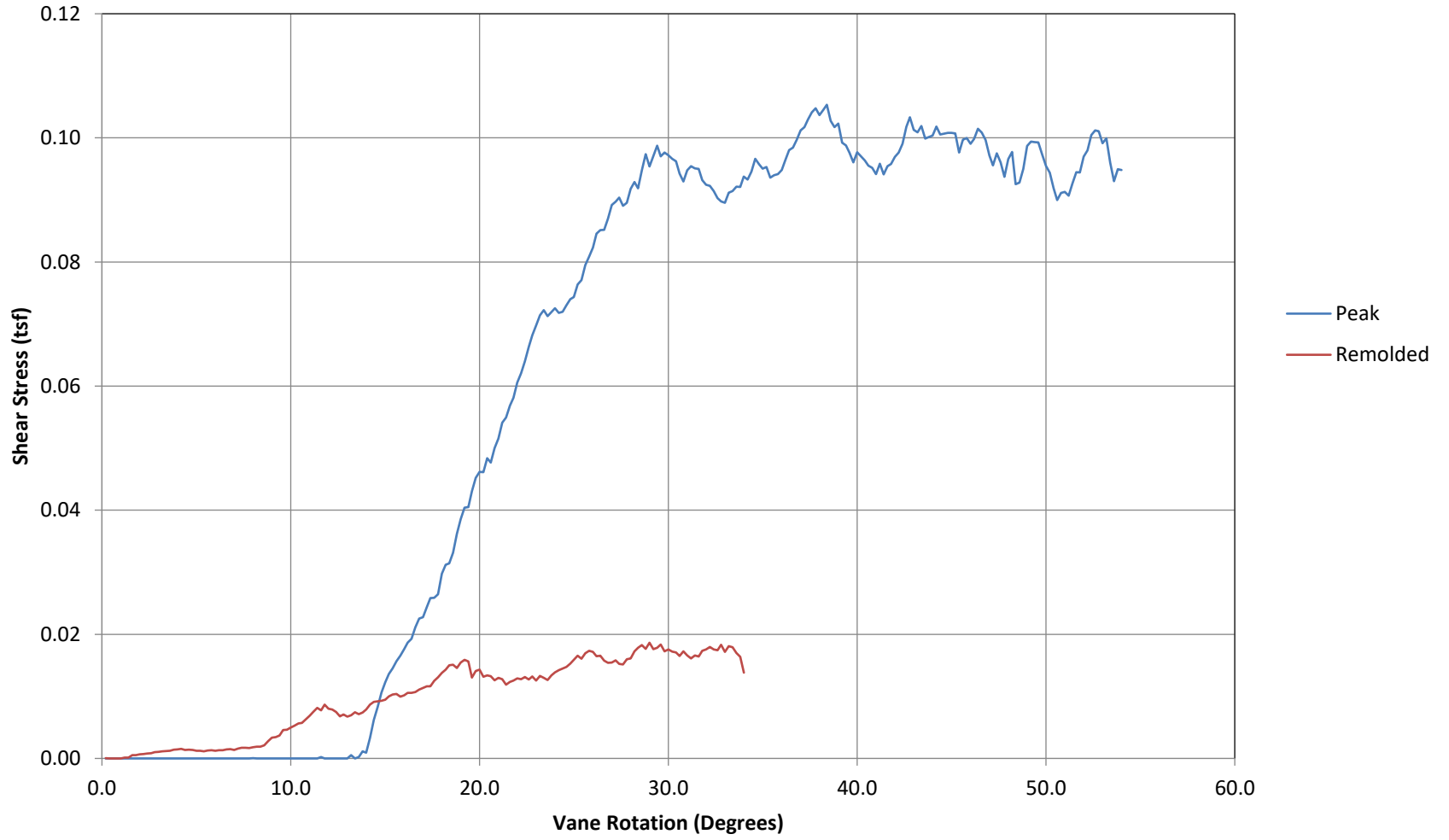


Job Number: 21-59-22445  
Client: Anchor QEA  
Project: LDW Phase 3  
Sounding: LDW21-GT04-GV

Test Date: 12-Jul-2021 18:23  
Test Depth (ft): 2.50  
Vane Type: Adara solid double tapered 75 x 150 mm (45°, 45°)

Coordinate System: WGS 84 Lat/Long  
Latitude: 0  
Longitude: 0

### Vane Shear Test



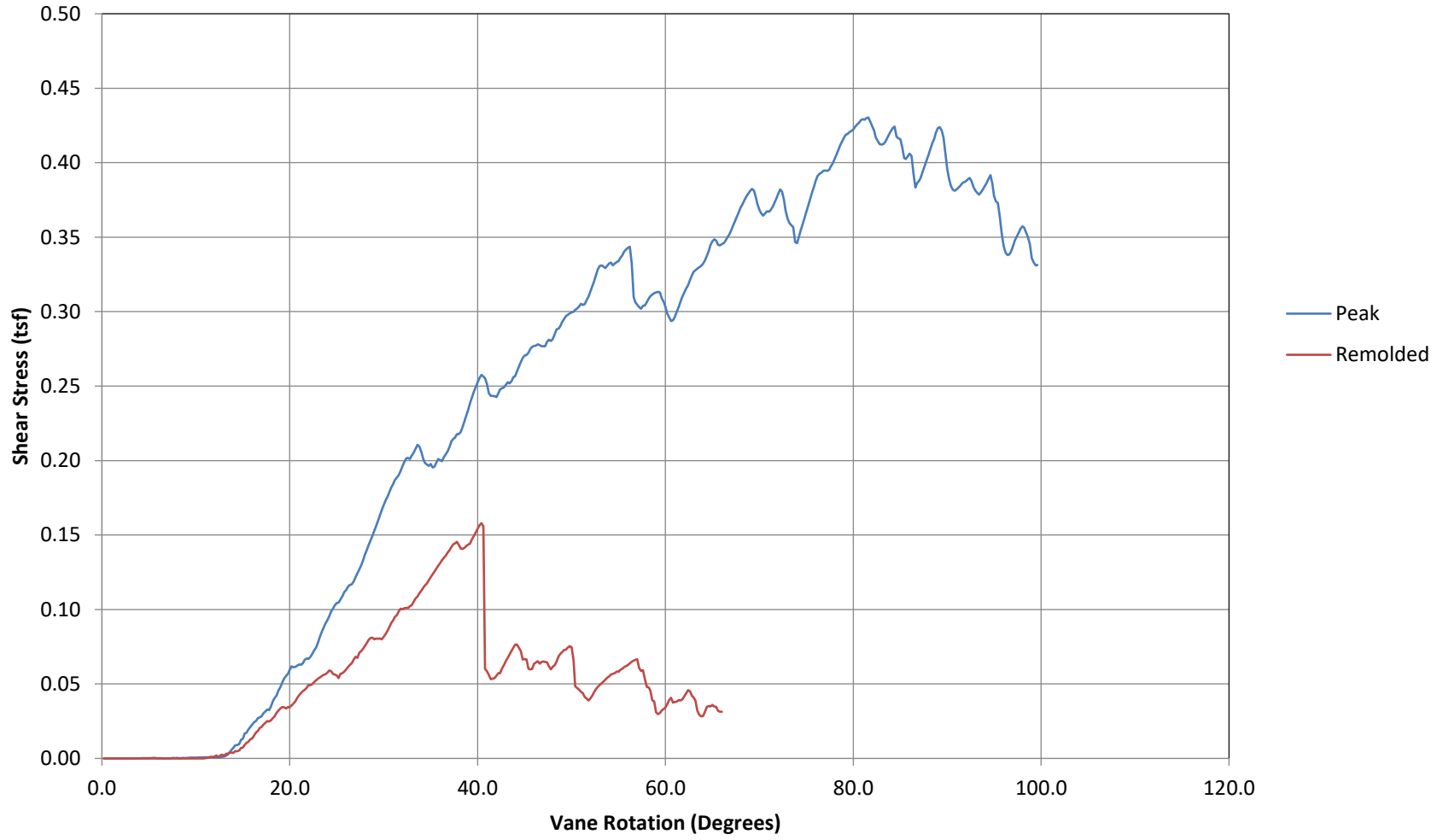


Job Number: 21-59-22445  
Client: Anchor QEA  
Project: LDW Phase 3  
Sounding: LDW21-GT20-GV

Test Date: 19-Jul-2021 12:16  
Test Depth (ft): 2.50  
Vane Type: Adara solid double tapered 75 x 150 mm (45°, 45°)

Coordinate System: WGS 84 Lat/Long  
Latitude: 0  
Longitude: 0

### Vane Shear Test



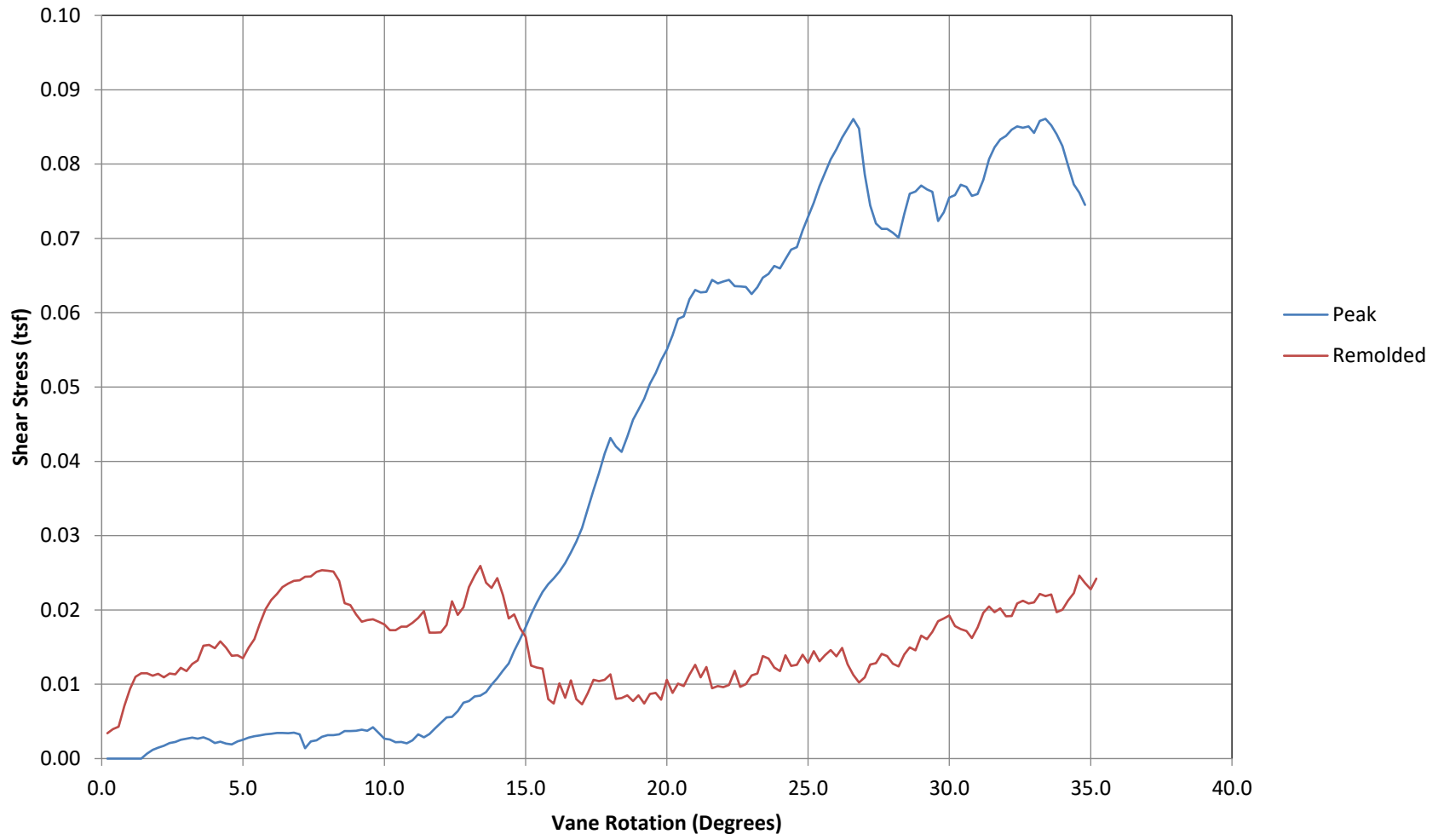


Job Number: 21-59-22445  
Client: Anchor QEA  
Project: LDW Phase 3  
Sounding: LDW21-GT20-GV

Test Date: 19-Jul-2021 12:50  
Test Depth (ft): 4.50  
Vane Type: Adara solid double tapered 75 x 150 mm (45°, 45°)

Coordinate System: WGS 84 Lat/Long  
Latitude: 0  
Longitude: 0

### Vane Shear Test



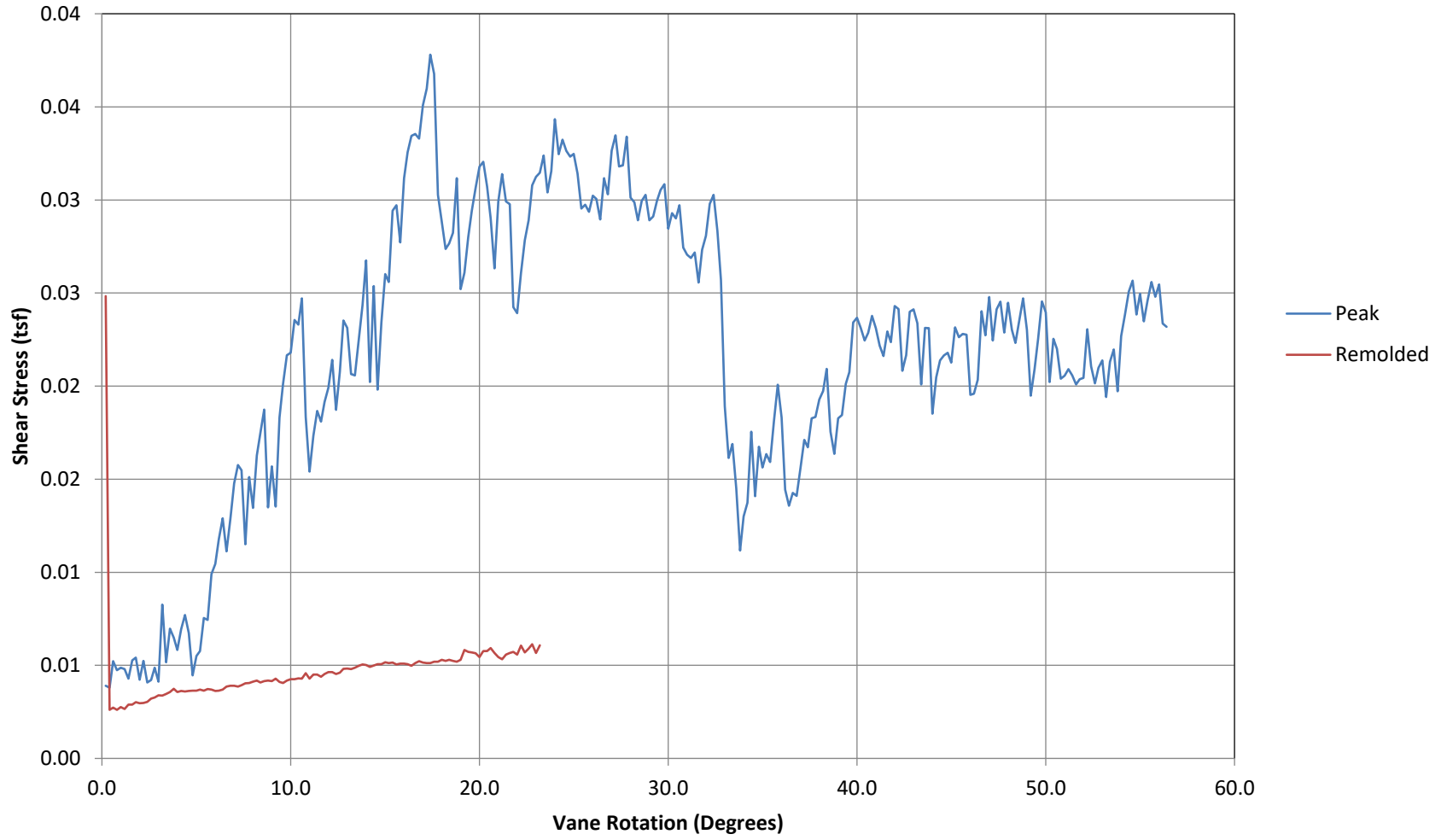


Job Number: 21-59-22445  
Client: Anchor QEA  
Project: LDW Phase 3  
Sounding: LDW21-GT-26-GV

Test Date: 07-Jul-2021 14:10  
Test Depth (ft): 1.17  
Vane Type: Adara solid double tapered 60 x 120 mm (45°, 45°)

Coordinate System: WGS 84 Lat/Long  
Latitude: 47.5215097  
Longitude: -122.3068371

### Vane Shear Test



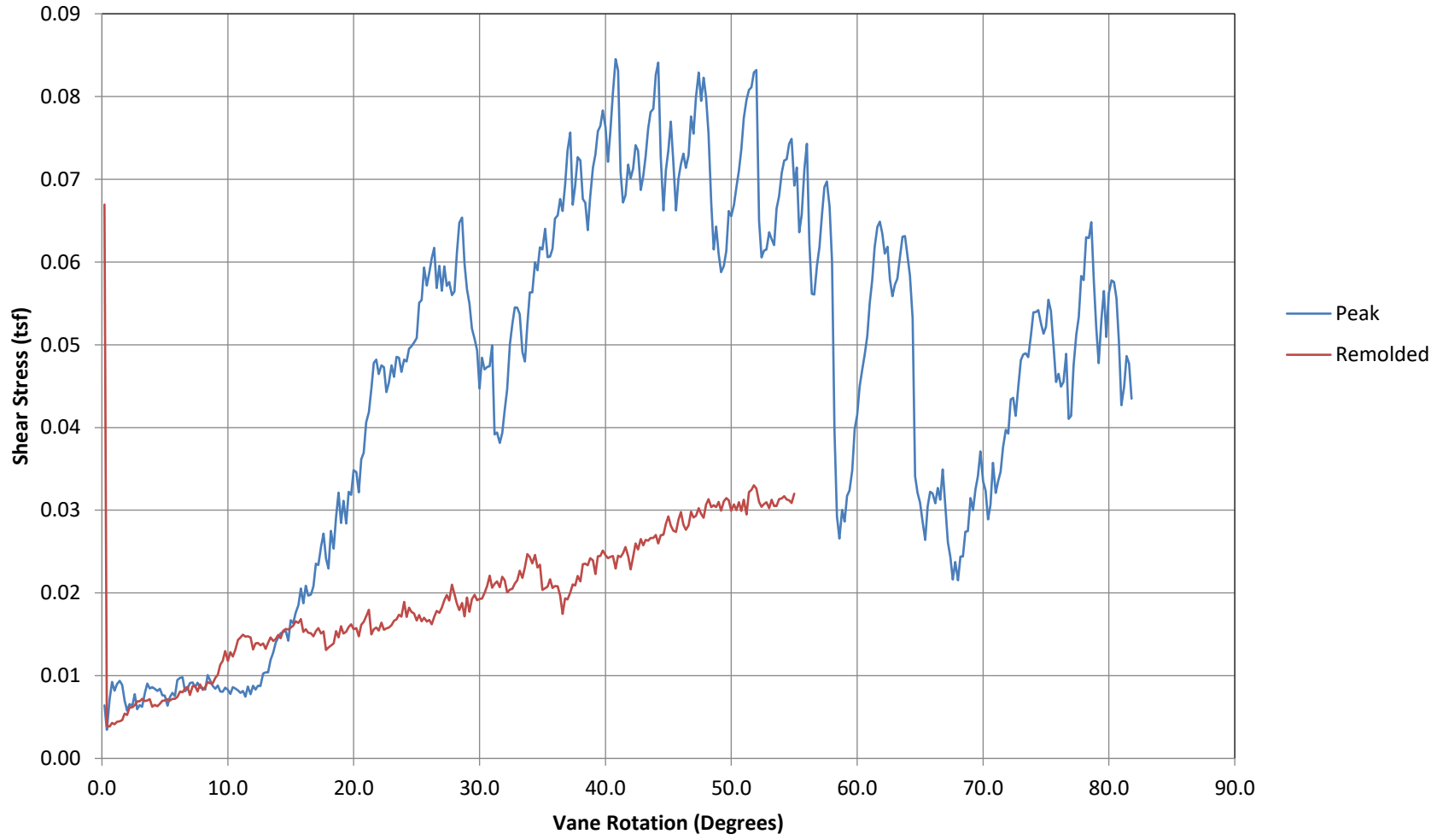


Job Number: 21-59-22445  
Client: Anchor QEA  
Project: LDW Phase 3  
Sounding: LDW21-GT-26-GV

Test Date: 07-Jul-2021 14:35  
Test Depth (ft): 3.17  
Vane Type: Adara solid double tapered 60 x 120 mm (45°, 45°)

Coordinate System: WGS 84 Lat/Long  
Latitude: 47.5215097  
Longitude: -122.3068371

### Vane Shear Test



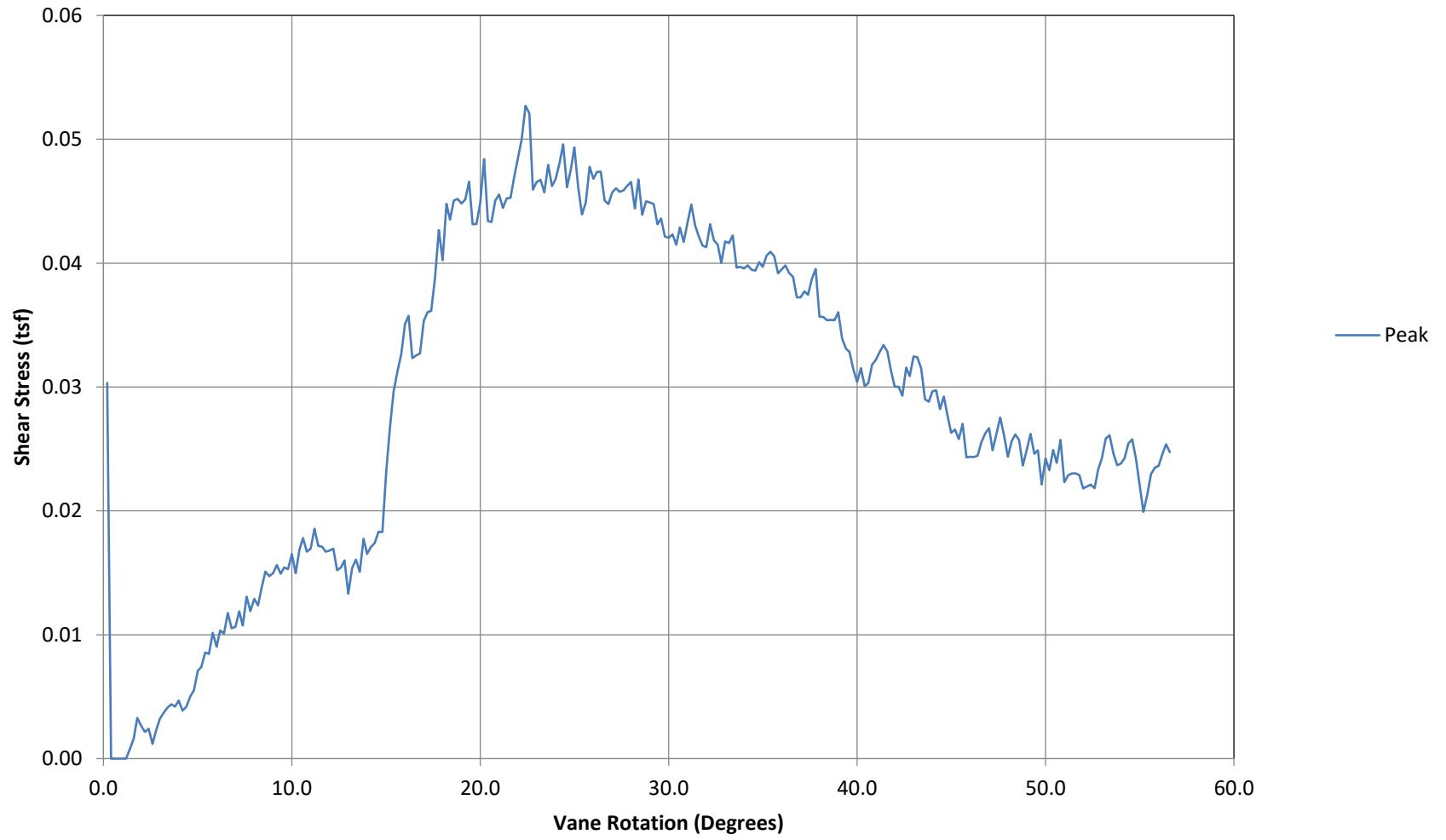


Job Number: 21-59-22445  
Client: Anchor QEA  
Project: LDW Phase 3  
Sounding: LDW21-GT-26-GV

Test Date: 07-Jul-2021 15:11  
Test Depth (ft): 4.42  
Vane Type: Adara solid double tapered 60 x 120 mm (45°, 45°)

Coordinate System: WGS 84 Lat/Long  
Latitude: 47.5215097  
Longitude: -122.3068371

### Vane Shear Test



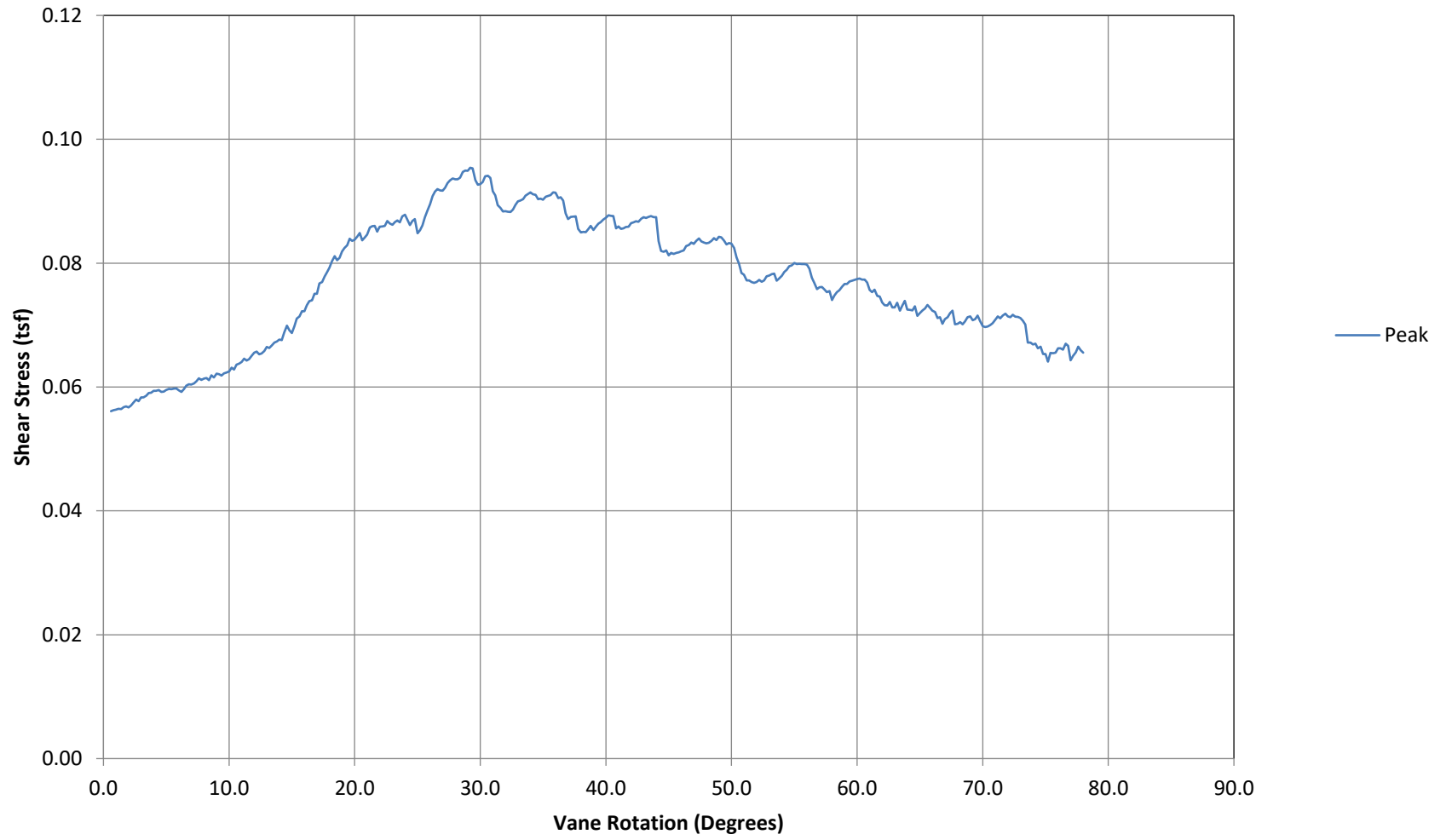


Job Number: 21-59-22445  
Client: Anchor QEA  
Project: LDW Phase 3  
Sounding: LDW21-GT-26-GV-B

Test Date: 07-Jul-2021 15:58  
Test Depth (ft): 1.17  
Vane Type: Adara solid double tapered 75 x 150 mm (45°, 45°)

Coordinate System: WGS 84 Lat/Long  
Latitude: 47.5215216  
Longitude: -122.3068046

### Vane Shear Test



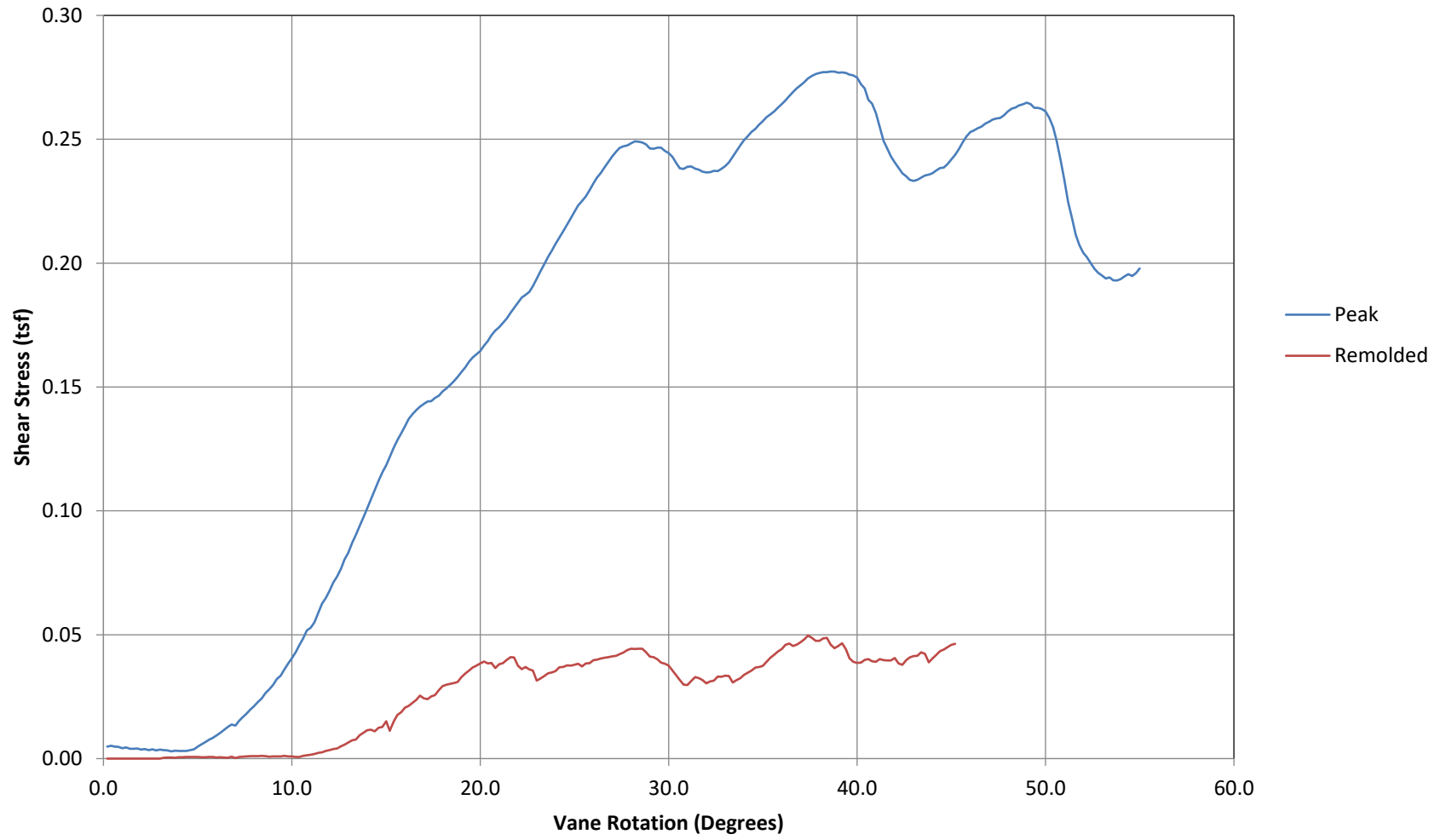


Job Number: 21-59-22445  
Client: Anchor QEA  
Project: LDW Phase 3  
Sounding: LDW21-GT43-GV

Test Date: 22-Jul-2021 16:10  
Test Depth (ft): 1.08  
Vane Type: Adara solid double tapered 75 x 150  
mm (45°, 45°)

Coordinate System: WGS 84 Lat/Long  
Latitude: 47.5111048  
Longitude: -122.3032936

### Vane Shear Test





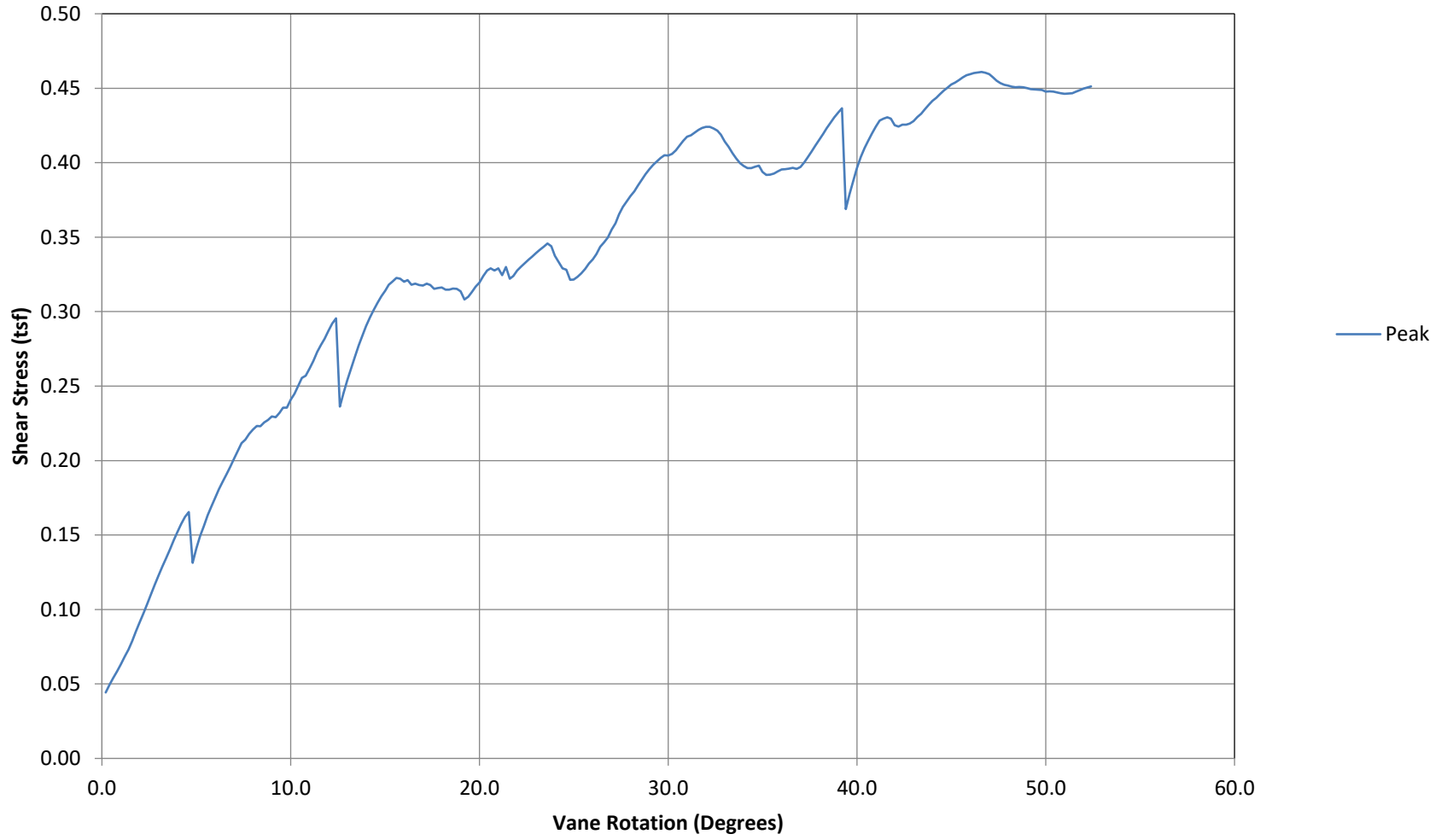


Job Number: 21-59-22445  
Client: Anchor QEA  
Project: LDW Phase 3  
Sounding: LDW21-GT43-GV

Test Date: 22-Jul-2021 16:36  
Test Depth (ft): 3.17  
Vane Type: Adara solid double tapered 75 x 150 mm (45°, 45°)

Coordinate System: WGS 84 Lat/Long  
Latitude: 47.5111048  
Longitude: -122.3032936

### Vane Shear Test





# Dynamic Cone Penetrometer

Exploration Log

180067-02.03  
 Lower Duwamish Waterway Upper Reach  
 South Park Marina

Location ID: LDW21-GT8-GD  
 Performed By: A. Barrett, G. Timm  
 Vert. Datum: NAD83  
 Horiz. Datum: WA St. Plane N.  
 Easting: 1275111.124  
 Northing: 195841.496

Surface Elevation: -2.8 MLLW  
 Groundwater Depth: NA  
 Hammer Weight: 35 lbs.  
 Cone Area: 10 sq. cm  
 Start Date 8/4/21  
 End Date 8/5/21

Depth	Blows per 10 cm	Resistance (kg/cm <sup>2</sup> )	Dynamic Cone Resistance (kg/cm <sup>2</sup> )				Correlated SPT N-Value	Density/Consistency	
			0	50	100	150		Cohesionless	Cohesive
-	0	0.0					0	V. Loose	V. Soft
-	0	0.0					0	V. Loose	V. Soft
- 1 ft	0	0.0					0	V. Loose	V. Soft
-	0	0.0					0	V. Loose	V. Soft
-	0	0.0					0	V. Loose	V. Soft
- 2 ft	0	0.0					0	V. Loose	V. Soft
-	0	0.0					0	V. Loose	V. Soft
-	0	0.0					0	V. Loose	V. Soft
- 3 ft	0	0.0					0	V. Loose	V. Soft
- 1 m	0	0.0					0	V. Loose	V. Soft
-	0	0.0					0	V. Loose	V. Soft
- 4 ft	0	0.0					0	V. Loose	V. Soft
-	0	0.0					0	V. Loose	V. Soft
-	0	0.0					0	V. Loose	V. Soft
- 5 ft	0	0.0					0	V. Loose	V. Soft
-	0	0.0					0	V. Loose	V. Soft
-	0	0.0					0	V. Loose	V. Soft
- 6 ft	0	0.0					0	V. Loose	V. Soft
-	0	0.0					0	V. Loose	V. Soft
- 2 m	0	0.0					0	V. Loose	V. Soft
-	0	0.0					0	V. Loose	V. Soft
- 7 ft	0	0.0					0	V. Loose	V. Soft
-	0	0.0					0	V. Loose	V. Soft
-	0	0.0					0	V. Loose	V. Soft
- 8 ft	0	0.0					0	V. Loose	V. Soft
-	0	0.0					0	V. Loose	V. Soft
-	0	0.0					0	V. Loose	V. Soft
- 9 ft	0	0.0					0	V. Loose	V. Soft
-	0	0.0					0	V. Loose	V. Soft
-	0	0.0					0	V. Loose	V. Soft
- 3 m 10 ft	0	0.0					0	V. Loose	V. Soft
-	0	0.0					0	V. Loose	V. Soft
-	0	0.0					0	V. Loose	V. Soft
-	0	0.0					0	V. Loose	V. Soft
- 11 ft	0	0.0					0	V. Loose	V. Soft
-	0	0.0					0	V. Loose	V. Soft
-	0	0.0					0	V. Loose	V. Soft
- 12 ft	0	0.0					0	V. Loose	V. Soft
-	0	0.0					0	V. Loose	V. Soft
-	0	0.0					0	V. Loose	V. Soft
- 4 m 13 ft	0	0.0					0	V. Loose	V. Soft



# Dynamic Cone Penetrometer

Exploration Log

180067-02.03  
 Lower Duwamish Waterway Upper Reach  
 South Park Marina

Location ID: LDW21-GT8-GD

Surface Elevation:

Performed By: A. Barrett, G. Timm

Groundwater Depth: NA

Depth	Blows per 10 cm	Resistance (kg/cm <sup>2</sup> )	Dynamic Cone Resistance (kg/cm <sup>2</sup> )				Correlated SPT N-Value	Density/Consistency	
			0	50	100	150		Cohesionless	Cohesive
-	0	0.0					0	V. Loose	V. Soft
-	0	0.0					0	V. Loose	V. Soft
- 14 ft	4	11.1	..				3	V. Loose	Soft
-	5	13.9	...				3	V. Loose	Soft
-	7	19.4	.....				5	Loose	M. Stiff
- 15 ft	13	36.0	.....				10	Loose	Stiff
-	24	66.5	.....				18	M. Dense	V. Stiff
-	41	113.6	.....				25+	Dense	Hard
- 16 ft	10	27.7	.....				7	Loose	M. Stiff
- 5 m	11	30.5	.....				8	Loose	M. Stiff
- 17 ft									
- 18 ft									
- 19 ft									
- 6 m									
- 20 ft									
- 21 ft									
- 22 ft									
- 7 m									
- 23 ft									
- 24 ft									
- 25 ft									
- 8 m									
- 26 ft									
- 27 ft									
- 28 ft									



# Dynamic Cone Penetrometer

Exploration Log

180067-02.03  
 Lower Duwamish Waterway Upper Reach  
 Boeing Development Center

Location ID: GT38-A  
 Performed By: A. Barrett, G. Timm  
 Vert. Datum: NAD83  
 Horiz. Datum: WA St. Plane N.  
 Easting: 1277389.19  
 Northing: 1906166.48

Surface Elevation: 0.0  
 Groundwater Depth: NA  
 Hammer Weight: 35 lbs.  
 Cone Area: 10 sq. cm  
 Start Date 8/4/21  
 End Date 8/5/21

Depth	Blows per 10 cm	Resistance (kg/cm <sup>2</sup> )	Dynamic Cone Resistance (kg/cm <sup>2</sup> )				Correlated SPT N-Value	Density/Consistency	
			0	50	100	150		Cohesionless	Cohesive
-	1	4.4	.				1	V. Loose	V. Soft
-	2	8.9	..				2	V. Loose	Soft
- 1 ft	3	13.3	...				3	V. Loose	Soft
-	4	17.8	....				5	Loose	M. Stiff
-	3	13.3	...				3	V. Loose	Soft
- 2 ft	2	8.9	..				2	V. Loose	Soft
-	1	4.4	.				1	V. Loose	V. Soft
-	4	17.8	....				5	Loose	M. Stiff
- 3 ft	4	17.8	....				5	Loose	M. Stiff
- 1 m	3	13.3	...				3	V. Loose	Soft
-	3	11.6	...				3	V. Loose	Soft
- 4 ft	2	7.7	..				2	V. Loose	Soft
-	3	11.6	...				3	V. Loose	Soft
-	3	11.6	...				3	V. Loose	Soft
- 5 ft	4	15.4	....				4	V. Loose	Soft
-	3	11.6	...				3	V. Loose	Soft
-	3	11.6	...				3	V. Loose	Soft
- 6 ft	3	11.6	...				3	V. Loose	Soft
-	5	19.3	.....				5	Loose	M. Stiff
- 2 m	7	27.0	.....				7	Loose	M. Stiff
- 7 ft									
- 8 ft									
- 9 ft									
- 3 m 10 ft									
- 11 ft									
- 12 ft									
- 4 m 13 ft									



# Dynamic Cone Penetrometer

Exploration Log

180067-02.03  
 Lower Duwamish Waterway Upper Reach  
 Boeing Development Center

Location ID: GT38-B  
 Performed By: A. Barrett, G. Timm  
 Vert. Datum: NAD83  
 Horiz. Datum: WA St. Plane N.  
 Easting: 1277392.36  
 Northing: 190614.83

Surface Elevation: 0.0  
 Groundwater Depth: NA  
 Hammer Weight: 35 lbs.  
 Cone Area: 10 sq. cm  
 Start Date 8/4/21  
 End Date 8/5/21

Depth	Blows per 10 cm	Resistance (kg/cm <sup>2</sup> )	Dynamic Cone Resistance (kg/cm <sup>2</sup> )				Correlated SPT N-Value	Density/Consistency	
			0	50	100	150		Cohesionless	Cohesive
-	3	13.3	...				3	V. Loose	Soft
-	2	8.9	..				2	V. Loose	Soft
- 1 ft	1	4.4	.				1	V. Loose	V. Soft
-	2	8.9	..				2	V. Loose	Soft
-	2	8.9	..				2	V. Loose	Soft
- 2 ft	3	13.3	...				3	V. Loose	Soft
-	2	8.9	..				2	V. Loose	Soft
-	1	4.4	.				1	V. Loose	V. Soft
- 3 ft	4	17.8	....				5	Loose	M. Stiff
- 1 m	4	17.8	....				5	Loose	M. Stiff
-	2	7.7	..				2	V. Loose	Soft
- 4 ft	3	11.6	...				3	V. Loose	Soft
-	3	11.6	...				3	V. Loose	Soft
-	3	11.6	...				3	V. Loose	Soft
- 5 ft	4	15.4	....				4	V. Loose	Soft
-	3	11.6	...				3	V. Loose	Soft
-	3	11.6	...				3	V. Loose	Soft
- 6 ft	3	11.6	...				3	V. Loose	Soft
-	7	27.0	.....				7	Loose	M. Stiff
- 2 m	4	15.4	....				4	V. Loose	Soft
- 7 ft	3	10.3	..				2	V. Loose	Soft
-	9	30.8	.....				8	Loose	M. Stiff
-	5	17.1	....				4	V. Loose	Soft
- 8 ft	8	27.4	.....				7	Loose	M. Stiff
-	7	23.9	.....				6	Loose	M. Stiff
-	14	47.9	.....				13	M. Dense	Stiff
- 9 ft	15	51.3	.....				14	M. Dense	Stiff
-	16	54.7	.....				15	M. Dense	Stiff
-	19	65.0	.....				18	M. Dense	V. Stiff
- 3 m 10 ft	19	65.0	.....				18	M. Dense	V. Stiff
-	19	58.1	.....				16	M. Dense	V. Stiff
-	20	61.2	.....				17	M. Dense	V. Stiff
-	21	64.3	.....				18	M. Dense	V. Stiff
- 11 ft	28	85.7	.....				24	M. Dense	V. Stiff
-	23	70.4	.....				20	M. Dense	V. Stiff
-	18	55.1	.....				15	M. Dense	Stiff
- 12 ft	18	55.1	.....				15	M. Dense	Stiff
-	18	55.1	.....				15	M. Dense	Stiff
-	17	52.0	.....				14	M. Dense	Stiff
- 4 m 13 ft	24	73.4	.....				20	M. Dense	V. Stiff



# Dynamic Cone Penetrometer

Exploration Log

180067-02.03  
 Lower Duwamish Waterway Upper Reach  
 Boeing Development Center

Location ID: GT38-B

Surface Elevation:

Performed By: A. Barrett, G. Timm

Groundwater Depth: NA

Depth	Blows per 10 cm	Resistance (kg/cm <sup>2</sup> )	Dynamic Cone Resistance (kg/cm <sup>2</sup> )				Correlated SPT N-Value	Density/Consistency	
			0	50	100	150		Cohesionless	Cohesive
-	29	80.3	.....				22	M. Dense	V. Stiff
-	25	69.3	.....				19	M. Dense	V. Stiff
- 14 ft	20	55.4	.....				15	M. Dense	Stiff
-	13	36.0	.....				10	Loose	Stiff
-	13	36.0	.....				10	Loose	Stiff
- 15 ft	10	27.7	.....				7	Loose	M. Stiff
-	8	22.2	.....				6	Loose	M. Stiff
-	5	13.9	...				3	V. Loose	Soft
- 16 ft	7	19.4	.....				5	Loose	M. Stiff
- 5 m	8	22.2	.....				6	Loose	M. Stiff
-									
- 17 ft									
-									
- 18 ft									
-									
- 19 ft									
- 6 m									
- 20 ft									
-									
- 21 ft									
-									
- 22 ft									
-									
- 7 m 23 ft									
-									
- 24 ft									
-									
- 25 ft									
-									
- 26 ft									
- 8 m									
- 27 ft									
-									
- 28 ft									

## Appendix G – Geotechnical Design Analysis

### Attachment G.2

### Geotechnical Laboratory Testing

---



July 19, 2022

Anchor QEA, LLC.  
1201 3<sup>rd</sup> Avenue, Suite 2600  
Seattle, WA 98101

To Whom It May Concern,

MTC approves and authorizes the release and publication of statements, conclusions, and extracts from or regarding our reports to Anchor QEA, LLC.

If you have any other questions, feel free to call us at (360) 755-1990, or email me at [alex.eifrig@mtc-inc.net](mailto:alex.eifrig@mtc-inc.net).

Thank you,

**MATERIALS TESTING & CONSULTING, INC.**

Alex Eifrig  
NW Region Laboratory Manager  
WABO Supervising Laboratory Technician





**Client:** Anchor QEA  
**Address:** 21328 2nd Drive SE  
Bothell, WA 98021  
**Attn:** Garrett Timm  
**Revised on:** \_\_\_\_\_

**Date:** September 23, 2021  
**Project:** Q.C. - Lower Duwamish Waterway  
**Project #:** 21B233  
**Sample #:** B21-1427 - 1446  
**Date sampled:** 7-7-21 & 7-8-21

As requested MTC, Inc. has performed the following test(s) on the sample referenced above. The testing was performed in accordance with current applicable AASHTO or ASTM standards as indicated below. The results obtained in our laboratory were as follows below or on the attached pages:

	Test(s) Performed:	Test Results		Test(s) Performed:	Test Results
X	Sieve Analysis	Please See Attached Reports		Sulfate Soundness	
	Proctor			Bulk Density & Voids	
	Sand Equivalent			WSDOT Degradation	
	Fracture Count			LA Abrasion	
X	Moisture Content	Please See Attached Report	X	Direct Shear	Please See Attached Reports
	Specific Gravity, Coarse		X	Specific Gravity, Soils	Please See Attached Reports
	Specific Gravity, Fine				
X	Hydrometer Analysis	Please See Attached Reports			
X	Atterberg Limits	Please See Attached Reports			

If you have any questions concerning the test results, the procedures used, or if we can be of any further assistance please call on us at the number below.

Respectfully Submitted,  
 Meghan Blodgett-Carrillo  
 WABO Supervising Laboratory Technician





## ASTM D4318 - Liquid Limit, Plastic Limit and Plasticity Index of Soils

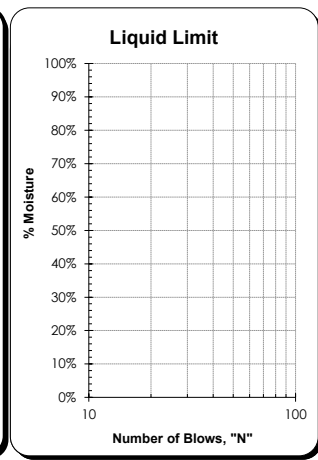
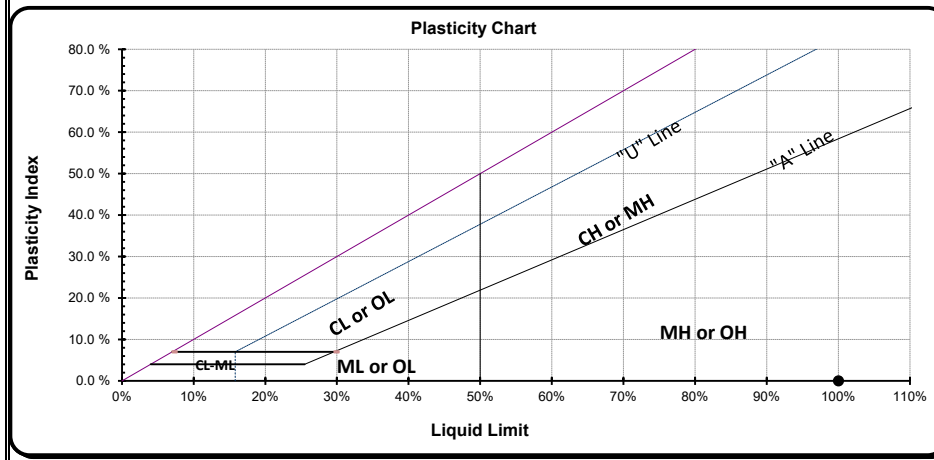
<b>Project:</b> Q.C. - Lower Duwamish Waterway <b>Project #:</b> 21B233 <b>Client:</b> Anchor QEA <b>Source:</b> LDW21-GT10-GB-0-9 ft <b>Sample #:</b> B21-1428	<b>Date Received:</b> 29-Jul-21 <b>Sampled By:</b> Client <b>Date Tested:</b> 23-Aug-21 <b>Tested By:</b> A. Eifrig	<b>Visual Identification</b> Silt with Clay <b>Sample Color</b> brown
---	--	--

Liquid Limit Determination						
	#1	#2	#3	#4	#5	#6
Weight of Wet Soils + Pan:	Liquid limit cannot be established					
Weight of Dry Soils + Pan:						
Weight of Pan:						
Weight of Dry Soils:						
Weight of Moisture:						
% Moisture:						
Number of Blows:						



**Liquid Limit @ 25 Blows:** N/A  
**Plastic Limit:** N/A  
**Plasticity Index, I<sub>p</sub>:** N/A

Plastic Limit Determination						
	#1	#2	#3	#4	#5	#6
Weight of Wet Soils + Pan:	Plastic limit cannot be determined					
Weight of Dry Soils + Pan:						
Weight of Pan:						
Weight of Dry Soils:						
Weight of Moisture:						
% Moisture:						



All results apply only to actual locations and materials tested. As a mutual protection to clients, the public and ourselves, all reports are submitted as the confidential property of clients, and authorization for publication of statements, conclusions or extracts from or regarding our reports is reserved pending our written approval.

**Comments:** Liquid limit cannot be established as the material displays rapid dilation upon spreading into the cup. At lower moistures the material does not spread into the liquid limit cup without tearing the soil cake. Plastic limit cannot be determined as the material does not roll down to 1/8" threads before cracking or crumbling. Non-plastic.

Reviewed by:   
 \_\_\_\_\_  
 Meghan Blodgett-Carrillo

## ASTM D4318 - Liquid Limit, Plastic Limit and Plasticity Index of Soils

<b>Project:</b> Q.C. - Lower Duwamish Waterway <b>Project #:</b> 21B233 <b>Client:</b> Anchor QEA <b>Source:</b> LDW21-GT10-GB-9-14 ft <b>Sample #:</b> B21-1429	<b>Date Received:</b> 29-Jul-21 <b>Sampled By:</b> Client <b>Date Tested:</b> 23-Aug-21 <b>Tested By:</b> A. Eifrig	<b>Visual Identification</b> Silt with Clay <b>Sample Color</b> brown
--	--	--

### Liquid Limit Determination

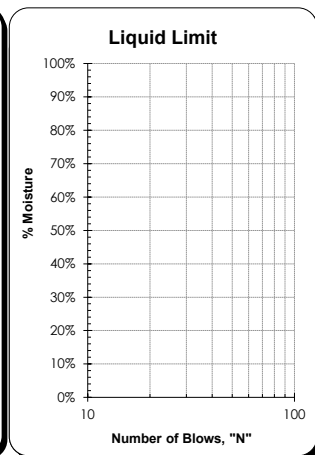
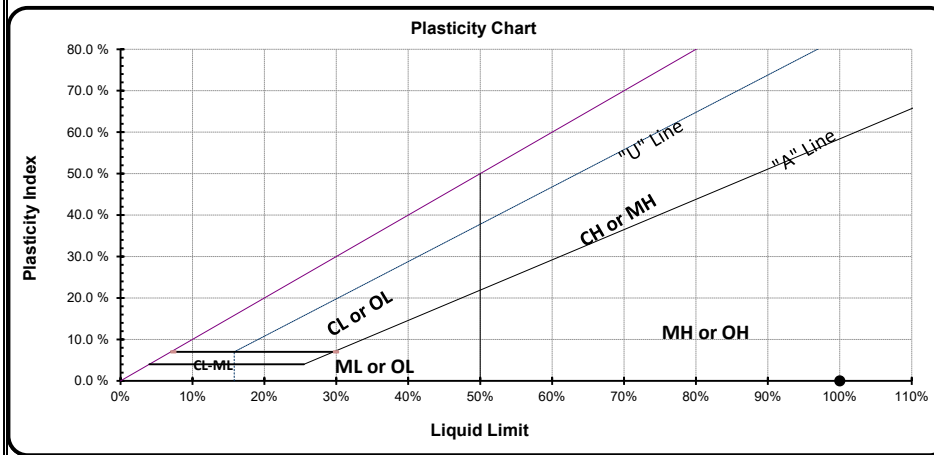
	#1	#2	#3	#4	#5	#6
<b>Weight of Wet Soils + Pan:</b>	40.29	42.71	29.23			
<b>Weight of Dry Soils + Pan:</b>	37.17	38.71	25.20			
<b>Weight of Pan:</b>	28.61	28.25	15.04			
<b>Weight of Dry Soils:</b>	8.56	10.46	10.16			
<b>Weight of Moisture:</b>	3.12	4.00	4.03			
<b>% Moisture:</b>	36.5 %	38.2 %	39.7 %			
<b>Number of Blows:</b>	27	16	11			



**Liquid Limit @ 25 Blows:** 37 %  
**Plastic Limit:** N/A  
**Plasticity Index, I<sub>p</sub>:** N/A

### Plastic Limit Determination

	#1	#2	#3	#4	#5	#6
<b>Weight of Wet Soils + Pan:</b>						
<b>Weight of Dry Soils + Pan:</b>	Plastic limit cannot be determined					
<b>Weight of Pan:</b>						
<b>Weight of Dry Soils:</b>						
<b>Weight of Moisture:</b>						
<b>% Moisture:</b>						



Copyright Spears Engineering & Technical Services PS, 1996-98

All results apply only to actual locations and materials tested. As a mutual protection to clients, the public and ourselves, all reports are submitted as the confidential property of clients, and authorization for publication of statements, conclusions or extracts from or regarding our reports is reserved pending our written approval.

**Comments:** Plastic limit cannot be determined as the material does not roll down to 1/8" threads before cracking or crumbling. Non-plastic.

Reviewed by:   
 Meghan Blodgett-Carrillo

# Sieve Report

<b>Project:</b> Q.C. - Lower Duwamish Waterway <b>Project #:</b> 21B233 <b>Client:</b> Anchor QEA <b>Source:</b> LDW21-GT10-GB-14-19 ft <b>Sample#:</b> B21-1430	<b>Date Received:</b> 29-Jul-21 <b>Sampled By:</b> Client <b>Date Tested:</b> 23-Aug-21 <b>Tested By:</b> A. Eifrig	<b>Visual Identification</b> Clayey Silt <b>Sample Color:</b> brown
--	--	--



**ASTM D2216, ASTM D2419, ASTM D4318, ASTM D5281**

**Specifications**

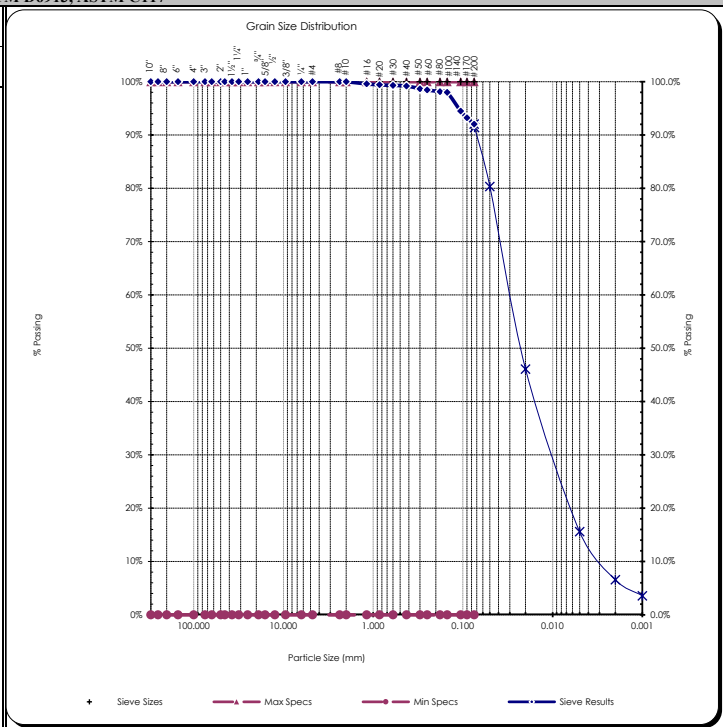
No Specs

Sample Meets Specs ? **N/A**

D <sub>(5)</sub> = 0.001 mm	% Gravel = 0.0%	Coeff. of Curvature, C <sub>c</sub> = 0.79
D <sub>(10)</sub> = 0.003 mm	% Sand = 8.0%	Coeff. of Uniformity, C <sub>u</sub> = 9.14
D <sub>(15)</sub> = 0.005 mm	% Silt & Clay = 92.0%	Fineness Modulus = 0.04
D <sub>(30)</sub> = 0.009 mm	Liquid Limit = n/a	Plastic Limit = n/a
D <sub>(50)</sub> = 0.024 mm	Plasticity Index = n/a	Moisture %, as sampled = 74.5%
D <sub>(60)</sub> = 0.031 mm	Sand Equivalent = n/a	Req'd Sand Equivalent =
D <sub>(90)</sub> = 0.072 mm	Fracture %, 1 Face = n/a	Req'd Fracture %, 1 Face =
Dust Ratio = 90/97	Fracture %, 2+ Faces = n/a	Req'd Fracture %, 2+ Faces =

**ASTM C136, ASTM D6913, ASTM C117**

Sieve Size		Actual Cumulative Percent Passing	Interpolated Cumulative Percent Passing	Specs Max	Specs Min
US	Metric				
12.00"	300.00		100%	100.0%	0.0%
10.00"	250.00		100%	100.0%	0.0%
8.00"	200.00		100%	100.0%	0.0%
6.00"	150.00		100%	100.0%	0.0%
4.00"	100.00		100%	100.0%	0.0%
3.00"	75.00		100%	100.0%	0.0%
2.50"	63.00		100%	100.0%	0.0%
2.00"	50.00		100%	100.0%	0.0%
1.75"	45.00		100%	100.0%	0.0%
1.50"	37.50		100%	100.0%	0.0%
1.25"	31.50		100%	100.0%	0.0%
1.00"	25.00		100%	100.0%	0.0%
3/4"	19.00		100%	100.0%	0.0%
5/8"	16.00		100%	100.0%	0.0%
1/2"	12.50		100%	100.0%	0.0%
3/8"	9.50	100%	100%	100.0%	0.0%
1/4"	6.30		100%	100.0%	0.0%
#4	4.75	100%	100%	100.0%	0.0%
#8	2.36		100%	100.0%	0.0%
#10	2.00	100%	100%	100.0%	0.0%
#16	1.18		100%	100.0%	0.0%
#20	0.850		99%	100.0%	0.0%
#30	0.600		99%	100.0%	0.0%
#40	0.425	99%	99%	100.0%	0.0%
#50	0.300		99%	100.0%	0.0%
#60	0.250		98%	100.0%	0.0%
#80	0.180		98%	100.0%	0.0%
#100	0.150	98%	98%	100.0%	0.0%
#140	0.106		95%	100.0%	0.0%
#170	0.090		93%	100.0%	0.0%
#200	0.075	92.0%	92.0%	100.0%	0.0%



Copyright Spears Engineering & Technical Services PS, 1996-98




All results apply only to actual locations and materials tested. As a mutual protection to clients, the public and ourselves, all reports are submitted as the confidential property of clients, and authorization for publication of statements, conclusions or extracts from or regarding our reports is reserved pending our written approval.

**Comments:**

Reviewed by:   
 Meghan Blodgett-Carrillo




## Hydrometer Report

<b>Project:</b> Q.C. - Lower Duwamish Waterway <b>Project #:</b> 21B233 <b>Client :</b> Anchor QEA <b>Source:</b> LDW21-GT10-GB-14-19 ft <b>Sample#:</b> B21-1430	<b>Date Received:</b> 29-Jul-21 <b>Sampled By:</b> Client <b>Date Tested:</b> 23-Aug-21 <b>Tested By:</b> A. Eifrig	<b>Visual Identification</b> Clayey Silt <b>Sample Color</b> brown																																																																																																																		
<b>ASTM D7928, HYDROMETER ANALYSIS</b>		<b>ASTM D6913</b>																																																																																																																		
<table style="width: 100%; border-collapse: collapse;"> <tr> <td style="width: 33%;"> <b>Assumed Sp Gr :</b> 2.65  <b>Sample Weight:</b> 50.30 grams  <b>Hydroscopic Moist.:</b> 3.78%  <b>Adj. Sample Wgt :</b> 48.47 grams           </td> <td style="width: 33%; text-align: center;">   <b>ACCREDITED</b>  <small>Certificate #: 1366.01</small> </td> <td style="width: 33%;"></td> </tr> </table> <table style="width: 100%; border-collapse: collapse;"> <thead> <tr> <th style="text-align: left;">Hydrometer Reading</th> <th style="text-align: left;">Corrected Reading</th> <th style="text-align: left;">Percent Passing</th> <th style="text-align: left;">Soils Particle Diameter</th> </tr> </thead> <tbody> <tr><td>1</td><td>35</td><td>72.2%</td><td>0.0444 mm</td></tr> <tr><td>2</td><td>30.5</td><td>62.9%</td><td>0.0326 mm</td></tr> <tr><td>4</td><td>24.5</td><td>50.5%</td><td>0.0240 mm</td></tr> <tr><td>15</td><td>18.5</td><td>38.2%</td><td>0.0129 mm</td></tr> <tr><td>30</td><td>15</td><td>30.9%</td><td>0.0093 mm</td></tr> <tr><td>60</td><td>10.5</td><td>21.7%</td><td>0.0068 mm</td></tr> <tr><td>240</td><td>5</td><td>10.3%</td><td>0.0035 mm</td></tr> <tr><td>1440</td><td>2.5</td><td>5.2%</td><td>0.0014 mm</td></tr> </tbody> </table> <table style="width: 100%; border-collapse: collapse;"> <tr> <td style="width: 33%;"> <b>% Gravel:</b> 0.0%  <b>% Sand:</b> 8.0%  <b>% Silt:</b> 76.4%  <b>% Clay:</b> 15.6%           </td> <td style="width: 33%; text-align: right;"> <b>Liquid Limit:</b> n/a  <b>Plastic Limit:</b> n/a  <b>Plasticity Index:</b> n/a           </td> <td style="width: 33%;"></td> </tr> </table>		<b>Assumed Sp Gr :</b> 2.65 <b>Sample Weight:</b> 50.30 grams <b>Hydroscopic Moist.:</b> 3.78% <b>Adj. Sample Wgt :</b> 48.47 grams	 <b>ACCREDITED</b> <small>Certificate #: 1366.01</small>		Hydrometer Reading	Corrected Reading	Percent Passing	Soils Particle Diameter	1	35	72.2%	0.0444 mm	2	30.5	62.9%	0.0326 mm	4	24.5	50.5%	0.0240 mm	15	18.5	38.2%	0.0129 mm	30	15	30.9%	0.0093 mm	60	10.5	21.7%	0.0068 mm	240	5	10.3%	0.0035 mm	1440	2.5	5.2%	0.0014 mm	<b>% Gravel:</b> 0.0% <b>% Sand:</b> 8.0% <b>% Silt:</b> 76.4% <b>% Clay:</b> 15.6%	<b>Liquid Limit:</b> n/a <b>Plastic Limit:</b> n/a <b>Plasticity Index:</b> n/a		<table style="width: 100%; border-collapse: collapse;"> <thead> <tr> <th colspan="3" style="text-align: center;">Sieve Analysis</th> </tr> <tr> <th style="text-align: left;">Sieve Size</th> <th style="text-align: left;">Percent Passing</th> <th style="text-align: left;">Soils Particle Diameter</th> </tr> </thead> <tbody> <tr><td>3.0"</td><td>100%</td><td>75.000 mm</td></tr> <tr><td>2.0"</td><td>100%</td><td>50.000 mm</td></tr> <tr><td>1.5"</td><td>100%</td><td>37.500 mm</td></tr> <tr><td>1.25"</td><td>100%</td><td>31.500 mm</td></tr> <tr><td>1.0"</td><td>100%</td><td>25.000 mm</td></tr> <tr><td>3/4"</td><td>100%</td><td>19.000 mm</td></tr> <tr><td>5/8"</td><td>100%</td><td>16.000 mm</td></tr> <tr><td>1/2"</td><td>100%</td><td>12.500 mm</td></tr> <tr><td>3/8"</td><td>100%</td><td>9.500 mm</td></tr> <tr><td>1/4"</td><td>100%</td><td>6.300 mm</td></tr> <tr><td>#4</td><td>100%</td><td>4.750 mm</td></tr> <tr><td>#10</td><td>100%</td><td>2.000 mm</td></tr> <tr><td>#20</td><td>99%</td><td>0.850 mm</td></tr> <tr><td>#40</td><td>99%</td><td>0.425 mm</td></tr> <tr><td>#100</td><td>98%</td><td>0.150 mm</td></tr> <tr><td>#200</td><td>92.0%</td><td>0.075 mm</td></tr> <tr><td><b>Silts</b></td><td>91.4%</td><td>0.074 mm</td></tr> <tr><td></td><td>80.4%</td><td>0.050 mm</td></tr> <tr><td></td><td>46.1%</td><td>0.020 mm</td></tr> <tr><td><b>Clays</b></td><td>15.6%</td><td>0.005 mm</td></tr> <tr><td></td><td>6.6%</td><td>0.002 mm</td></tr> <tr><td><b>Colloids</b></td><td>3.6%</td><td>0.001 mm</td></tr> </tbody> </table>	Sieve Analysis			Sieve Size	Percent Passing	Soils Particle Diameter	3.0"	100%	75.000 mm	2.0"	100%	50.000 mm	1.5"	100%	37.500 mm	1.25"	100%	31.500 mm	1.0"	100%	25.000 mm	3/4"	100%	19.000 mm	5/8"	100%	16.000 mm	1/2"	100%	12.500 mm	3/8"	100%	9.500 mm	1/4"	100%	6.300 mm	#4	100%	4.750 mm	#10	100%	2.000 mm	#20	99%	0.850 mm	#40	99%	0.425 mm	#100	98%	0.150 mm	#200	92.0%	0.075 mm	<b>Silts</b>	91.4%	0.074 mm		80.4%	0.050 mm		46.1%	0.020 mm	<b>Clays</b>	15.6%	0.005 mm		6.6%	0.002 mm	<b>Colloids</b>	3.6%	0.001 mm
<b>Assumed Sp Gr :</b> 2.65 <b>Sample Weight:</b> 50.30 grams <b>Hydroscopic Moist.:</b> 3.78% <b>Adj. Sample Wgt :</b> 48.47 grams	 <b>ACCREDITED</b> <small>Certificate #: 1366.01</small>																																																																																																																			
Hydrometer Reading	Corrected Reading	Percent Passing	Soils Particle Diameter																																																																																																																	
1	35	72.2%	0.0444 mm																																																																																																																	
2	30.5	62.9%	0.0326 mm																																																																																																																	
4	24.5	50.5%	0.0240 mm																																																																																																																	
15	18.5	38.2%	0.0129 mm																																																																																																																	
30	15	30.9%	0.0093 mm																																																																																																																	
60	10.5	21.7%	0.0068 mm																																																																																																																	
240	5	10.3%	0.0035 mm																																																																																																																	
1440	2.5	5.2%	0.0014 mm																																																																																																																	
<b>% Gravel:</b> 0.0% <b>% Sand:</b> 8.0% <b>% Silt:</b> 76.4% <b>% Clay:</b> 15.6%	<b>Liquid Limit:</b> n/a <b>Plastic Limit:</b> n/a <b>Plasticity Index:</b> n/a																																																																																																																			
Sieve Analysis																																																																																																																				
Sieve Size	Percent Passing	Soils Particle Diameter																																																																																																																		
3.0"	100%	75.000 mm																																																																																																																		
2.0"	100%	50.000 mm																																																																																																																		
1.5"	100%	37.500 mm																																																																																																																		
1.25"	100%	31.500 mm																																																																																																																		
1.0"	100%	25.000 mm																																																																																																																		
3/4"	100%	19.000 mm																																																																																																																		
5/8"	100%	16.000 mm																																																																																																																		
1/2"	100%	12.500 mm																																																																																																																		
3/8"	100%	9.500 mm																																																																																																																		
1/4"	100%	6.300 mm																																																																																																																		
#4	100%	4.750 mm																																																																																																																		
#10	100%	2.000 mm																																																																																																																		
#20	99%	0.850 mm																																																																																																																		
#40	99%	0.425 mm																																																																																																																		
#100	98%	0.150 mm																																																																																																																		
#200	92.0%	0.075 mm																																																																																																																		
<b>Silts</b>	91.4%	0.074 mm																																																																																																																		
	80.4%	0.050 mm																																																																																																																		
	46.1%	0.020 mm																																																																																																																		
<b>Clays</b>	15.6%	0.005 mm																																																																																																																		
	6.6%	0.002 mm																																																																																																																		
<b>Colloids</b>	3.6%	0.001 mm																																																																																																																		
<b>USDA Soil Textural Classification</b>																																																																																																																				
<table style="width: 100%; border-collapse: collapse;"> <tr> <td style="width: 33%;"></td> <td style="width: 33%; text-align: center;"><b>Particle Size</b></td> </tr> <tr> <td><b>% Sand:</b></td> <td style="text-align: center;">2.0 - 0.05 mm</td> </tr> <tr> <td><b>% Silt:</b></td> <td style="text-align: center;">0.05 - 0.002 mm</td> </tr> <tr> <td><b>% Clay:</b></td> <td style="text-align: center;">&lt; 0.002 mm</td> </tr> </table> <table style="width: 100%; border-collapse: collapse;"> <tr> <td style="text-align: center;"><b>USDA Soil Textural Classification</b></td> </tr> <tr> <td style="text-align: center;">Silt Loam</td> </tr> </table>		<b>Particle Size</b>	<b>% Sand:</b>	2.0 - 0.05 mm	<b>% Silt:</b>	0.05 - 0.002 mm	<b>% Clay:</b>	< 0.002 mm	<b>USDA Soil Textural Classification</b>	Silt Loam																																																																																																										
	<b>Particle Size</b>																																																																																																																			
<b>% Sand:</b>	2.0 - 0.05 mm																																																																																																																			
<b>% Silt:</b>	0.05 - 0.002 mm																																																																																																																			
<b>% Clay:</b>	< 0.002 mm																																																																																																																			
<b>USDA Soil Textural Classification</b>																																																																																																																				
Silt Loam																																																																																																																				

All results apply only to actual locations and materials tested. As a mutual protection to clients, the public and ourselves, all reports are submitted as the confidential property of clients, and authorization for publication of statements, conclusions or extracts from or regarding our reports is reserved pending our written approval.

**Comments:** \_\_\_\_\_  
 \_\_\_\_\_  
 \_\_\_\_\_

**Reviewed by:**   
 \_\_\_\_\_  
 Meghan Blodgett-Carrillo

# Direct Shear Test Results:

ASTM D-3080



Project: Q.C. - Lower Duwamish Waterway  
 Project Number: 21B233  
 Laboratory Sample ID: B21-1430  
 Sample Date: 7/7/2021  
 Test Date: 9/20/2021  
 Technician: M. Carrillo

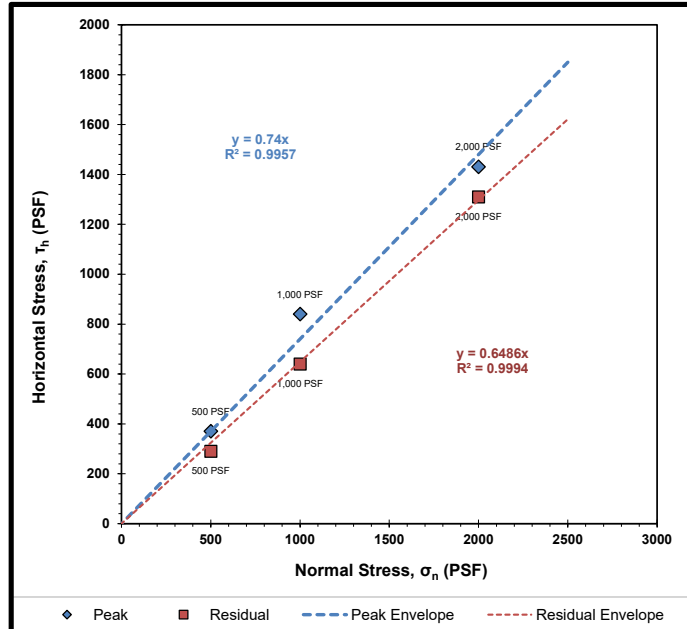
Sample Source: LDW21-GT10-GB-14-19 ft  
 Visual Soil Description: brown clayey silt  
 Type of Specimen: Remolded Cylindrical Shear Box  
 Specimen Diameter (in): 2.5  
 Specimen Height (in): 1  
 Rate of Strain (in/min): 0.0042  
 Estimated Specific Gravity of Solids: 2.65

Summary of Sample Data: $\sigma_n=500$ PSF		
Initial Moisture Content (%)	45.3	
	Initial	Post-Consolidation
Dry Density (PCF):	91.7	95.2
Void Ratio:	0.837	0.770
Porosity (%):	45.6	43.5
Degree of Saturation (%):	saturated	saturated

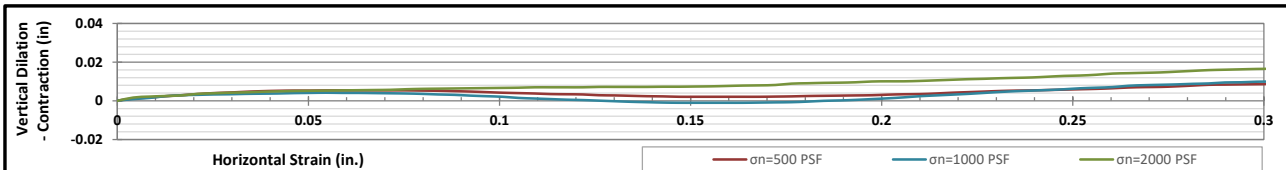
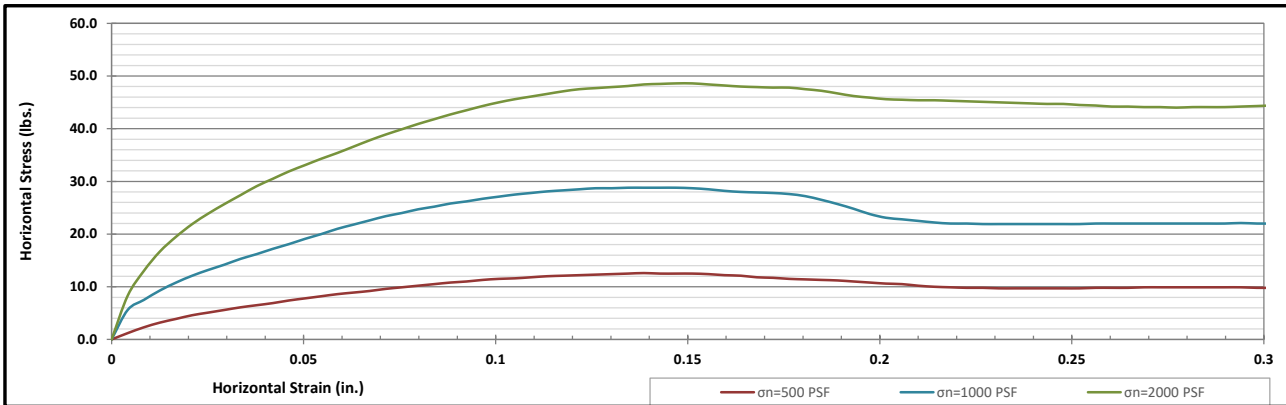
Summary of Sample Data: $\sigma_n=1000$ PSF		
Initial Moisture Content (%)	40.4	
	Initial	Post-Consolidation
Dry Density (PCF):	95.4	102.4
Void Ratio:	0.765	0.646
Porosity (%):	43.4	39.3
Degree of Saturation (%):	saturated	saturated

Summary of Sample Data: $\sigma_n=2000$ PSF		
Initial Moisture Content (%)	37.0	
	Initial	Post-Consolidation
Dry Density (PCF):	97.7	106.6
Void Ratio:	0.725	0.581
Porosity (%):	42.0	36.7
Degree of Saturation (%):	saturated	saturated

ESTIMATED STRENGTH PARAMETERS		
	PEAK	RESIDUAL
Angle of Internal Friction, $\phi$ (°):	37	33
Cohesion (PSF):	0	0



Failure Envelope Test Values:			
Normal Stress, $\sigma_n$ (PSF):	500	1000	2000
Peak Horizontal Stress, $\tau_h$ (PSF):	370	840	1430
Residual Horizontal Stress, $\tau_r$ (PSF):	290	640	1310



Corporate • 777 Chrysler Drive • Burlington, WA 98233 • Phone 360.755.1990 • Fax 360.755.1980  
 SW Region • 2118 Black Lake Blvd. S.W. • Olympia, WA 98512 • Phone 360.534.9777 • Fax 360.534.9779  
 NW Region • 805 Dupont, Suite #5 • Bellingham, WA 98225 • Phone 360.647.6061 • Fax 360.647.8111  
 Kitsap Region • 5451 N.W. Newberry Hill Road, Suite 101 • Silverdale, WA 98383 • Phone/Fax 360.698.6787

Visit our website: [www.mtc-inc.net](http://www.mtc-inc.net)

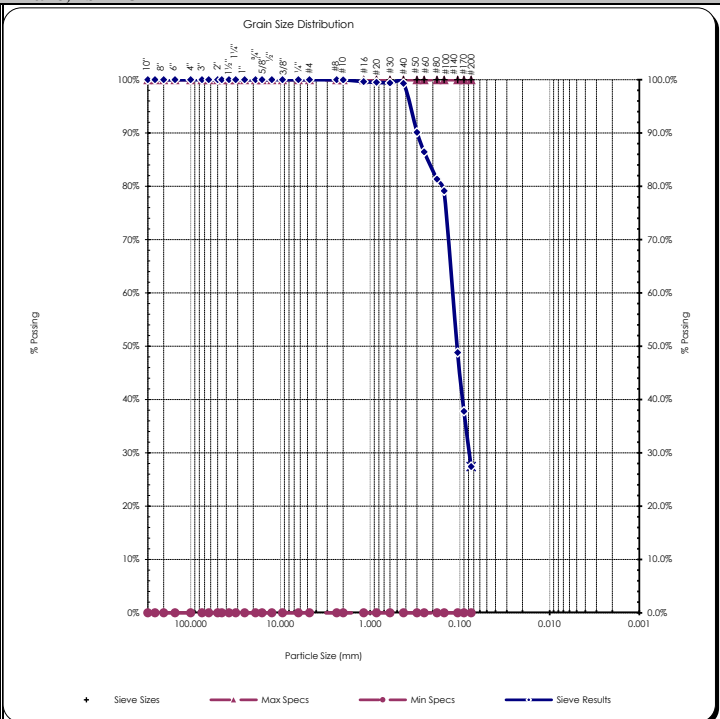


# Sieve Report

<b>Project:</b> Q.C. - Lower Duwamish Waterway <b>Project #:</b> 21B233 <b>Client:</b> Anchor QEA <b>Source:</b> LDW21-GT10-GB-19-24 ft <b>Sample#:</b> B21-1431	<b>Date Received:</b> 29-Jul-21 <b>Sampled By:</b> Client <b>Date Tested:</b> 23-Aug-21 <b>Tested By:</b> A. Eifrig	<b>Unified Soils Classification System, ASTM D-2487</b> SM, Silty Sand <b>Sample Color:</b> grayish-brown	 <b>ACCREDITED</b> Certificate #: 1366.01
--	--	--	---

<b>ASTM D2216, ASTM D2419, ASTM D4318, ASTM D5281</b>			
<b>Specifications</b> No Specs <b>Sample Meets Specs ?</b> N/A	D <sub>(5)</sub> = 0.014 mm D <sub>(10)</sub> = 0.027 mm D <sub>(15)</sub> = 0.041 mm D <sub>(30)</sub> = 0.079 mm D <sub>(50)</sub> = 0.108 mm D <sub>(60)</sub> = 0.122 mm D <sub>(90)</sub> = 0.298 mm Dust Ratio = 13/47	% Gravel = 0.0% % Sand = 72.5% % Silt & Clay = 27.5% Liquid Limit = n/a Plasticity Index = n/a Sand Equivalent = n/a Fracture %, 1 Face = n/a Fracture %, 2+ Faces = n/a	Coeff. of Curvature, C <sub>c</sub> = 1.85 Coeff. of Uniformity, C <sub>u</sub> = 4.47 Fineness Modulus = 0.32 Plastic Limit = n/a Moisture %, as sampled = 35.1% Req'd Sand Equivalent = Req'd Fracture %, 1 Face = Req'd Fracture %, 2+ Faces =

<b>ASTM C136, ASTM D6913, ASTM C117</b>					
<b>Sieve Size</b>		<b>Actual Cumulative Percent Passing</b>	<b>Interpolated Cumulative Percent Passing</b>	<b>Specs Max</b>	<b>Specs Min</b>
<b>US</b>	<b>Metric</b>				
12.00"	300.00		100%	100.0%	0.0%
10.00"	250.00		100%	100.0%	0.0%
8.00"	200.00		100%	100.0%	0.0%
6.00"	150.00		100%	100.0%	0.0%
4.00"	100.00		100%	100.0%	0.0%
3.00"	75.00		100%	100.0%	0.0%
2.50"	63.00		100%	100.0%	0.0%
2.00"	50.00		100%	100.0%	0.0%
1.75"	45.00		100%	100.0%	0.0%
1.50"	37.50		100%	100.0%	0.0%
1.25"	31.50		100%	100.0%	0.0%
1.00"	25.00	100%	100%	100.0%	0.0%
3/4"	19.00	100%	100%	100.0%	0.0%
5/8"	16.00		100%	100.0%	0.0%
1/2"	12.50	100%	100%	100.0%	0.0%
3/8"	9.50	100%	100%	100.0%	0.0%
1/4"	6.30		100%	100.0%	0.0%
#4	4.75	100%	100%	100.0%	0.0%
#8	2.36		100%	100.0%	0.0%
#10	2.00	100%	100%	100.0%	0.0%
#16	1.18	100%	100%	100.0%	0.0%
#20	0.850	99%	99%	100.0%	0.0%
#30	0.600		99%	100.0%	0.0%
#40	0.425	99%	99%	100.0%	0.0%
#50	0.300		90%	100.0%	0.0%
#60	0.250		86%	100.0%	0.0%
#80	0.180		81%	100.0%	0.0%
#100	0.150	79%	79%	100.0%	0.0%
#140	0.106		49%	100.0%	0.0%
#170	0.090		38%	100.0%	0.0%
#200	0.075	27.5%	27.5%	100.0%	0.0%



Copyright Spears Engineering & Technical Services PS, 1996-98  
 All results apply only to actual locations and materials tested. As a mutual protection to clients, the public and ourselves, all reports are submitted as the confidential property of clients, and authorization for publication of statements, conclusions or extracts from or regarding our reports is reserved pending our written approval.

**Comments:** \_\_\_\_\_

Reviewed by:   
 Meghan Blodgett-Carrillo

## ASTM D4318 - Liquid Limit, Plastic Limit and Plasticity Index of Soils

<b>Project:</b> Q.C. - Lower Duwamish Waterway <b>Project #:</b> 21B233 <b>Client:</b> Anchor QEA <b>Source:</b> LDW21-GT28-GB-0-10 ft <b>Sample #:</b> B21-1434	<b>Date Received:</b> 29-Jul-21 <b>Sampled By:</b> Client <b>Date Tested:</b> 25-Aug-21 <b>Tested By:</b> A. Eifrig	<b>Visual Identification</b> Clay with Silt <b>Sample Color</b> dark brown
--	--	---

### Liquid Limit Determination

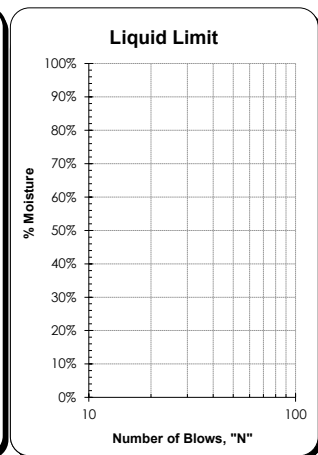
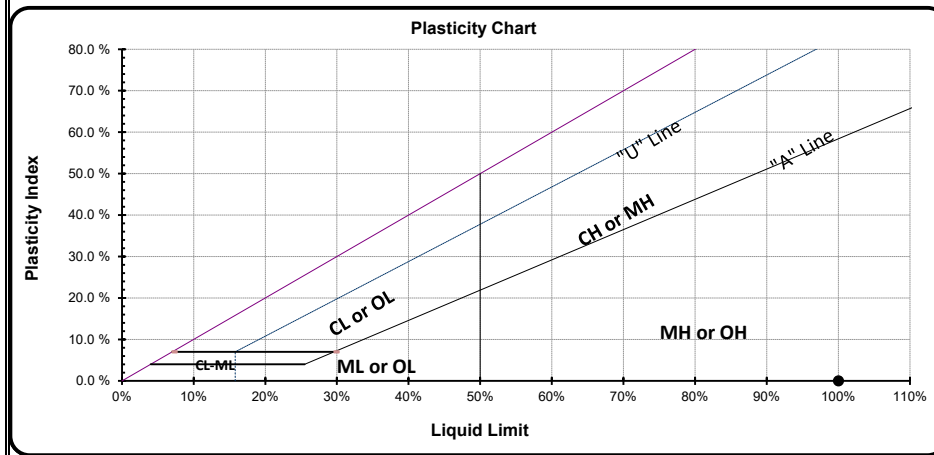
	#1	#2	#3	#4	#5	#6
Weight of Wet Soils + Pan:	33.52	24.84	28.54			
Weight of Dry Soils + Pan:	28.91	21.54	25.61			
Weight of Pan:	19.45	14.96	19.90			
Weight of Dry Soils:	9.46	6.58	5.71			
Weight of Moisture:	4.61	3.30	2.93			
% Moisture:	48.7 %	50.2 %	51.3 %			
Number of Blows:	34	22	19			



**Liquid Limit @ 25 Blows:** 50 %  
**Plastic Limit:** N/A  
**Plasticity Index, I<sub>p</sub>:** N/A

### Plastic Limit Determination

	#1	#2	#3	#4	#5	#6
Weight of Wet Soils + Pan:						
Weight of Dry Soils + Pan:	Plastic limit cannot be determined					
Weight of Pan:						
Weight of Dry Soils:						
Weight of Moisture:						
% Moisture:						



Copyright Spears Engineering & Technical Services PS, 1996-98

All results apply only to actual locations and materials tested. As a mutual protection to clients, the public and ourselves, all reports are submitted as the confidential property of clients, and authorization for publication of statements, conclusions or extracts from or regarding our reports is reserved pending our written approval.

**Comments:** Plastic Limit cannot be determined as the material does not roll down to 1/8" threads before cracking or crumbling. Non-plastic.

Reviewed by:   
 Meghan Blodgett-Carrillo

## ASTM D4318 - Liquid Limit, Plastic Limit and Plasticity Index of Soils

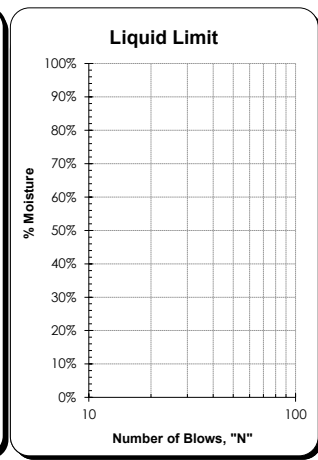
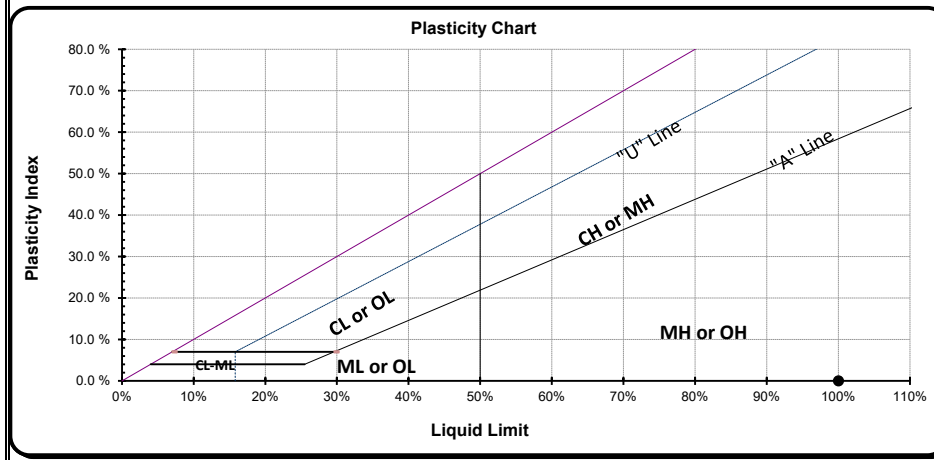
<b>Project:</b> Q.C. - Lower Duwamish Waterway <b>Project #:</b> 21B233 <b>Client:</b> Anchor QEA <b>Source:</b> LDW21-GT28-GB-10-15 ft <b>Sample #:</b> B21-1436	<b>Date Received:</b> 29-Jul-21 <b>Sampled By:</b> Client <b>Date Tested:</b> 25-Aug-21 <b>Tested By:</b> A. Eifrig	<b>Visual Identification</b> Silty Clay <b>Sample Color</b> dark brown
---	--	---

Liquid Limit Determination						
	#1	#2	#3	#4	#5	#6
Weight of Wet Soils + Pan:	30.19	31.68	32.21			
Weight of Dry Soils + Pan:	26.52	27.44	27.75			
Weight of Pan:	19.62	19.54	19.84			
Weight of Dry Soils:	6.90	7.90	7.91			
Weight of Moisture:	3.67	4.24	4.46			
% Moisture:	53.2 %	53.7 %	56.4 %			
Number of Blows:	25	21	12			



**Liquid Limit @ 25 Blows:** 53 %  
**Plastic Limit:** N/A  
**Plasticity Index, I<sub>p</sub>:** N/A

Plastic Limit Determination						
	#1	#2	#3	#4	#5	#6
Weight of Wet Soils + Pan:	Plastic limit cannot be determined					
Weight of Dry Soils + Pan:	Plastic limit cannot be determined					
Weight of Pan:	Plastic limit cannot be determined					
Weight of Dry Soils:	Plastic limit cannot be determined					
Weight of Moisture:	Plastic limit cannot be determined					
% Moisture:	Plastic limit cannot be determined					



Copyright Spears Engineering & Technical Services PS, 1996-98

All results apply only to actual locations and materials tested. As a mutual protection to clients, the public and ourselves, all reports are submitted as the confidential property of clients, and authorization for publication of statements, conclusions or extracts from or regarding our reports is reserved pending our written approval.

**Comments:** Plastic Limit cannot be determined as the material does not roll down to 1/8" threads before cracking or crumbling. Non-plastic.

Reviewed by:   
 \_\_\_\_\_  
 Meghan Blodgett-Carrillo

## ASTM D4318 - Liquid Limit, Plastic Limit and Plasticity Index of Soils

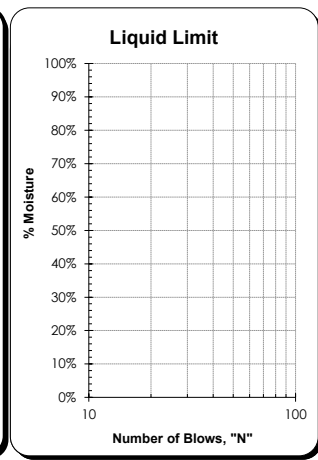
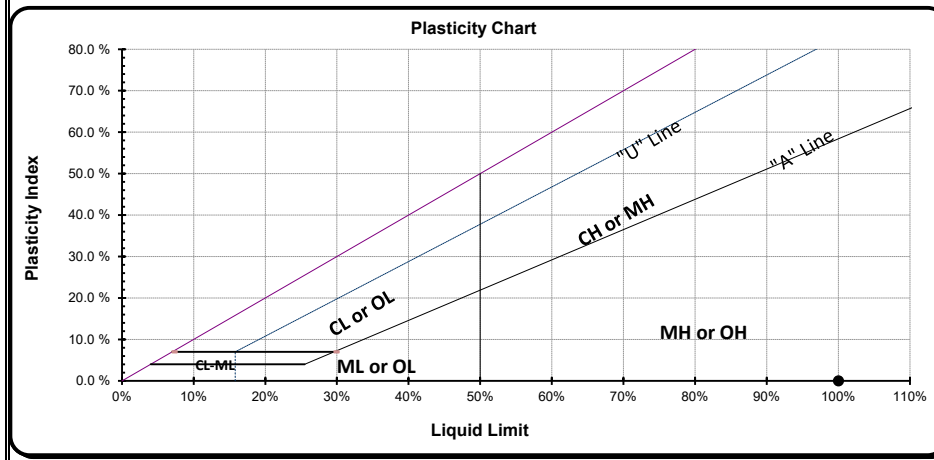
<b>Project:</b> Q.C. - Lower Duwamish Waterway <b>Project #:</b> 21B233 <b>Client:</b> Anchor QEA <b>Source:</b> LDW21-GT28-GB-15-16.8 ft <b>Sample #:</b> B21-1437	<b>Date Received:</b> 29-Jul-21 <b>Sampled By:</b> Client <b>Date Tested:</b> 25-Aug-21 <b>Tested By:</b> A. Eifrig	<b>Visual Identification</b> Clay and Silt <b>Sample Color</b> dark brown
---	--	--

Liquid Limit Determination						
	#1	#2	#3	#4	#5	#6
Weight of Wet Soils + Pan:	31.73	40.08	39.56			
Weight of Dry Soils + Pan:	28.13	36.32	36.04			
Weight of Pan:	19.86	28.17	28.53			
Weight of Dry Soils:	8.27	8.15	7.51			
Weight of Moisture:	3.60	3.76	3.52			
% Moisture:	43.5 %	46.1 %	46.9 %			
Number of Blows:	27	15	12			



**Liquid Limit @ 25 Blows:** 44 %  
**Plastic Limit:** N/A  
**Plasticity Index, I<sub>p</sub>:** N/A

Plastic Limit Determination						
	#1	#2	#3	#4	#5	#6
Weight of Wet Soils + Pan:						
Weight of Dry Soils + Pan:	Plastic limit cannot be determined					
Weight of Pan:						
Weight of Dry Soils:						
Weight of Moisture:						
% Moisture:						



Copyright Spears Engineering & Technical Services PS, 1996-98

All results apply only to actual locations and materials tested. As a mutual protection to clients, the public and ourselves, all reports are submitted as the confidential property of clients, and authorization for publication of statements, conclusions or extracts from or regarding our reports is reserved pending our written approval.

**Comments:** Plastic Limit cannot be determined as the material does not roll down to 1/8" threads before cracking or crumbling. Non-plastic.

Reviewed by:   
 \_\_\_\_\_  
 Meghan Blodgett-Carrillo

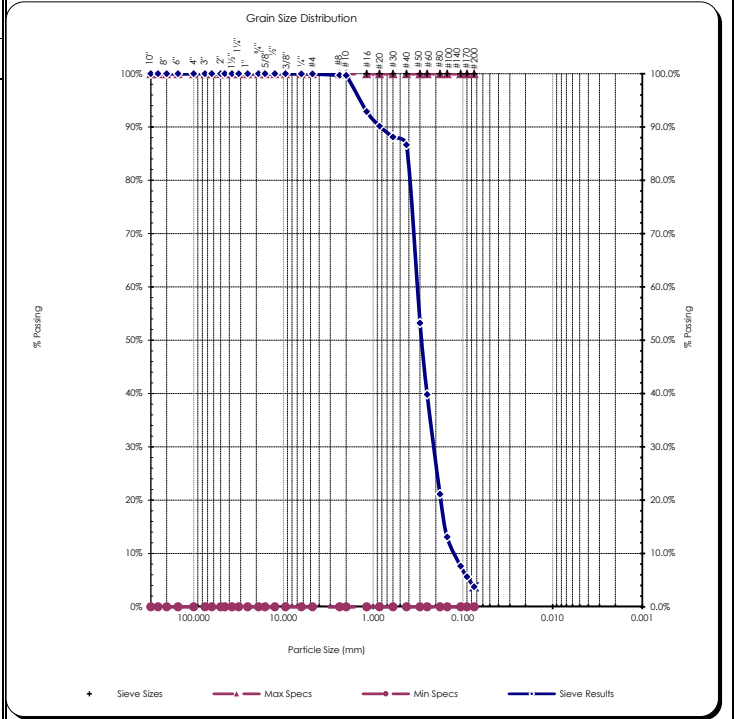
# Sieve Report

<b>Project:</b> Q.C. - Lower Duwamish Waterway <b>Project #:</b> 21B233 <b>Client:</b> Anchor QEA <b>Source:</b> LDW21-GT28-GB-16.8-20 ft <b>Sample#:</b> B21-1438	<b>Date Received:</b> 29-Jul-21 <b>Sampled By:</b> Client <b>Date Tested:</b> 23-Aug-21 <b>Tested By:</b> A. Eifrig	<b>Unified Soils Classification System, ASTM D-2487</b> SP, Poorly graded Sand <b>Sample Color:</b> gray	 <b>ACCREDITED</b> Certificate #: 1366.01
--	--	---	---

<b>ASTM D2216, ASTM D2419, ASTM D4318, ASTM D5281</b>			
<b>Specifications</b> No Specs <b>Sample Meets Specs ? N/A</b>	D <sub>(5)</sub> = 0.085 mm D <sub>(10)</sub> = 0.125 mm D <sub>(15)</sub> = 0.157 mm D <sub>(30)</sub> = 0.213 mm D <sub>(50)</sub> = 0.288 mm D <sub>(60)</sub> = 0.325 mm D <sub>(90)</sub> = 0.827 mm Dust Ratio = 1/23	% Gravel = 0.0% % Sand = 96.2% % Silt & Clay = 3.8% Liquid Limit = n/a Plasticity Index = n/a Sand Equivalent = n/a Fracture %, 1 Face = n/a Fracture %, 2+ Faces = n/a	Coeff. of Curvature, C <sub>c</sub> = 1.12 Coeff. of Uniformity, C <sub>u</sub> = 2.60 Fineness Modulus = 1.53 Plastic Limit = n/a Moisture %, as sampled = 29.7% Req'd Sand Equivalent = Req'd Fracture %, 1 Face = Req'd Fracture %, 2+ Faces =

**ASTM C136, ASTM D6913, ASTM C117**

Sieve Size		Actual Cumulative Percent Passing	Interpolated Cumulative Percent Passing	Specs Max	Specs Min
US	Metric				
12.00"	300.00		100%	100.0%	0.0%
10.00"	250.00		100%	100.0%	0.0%
8.00"	200.00		100%	100.0%	0.0%
6.00"	150.00		100%	100.0%	0.0%
4.00"	100.00		100%	100.0%	0.0%
3.00"	75.00		100%	100.0%	0.0%
2.50"	63.00		100%	100.0%	0.0%
2.00"	50.00		100%	100.0%	0.0%
1.75"	45.00		100%	100.0%	0.0%
1.50"	37.50		100%	100.0%	0.0%
1.25"	31.50		100%	100.0%	0.0%
1.00"	25.00	100%	100%	100.0%	0.0%
3/4"	19.00	100%	100%	100.0%	0.0%
5/8"	16.00		100%	100.0%	0.0%
1/2"	12.50	100%	100%	100.0%	0.0%
3/8"	9.50	100%	100%	100.0%	0.0%
1/4"	6.30		100%	100.0%	0.0%
#4	4.75	100%	100%	100.0%	0.0%
#8	2.36		100%	100.0%	0.0%
#10	2.00	100%	100%	100.0%	0.0%
#16	1.18		93%	100.0%	0.0%
#20	0.850		90%	100.0%	0.0%
#30	0.600		88%	100.0%	0.0%
#40	0.425	87%	87%	100.0%	0.0%
#50	0.300		53%	100.0%	0.0%
#60	0.250		40%	100.0%	0.0%
#80	0.180		21%	100.0%	0.0%
#100	0.150	13%	13%	100.0%	0.0%
#140	0.106		8%	100.0%	0.0%
#170	0.090		6%	100.0%	0.0%
#200	0.075	3.8%	3.8%	100.0%	0.0%



Copyright Spears Engineering & Technical Services PS, 1996-98

All results apply only to actual locations and materials tested. As a mutual protection to clients, the public and ourselves, all reports are submitted as the confidential property of clients, and authorization for publication of statements, conclusions or extracts from or regarding our reports is reserved pending our written approval.

**Comments:** \_\_\_\_\_

Reviewed by:   
 Meghan Blodgett-Carrillo

# Direct Shear Test Results:

ASTM D-3080



Project: Q.C. - Lower Duwamish Waterway  
 Project Number: 21B233  
 Laboratory Sample ID: B21-1438  
 Sample Date: 7/7/2021  
 Test Date: 8/25/2021  
 Technician: M. Carrillo

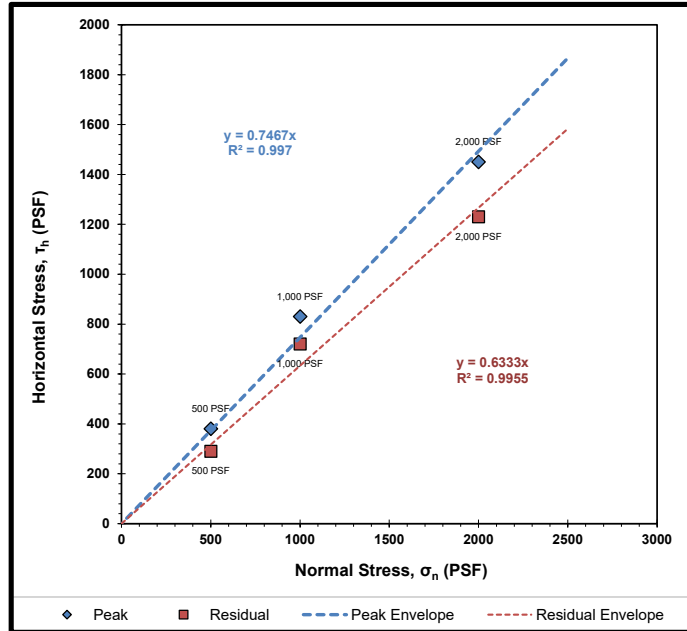
Sample Source: LDW21-GT28-GB-16.8-20 ft  
 Visual Soil Description: gray sand  
 Type of Specimen: Remolded Cylindrical Shear Box  
 Specimen Diameter (in): 2.5  
 Specimen Height (in): 1  
 Rate of Strain (in/min): 0.0208  
 Estimated Specific Gravity of Solids: 2.65

Summary of Sample Data: $\sigma_n=500$ PSF		
Initial Moisture Content (%)	31.3	
	Initial	Post-Consolidation
Dry Density (PCF):	105.4	106.7
Void Ratio:	0.598	0.579
Porosity (%):	37.4	36.7
Degree of Saturation (%):	saturated	saturated

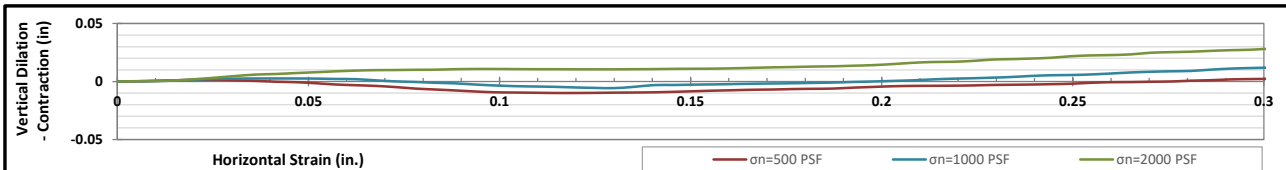
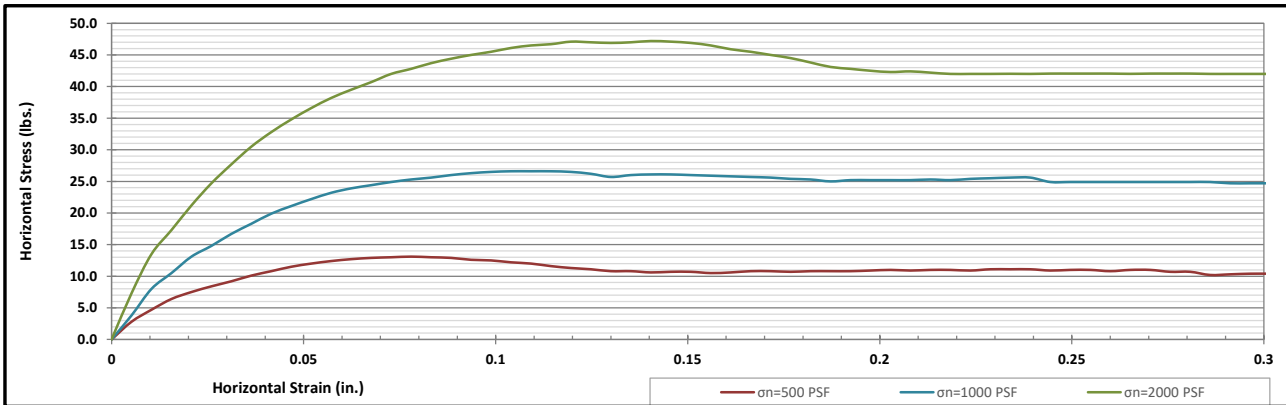
Summary of Sample Data: $\sigma_n=1000$ PSF		
Initial Moisture Content (%)	31.0	
	Initial	Post-Consolidation
Dry Density (PCF):	105.6	107.2
Void Ratio:	0.595	0.572
Porosity (%):	37.3	36.4
Degree of Saturation (%):	saturated	saturated

Summary of Sample Data: $\sigma_n=2000$ PSF		
Initial Moisture Content (%)	32.9	
	Initial	Post-Consolidation
Dry Density (PCF):	104.0	107.8
Void Ratio:	0.619	0.562
Porosity (%):	38.2	36.0
Degree of Saturation (%):	saturated	saturated

ESTIMATED STRENGTH PARAMETERS		
	PEAK	RESIDUAL
Angle of Internal Friction, $\phi$ (°):	37	32
Cohesion (PSF):	0	0



Failure Envelope Test Values:			
Normal Stress, $\sigma_n$ (PSF):	500	1000	2000
Peak Horizontal Stress, $\tau_h$ (PSF):	380	830	1450
Residual Horizontal Stress, $\tau_r$ (PSF):	290	720	1230



Corporate • 777 Chrysler Drive • Burlington, WA 98233 • Phone 360.755.1990 • Fax 360.755.1980  
 SW Region • 2118 Black Lake Blvd. S.W. • Olympia, WA 98512 • Phone 360.534.9777 • Fax 360.534.9779  
 NW Region • 805 Dupont, Suite #5 • Bellingham, WA 98225 • Phone 360.647.6061 • Fax 360.647.8111  
 Kitsap Region • 5451 N.W. Newberry Hill Road, Suite 101 • Silverdale, WA 98383 • Phone/Fax 360.698.6787

Visit our website: [www.mtc-inc.net](http://www.mtc-inc.net)

## ASTM D4318 - Liquid Limit, Plastic Limit and Plasticity Index of Soils

<b>Project:</b> Q.C. - Lower Duwamish Waterway <b>Project #:</b> 21B233 <b>Client:</b> Anchor QEA <b>Source:</b> LDW21-GT21-GB-0-13 ft <b>Sample #:</b> B21-1441	<b>Date Received:</b> 29-Jul-21 <b>Sampled By:</b> Client <b>Date Tested:</b> 25-Aug-21 <b>Tested By:</b> A. Eifrig	<b>Visual Identification</b> Silty Clay <b>Sample Color</b> dark brown
--	--	---

### Liquid Limit Determination

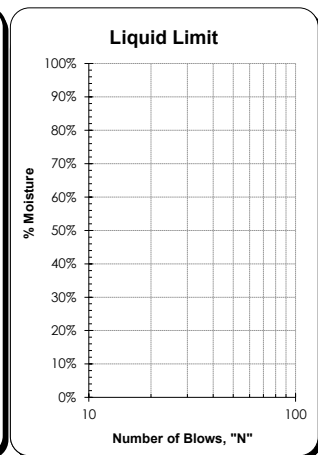
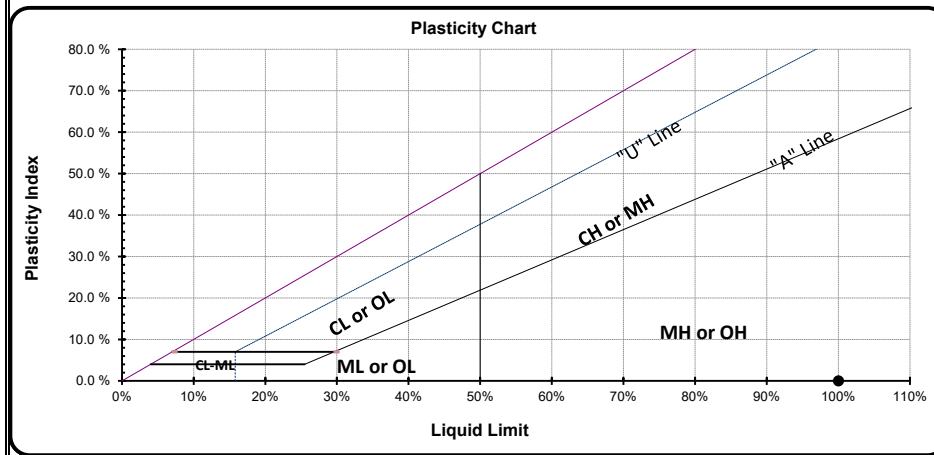
	#1	#2	#3	#4	#5	#6
Weight of Wet Soils + Pan:	28.39	31.98	25.34			
Weight of Dry Soils + Pan:	23.97	27.63	21.68			
Weight of Pan:	15.01	19.45	14.80			
Weight of Dry Soils:	8.96	8.18	6.88			
Weight of Moisture:	4.42	4.35	3.66			
% Moisture:	49.3 %	53.2 %	53.2 %			
Number of Blows:	35	17	19			



**Liquid Limit @ 25 Blows:** 52 %  
**Plastic Limit:** N/A  
**Plasticity Index, I<sub>p</sub>:** N/A

### Plastic Limit Determination

	#1	#2	#3	#4	#5	#6
Weight of Wet Soils + Pan:						
Weight of Dry Soils + Pan:	Plastic limit cannot be determined					
Weight of Pan:						
Weight of Dry Soils:						
Weight of Moisture:						
% Moisture:						



All results apply only to actual locations and materials tested. As a mutual protection to clients, the public and ourselves, all reports are submitted as the confidential property of clients, and authorization for publication of statements, conclusions or extracts from or regarding our reports is reserved pending our written approval.

**Comments:** Plastic Limit cannot be determined as the material does not roll down to 1/8" threads before cracking or crumbling. Non-plastic.

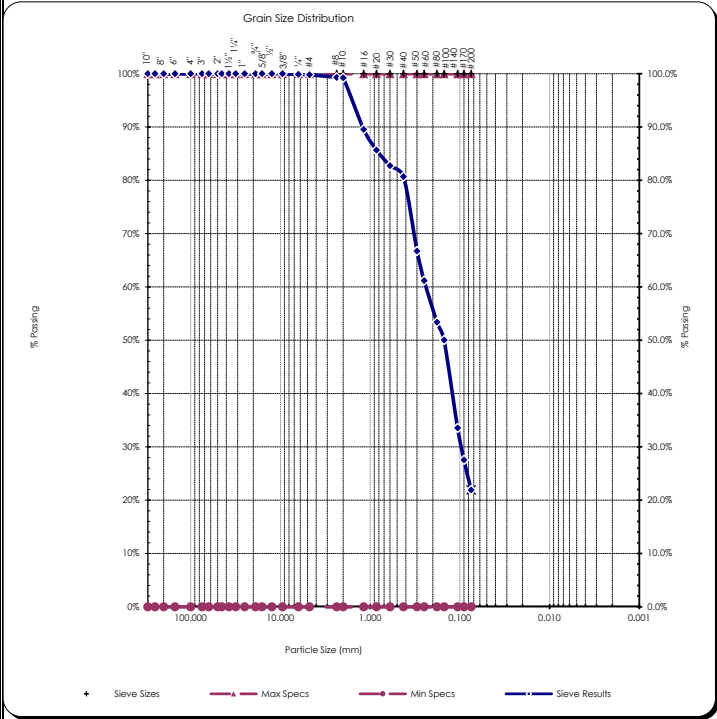
Reviewed by:   
 Meghan Blodgett-Carrillo

# Sieve Report

<b>Project:</b> Q.C. - Lower Duwamish Waterway <b>Project #:</b> 21B233 <b>Client:</b> Anchor QEA <b>Source:</b> LDW21-GT21-GB-13-16 ft <b>Sample#:</b> B21-1442	<b>Date Received:</b> 29-Jul-21 <b>Sampled By:</b> Client <b>Date Tested:</b> 23-Aug-21 <b>Tested By:</b> A. Eifrig	<b>Unified Soils Classification System, ASTM D-2487</b> SM, Silty Sand <b>Sample Color:</b> brown	 Certificate #: 1366.01
--	--	--	----------------------------

<b>ASTM D2216, ASTM D2419, ASTM D4318, ASTM D5281</b>			
<b>Specifications</b> No Specs <b>Sample Meets Specs ?</b> N/A	D <sub>(5)</sub> = 0.017 mm D <sub>(10)</sub> = 0.034 mm D <sub>(15)</sub> = 0.051 mm D <sub>(30)</sub> = 0.096 mm D <sub>(50)</sub> = 0.150 mm D <sub>(60)</sub> = 0.239 mm D <sub>(90)</sub> = 1.216 mm Dust Ratio = 3/11	% Gravel = 0.2% % Sand = 77.9% % Silt & Clay = 22.0% Liquid Limit = n/a Plasticity Index = n/a Sand Equivalent = n/a Fracture %, 1 Face = n/a Fracture %, 2+ Faces = n/a	Coeff. of Curvature, C <sub>c</sub> = 1.14 Coeff. of Uniformity, C <sub>u</sub> = 7.00 Fineness Modulus = 1.12 Plastic Limit = n/a Moisture %, as sampled = 96.5% Req'd Sand Equivalent = Req'd Fracture %, 1 Face = Req'd Fracture %, 2+ Faces =

<b>ASTM C136, ASTM D6913, ASTM C117</b>					
<b>Sieve Size</b>		<b>Actual Cumulative Percent Passing</b>	<b>Interpolated Cumulative Percent Passing</b>	<b>Specs Max</b>	<b>Specs Min</b>
<b>US</b>	<b>Metric</b>				
12.00"	300.00		100%	100.0%	0.0%
10.00"	250.00		100%	100.0%	0.0%
8.00"	200.00		100%	100.0%	0.0%
6.00"	150.00		100%	100.0%	0.0%
4.00"	100.00		100%	100.0%	0.0%
3.00"	75.00		100%	100.0%	0.0%
2.50"	63.00		100%	100.0%	0.0%
2.00"	50.00		100%	100.0%	0.0%
1.75"	45.00		100%	100.0%	0.0%
1.50"	37.50		100%	100.0%	0.0%
1.25"	31.50		100%	100.0%	0.0%
1.00"	25.00	100%	100%	100.0%	0.0%
3/4"	19.00	100%	100%	100.0%	0.0%
5/8"	16.00	100%	100%	100.0%	0.0%
1/2"	12.50	100%	100%	100.0%	0.0%
3/8"	9.50	100%	100%	100.0%	0.0%
1/4"	6.30	100%	100%	100.0%	0.0%
#4	4.75	100%	100%	100.0%	0.0%
#8	2.36		99%	100.0%	0.0%
#10	2.00	99%	99%	100.0%	0.0%
#16	1.18		90%	100.0%	0.0%
#20	0.850		86%	100.0%	0.0%
#30	0.600		83%	100.0%	0.0%
#40	0.425	81%	81%	100.0%	0.0%
#50	0.300		67%	100.0%	0.0%
#60	0.250		61%	100.0%	0.0%
#80	0.180		53%	100.0%	0.0%
#100	0.150	50%	50%	100.0%	0.0%
#140	0.106		34%	100.0%	0.0%
#170	0.090		28%	100.0%	0.0%
#200	0.075	22.0%	22.0%	100.0%	0.0%



Copyright Spears Engineering & Technical Services PS, 1996-98  
 All results apply only to actual locations and materials tested. As a mutual protection to clients, the public and ourselves, all reports are submitted as the confidential property of clients, and authorization for publication of statements, conclusions or extracts from or regarding our reports is reserved pending our written approval.

**Comments:** \_\_\_\_\_

Reviewed by:   
 Meghan Blodgett-Carrillo

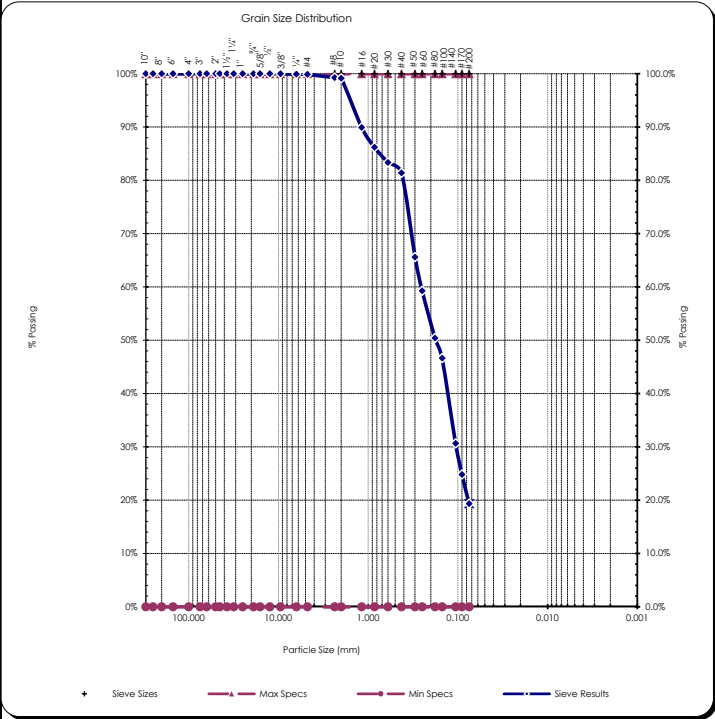


# Sieve Report

<b>Project:</b> Q.C. - Lower Duwamish Waterway <b>Project #:</b> 21B233 <b>Client:</b> Anchor QEA <b>Source:</b> LDW21-GT21-GB-16-21 ft <b>Sample#:</b> B21-1444	<b>Date Received:</b> 29-Jul-21 <b>Sampled By:</b> Client <b>Date Tested:</b> 23-Aug-21 <b>Tested By:</b> A. Eifrig	<b>Unified Soils Classification System, ASTM D-2487</b> SM, Silty Sand <b>Sample Color:</b> dark gray	 <b>ACCREDITED</b> Certificate #: 1366.01
--	--	--	---

<b>ASTM D2216, ASTM D2419, ASTM D4318, ASTM D5281</b>			
<b>Specifications</b> No Specs <b>Sample Meets Specs ?</b> N/A	D <sub>(5)</sub> = 0.019 mm D <sub>(10)</sub> = 0.039 mm D <sub>(15)</sub> = 0.058 mm D <sub>(30)</sub> = 0.104 mm D <sub>(50)</sub> = 0.177 mm D <sub>(60)</sub> = 0.256 mm D <sub>(90)</sub> = 1.188 mm Dust Ratio = 5/21	% Gravel = 0.1% % Sand = 80.5% % Silt & Clay = 19.4% Liquid Limit = n/a Plasticity Index = n/a Sand Equivalent = n/a Fracture %, 1 Face = n/a Fracture %, 2+ Faces = n/a	Coeff. of Curvature, C <sub>c</sub> = 1.10 Coeff. of Uniformity, C <sub>u</sub> = 6.61 Fineness Modulus = 1.15 Plastic Limit = n/a Moisture %, as sampled = 38.7% Req'd Sand Equivalent = Req'd Fracture %, 1 Face = Req'd Fracture %, 2+ Faces =

<b>ASTM C136, ASTM D6913, ASTM C117</b>					
Sieve Size		Actual Cumulative Percent Passing	Interpolated Cumulative Percent Passing	Specs Max	Specs Min
US	Metric				
12.00"	300.00		100%	100.0%	0.0%
10.00"	250.00		100%	100.0%	0.0%
8.00"	200.00		100%	100.0%	0.0%
6.00"	150.00		100%	100.0%	0.0%
4.00"	100.00		100%	100.0%	0.0%
3.00"	75.00		100%	100.0%	0.0%
2.50"	63.00		100%	100.0%	0.0%
2.00"	50.00		100%	100.0%	0.0%
1.75"	45.00		100%	100.0%	0.0%
1.50"	37.50		100%	100.0%	0.0%
1.25"	31.50		100%	100.0%	0.0%
1.00"	25.00	100%	100%	100.0%	0.0%
3/4"	19.00	100%	100%	100.0%	0.0%
5/8"	16.00	100%	100%	100.0%	0.0%
1/2"	12.50	100%	100%	100.0%	0.0%
3/8"	9.50	100%	100%	100.0%	0.0%
1/4"	6.30	100%	100%	100.0%	0.0%
#4	4.75	100%	100%	100.0%	0.0%
#8	2.36		99%	100.0%	0.0%
#10	2.00	99%	99%	100.0%	0.0%
#16	1.18		90%	100.0%	0.0%
#20	0.850		86%	100.0%	0.0%
#30	0.600		83%	100.0%	0.0%
#40	0.425	81%	81%	100.0%	0.0%
#50	0.300		66%	100.0%	0.0%
#60	0.250		59%	100.0%	0.0%
#80	0.180		50%	100.0%	0.0%
#100	0.150	47%	47%	100.0%	0.0%
#140	0.106		31%	100.0%	0.0%
#170	0.090		25%	100.0%	0.0%
#200	0.075	19.4%	19.4%	100.0%	0.0%



Copyright Spears Engineering & Technical Services PS, 1996-98  
 All results apply only to actual locations and materials tested. As a mutual protection to clients, the public and ourselves, all reports are submitted as the confidential property of clients, and authorization for publication of statements, conclusions or extracts from or regarding our reports is reserved pending our written approval.

**Comments:** \_\_\_\_\_

**Reviewed by:**   
 \_\_\_\_\_  
 Meghan Blodgett-Carrillo

# Direct Shear Test Results:

ASTM D-3080



Project: Q.C. - Lower Duwamish Waterway  
 Project Number: 21B233  
 Laboratory Sample ID: B21-1444  
 Sample Date: 7/8/2021  
 Test Date: 9/13/2021  
 Technician: M. Carrillo

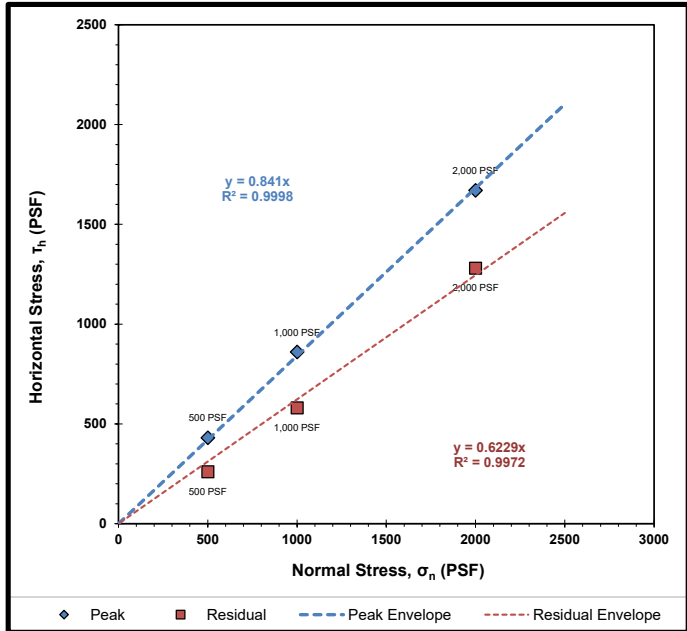
Sample Source: LDW21-GT21-GB-16-21 ft  
 Visual Soil Description: dark gray sand  
 Type of Specimen: Remolded Cylindrical Shear Box  
 Specimen Diameter (in): 2.5  
 Specimen Height (in): 1  
 Rate of Strain (in/min): 0.0208  
 Estimated Specific Gravity of Solids: 2.65

Summary of Sample Data: $\sigma_n=500$ PSF		
Initial Moisture Content (%)	26.8	
	Initial	Post-Consolidation
Dry Density (PCF):	107.5	109.1
Void Ratio:	0.568	0.545
Porosity (%):	36.2	35.3
Degree of Saturation (%):	saturated	saturated

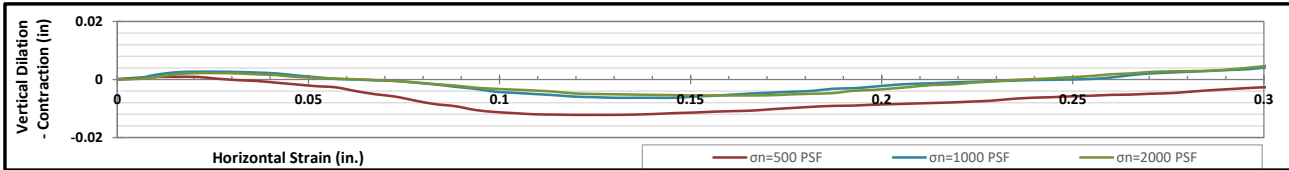
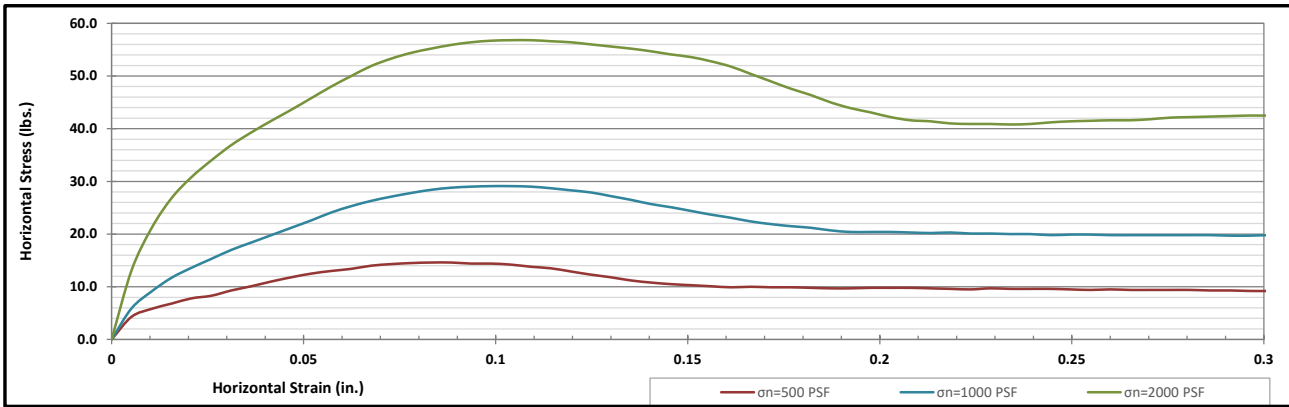
Summary of Sample Data: $\sigma_n=1000$ PSF		
Initial Moisture Content (%)	26.2	
	Initial	Post-Consolidation
Dry Density (PCF):	107.6	110.8
Void Ratio:	0.566	0.521
Porosity (%):	36.1	34.3
Degree of Saturation (%):	saturated	saturated

Summary of Sample Data: $\sigma_n=2000$ PSF		
Initial Moisture Content (%)	24.9	
	Initial	Post-Consolidation
Dry Density (PCF):	108.8	113.7
Void Ratio:	0.549	0.481
Porosity (%):	35.4	32.5
Degree of Saturation (%):	saturated	saturated

ESTIMATED STRENGTH PARAMETERS		
	PEAK	RESIDUAL
Angle of Internal Friction, $\phi$ (°):	40	32
Cohesion (PSF):	0	0



Failure Envelope Test Values:			
Normal Stress, $\sigma_n$ (PSF):	500	1000	2000
Peak Horizontal Stress, $\tau_h$ (PSF):	430	860	1670
Residual Horizontal Stress, $\tau_r$ (PSF):	260	580	1280



Corporate • 777 Chrysler Drive • Burlington, WA 98233 • Phone 360.755.1990 • Fax 360.755.1980  
 SW Region • 2118 Black Lake Blvd. S.W. • Olympia, WA 98512 • Phone 360.534.9777 • Fax 360.534.9779  
 NW Region • 805 Dupont, Suite #5 • Bellingham, WA 98225 • Phone 360.647.6061 • Fax 360.647.8111  
 Kitsap Region • 5451 N.W. Newberry Hill Road, Suite 101 • Silverdale, WA 98383 • Phone/Fax 360.698.6787

Visit our website: [www.mtc-inc.net](http://www.mtc-inc.net)

# Sieve Report

<b>Project:</b> Q.C. - Lower Duwamish Waterway <b>Project #:</b> 21B233 <b>Client:</b> Anchor QEA <b>Source:</b> LDW21-GT21-GB-21-25.7 ft <b>Sample#:</b> B21-1445	<b>Date Received:</b> 29-Jul-21 <b>Sampled By:</b> Client <b>Date Tested:</b> 23-Aug-21 <b>Tested By:</b> A. Eifrig	<b>Visual Identification</b> Sandy Silt <b>Sample Color:</b> grayish-brown
--	--	---



**ASTM D2216, ASTM D2419, ASTM D4318, ASTM D5281**

**Specifications**

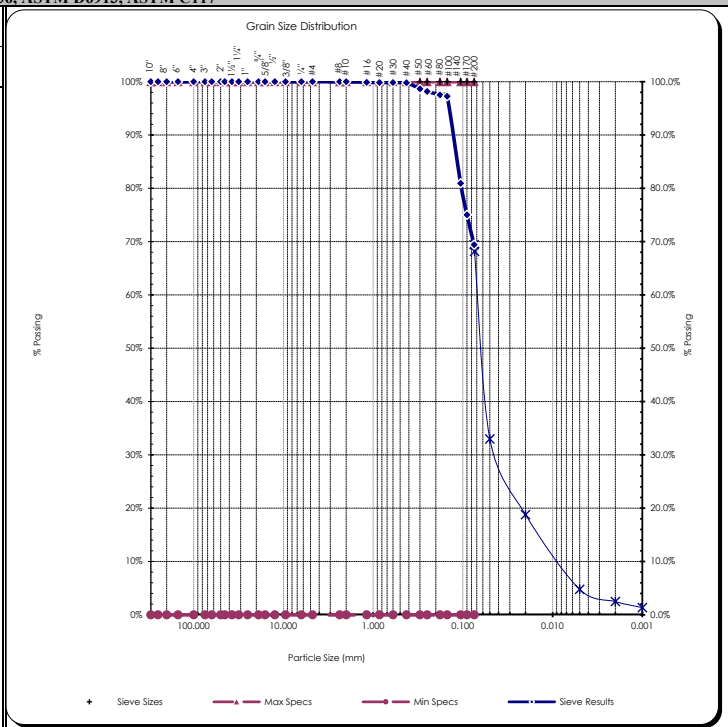
No Specs

Sample Meets Specs ? **N/A**

$D_{(5)} = 0.005$ mm $D_{(10)} = 0.010$ mm $D_{(15)} = 0.015$ mm $D_{(30)} = 0.040$ mm $D_{(50)} = 0.060$ mm $D_{(60)} = 0.068$ mm $D_{(90)} = 0.130$ mm Dust Ratio = 16/23	% Gravel = 0.0% % Sand = 30.5% % Silt & Clay = 69.5% Liquid Limit = n/a Plasticity Index = n/a Sand Equivalent = n/a Fracture %, 1 Face = n/a Fracture %, 2+ Faces = n/a	Coeff. of Curvature, $C_c = 2.30$ Coeff. of Uniformity, $C_u = 6.70$ Fineness Modulus = 0.04 Plastic Limit = n/a Moisture %, as sampled = 35.7% Req'd Sand Equivalent = Req'd Fracture %, 1 Face = Req'd Fracture %, 2+ Faces =
--	---	--

**ASTM C136, ASTM D6913, ASTM C117**

Sieve Size		Actual Cumulative Percent Passing	Interpolated Cumulative Percent Passing	Specs Max	Specs Min
US	Metric				
12.00"	300.00		100%	100.0%	0.0%
10.00"	250.00		100%	100.0%	0.0%
8.00"	200.00		100%	100.0%	0.0%
6.00"	150.00		100%	100.0%	0.0%
4.00"	100.00		100%	100.0%	0.0%
3.00"	75.00		100%	100.0%	0.0%
2.50"	63.00		100%	100.0%	0.0%
2.00"	50.00		100%	100.0%	0.0%
1.75"	45.00		100%	100.0%	0.0%
1.50"	37.50		100%	100.0%	0.0%
1.25"	31.50		100%	100.0%	0.0%
1.00"	25.00		100%	100.0%	0.0%
3/4"	19.00		100%	100.0%	0.0%
5/8"	16.00		100%	100.0%	0.0%
1/2"	12.50		100%	100.0%	0.0%
3/8"	9.50	100%	100%	100.0%	0.0%
1/4"	6.30		100%	100.0%	0.0%
#4	4.75	100%	100%	100.0%	0.0%
#8	2.36		100%	100.0%	0.0%
#10	2.00	100%	100%	100.0%	0.0%
#16	1.18		100%	100.0%	0.0%
#20	0.850		100%	100.0%	0.0%
#30	0.600		100%	100.0%	0.0%
#40	0.425	100%	100%	100.0%	0.0%
#50	0.300		99%	100.0%	0.0%
#60	0.250		98%	100.0%	0.0%
#80	0.180		98%	100.0%	0.0%
#100	0.150	97%	97%	100.0%	0.0%
#140	0.106		81%	100.0%	0.0%
#170	0.090		75%	100.0%	0.0%
#200	0.075	69.5%	69.5%	100.0%	0.0%



Copyright Spears Engineering & Technical Services PS, 1996-98

All results apply only to actual locations and materials tested. As a mutual protection to clients, the public and ourselves, all reports are submitted as the confidential property of clients, and authorization for publication of statements, conclusions or extracts from or regarding our reports is reserved pending our written approval.

**Comments:**

Reviewed by:   
 Meghan Blodgett-Carrillo

## Hydrometer Report

<b>Project:</b> Q.C. - Lower Duwamish Waterway <b>Project #:</b> 21B233 <b>Client:</b> Anchor QEA <b>Source:</b> LDW21-GT21-GB-21-25.7 ft <b>Sample#:</b> B21-1445	<b>Date Received:</b> 29-Jul-21 <b>Sampled By:</b> Client <b>Date Tested:</b> 23-Aug-21 <b>Tested By:</b> A. Eifrig	<b>Visual Identification</b> Sandy Silt <b>Sample Color</b> grayish-brown																																																																					
<b>ASTM D7928, HYDROMETER ANALYSIS</b>		<b>ASTM D6913</b>																																																																					
<b>Sp Gr :</b> 2.55 <b>Sample Weight:</b> 51.07 grams <b>Hydroscopic Moist.:</b> 0.72% <b>Adj. Sample Wgt :</b> 50.70 grams																																																																							
<table style="width: 100%; border-collapse: collapse;"> <thead> <tr> <th style="text-align: left;">Hydrometer Reading</th> <th style="text-align: left;">Corrected Reading</th> <th style="text-align: left;">Percent Passing</th> <th style="text-align: left;">Soils Particle Diameter</th> </tr> </thead> <tbody> <tr><td>1</td><td>19.5</td><td>39.2%</td><td>0.0512 mm</td></tr> <tr><td>2</td><td>14</td><td>28.2%</td><td>0.0373 mm</td></tr> <tr><td>4</td><td>12</td><td>24.1%</td><td>0.0266 mm</td></tr> <tr><td>15</td><td>7</td><td>14.1%</td><td>0.0142 mm</td></tr> <tr><td>30</td><td>5</td><td>10.1%</td><td>0.0101 mm</td></tr> <tr><td>60</td><td>3</td><td>6.0%</td><td>0.0072 mm</td></tr> <tr><td>240</td><td>2</td><td>4.0%</td><td>0.0036 mm</td></tr> <tr><td>1440</td><td>1</td><td>2.0%</td><td>0.0015 mm</td></tr> </tbody> </table>			Hydrometer Reading	Corrected Reading	Percent Passing	Soils Particle Diameter	1	19.5	39.2%	0.0512 mm	2	14	28.2%	0.0373 mm	4	12	24.1%	0.0266 mm	15	7	14.1%	0.0142 mm	30	5	10.1%	0.0101 mm	60	3	6.0%	0.0072 mm	240	2	4.0%	0.0036 mm	1440	1	2.0%	0.0015 mm																																	
Hydrometer Reading	Corrected Reading	Percent Passing	Soils Particle Diameter																																																																				
1	19.5	39.2%	0.0512 mm																																																																				
2	14	28.2%	0.0373 mm																																																																				
4	12	24.1%	0.0266 mm																																																																				
15	7	14.1%	0.0142 mm																																																																				
30	5	10.1%	0.0101 mm																																																																				
60	3	6.0%	0.0072 mm																																																																				
240	2	4.0%	0.0036 mm																																																																				
1440	1	2.0%	0.0015 mm																																																																				
<b>% Gravel:</b> 0.0% <b>% Sand:</b> 30.5% <b>% Silt:</b> 64.7% <b>% Clay:</b> 4.8%		<b>Sieve Analysis</b> <b>Grain Size Distribution</b> <table style="width: 100%; border-collapse: collapse;"> <thead> <tr> <th style="text-align: left;">Sieve Size</th> <th style="text-align: left;">Percent Passing</th> <th style="text-align: left;">Soils Particle Diameter</th> </tr> </thead> <tbody> <tr><td>3.0"</td><td>100%</td><td>75.000 mm</td></tr> <tr><td>2.0"</td><td>100%</td><td>50.000 mm</td></tr> <tr><td>1.5"</td><td>100%</td><td>37.500 mm</td></tr> <tr><td>1.25"</td><td>100%</td><td>31.500 mm</td></tr> <tr><td>1.0"</td><td>100%</td><td>25.000 mm</td></tr> <tr><td>3/4"</td><td>100%</td><td>19.000 mm</td></tr> <tr><td>5/8"</td><td>100%</td><td>16.000 mm</td></tr> <tr><td>1/2"</td><td>100%</td><td>12.500 mm</td></tr> <tr><td>3/8"</td><td>100%</td><td>9.500 mm</td></tr> <tr><td>1/4"</td><td>100%</td><td>6.300 mm</td></tr> <tr><td>#4</td><td>100%</td><td>4.750 mm</td></tr> <tr><td>#10</td><td>100%</td><td>2.000 mm</td></tr> <tr><td>#20</td><td>100%</td><td>0.850 mm</td></tr> <tr><td>#40</td><td>100%</td><td>0.425 mm</td></tr> <tr><td>#100</td><td>97%</td><td>0.150 mm</td></tr> <tr><td>#200</td><td>69.5%</td><td>0.075 mm</td></tr> <tr><td><b>Silts</b></td><td>68.2%</td><td>0.074 mm</td></tr> <tr><td></td><td>33.0%</td><td>0.050 mm</td></tr> <tr><td></td><td>18.8%</td><td>0.020 mm</td></tr> <tr><td><b>Clays</b></td><td>4.8%</td><td>0.005 mm</td></tr> <tr><td></td><td>2.5%</td><td>0.002 mm</td></tr> <tr><td><b>Colloids</b></td><td>1.4%</td><td>0.001 mm</td></tr> </tbody> </table>	Sieve Size	Percent Passing	Soils Particle Diameter	3.0"	100%	75.000 mm	2.0"	100%	50.000 mm	1.5"	100%	37.500 mm	1.25"	100%	31.500 mm	1.0"	100%	25.000 mm	3/4"	100%	19.000 mm	5/8"	100%	16.000 mm	1/2"	100%	12.500 mm	3/8"	100%	9.500 mm	1/4"	100%	6.300 mm	#4	100%	4.750 mm	#10	100%	2.000 mm	#20	100%	0.850 mm	#40	100%	0.425 mm	#100	97%	0.150 mm	#200	69.5%	0.075 mm	<b>Silts</b>	68.2%	0.074 mm		33.0%	0.050 mm		18.8%	0.020 mm	<b>Clays</b>	4.8%	0.005 mm		2.5%	0.002 mm	<b>Colloids</b>	1.4%	0.001 mm
Sieve Size	Percent Passing	Soils Particle Diameter																																																																					
3.0"	100%	75.000 mm																																																																					
2.0"	100%	50.000 mm																																																																					
1.5"	100%	37.500 mm																																																																					
1.25"	100%	31.500 mm																																																																					
1.0"	100%	25.000 mm																																																																					
3/4"	100%	19.000 mm																																																																					
5/8"	100%	16.000 mm																																																																					
1/2"	100%	12.500 mm																																																																					
3/8"	100%	9.500 mm																																																																					
1/4"	100%	6.300 mm																																																																					
#4	100%	4.750 mm																																																																					
#10	100%	2.000 mm																																																																					
#20	100%	0.850 mm																																																																					
#40	100%	0.425 mm																																																																					
#100	97%	0.150 mm																																																																					
#200	69.5%	0.075 mm																																																																					
<b>Silts</b>	68.2%	0.074 mm																																																																					
	33.0%	0.050 mm																																																																					
	18.8%	0.020 mm																																																																					
<b>Clays</b>	4.8%	0.005 mm																																																																					
	2.5%	0.002 mm																																																																					
<b>Colloids</b>	1.4%	0.001 mm																																																																					
<b>USDA Soil Textural Classification</b>																																																																							
<table style="width: 100%; border-collapse: collapse;"> <thead> <tr> <th style="text-align: left;">Particle Size</th> <th style="text-align: left;">Particle Size</th> </tr> </thead> <tbody> <tr><td><b>% Sand:</b></td><td>2.0 - 0.05 mm</td></tr> <tr><td><b>% Silt:</b></td><td>0.05 - 0.002 mm</td></tr> <tr><td><b>% Clay:</b></td><td>&lt; 0.002 mm</td></tr> </tbody> </table>		Particle Size	Particle Size	<b>% Sand:</b>	2.0 - 0.05 mm	<b>% Silt:</b>	0.05 - 0.002 mm	<b>% Clay:</b>	< 0.002 mm																																																														
Particle Size	Particle Size																																																																						
<b>% Sand:</b>	2.0 - 0.05 mm																																																																						
<b>% Silt:</b>	0.05 - 0.002 mm																																																																						
<b>% Clay:</b>	< 0.002 mm																																																																						
<b>USDA Soil Textural Classification</b> Sandy Loam																																																																							

All results apply only to actual locations and materials tested. As a mutual protection to clients, the public and ourselves, all reports are submitted as the confidential property of clients, and authorization for publication of statements, conclusions or extracts from or regarding our reports is reserved pending our written approval.

**Comments:** \_\_\_\_\_  
 \_\_\_\_\_  
 \_\_\_\_\_

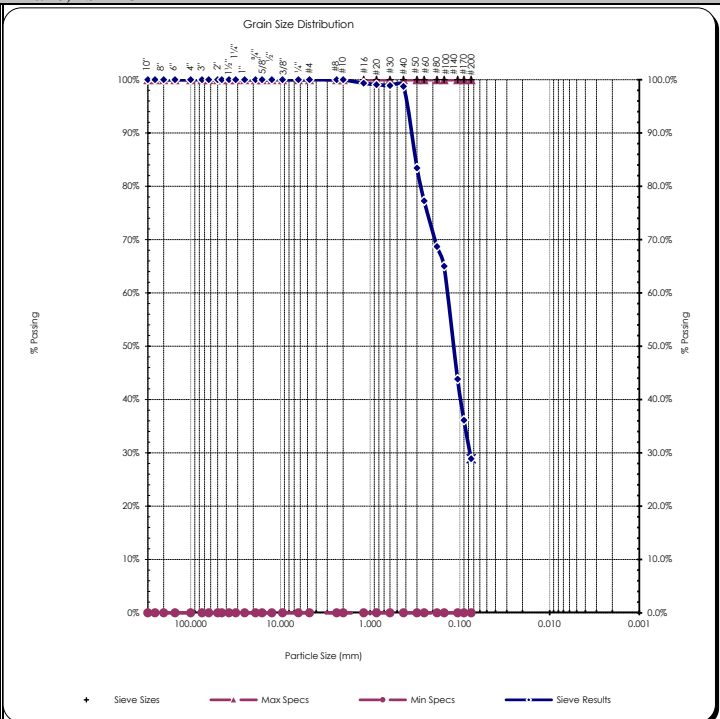
**Reviewed by:**   
 \_\_\_\_\_  
 Meghan Blodgett-Carrillo

# Sieve Report

<b>Project:</b> Q.C. - Lower Duwamish Waterway <b>Project #:</b> 21B233 <b>Client:</b> Anchor QEA <b>Source:</b> LDW21-GT21-GB-26-31 ft <b>Sample#:</b> B21-1446	<b>Date Received:</b> 29-Jul-21 <b>Sampled By:</b> Client <b>Date Tested:</b> 23-Aug-21 <b>Tested By:</b> A. Eifrig	<b>Unified Soils Classification System, ASTM D-2487</b> SM, Silty Sand <b>Sample Color:</b> gray	 <b>ACCREDITED</b> Certificate #: 1366.01
--	--	---	---

<b>ASTM D2216, ASTM D2419, ASTM D4318, ASTM D5281</b>			
<b>Specifications</b> No Specs <b>Sample Meets Specs ? N/A</b>	D <sub>(5)</sub> = 0.013 mm D <sub>(10)</sub> = 0.026 mm D <sub>(15)</sub> = 0.039 mm D <sub>(30)</sub> = 0.077 mm D <sub>(50)</sub> = 0.119 mm D <sub>(60)</sub> = 0.140 mm D <sub>(90)</sub> = 0.354 mm Dust Ratio = 12/41	% Gravel = 0.0% % Sand = 71.1% % Silt & Clay = 28.9% Liquid Limit = n/a Plasticity Index = n/a Sand Equivalent = n/a Fracture %, 1 Face = n/a Fracture %, 2+ Faces = n/a	Coeff. of Curvature, C <sub>c</sub> = 1.65 Coeff. of Uniformity, C <sub>u</sub> = 5.38 Fineness Modulus = 0.53 Plastic Limit = n/a Moisture %, as sampled = 34.2% Req'd Sand Equivalent = Req'd Fracture %, 1 Face = Req'd Fracture %, 2+ Faces =

<b>ASTM C136, ASTM D6913, ASTM C117</b>					
Sieve Size		Actual Cumulative Percent Passing	Interpolated Cumulative Percent Passing	Specs Max	Specs Min
US	Metric				
12.00"	300.00		100%	100.0%	0.0%
10.00"	250.00		100%	100.0%	0.0%
8.00"	200.00		100%	100.0%	0.0%
6.00"	150.00		100%	100.0%	0.0%
4.00"	100.00		100%	100.0%	0.0%
3.00"	75.00		100%	100.0%	0.0%
2.50"	63.00		100%	100.0%	0.0%
2.00"	50.00		100%	100.0%	0.0%
1.75"	45.00		100%	100.0%	0.0%
1.50"	37.50		100%	100.0%	0.0%
1.25"	31.50		100%	100.0%	0.0%
1.00"	25.00	100%	100%	100.0%	0.0%
3/4"	19.00	100%	100%	100.0%	0.0%
5/8"	16.00		100%	100.0%	0.0%
1/2"	12.50	100%	100%	100.0%	0.0%
3/8"	9.50	100%	100%	100.0%	0.0%
1/4"	6.30		100%	100.0%	0.0%
#4	4.75	100%	100%	100.0%	0.0%
#8	2.36		100%	100.0%	0.0%
#10	2.00	100%	100%	100.0%	0.0%
#16	1.18		99%	100.0%	0.0%
#20	0.850		99%	100.0%	0.0%
#30	0.600		99%	100.0%	0.0%
#40	0.425	99%	99%	100.0%	0.0%
#50	0.300		83%	100.0%	0.0%
#60	0.250		77%	100.0%	0.0%
#80	0.180		69%	100.0%	0.0%
#100	0.150	65%	65%	100.0%	0.0%
#140	0.106		44%	100.0%	0.0%
#170	0.090		36%	100.0%	0.0%
#200	0.075	28.9%	28.9%	100.0%	0.0%



Copyright Spears Engineering & Technical Services PS, 1996-98  
 All results apply only to actual locations and materials tested. As a mutual protection to clients, the public and ourselves, all reports are submitted as the confidential property of clients, and authorization for publication of statements, conclusions or extracts from or regarding our reports is reserved pending our written approval.

**Comments:** \_\_\_\_\_

Reviewed by:   
 Meghan Blodgett-Carrillo



**Client:** Anchor QEA  
**Address:** 21328 2nd Drive SE  
Bothell, WA 98021  
**Attn:** Garrett Timm  
**Revised on:** \_\_\_\_\_

**Date:** September 28, 2021  
**Project:** Q.C. - Lower Duwamish Waterway  
**Project #:** 21B233  
**Sample #:** B21-1321 - 1335  
**Date sampled:** 7-26-21 & 7-27-21

As requested MTC, Inc. has performed the following test(s) on the sample referenced above. The testing was performed in accordance with current applicable AASHTO or ASTM standards as indicated below. The results obtained in our laboratory were as follows below or on the attached pages:

	Test(s) Performed:	Test Results		Test(s) Performed:	Test Results
X	Sieve Analysis	Please See Attached Reports		Sulfate Soundness	
	Proctor			Bulk Density & Voids	
	Sand Equivalent			WSDOT Degradation	
	Fracture Count			LA Abrasion	
X	Moisture Content	Please See Attached Report	X	Direct Shear	Please See Attached Reports
	Specific Gravity, Coarse		X	Specific Gravity, Soils	Please See Attached Reports
	Specific Gravity, Fine				
X	Hydrometer Analysis	Please See Attached Reports			
X	Atterberg Limits	Please See Attached Reports			

If you have any questions concerning the test results, the procedures used, or if we can be of any further assistance please call on us at the number below.

Respectfully Submitted,  
 Meghan Blodgett-Carrillo  
 WABO Supervising Laboratory Technician




### Moisture Content - ASTM C566, ASTM D2216

**Project:** Q.C. - Lower Duwamish Waterway  
**Project #:** 21B233  
**Date Received:** July 29, 2021  
**Date Tested:** August 24, 2021

**Client:** Anchor QEA  
**Sampled by:** Client  
**Tested by:** A. Eifrig

Sample #	Location	Tare	Wet + Tare	Dry + Tare	Wgt. Of Moisture	Wgt. Of Soil	% Moisture
B21-1321	LDW21-GT24-0-5 ft	233.2	648.4	595.4	53.0	362.2	14.6%
B21-1322	LDW21-GT24-5-13.6ft	234.1	1046.2	877.7	168.5	643.6	26.2%
B21-1323	LDW21-GT24-13.6-29 ft	232.6	1197.1	1046.9	150.2	814.3	18.4%
B21-1324	LDW21-GT24-33-35 ft	229.5	540.4	454.5	85.9	225.0	38.2%
B21-1325	LDW21-GT24-35-43 ft	233.3	1203.4	995.3	208.1	762.0	27.3%
B21-1326	LDW21-GT24-43-50 ft	223.9	840.4	682.9	157.5	459.0	34.3%
B21-1327	LDW21-GT24-53.3-59 ft	234.6	1087.0	874.9	212.1	640.3	33.1%
B21-1328	LDW21-GT36-0-3.6 ft	215.2	760.8	729.9	30.9	514.7	6.0%
B21-1329	LDW21-GT36-3.6-6.2 ft	217.1	499.1	461.2	37.9	244.1	15.5%
B21-1330	LDW21-GT36-6.2-9.5 ft	91.9	740.7	600.6	140.1	508.7	27.5%
B21-1331	LDW21-GT36-9.5-11.7 ft	221.2	864.4	682.7	181.7	461.5	39.4%
B21-1332	LDW21-GT36-11.7-32 ft	215.5	1106.1	985.3	120.8	769.8	15.7%
B21-1333	LDW21-GT36-32-34.7 ft	223.9	674.7	563.9	110.8	340.0	32.6%
B21-1334	LDW21-GT36-34.7-50 ft	759.4	1828.1	1623.0	205.1	863.6	23.7%
B21-1335	LDW21-GT36-50.5-61.5 ft	233.5	678.3	545.8	132.5	312.3	42.4%

All results apply only to actual locations and materials tested. As a mutual protection to clients, the public and ourselves, all reports are submitted as the confidential property of clients, and authorization for publication of statements, conclusions or extracts from or regarding our reports is reserved pending our written approval.

Reviewed by:   
 Meghan Blodgett-Carrillo



**Moisture Content - ASTM D854**

**Project:** Q.C. - Lower Duwamish Waterway

**Client:** Anchor QEA

**Project #:** 21B233

**Date Received:** July 29, 2021

**Sampled by:** Client

**Date Tested:** August 26, 2021

**Tested by:** A. Eifrig

Sample #	Location	Tare	Dry Soil + Tare	Mass of Dry Soil	Pycno ID	Mass of Pycno	Volume of Pycno	Density of Water @ Tx	Mass of Pycno filled w/ water & soils	Mass of Pycno filled w/ water	Temp. of Water, 0.1 *C	SpG of Soils	Temp. Correction Factor	Corrected SpG
B21-1323	LDW21-GT24-13.6-29 ft	601.52	701.51	100.0	TSA-010	180.3	499.5	0.99754	742.00	678.62	23.0	2.7311347	0.99933	2.7293049
B21-1326	LDW21-GT24-43-50 ft	497.42	571.51	74.1	TSA-017	187.9	499.4	0.99754	731.68	686.06	23.0	2.6022626	0.99933	2.600519
B21-1332	LDW21-GT36-11.7-32 ft	497.79	598.00	100.2	TSA-015	187.6	499.5	0.99754	748.84	685.87	23.0	2.6908295	0.99933	2.6890267
B21-1335	LDW21-GT36-50.5-61.5 ft	600.15	650.57	50.4	TSA-016	197.2	499.5	0.99754	726.46	695.45	23.0	2.5974523	0.99933	2.595712

All results apply only to actual locations and materials tested. As a mutual protection to clients, the public and ourselves, all reports are submitted as the confidential property of clients, and authorization for publication of statements, conclusions or extracts from or regarding our reports is reserved pending our written approval.

Reviewed by: Meghan Blodgett-Carrillo

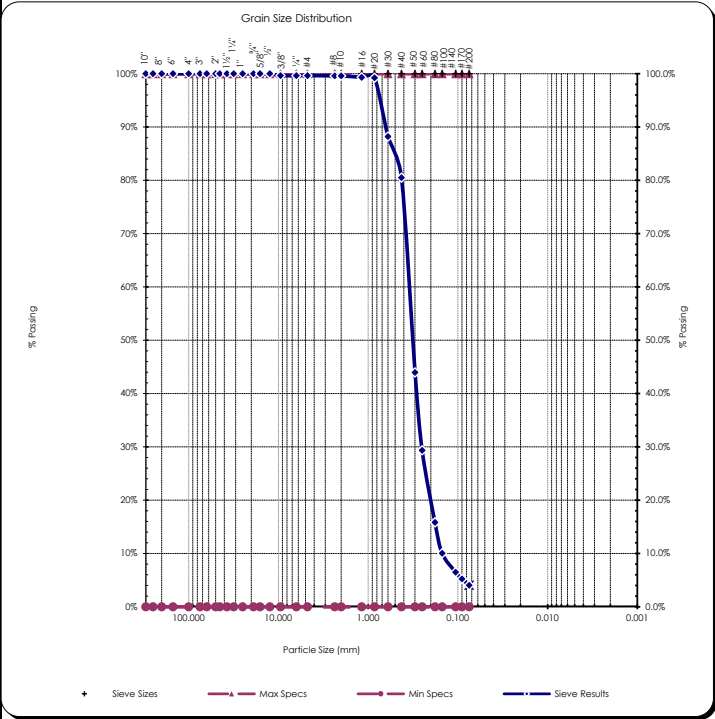


# Sieve Report

<b>Project:</b> Q.C. - Lower Duwamish Waterway <b>Project #:</b> 21B233 <b>Client:</b> Anchor QEA <b>Source:</b> LDW-GT24-5-13.6 ft <b>Sample#:</b> B21-1322	<b>Date Received:</b> 29-Jul-21 <b>Sampled By:</b> Client <b>Date Tested:</b> 24-Aug-21 <b>Tested By:</b> A. Eifrig	<b>Unified Soil Classification System, ASTM-2487</b> SP, Poorly graded Sand <b>Sample Color:</b> brown	 Certificate #: 1366.01
--	--	---	----------------------------

<b>ASTM D2216, ASTM D2419, ASTM D4318, ASTM D5281</b>			
<b>Specifications</b> No Specs <b>Sample Meets Specs ?</b> N/A	D <sub>(5)</sub> = 0.087 mm D <sub>(10)</sub> = 0.149 mm D <sub>(15)</sub> = 0.176 mm D <sub>(30)</sub> = 0.252 mm D <sub>(50)</sub> = 0.321 mm D <sub>(60)</sub> = 0.355 mm D <sub>(90)</sub> = 0.640 mm Dust Ratio = 1/20	% Gravel = 0.4% % Sand = 95.6% % Silt & Clay = 4.0% Liquid Limit = 0.0% Plasticity Index = 0.0% Sand Equivalent = n/a Fracture %, 1 Face = n/a Fracture %, 2+ Faces = n/a	Coeff. of Curvature, C <sub>c</sub> = 1.20 Coeff. of Uniformity, C <sub>u</sub> = 2.38 Fineness Modulus = 1.60 Plastic Limit = 0.0% Moisture %, as sampled = 26.2% Req'd Sand Equivalent = Req'd Fracture %, 1 Face = Req'd Fracture %, 2+ Faces =

<b>ASTM C136, ASTM D6913, ASTM C117</b>					
Sieve Size		Actual Cumulative Percent Passing	Interpolated Cumulative Percent Passing	Specs Max	Specs Min
US	Metric				
12.00"	300.00		100%	100.0%	0.0%
10.00"	250.00		100%	100.0%	0.0%
8.00"	200.00		100%	100.0%	0.0%
6.00"	150.00		100%	100.0%	0.0%
4.00"	100.00		100%	100.0%	0.0%
3.00"	75.00		100%	100.0%	0.0%
2.50"	63.00		100%	100.0%	0.0%
2.00"	50.00	100%	100%	100.0%	0.0%
1.75"	45.00	100%	100%	100.0%	0.0%
1.50"	37.50	100%	100%	100.0%	0.0%
1.25"	31.50	100%	100%	100.0%	0.0%
1.00"	25.00	100%	100%	100.0%	0.0%
3/4"	19.00	100%	100%	100.0%	0.0%
5/8"	16.00	100%	100%	100.0%	0.0%
1/2"	12.50	100%	100%	100.0%	0.0%
3/8"	9.50	100%	100%	100.0%	0.0%
1/4"	6.30	100%	100%	100.0%	0.0%
#4	4.75	100%	100%	100.0%	0.0%
#8	2.36	100%	100%	100.0%	0.0%
#10	2.00	100%	100%	100.0%	0.0%
#16	1.18	99%	99%	100.0%	0.0%
#20	0.850	99%	99%	100.0%	0.0%
#30	0.600	88%	88%	100.0%	0.0%
#40	0.425	81%	81%	100.0%	0.0%
#50	0.300	44%	44%	100.0%	0.0%
#60	0.250	29%	29%	100.0%	0.0%
#80	0.180	16%	16%	100.0%	0.0%
#100	0.150	10%	10%	100.0%	0.0%
#140	0.106	7%	7%	100.0%	0.0%
#170	0.090	5%	5%	100.0%	0.0%
#200	0.075	4.0%	4.0%	100.0%	0.0%



Copyright Spears Engineering & Technical Services PS, 1996-98  
 All results apply only to actual locations and materials tested. As a mutual protection to clients, the public and ourselves, all reports are submitted as the confidential property of clients, and authorization for publication of statements, conclusions or extracts from or regarding our reports is reserved pending our written approval.

**Comments:** \_\_\_\_\_

Reviewed by:   
 Meghan Blodgett-Carrillo

# Direct Shear Test Results:

ASTM D-3080



Project: Q.C. - Lower Duwamish Waterway  
 Project Number: 21B233  
 Laboratory Sample ID: B21-1322  
 Sample Date: 7/26/2021  
 Test Date: 8/24/2021  
 Technician: M. Carrillo

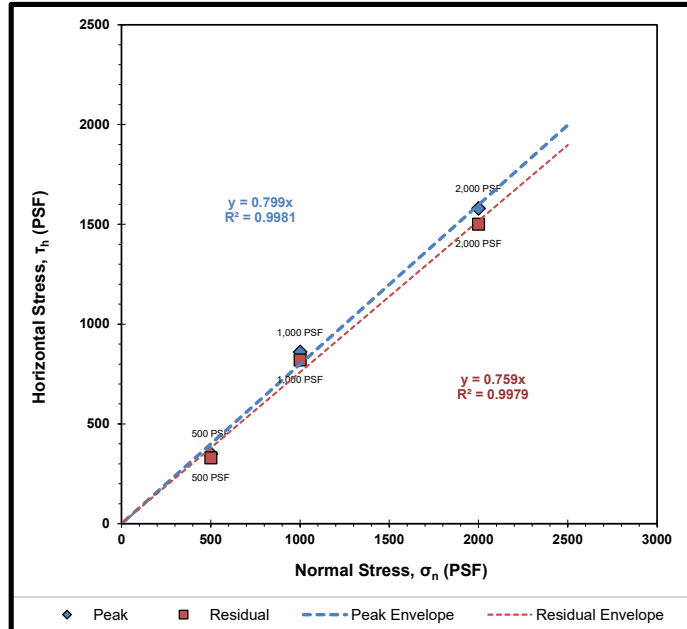
Sample Source: LDW-GT24-5-13.6 ft  
 Visual Soil Description: brown sand with silt  
 Type of Specimen: Remolded Cylindrical Shear Box  
 Specimen Diameter (in): 2.5  
 Specimen Height (in): 1  
 Rate of Strain (in/min): 0.0208  
 Estimated Specific Gravity of Solids: 2.65

Summary of Sample Data: $\sigma_n=500$ PSF		
Initial Moisture Content (%)	26.4	
	Initial	Post-Consolidation
Dry Density (PCF):	108.1	108.3
Void Ratio:	0.559	0.556
Porosity (%):	35.9	35.7
Degree of Saturation (%):	saturated	saturated

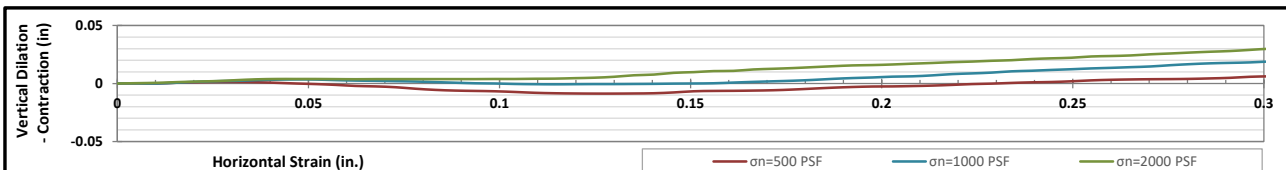
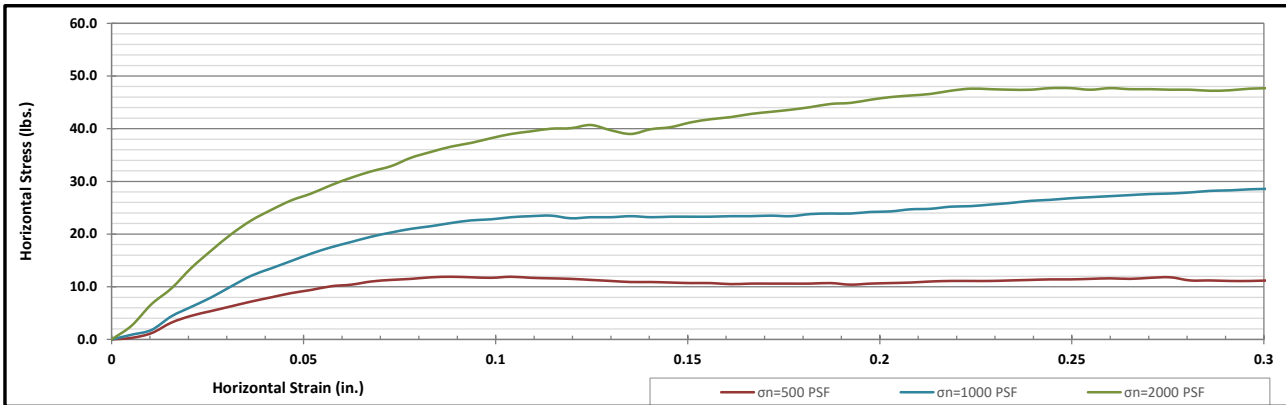
Summary of Sample Data: $\sigma_n=1000$ PSF		
Initial Moisture Content (%)	27.1	
	Initial	Post-Consolidation
Dry Density (PCF):	107.4	109.3
Void Ratio:	0.569	0.541
Porosity (%):	36.3	35.1
Degree of Saturation (%):	saturated	saturated

Summary of Sample Data: $\sigma_n=2000$ PSF		
Initial Moisture Content (%)	29.0	
	Initial	Post-Consolidation
Dry Density (PCF):	105.6	108.6
Void Ratio:	0.595	0.551
Porosity (%):	37.3	35.5
Degree of Saturation (%):	saturated	saturated

ESTIMATED STRENGTH PARAMETERS		
	PEAK	RESIDUAL
Angle of Internal Friction, $\phi$ (°):	39	37
Cohesion (PSF):	0	0



Failure Envelope Test Values:			
Normal Stress, $\sigma_n$ (PSF):	500	1000	2000
Peak Horizontal Stress, $\tau_h$ (PSF):	350	860	1580
Residual Horizontal Stress, $\tau_r$ (PSF):	330	820	1500



Corporate • 777 Chrysler Drive • Burlington, WA 98233 • Phone 360.755.1990 • Fax 360.755.1980  
 SW Region • 2118 Black Lake Blvd. S.W. • Olympia, WA 98512 • Phone 360.534.9777 • Fax 360.534.9779  
 NW Region • 805 Dupont, Suite #5 • Bellingham, WA 98225 • Phone 360.647.6061 • Fax 360.647.8111  
 Kitsap Region • 5451 N.W. Newberry Hill Road, Suite 101 • Silverdale, WA 98383 • Phone/Fax 360.698.6787

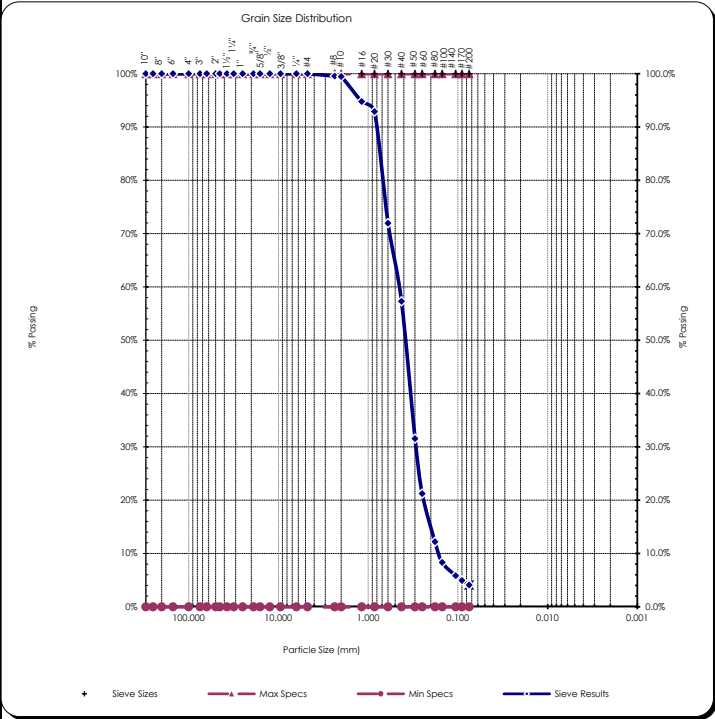
Visit our website: [www.mtc-inc.net](http://www.mtc-inc.net)

# Sieve Report

<b>Project:</b> Q.C. - Lower Duwamish Waterway <b>Project #:</b> 21B233 <b>Client:</b> Anchor QEA <b>Source:</b> LDW-GT24-13.6-29 ft <b>Sample#:</b> B21-1323	<b>Date Received:</b> 29-Jul-21 <b>Sampled By:</b> Client <b>Date Tested:</b> 24-Aug-21 <b>Tested By:</b> A. Eifrig	<b>Unified Soil Classification System, ASTM-2487</b> SP, Poorly graded Sand <b>Sample Color:</b> brown	 <b>ACCREDITED</b> Certificate #: 1366.01
---	--	---	---

<b>ASTM D2216, ASTM D2419, ASTM D4318, ASTM D5281</b>			
<b>Specifications</b> No Specs <b>Sample Meets Specs ?</b> N/A	D <sub>(5)</sub> = 0.091 mm D <sub>(10)</sub> = 0.163 mm D <sub>(15)</sub> = 0.201 mm D <sub>(30)</sub> = 0.292 mm D <sub>(50)</sub> = 0.389 mm D <sub>(60)</sub> = 0.457 mm D <sub>(90)</sub> = 0.815 mm Dust Ratio = 1/14	% Gravel = 0.0% % Sand = 95.9% % Silt & Clay = 4.1% Liquid Limit = 0.0% Plasticity Index = 0.0% Sand Equivalent = n/a Fracture %, 1 Face = n/a Fracture %, 2+ Faces = n/a	Coeff. of Curvature, C <sub>c</sub> = 1.15 Coeff. of Uniformity, C <sub>u</sub> = 2.81 Fineness Modulus = 1.94 Plastic Limit = 0.0% Moisture %, as sampled = 18.4% Req'd Sand Equivalent = Req'd Fracture %, 1 Face = Req'd Fracture %, 2+ Faces =

<b>ASTM C136, ASTM D6913, ASTM C117</b>					
<b>Sieve Size</b>		<b>Actual Cumulative Percent Passing</b>	<b>Interpolated Cumulative Percent Passing</b>	<b>Specs Max</b>	<b>Specs Min</b>
<b>US</b>	<b>Metric</b>				
12.00"	300.00		100%	100.0%	0.0%
10.00"	250.00		100%	100.0%	0.0%
8.00"	200.00		100%	100.0%	0.0%
6.00"	150.00		100%	100.0%	0.0%
4.00"	100.00		100%	100.0%	0.0%
3.00"	75.00		100%	100.0%	0.0%
2.50"	63.00		100%	100.0%	0.0%
2.00"	50.00	100%	100%	100.0%	0.0%
1.75"	45.00	100%	100%	100.0%	0.0%
1.50"	37.50	100%	100%	100.0%	0.0%
1.25"	31.50	100%	100%	100.0%	0.0%
1.00"	25.00	100%	100%	100.0%	0.0%
3/4"	19.00	100%	100%	100.0%	0.0%
5/8"	16.00	100%	100%	100.0%	0.0%
1/2"	12.50	100%	100%	100.0%	0.0%
3/8"	9.50	100%	100%	100.0%	0.0%
1/4"	6.30	100%	100%	100.0%	0.0%
#4	4.75	100%	100%	100.0%	0.0%
#8	2.36	100%	100%	100.0%	0.0%
#10	2.00	99%	99%	100.0%	0.0%
#16	1.18	93%	95%	100.0%	0.0%
#20	0.850	93%	93%	100.0%	0.0%
#30	0.600	72%	72%	100.0%	0.0%
#40	0.425	57%	57%	100.0%	0.0%
#50	0.300	32%	32%	100.0%	0.0%
#60	0.250	21%	21%	100.0%	0.0%
#80	0.180	12%	12%	100.0%	0.0%
#100	0.150	8%	8%	100.0%	0.0%
#140	0.106	6%	6%	100.0%	0.0%
#170	0.090	5%	5%	100.0%	0.0%
#200	0.075	4.1%	4.1%	100.0%	0.0%



Copyright Spears Engineering & Technical Services PS, 1996-98  
 All results apply only to actual locations and materials tested. As a mutual protection to clients, the public and ourselves, all reports are submitted as the confidential property of clients, and authorization for publication of statements, conclusions or extracts from or regarding our reports is reserved pending our written approval.

**Comments:** \_\_\_\_\_

Reviewed by:   
 Meghan Blodgett-Carrillo

# Materials Testing & Consulting, Inc.

Geotechnical Engineering • Special Inspections • Materials Testing • Environmental Consulting



## ASTM D4318 - Liquid Limit, Plastic Limit and Plasticity Index of Soils

<b>Project:</b> Q.C. - Lower Duwamish Waterway <b>Project #:</b> 21B233 <b>Client:</b> Anchor QEA <b>Source:</b> LDW-GT24-33-35 ft <b>Sample #:</b> B21-1324	<b>Date Received:</b> 29-Jul-21 <b>Sampled By:</b> Client <b>Date Tested:</b> 25-Aug-21 <b>Tested By:</b> C. Kriss	<b>Visual Identification</b> Sandy Silt <b>Sample Color</b> brown
<b>Liquid Limit Determination</b>		
	#1                      #2                      #3                      #4                      #5                      #6	
Weight of Wet Soils + Pan: Weight of Dry Soils + Pan: Weight of Pan: Weight of Dry Soils: Weight of Moisture: % Moisture: Number of Blows:	Liquid Limit cannot be established	
Liquid Limit @ 25 Blows: N/A Plastic Limit: N/A Plasticity Index, I <sub>p</sub> : N/A		
<b>Plastic Limit Determination</b>		
	#1                      #2                      #3                      #4                      #5                      #6	
Weight of Wet Soils + Pan: Weight of Dry Soils + Pan: Weight of Pan: Weight of Dry Soils: Weight of Moisture: % Moisture:	Plastic Limit cannot be determined	



Copyright Spears Engineering & Technical Services PS, 1996-98  
 All results apply only to actual locations and materials tested. As a mutual protection to clients, the public and ourselves, all reports are submitted as the confidential property of clients, and authorization for publication of statements, conclusions or extracts from or regarding our reports is reserved pending our written approval.

**Comments:** Liquid limit cannot be established as the material displays rapid dilation upon spreading into the cup. At lower moistures the material does not spread into the liquid limit device without tearing the soil cake. Plastic limit cannot be determined as the material does not roll down to 1/8" threads before cracking or crumbling. Non-plastic.

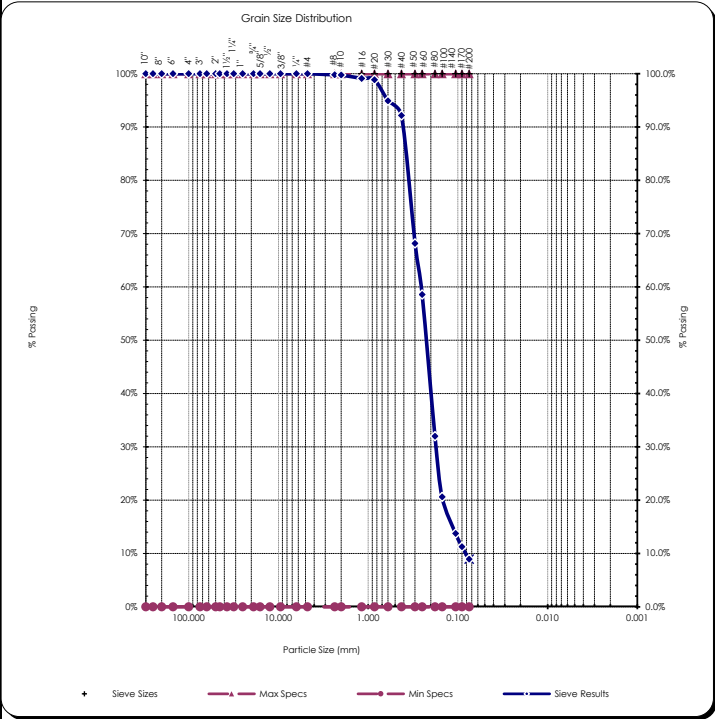
Reviewed by:   
 Meghan Blodgett-Carrillo

# Sieve Report

<b>Project:</b> Q.C. - Lower Duwamish Waterway <b>Project #:</b> 21B233 <b>Client:</b> Anchor QEA <b>Source:</b> LDW-GT24-35-43 ft <b>Sample#:</b> B21-1325	<b>Date Received:</b> 29-Jul-21 <b>Sampled By:</b> Client <b>Date Tested:</b> 24-Aug-21 <b>Tested By:</b> A. Eifrig	<b>Unified Soil Classification System, ASTM-2487</b> SP-SM, Poorly graded Sand with Silt <b>Sample Color:</b> gray	 Certificate #: 1366.01
---	--	---	----------------------------

<b>ASTM D2216, ASTM D2419, ASTM D4318, ASTM D5281</b>			
<b>Specifications</b> No Specs <b>Sample Meets Specs ? N/A</b>	D <sub>(5)</sub> = 0.042 mm D <sub>(10)</sub> = 0.082 mm D <sub>(15)</sub> = 0.114 mm D <sub>(30)</sub> = 0.175 mm D <sub>(50)</sub> = 0.227 mm D <sub>(60)</sub> = 0.257 mm D <sub>(90)</sub> = 0.414 mm Dust Ratio = 3/31	% Gravel = 0.0% % Sand = 91.1% % Silt & Clay = 8.9% Liquid Limit = 0.0% Plasticity Index = 0.0% Sand Equivalent = n/a Fracture %, 1 Face = n/a Fracture %, 2+ Faces = n/a	Coeff. of Curvature, C <sub>c</sub> = 1.45 Coeff. of Uniformity, C <sub>u</sub> = 3.14 Fineness Modulus = 1.17 Plastic Limit = 0.0% Moisture %, as sampled = 27.3% Req'd Sand Equivalent = Req'd Fracture %, 1 Face = Req'd Fracture %, 2+ Faces =

<b>ASTM C136, ASTM D6913, ASTM C117</b>					
Sieve Size		Actual Cumulative Percent Passing	Interpolated Cumulative Percent Passing	Specs Max	Specs Min
US	Metric				
12.00"	300.00		100%	100.0%	0.0%
10.00"	250.00		100%	100.0%	0.0%
8.00"	200.00		100%	100.0%	0.0%
6.00"	150.00		100%	100.0%	0.0%
4.00"	100.00		100%	100.0%	0.0%
3.00"	75.00		100%	100.0%	0.0%
2.50"	63.00		100%	100.0%	0.0%
2.00"	50.00	100%	100%	100.0%	0.0%
1.75"	45.00	100%	100%	100.0%	0.0%
1.50"	37.50	100%	100%	100.0%	0.0%
1.25"	31.50	100%	100%	100.0%	0.0%
1.00"	25.00	100%	100%	100.0%	0.0%
3/4"	19.00	100%	100%	100.0%	0.0%
5/8"	16.00	100%	100%	100.0%	0.0%
1/2"	12.50	100%	100%	100.0%	0.0%
3/8"	9.50	100%	100%	100.0%	0.0%
1/4"	6.30	100%	100%	100.0%	0.0%
#4	4.75	100%	100%	100.0%	0.0%
#8	2.36	100%	100%	100.0%	0.0%
#10	2.00	100%	100%	100.0%	0.0%
#16	1.18	99%	99%	100.0%	0.0%
#20	0.850	99%	99%	100.0%	0.0%
#30	0.600	92%	92%	100.0%	0.0%
#40	0.425	92%	92%	100.0%	0.0%
#50	0.300	68%	68%	100.0%	0.0%
#60	0.250	59%	59%	100.0%	0.0%
#80	0.180	32%	32%	100.0%	0.0%
#100	0.150	21%	21%	100.0%	0.0%
#140	0.106	14%	14%	100.0%	0.0%
#170	0.090	11%	11%	100.0%	0.0%
#200	0.075	8.9%	8.9%	100.0%	0.0%



Copyright Spears Engineering & Technical Services PS, 1996-98  
 All results apply only to actual locations and materials tested. As a mutual protection to clients, the public and ourselves, all reports are submitted as the confidential property of clients, and authorization for publication of statements, conclusions or extracts from or regarding our reports is reserved pending our written approval.

**Comments:** \_\_\_\_\_

Reviewed by:   
 Meghan Blodgett-Carrillo

# Materials Testing & Consulting, Inc.

Geotechnical Engineering • Special Inspections • Materials Testing • Environmental Consulting



## ASTM D4318 - Liquid Limit, Plastic Limit and Plasticity Index of Soils

<b>Project:</b> Q.C. - Lower Duwamish Waterway <b>Project #:</b> 21B233 <b>Client:</b> Anchor QEA <b>Source:</b> LDW-GT24-43-50 ft <b>Sample #:</b> B21-1326	<b>Date Received:</b> 29-Jul-21 <b>Sampled By:</b> Client <b>Date Tested:</b> 25-Aug-21 <b>Tested By:</b> C. Kriss	<b>Visual Identification</b> Silty Sand Sample Color dark brown					
<b>Liquid Limit Determination</b>							
	#1	#2	#3	#4	#5	#6	
<b>Weight of Wet Soils + Pan:</b>	Liquid Limit cannot be established						
<b>Weight of Dry Soils + Pan:</b>							
<b>Weight of Pan:</b>							
<b>Weight of Dry Soils:</b>							
<b>Weight of Moisture:</b>							
<b>% Moisture:</b>							
<b>Number of Blows:</b>							
<b>Plastic Limit Determination</b>			<b>Liquid Limit @ 25 Blows:</b> N/A				
	#1	#2	#3	#4	#5	#6	<b>Plastic Limit:</b> N/A
<b>Weight of Wet Soils + Pan:</b>	Plastic Limit cannot be determined						<b>Plasticity Index, I<sub>p</sub>:</b> N/A
<b>Weight of Dry Soils + Pan:</b>							
<b>Weight of Pan:</b>							
<b>Weight of Dry Soils:</b>							
<b>Weight of Moisture:</b>							
<b>% Moisture:</b>							
<b>Plasticity Chart</b>							
			<b>Liquid Limit</b>				

Copyright Spears Engineering & Technical Services PS, 1996-98  
All results apply only to actual locations and materials tested. As a mutual protection to clients, the public and ourselves, all reports are submitted as the confidential property of clients, and authorization for publication of statements, conclusions or extracts from or regarding our reports is reserved pending our written approval.

**Comments:** Liquid limit cannot be established as the material displays rapid dilation upon spreading into the cup. At lower moistures the material does not spread into the liquid limit device without tearing the soil cake. Plastic limit cannot be determined as the material does not roll down to 1/8" threads before cracking or crumbling. Non-plastic.

Reviewed by:   
Meghan Blodgett-Carrillo

Corporate ~ 777 Chrysler Drive • Burlington, WA 98233 • Phone (360) 755-1990 • Fax (360) 755-1980  
Regional Offices: Olympia ~ 360.534.9777 Bellingham ~ 360.647.6111 Silverdale ~ 360.698.6787 Tukwila ~ 206.241.1974  
Visit our website: [www.mtc-inc.net](http://www.mtc-inc.net)

# Sieve Report

<b>Project:</b> Q.C. - Lower Duwamish Waterway <b>Project #:</b> 21B233 <b>Client:</b> Anchor QEA <b>Source:</b> LDW-GT24-53.3-59 ft <b>Sample#:</b> B21-1327	<b>Date Received:</b> 29-Jul-21 <b>Sampled By:</b> Client <b>Date Tested:</b> 24-Aug-21 <b>Tested By:</b> A. Eifrig	<b>Visual Identification</b> Sandy Silt <b>Sample Color:</b> brown
---	--	---



**ASTM D2216, ASTM D2419, ASTM D4318, ASTM D5281**

**Specifications**

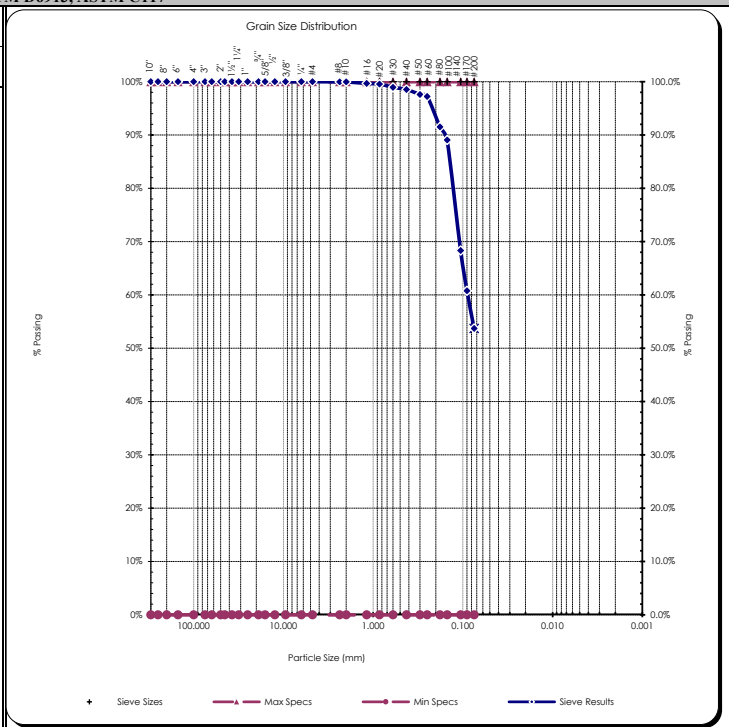
No Specs

**Sample Meets Specs ? N/A**

D <sub>(5)</sub> = 0.007 mm	% Gravel = 0.0%	Coeff. of Curvature, C <sub>c</sub> = 1.42
D <sub>(10)</sub> = 0.014 mm	% Sand = 46.3%	Coeff. of Uniformity, C <sub>u</sub> = 6.33
D <sub>(15)</sub> = 0.021 mm	% Silt & Clay = 53.7%	Fineness Modulus = 0.15
D <sub>(30)</sub> = 0.042 mm	Liquid Limit = n/a	Plastic Limit = n/a
D <sub>(50)</sub> = 0.070 mm	Plasticity Index = n/a	Moisture %, as sampled = 33.1%
D <sub>(60)</sub> = 0.088 mm	Sand Equivalent = n/a	Req'd Sand Equivalent =
D <sub>(90)</sub> = 0.161 mm	Fracture %, 1 Face = n/a	Req'd Fracture %, 1 Face =
Dust Ratio = 6/11	Fracture %, 2+ Faces = n/a	Req'd Fracture %, 2+ Faces =

**ASTM C136, ASTM D6913, ASTM C117**

Sieve Size		Actual Cumulative Percent Passing	Interpolated Cumulative Percent Passing	Specs Max	Specs Min
US	Metric				
12.00"	300.00		100%	100.0%	0.0%
10.00"	250.00		100%	100.0%	0.0%
8.00"	200.00		100%	100.0%	0.0%
6.00"	150.00		100%	100.0%	0.0%
4.00"	100.00		100%	100.0%	0.0%
3.00"	75.00		100%	100.0%	0.0%
2.50"	63.00		100%	100.0%	0.0%
2.00"	50.00	100%	100%	100.0%	0.0%
1.75"	45.00		100%	100.0%	0.0%
1.50"	37.50		100%	100.0%	0.0%
1.25"	31.50		100%	100.0%	0.0%
1.00"	25.00	100%	100%	100.0%	0.0%
3/4"	19.00	100%	100%	100.0%	0.0%
5/8"	16.00		100%	100.0%	0.0%
1/2"	12.50	100%	100%	100.0%	0.0%
3/8"	9.50	100%	100%	100.0%	0.0%
1/4"	6.30		100%	100.0%	0.0%
#4	4.75	100%	100%	100.0%	0.0%
#8	2.36		100%	100.0%	0.0%
#10	2.00	100%	100%	100.0%	0.0%
#16	1.18		100%	100.0%	0.0%
#20	0.850	100%	100%	100.0%	0.0%
#30	0.600		99%	100.0%	0.0%
#40	0.425	99%	99%	100.0%	0.0%
#50	0.300		98%	100.0%	0.0%
#60	0.250	97%	97%	100.0%	0.0%
#80	0.180		92%	100.0%	0.0%
#100	0.150	89%	89%	100.0%	0.0%
#140	0.106		68%	100.0%	0.0%
#170	0.090		61%	100.0%	0.0%
#200	0.075	53.7%	53.7%	100.0%	0.0%



Copyright Spears Engineering & Technical Services PS, 1996-98

All results apply only to actual locations and materials tested. As a mutual protection to clients, the public and ourselves, all reports are submitted as the confidential property of clients, and authorization for publication of statements, conclusions or extracts from or regarding our reports is reserved pending our written approval.

**Comments:**

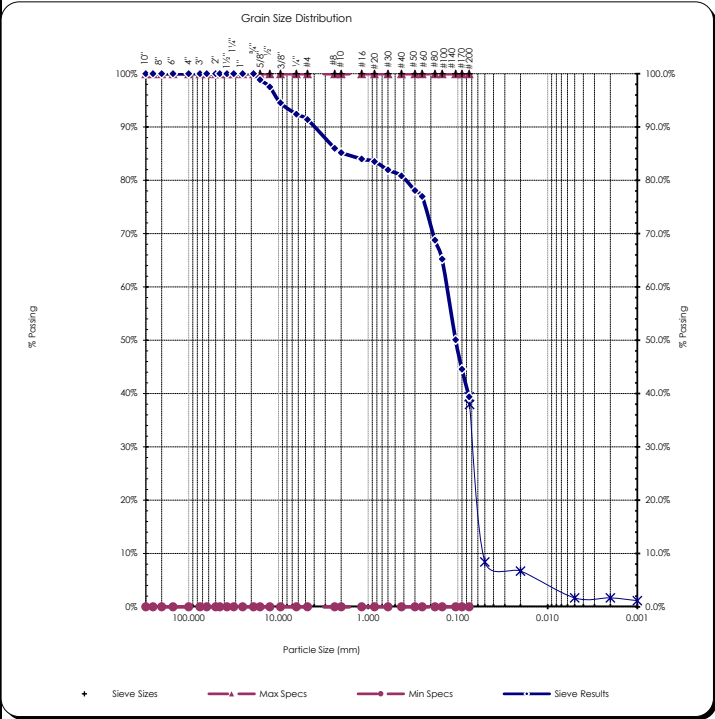
Reviewed by:   
 Meghan Blodgett-Carrillo

# Sieve Report

<b>Project:</b> Q.C. - Lower Duwamish Waterway <b>Project #:</b> 21B233 <b>Client:</b> Anchor QEA <b>Source:</b> LDW-GT36-3.6-6.2 ft <b>Sample#:</b> B21-1329	<b>Date Received:</b> 29-Jul-21 <b>Sampled By:</b> Client <b>Date Tested:</b> 24-Aug-21 <b>Tested By:</b> A. Eifrig	<b>Unified Soils Classification System, ASTM D-2487</b> SM, Silty Sand <b>Sample Color:</b> brown	 Certificate #: 1366.01
---	--	--	----------------------------

<b>ASTM D2216, ASTM D2419, ASTM D4318, ASTM D5281</b>			
<b>Specifications</b> No Specs <b>Sample Meets Specs ?</b> N/A	D <sub>(5)</sub> = 0.016 mm D <sub>(10)</sub> = 0.055 mm D <sub>(15)</sub> = 0.058 mm D <sub>(30)</sub> = 0.069 mm D <sub>(50)</sub> = 0.106 mm D <sub>(60)</sub> = 0.135 mm D <sub>(90)</sub> = 4.129 mm Dust Ratio = 39/80	% Gravel = 8.6% % Sand = 52.0% % Silt & Clay = 39.4% Liquid Limit = n/a Plasticity Index = n/a Sand Equivalent = n/a Fracture %, 1 Face = n/a Fracture %, 2+ Faces = n/a	Coeff. of Curvature, C <sub>c</sub> = 0.64 Coeff. of Uniformity, C <sub>u</sub> = 2.46 Fineness Modulus = 1.19 Plastic Limit = n/a Moisture %, as sampled = 15.5% Req'd Sand Equivalent = Req'd Fracture %, 1 Face = Req'd Fracture %, 2+ Faces =

<b>ASTM C136, ASTM D6913, ASTM C117</b>					
Sieve Size		Actual Cumulative Percent Passing	Interpolated Cumulative Percent Passing	Specs Max	Specs Min
US	Metric				
12.00"	300.00		100%	100.0%	0.0%
10.00"	250.00		100%	100.0%	0.0%
8.00"	200.00		100%	100.0%	0.0%
6.00"	150.00		100%	100.0%	0.0%
4.00"	100.00		100%	100.0%	0.0%
3.00"	75.00		100%	100.0%	0.0%
2.50"	63.00		100%	100.0%	0.0%
2.00"	50.00	100%	100%	100.0%	0.0%
1.75"	45.00	100%	100%	100.0%	0.0%
1.50"	37.50	100%	100%	100.0%	0.0%
1.25"	31.50	100%	100%	100.0%	0.0%
1.00"	25.00	100%	100%	100.0%	0.0%
3/4"	19.00	100%	100%	100.0%	0.0%
5/8"	16.00	99%	99%	100.0%	0.0%
1/2"	12.50	98%	98%	100.0%	0.0%
3/8"	9.50	95%	95%	100.0%	0.0%
1/4"	6.30	92%	92%	100.0%	0.0%
#4	4.75	91%	91%	100.0%	0.0%
#8	2.36	86%	86%	100.0%	0.0%
#10	2.00	85%	85%	100.0%	0.0%
#16	1.18	84%	84%	100.0%	0.0%
#20	0.850	84%	84%	100.0%	0.0%
#30	0.600	82%	82%	100.0%	0.0%
#40	0.425	81%	81%	100.0%	0.0%
#50	0.300	78%	78%	100.0%	0.0%
#60	0.250	77%	77%	100.0%	0.0%
#80	0.180	69%	69%	100.0%	0.0%
#100	0.150	65%	65%	100.0%	0.0%
#140	0.106	50%	50%	100.0%	0.0%
#170	0.090	45%	45%	100.0%	0.0%
#200	0.075	39.4%	39.4%	100.0%	0.0%



Copyright Spears Engineering & Technical Services PS, 1996-98  
 All results apply only to actual locations and materials tested. As a mutual protection to clients, the public and ourselves, all reports are submitted as the confidential property of clients, and authorization for publication of statements, conclusions or extracts from or regarding our reports is reserved pending our written approval.

**Comments:** \_\_\_\_\_

Reviewed by:   
 Meghan Blodgett-Carrillo



## Hydrometer Report

<b>Project:</b> Q.C. - Lower Duwamish Waterway <b>Date Received:</b> 29-Jul-21 <b>Project #:</b> 21B233 <b>Sampled By:</b> Client <b>Client:</b> Anchor QEA <b>Date Tested:</b> 24-Aug-21 <b>Source:</b> LDW-GT36-3.6-6.2 ft <b>Tested By:</b> A. Eifrig <b>Sample#:</b> B21-1329	<b>Unified Soils Classification System, ASTM D-2487</b> SM, Silty Sand <b>Sample Color</b> brown																																																																																																																																																			
<b>ASTM D7928, HYDROMETER ANALYSIS</b>	<b>ASTM D6913</b>																																																																																																																																																			
<table style="width: 100%;"> <tr> <td><b>Assumed Sp Gr :</b></td> <td style="background-color: yellow;">2.65</td> <td></td> </tr> <tr> <td><b>Sample Weight:</b></td> <td style="background-color: yellow;">50.78</td> <td>grams</td> </tr> <tr> <td><b>Hydroscopic Moist.:</b></td> <td style="background-color: yellow;">0.57%</td> <td></td> </tr> <tr> <td><b>Adj. Sample Wgt :</b></td> <td style="background-color: yellow;">50.49</td> <td>grams</td> </tr> </table> <table style="width: 100%;"> <tr> <td style="text-align: center;"><b>Hydrometer</b></td> <td></td> <td></td> <td></td> </tr> <tr> <td style="text-align: center;"><b>Reading</b></td> <td style="text-align: center;"><b>Corrected</b></td> <td style="text-align: center;"><b>Percent</b></td> <td style="text-align: center;"><b>Soils Particle</b></td> </tr> <tr> <td style="text-align: center;"><b>Minutes</b></td> <td style="text-align: center;"><b>Reading</b></td> <td style="text-align: center;"><b>Passing</b></td> <td style="text-align: center;"><b>Diameter</b></td> </tr> <tr> <td style="text-align: center;">1</td> <td style="text-align: center; background-color: yellow;">5</td> <td style="text-align: center;">8.4%</td> <td style="text-align: center;">0.0537 mm</td> </tr> <tr> <td style="text-align: center;">2</td> <td style="text-align: center; background-color: yellow;">5</td> <td style="text-align: center;">8.4%</td> <td style="text-align: center;">0.0380 mm</td> </tr> <tr> <td style="text-align: center;">5</td> <td style="text-align: center; background-color: yellow;">5</td> <td style="text-align: center;">8.4%</td> <td style="text-align: center;">0.0240 mm</td> </tr> <tr> <td style="text-align: center;">15</td> <td style="text-align: center; background-color: yellow;">2.5</td> <td style="text-align: center;">4.2%</td> <td style="text-align: center;">0.0141 mm</td> </tr> <tr> <td style="text-align: center;">30</td> <td style="text-align: center; background-color: yellow;">1</td> <td style="text-align: center;">1.7%</td> <td style="text-align: center;">0.0100 mm</td> </tr> <tr> <td style="text-align: center;">60</td> <td style="text-align: center; background-color: yellow;">1</td> <td style="text-align: center;">1.7%</td> <td style="text-align: center;">0.0071 mm</td> </tr> <tr> <td style="text-align: center;">240</td> <td style="text-align: center; background-color: yellow;">1</td> <td style="text-align: center;">1.7%</td> <td style="text-align: center;">0.0035 mm</td> </tr> <tr> <td style="text-align: center;">1440</td> <td style="text-align: center; background-color: yellow;">1</td> <td style="text-align: center;">1.7%</td> <td style="text-align: center;">0.0014 mm</td> </tr> </table> <table style="width: 100%;"> <tr> <td><b>% Gravel:</b></td> <td style="text-align: right;">8.6%</td> <td><b>Liquid Limit:</b></td> <td style="text-align: right;">n/a</td> </tr> <tr> <td><b>% Sand:</b></td> <td style="text-align: right;">52.0%</td> <td><b>Plastic Limit:</b></td> <td style="text-align: right;">n/a</td> </tr> <tr> <td><b>% Silt:</b></td> <td style="text-align: right;">37.7%</td> <td><b>Plasticity Index:</b></td> <td style="text-align: right;">n/a</td> </tr> <tr> <td><b>% Clay:</b></td> <td style="text-align: right;">1.7%</td> <td></td> <td></td> </tr> </table>	<b>Assumed Sp Gr :</b>	2.65		<b>Sample Weight:</b>	50.78	grams	<b>Hydroscopic Moist.:</b>	0.57%		<b>Adj. Sample Wgt :</b>	50.49	grams	<b>Hydrometer</b>				<b>Reading</b>	<b>Corrected</b>	<b>Percent</b>	<b>Soils Particle</b>	<b>Minutes</b>	<b>Reading</b>	<b>Passing</b>	<b>Diameter</b>	1	5	8.4%	0.0537 mm	2	5	8.4%	0.0380 mm	5	5	8.4%	0.0240 mm	15	2.5	4.2%	0.0141 mm	30	1	1.7%	0.0100 mm	60	1	1.7%	0.0071 mm	240	1	1.7%	0.0035 mm	1440	1	1.7%	0.0014 mm	<b>% Gravel:</b>	8.6%	<b>Liquid Limit:</b>	n/a	<b>% Sand:</b>	52.0%	<b>Plastic Limit:</b>	n/a	<b>% Silt:</b>	37.7%	<b>Plasticity Index:</b>	n/a	<b>% Clay:</b>	1.7%			<table style="width: 100%;"> <tr> <td colspan="3" style="text-align: center;"><b>Sieve Analysis</b></td> </tr> <tr> <td colspan="3" style="text-align: center;"><b>Grain Size Distribution</b></td> </tr> <tr> <td style="text-align: center;"><b>Sieve Size</b></td> <td style="text-align: center;"><b>Percent Passing</b></td> <td style="text-align: center;"><b>Soils Particle Diameter</b></td> </tr> <tr> <td style="text-align: center;">3.0"</td> <td style="text-align: center;">100%</td> <td style="text-align: center;">75.000 mm</td> </tr> <tr> <td style="text-align: center;">2.0"</td> <td style="text-align: center;">100%</td> <td style="text-align: center;">50.000 mm</td> </tr> <tr> <td style="text-align: center;">1.5"</td> <td style="text-align: center;">100%</td> <td style="text-align: center;">37.500 mm</td> </tr> <tr> <td style="text-align: center;">1.25"</td> <td style="text-align: center;">100%</td> <td style="text-align: center;">31.500 mm</td> </tr> <tr> <td style="text-align: center;">1.0"</td> <td style="text-align: center;">100%</td> <td style="text-align: center;">25.000 mm</td> </tr> <tr> <td style="text-align: center;">3/4"</td> <td style="text-align: center;">100%</td> <td style="text-align: center;">19.000 mm</td> </tr> <tr> <td style="text-align: center;">5/8"</td> <td style="text-align: center;">99%</td> <td style="text-align: center;">16.000 mm</td> </tr> <tr> <td style="text-align: center;">1/2"</td> <td style="text-align: center;">98%</td> <td style="text-align: center;">12.500 mm</td> </tr> <tr> <td style="text-align: center;">3/8"</td> <td style="text-align: center;">95%</td> <td style="text-align: center;">9.500 mm</td> </tr> <tr> <td style="text-align: center;">1/4"</td> <td style="text-align: center;">92%</td> <td style="text-align: center;">6.300 mm</td> </tr> <tr> <td style="text-align: center;">#4</td> <td style="text-align: center;">91%</td> <td style="text-align: center;">4.750 mm</td> </tr> <tr> <td style="text-align: center;">#10</td> <td style="text-align: center;">85%</td> <td style="text-align: center;">2.000 mm</td> </tr> <tr> <td style="text-align: center;">#20</td> <td style="text-align: center;">84%</td> <td style="text-align: center;">0.850 mm</td> </tr> <tr> <td style="text-align: center;">#40</td> <td style="text-align: center;">81%</td> <td style="text-align: center;">0.425 mm</td> </tr> <tr> <td style="text-align: center;">#100</td> <td style="text-align: center;">65%</td> <td style="text-align: center;">0.150 mm</td> </tr> <tr> <td style="text-align: center;">#200</td> <td style="text-align: center;">39.4%</td> <td style="text-align: center;">0.075 mm</td> </tr> <tr> <td style="text-align: center;"><b>Silts</b></td> <td style="text-align: center;">38.0%</td> <td style="text-align: center;">0.074 mm</td> </tr> <tr> <td></td> <td style="text-align: center;">8.4%</td> <td style="text-align: center;">0.050 mm</td> </tr> <tr> <td></td> <td style="text-align: center;">6.7%</td> <td style="text-align: center;">0.020 mm</td> </tr> <tr> <td style="text-align: center;"><b>Clays</b></td> <td style="text-align: center;">1.7%</td> <td style="text-align: center;">0.005 mm</td> </tr> <tr> <td></td> <td style="text-align: center;">1.7%</td> <td style="text-align: center;">0.002 mm</td> </tr> <tr> <td style="text-align: center;"><b>Colloids</b></td> <td style="text-align: center;">1.2%</td> <td style="text-align: center;">0.001 mm</td> </tr> </table>	<b>Sieve Analysis</b>			<b>Grain Size Distribution</b>			<b>Sieve Size</b>	<b>Percent Passing</b>	<b>Soils Particle Diameter</b>	3.0"	100%	75.000 mm	2.0"	100%	50.000 mm	1.5"	100%	37.500 mm	1.25"	100%	31.500 mm	1.0"	100%	25.000 mm	3/4"	100%	19.000 mm	5/8"	99%	16.000 mm	1/2"	98%	12.500 mm	3/8"	95%	9.500 mm	1/4"	92%	6.300 mm	#4	91%	4.750 mm	#10	85%	2.000 mm	#20	84%	0.850 mm	#40	81%	0.425 mm	#100	65%	0.150 mm	#200	39.4%	0.075 mm	<b>Silts</b>	38.0%	0.074 mm		8.4%	0.050 mm		6.7%	0.020 mm	<b>Clays</b>	1.7%	0.005 mm		1.7%	0.002 mm	<b>Colloids</b>	1.2%	0.001 mm
<b>Assumed Sp Gr :</b>	2.65																																																																																																																																																			
<b>Sample Weight:</b>	50.78	grams																																																																																																																																																		
<b>Hydroscopic Moist.:</b>	0.57%																																																																																																																																																			
<b>Adj. Sample Wgt :</b>	50.49	grams																																																																																																																																																		
<b>Hydrometer</b>																																																																																																																																																				
<b>Reading</b>	<b>Corrected</b>	<b>Percent</b>	<b>Soils Particle</b>																																																																																																																																																	
<b>Minutes</b>	<b>Reading</b>	<b>Passing</b>	<b>Diameter</b>																																																																																																																																																	
1	5	8.4%	0.0537 mm																																																																																																																																																	
2	5	8.4%	0.0380 mm																																																																																																																																																	
5	5	8.4%	0.0240 mm																																																																																																																																																	
15	2.5	4.2%	0.0141 mm																																																																																																																																																	
30	1	1.7%	0.0100 mm																																																																																																																																																	
60	1	1.7%	0.0071 mm																																																																																																																																																	
240	1	1.7%	0.0035 mm																																																																																																																																																	
1440	1	1.7%	0.0014 mm																																																																																																																																																	
<b>% Gravel:</b>	8.6%	<b>Liquid Limit:</b>	n/a																																																																																																																																																	
<b>% Sand:</b>	52.0%	<b>Plastic Limit:</b>	n/a																																																																																																																																																	
<b>% Silt:</b>	37.7%	<b>Plasticity Index:</b>	n/a																																																																																																																																																	
<b>% Clay:</b>	1.7%																																																																																																																																																			
<b>Sieve Analysis</b>																																																																																																																																																				
<b>Grain Size Distribution</b>																																																																																																																																																				
<b>Sieve Size</b>	<b>Percent Passing</b>	<b>Soils Particle Diameter</b>																																																																																																																																																		
3.0"	100%	75.000 mm																																																																																																																																																		
2.0"	100%	50.000 mm																																																																																																																																																		
1.5"	100%	37.500 mm																																																																																																																																																		
1.25"	100%	31.500 mm																																																																																																																																																		
1.0"	100%	25.000 mm																																																																																																																																																		
3/4"	100%	19.000 mm																																																																																																																																																		
5/8"	99%	16.000 mm																																																																																																																																																		
1/2"	98%	12.500 mm																																																																																																																																																		
3/8"	95%	9.500 mm																																																																																																																																																		
1/4"	92%	6.300 mm																																																																																																																																																		
#4	91%	4.750 mm																																																																																																																																																		
#10	85%	2.000 mm																																																																																																																																																		
#20	84%	0.850 mm																																																																																																																																																		
#40	81%	0.425 mm																																																																																																																																																		
#100	65%	0.150 mm																																																																																																																																																		
#200	39.4%	0.075 mm																																																																																																																																																		
<b>Silts</b>	38.0%	0.074 mm																																																																																																																																																		
	8.4%	0.050 mm																																																																																																																																																		
	6.7%	0.020 mm																																																																																																																																																		
<b>Clays</b>	1.7%	0.005 mm																																																																																																																																																		
	1.7%	0.002 mm																																																																																																																																																		
<b>Colloids</b>	1.2%	0.001 mm																																																																																																																																																		
<b>USDA Soil Textural Classification</b>																																																																																																																																																				
<table style="width: 100%;"> <tr> <td></td> <td style="text-align: center;"><b>Particle Size</b></td> </tr> <tr> <td><b>% Sand:</b></td> <td style="text-align: center;">2.0 - 0.05 mm</td> </tr> <tr> <td><b>% Silt:</b></td> <td style="text-align: center;">0.05 - 0.002 mm</td> </tr> <tr> <td><b>% Clay:</b></td> <td style="text-align: center;">&lt; 0.002 mm</td> </tr> </table> <p style="text-align: center;"><b>USDA Soil Textural Classification</b> Sand</p>		<b>Particle Size</b>	<b>% Sand:</b>	2.0 - 0.05 mm	<b>% Silt:</b>	0.05 - 0.002 mm	<b>% Clay:</b>	< 0.002 mm																																																																																																																																												
	<b>Particle Size</b>																																																																																																																																																			
<b>% Sand:</b>	2.0 - 0.05 mm																																																																																																																																																			
<b>% Silt:</b>	0.05 - 0.002 mm																																																																																																																																																			
<b>% Clay:</b>	< 0.002 mm																																																																																																																																																			

All results apply only to actual locations and materials tested. As a mutual protection to clients, the public and ourselves, all reports are submitted as the confidential property of clients, and authorization for publication of statements, conclusions or extracts from or regarding our reports is reserved pending our written approval.

**Comments:** \_\_\_\_\_  
 \_\_\_\_\_  
 \_\_\_\_\_

**Reviewed by:**   
 \_\_\_\_\_  
 Meghan Blodgett-Carrillo

# Direct Shear Test Results:

ASTM D-3080



Project: Q.C. - Lower Duwamish Waterway  
 Project Number: 21B233  
 Laboratory Sample ID: B21-1329  
 Sample Date: 7/26/2021  
 Test Date: 8/26/2021  
 Technician: M. Carrillo

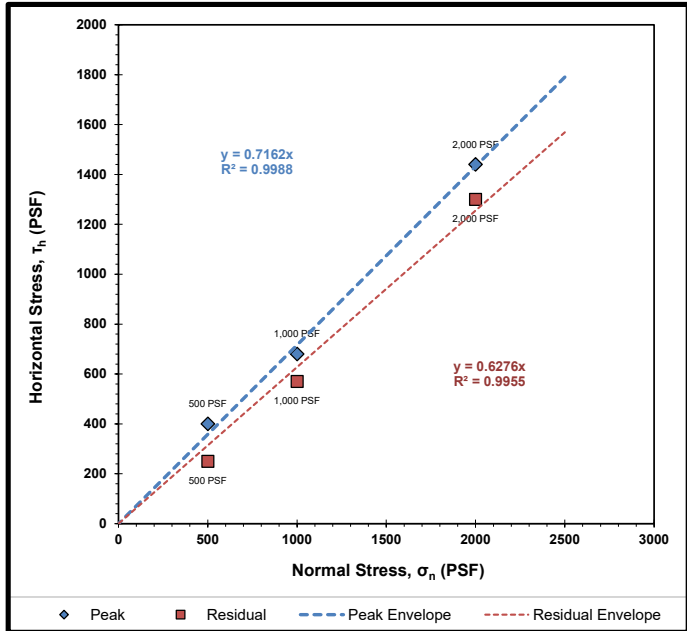
Sample Source: LDW-GT36-3.6-6.2 ft  
 Visual Soil Description: brown silty sand  
 Type of Specimen: Remolded Cylindrical Shear Box  
 Specimen Diameter (in): 2.5  
 Specimen Height (in): 1  
 Rate of Strain (in/min): 0.0208  
 Estimated Specific Gravity of Solids: 2.65

Summary of Sample Data: $\sigma_n=500$ PSF		
Initial Moisture Content (%)	19.8	
	Initial	Post-Consolidation
Dry Density (PCF):	114.5	115.4
Void Ratio:	0.472	0.460
Porosity (%):	32.1	31.5
Degree of Saturation (%):	saturated	saturated

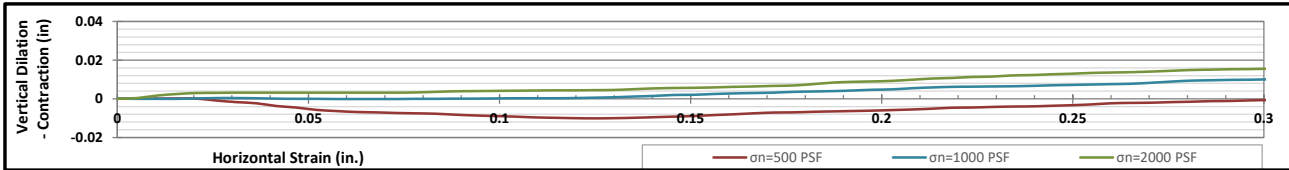
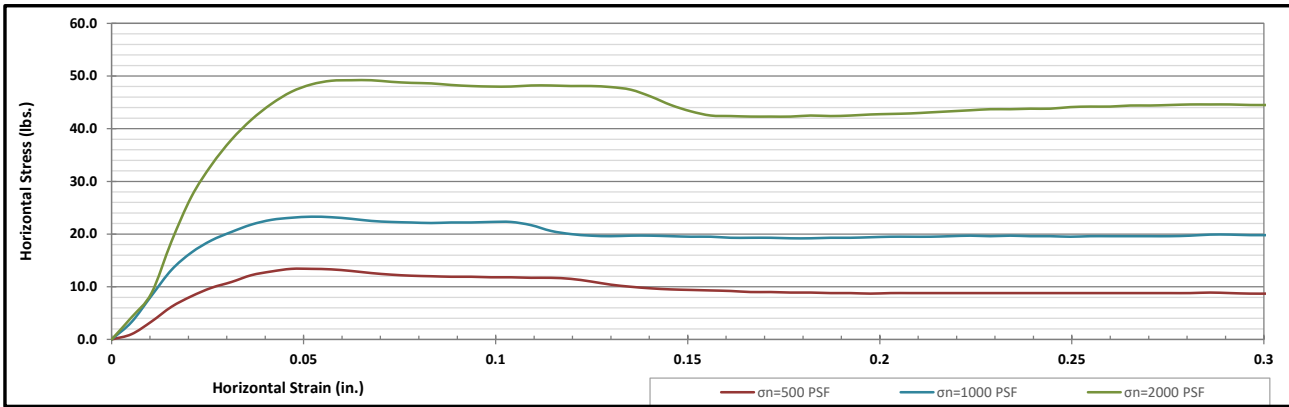
Summary of Sample Data: $\sigma_n=1000$ PSF		
Initial Moisture Content (%)	20.2	
	Initial	Post-Consolidation
Dry Density (PCF):	115.0	117.1
Void Ratio:	0.465	0.439
Porosity (%):	31.7	30.5
Degree of Saturation (%):	saturated	saturated

Summary of Sample Data: $\sigma_n=2000$ PSF		
Initial Moisture Content (%)	19.0	
	Initial	Post-Consolidation
Dry Density (PCF):	115.4	120.1
Void Ratio:	0.460	0.403
Porosity (%):	31.5	28.7
Degree of Saturation (%):	saturated	saturated

ESTIMATED STRENGTH PARAMETERS		
	PEAK	RESIDUAL
Angle of Internal Friction, $\phi$ (°):	36	32
Cohesion (PSF):	0	0



Failure Envelope Test Values:			
Normal Stress, $\sigma_n$ (PSF):	500	1000	2000
Peak Horizontal Stress, $\tau_h$ (PSF):	400	680	1440
Residual Horizontal Stress, $\tau_r$ (PSF):	250	570	1300



Corporate • 777 Chrysler Drive • Burlington, WA 98233 • Phone 360.755.1990 • Fax 360.755.1980  
 SW Region • 2118 Black Lake Blvd. S.W. • Olympia, WA 98512 • Phone 360.534.9777 • Fax 360.534.9779  
 NW Region • 805 Dupont, Suite #5 • Bellingham, WA 98225 • Phone 360.647.6061 • Fax 360.647.8111  
 Kitsap Region • 5451 N.W. Newberry Hill Road, Suite 101 • Silverdale, WA 98383 • Phone/Fax 360.698.6787

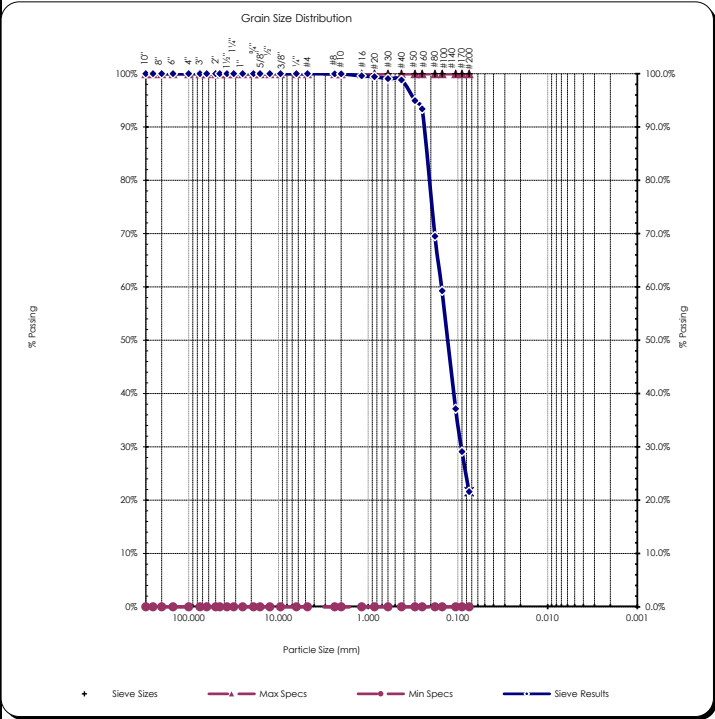
Visit our website: [www.mtc-inc.net](http://www.mtc-inc.net)

# Sieve Report

<b>Project:</b> Q.C. - Lower Duwamish Waterway <b>Project #:</b> 21B233 <b>Client:</b> Anchor QEA <b>Source:</b> LDW-GT36-6.2-9.5 ft <b>Sample#:</b> B21-1330	<b>Date Received:</b> 29-Jul-21 <b>Sampled By:</b> Client <b>Date Tested:</b> 24-Aug-21 <b>Tested By:</b> A. Eifrig	<b>Unified Soils Classification System, ASTM D-2487</b> SM, Silty Sand <b>Sample Color:</b> brown	 <b>ACCREDITED</b> Certificate #: 1366.01
---	--	--	---

<b>ASTM D2216, ASTM D2419, ASTM D4318, ASTM D5281</b>			
<b>Specifications</b> No Specs <b>Sample Meets Specs ?</b> N/A	D <sub>(5)</sub> = 0.017 mm D <sub>(10)</sub> = 0.035 mm D <sub>(15)</sub> = 0.052 mm D <sub>(30)</sub> = 0.092 mm D <sub>(50)</sub> = 0.132 mm D <sub>(60)</sub> = 0.152 mm D <sub>(90)</sub> = 0.240 mm Dust Ratio = 7/32	% Gravel = 0.0% % Sand = 78.4% % Silt & Clay = 21.6% Liquid Limit = n/a Plasticity Index = n/a Sand Equivalent = n/a Fracture %, 1 Face = n/a Fracture %, 2+ Faces = n/a	Coeff. of Curvature, C <sub>c</sub> = 1.59 Coeff. of Uniformity, C <sub>u</sub> = 4.38 Fineness Modulus = 0.47 Plastic Limit = n/a Moisture %, as sampled = 27.5% Req'd Sand Equivalent = Req'd Fracture %, 1 Face = Req'd Fracture %, 2+ Faces =

<b>ASTM C136, ASTM D6913, ASTM C117</b>					
Sieve Size		Actual Cumulative Percent Passing	Interpolated Cumulative Percent Passing	Specs Max	Specs Min
US	Metric				
12.00"	300.00		100%	100.0%	0.0%
10.00"	250.00		100%	100.0%	0.0%
8.00"	200.00		100%	100.0%	0.0%
6.00"	150.00		100%	100.0%	0.0%
4.00"	100.00		100%	100.0%	0.0%
3.00"	75.00		100%	100.0%	0.0%
2.50"	63.00		100%	100.0%	0.0%
2.00"	50.00	100%	100%	100.0%	0.0%
1.75"	45.00	100%	100%	100.0%	0.0%
1.50"	37.50	100%	100%	100.0%	0.0%
1.25"	31.50	100%	100%	100.0%	0.0%
1.00"	25.00	100%	100%	100.0%	0.0%
3/4"	19.00	100%	100%	100.0%	0.0%
5/8"	16.00	100%	100%	100.0%	0.0%
1/2"	12.50	100%	100%	100.0%	0.0%
3/8"	9.50	100%	100%	100.0%	0.0%
1/4"	6.30	100%	100%	100.0%	0.0%
#4	4.75	100%	100%	100.0%	0.0%
#8	2.36	100%	100%	100.0%	0.0%
#10	2.00	100%	100%	100.0%	0.0%
#16	1.18	100%	100%	100.0%	0.0%
#20	0.850	99%	99%	100.0%	0.0%
#30	0.600	99%	99%	100.0%	0.0%
#40	0.425	99%	99%	100.0%	0.0%
#50	0.300	95%	95%	100.0%	0.0%
#60	0.250	93%	93%	100.0%	0.0%
#80	0.180	70%	70%	100.0%	0.0%
#100	0.150	59%	59%	100.0%	0.0%
#140	0.106	37%	37%	100.0%	0.0%
#170	0.090	29%	29%	100.0%	0.0%
#200	0.075	21.6%	21.6%	100.0%	0.0%



Copyright Spears Engineering & Technical Services PS, 1996-98

All results apply only to actual locations and materials tested. As a mutual protection to clients, the public and ourselves, all reports are submitted as the confidential property of clients, and authorization for publication of statements, conclusions or extracts from or regarding our reports is reserved pending our written approval.

**Comments:** \_\_\_\_\_

**Reviewed by:**   
 \_\_\_\_\_  
 Meghan Blodgett-Carrillo

# Sieve Report

<b>Project:</b> Q.C. - Lower Duwamish Waterway <b>Project #:</b> 21B233 <b>Client:</b> Anchor QEA <b>Source:</b> LDW-GT36-11.7-32 ft <b>Sample#:</b> B21-1332	<b>Date Received:</b> 29-Jul-21 <b>Sampled By:</b> Client <b>Date Tested:</b> 24-Aug-21 <b>Tested By:</b> A. Eifrig	<b>Unified Soils Classification System, ASTM D-2487</b> SP-SM, Poorly graded Sand with Silt <b>Sample Color:</b> brown	 <b>ACCREDITED</b> Certificate #: 1366.01
---	--	---	---

**ASTM D2216, ASTM D2419, ASTM D4318, ASTM D5281**

**Specifications**

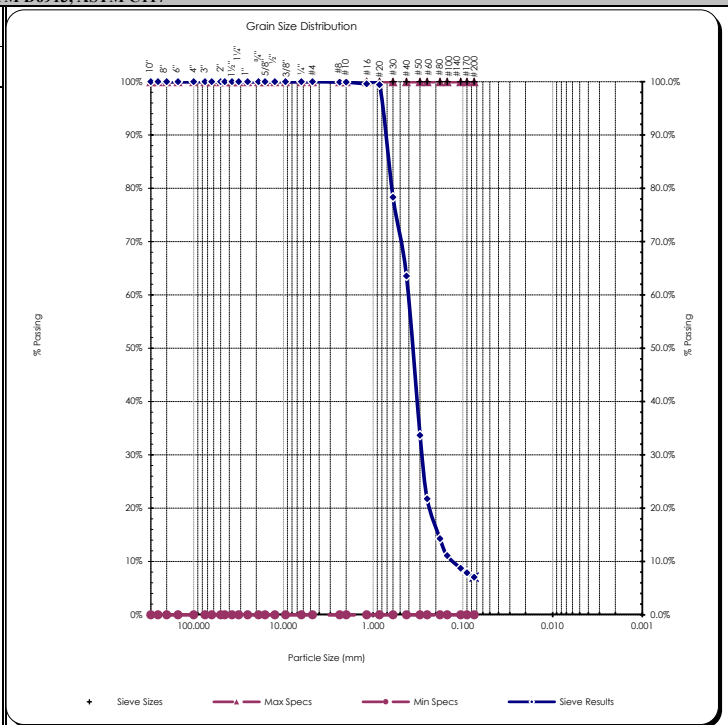
No Specs

Sample Meets Specs ? **N/A**

D <sub>(5)</sub> = 0.053 mm	% Gravel = 0.0%	Coeff. of Curvature, C <sub>c</sub> = 1.53
D <sub>(10)</sub> = 0.129 mm	% Sand = 92.9%	Coeff. of Uniformity, C <sub>u</sub> = 3.18
D <sub>(15)</sub> = 0.186 mm	% Silt & Clay = 7.1%	Fineness Modulus = 1.77
D <sub>(30)</sub> = 0.285 mm	Liquid Limit = n/a	Plastic Limit = n/a
D <sub>(50)</sub> = 0.368 mm	Plasticity Index = n/a	Moisture %, as sampled = 15.7%
D <sub>(60)</sub> = 0.410 mm	Sand Equivalent = n/a	Req'd Sand Equivalent =
D <sub>(90)</sub> = 0.738 mm	Fracture %, 1 Face = n/a	Req'd Fracture %, 1 Face =
Dust Ratio = 1/9	Fracture %, 2+ Faces = n/a	Req'd Fracture %, 2+ Faces =

**ASTM C136, ASTM D6913, ASTM C117**

Sieve Size		Actual Cumulative Percent Passing	Interpolated Cumulative Percent Passing	Specs Max	Specs Min
US	Metric				
12.00"	300.00		100%	100.0%	0.0%
10.00"	250.00		100%	100.0%	0.0%
8.00"	200.00		100%	100.0%	0.0%
6.00"	150.00		100%	100.0%	0.0%
4.00"	100.00		100%	100.0%	0.0%
3.00"	75.00		100%	100.0%	0.0%
2.50"	63.00		100%	100.0%	0.0%
2.00"	50.00	100%	100%	100.0%	0.0%
1.75"	45.00		100%	100.0%	0.0%
1.50"	37.50		100%	100.0%	0.0%
1.25"	31.50		100%	100.0%	0.0%
1.00"	25.00	100%	100%	100.0%	0.0%
3/4"	19.00	100%	100%	100.0%	0.0%
5/8"	16.00		100%	100.0%	0.0%
1/2"	12.50	100%	100%	100.0%	0.0%
3/8"	9.50	100%	100%	100.0%	0.0%
1/4"	6.30		100%	100.0%	0.0%
#4	4.75	100%	100%	100.0%	0.0%
#8	2.36		100%	100.0%	0.0%
#10	2.00	100%	100%	100.0%	0.0%
#16	1.18		100%	100.0%	0.0%
#20	0.850	99%	99%	100.0%	0.0%
#30	0.600		78%	100.0%	0.0%
#40	0.425	64%	64%	100.0%	0.0%
#50	0.300		34%	100.0%	0.0%
#60	0.250	22%	22%	100.0%	0.0%
#80	0.180		14%	100.0%	0.0%
#100	0.150	11%	11%	100.0%	0.0%
#140	0.106		9%	100.0%	0.0%
#170	0.090		8%	100.0%	0.0%
#200	0.075	7.1%	7.1%	100.0%	0.0%



Copyright Spears Engineering & Technical Services PS, 1996-98

All results apply only to actual locations and materials tested. As a mutual protection to clients, the public and ourselves, all reports are submitted as the confidential property of clients, and authorization for publication of statements, conclusions or extracts from or regarding our reports is reserved pending our written approval.

**Comments:**


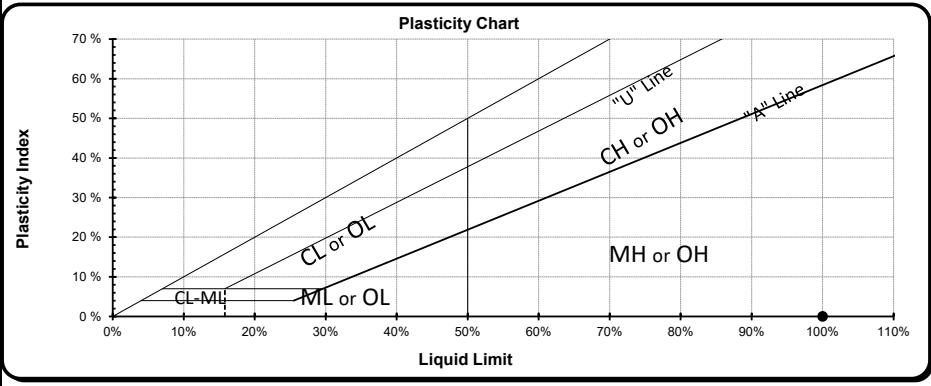
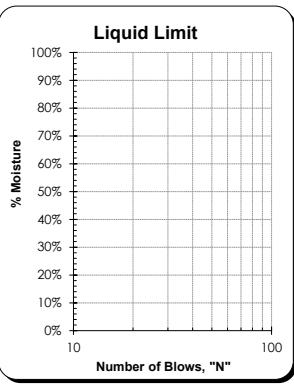
Reviewed by:   
 Meghan Blodgett-Carrillo

# Materials Testing & Consulting, Inc.

Geotechnical Engineering • Special Inspections • Materials Testing • Environmental Consulting



## ASTM D4318 - Liquid Limit, Plastic Limit and Plasticity Index of Soils

<b>Project:</b> Q.C. - Lower Duwamish Waterway <b>Project #:</b> 21B233 <b>Client:</b> Anchor QEA <b>Source:</b> LDW-GT36-32-34.7 ft <b>Sample #:</b> B21-1333	<b>Date Received:</b> 29-Jul-21 <b>Sampled By:</b> Client <b>Date Tested:</b> 25-Aug-21 <b>Tested By:</b> C. Kriss	<b>Visual Identification</b> Sand with Silt <b>Sample Color</b> brown				
<b>Liquid Limit Determination</b>						
#1                      #2                      #3                      #4                      #5                      #6						
Weight of Wet Soils + Pan:	Liquid Limit cannot be established					
Weight of Dry Soils + Pan:	Liquid Limit cannot be established					
Weight of Pan:	Liquid Limit cannot be established					
Weight of Dry Soils:	Liquid Limit cannot be established					
Weight of Moisture:	Liquid Limit cannot be established					
% Moisture:	Liquid Limit cannot be established					
Number of Blows:	Liquid Limit cannot be established					
<b>Liquid Limit @ 25 Blows:</b> N/A <b>Plastic Limit:</b> N/A <b>Plasticity Index, I<sub>p</sub>:</b> N/A						
<b>Plastic Limit Determination</b>						
#1                      #2                      #3                      #4                      #5                      #6						
Weight of Wet Soils + Pan:	Plastic Limit cannot be determined					
Weight of Dry Soils + Pan:	Plastic Limit cannot be determined					
Weight of Pan:	Plastic Limit cannot be determined					
Weight of Dry Soils:	Plastic Limit cannot be determined					
Weight of Moisture:	Plastic Limit cannot be determined					
% Moisture:	Plastic Limit cannot be determined					
						
<div style="display: flex; justify-content: space-between;"> <div style="width: 60%;">  </div> <div style="width: 35%;">  </div> </div>						

Copyright Spears Engineering & Technical Services PS, 1996-98  
 All results apply only to actual locations and materials tested. As a mutual protection to clients, the public and ourselves, all reports are submitted as the confidential property of clients, and authorization for publication of statements, conclusions or extracts from or regarding our reports is reserved pending our written approval.

**Comments:** Liquid limit cannot be established as the material displays rapid dilation upon spreading into the cup. At lower moistures the material does not spread into the liquid limit device without tearing the soil cake. Plastic limit cannot be determined as the material does not roll down to 1/8" threads before cracking or crumbling. Non-plastic.

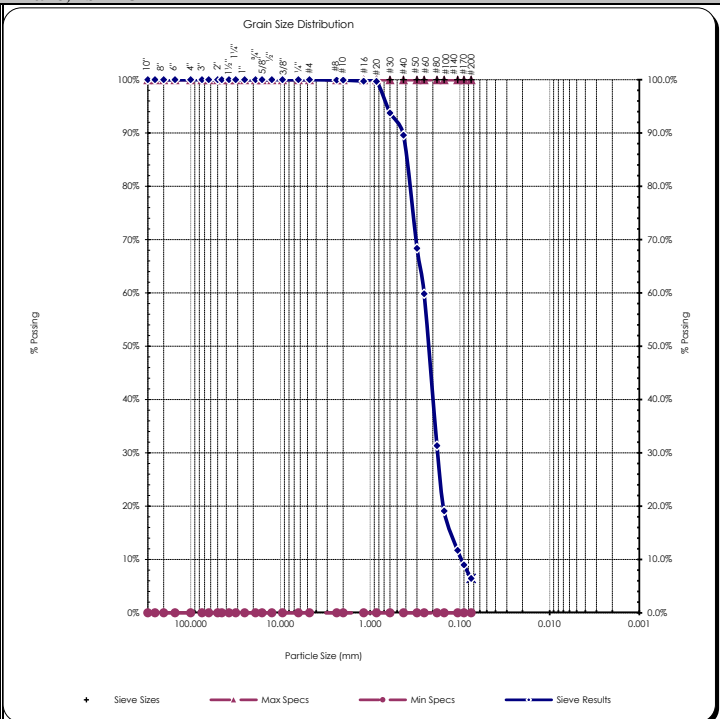
Reviewed by:   
 Meghan Blodgett-Carrillo

# Sieve Report

<b>Project:</b> Q.C. - Lower Duwamish Waterway <b>Project #:</b> 21B233 <b>Client:</b> Anchor QEA <b>Source:</b> LDW-GT36-34.7-50 ft <b>Sample#:</b> B21-1334	<b>Date Received:</b> 29-Jul-21 <b>Sampled By:</b> Client <b>Date Tested:</b> 24-Aug-21 <b>Tested By:</b> A. Eifrig	<b>Unified Soils Classification System, ASTM D-2487</b> SP-SM, Poorly graded Sand with Silt <b>Sample Color:</b> grayish-brown	 <b>ACCREDITED</b> Certificate #: 1366.01
---	--	---	---

<b>ASTM D2216, ASTM D2419, ASTM D4318, ASTM D5281</b>			
<b>Specifications</b> No Specs <b>Sample Meets Specs ?</b> N/A	D <sub>(5)</sub> = 0.058 mm D <sub>(10)</sub> = 0.096 mm D <sub>(15)</sub> = 0.126 mm D <sub>(30)</sub> = 0.177 mm D <sub>(50)</sub> = 0.226 mm D <sub>(60)</sub> = 0.251 mm D <sub>(90)</sub> = 0.441 mm Dust Ratio = 6/83	% Gravel = 0.0% % Sand = 93.5% % Silt & Clay = 6.5% Liquid Limit = n/a Plasticity Index = n/a Sand Equivalent = n/a Fracture %, 1 Face = n/a Fracture %, 2+ Faces = n/a	Coeff. of Curvature, C <sub>c</sub> = 1.30 Coeff. of Uniformity, C <sub>u</sub> = 2.62 Fineness Modulus = 1.19 Plastic Limit = n/a Moisture %, as sampled = 23.7% Req'd Sand Equivalent = Req'd Fracture %, 1 Face = Req'd Fracture %, 2+ Faces =

<b>ASTM C136, ASTM D6913, ASTM C117</b>					
Sieve Size		Actual Cumulative Percent Passing	Interpolated Cumulative Percent Passing	Specs Max	Specs Min
US	Metric				
12.00"	300.00		100%	100.0%	0.0%
10.00"	250.00		100%	100.0%	0.0%
8.00"	200.00		100%	100.0%	0.0%
6.00"	150.00		100%	100.0%	0.0%
4.00"	100.00		100%	100.0%	0.0%
3.00"	75.00		100%	100.0%	0.0%
2.50"	63.00		100%	100.0%	0.0%
2.00"	50.00	100%	100%	100.0%	0.0%
1.75"	45.00	100%	100%	100.0%	0.0%
1.50"	37.50	100%	100%	100.0%	0.0%
1.25"	31.50	100%	100%	100.0%	0.0%
1.00"	25.00	100%	100%	100.0%	0.0%
3/4"	19.00	100%	100%	100.0%	0.0%
5/8"	16.00	100%	100%	100.0%	0.0%
1/2"	12.50	100%	100%	100.0%	0.0%
3/8"	9.50	100%	100%	100.0%	0.0%
1/4"	6.30	100%	100%	100.0%	0.0%
#4	4.75	100%	100%	100.0%	0.0%
#8	2.36	100%	100%	100.0%	0.0%
#10	2.00	100%	100%	100.0%	0.0%
#16	1.18	100%	100%	100.0%	0.0%
#20	0.850	100%	100%	100.0%	0.0%
#30	0.600	94%	94%	100.0%	0.0%
#40	0.425	90%	90%	100.0%	0.0%
#50	0.300	68%	68%	100.0%	0.0%
#60	0.250	60%	60%	100.0%	0.0%
#80	0.180	31%	31%	100.0%	0.0%
#100	0.150	19%	19%	100.0%	0.0%
#140	0.106	12%	12%	100.0%	0.0%
#170	0.090	9%	9%	100.0%	0.0%
#200	0.075	6.5%	6.5%	100.0%	0.0%



Copyright Spears Engineering & Technical Services PS, 1996-98  
 All results apply only to actual locations and materials tested. As a mutual protection to clients, the public and ourselves, all reports are submitted as the confidential property of clients, and authorization for publication of statements, conclusions or extracts from or regarding our reports is reserved pending our written approval.

**Comments:** \_\_\_\_\_

Reviewed by:   
 Meghan Blodgett-Carrillo

# Materials Testing & Consulting, Inc.

Geotechnical Engineering • Special Inspections • Materials Testing • Environmental Consulting



## ASTM D4318 - Liquid Limit, Plastic Limit and Plasticity Index of Soils

<b>Project:</b> Q.C. - Lower Duwamish Waterway <b>Project #:</b> 21B233 <b>Client:</b> Anchor QEA <b>Source:</b> LDW-GT-36-50.5-61.5 ft <b>Sample #:</b> B21-1335	<b>Date Received:</b> 29-Jul-21 <b>Sampled By:</b> Client <b>Date Tested:</b> 25-Aug-21 <b>Tested By:</b> C. Kriss	<b>Visual Identification</b> Silty Clay <b>Sample Color</b> brown
---	---	--

Liquid Limit Determination						
	#1	#2	#3	#4	#5	#6
Weight of Wet Soils + Pan:	29.50	30.28	27.77			
Weight of Dry Soils + Pan:	26.95	27.50	24.20			
Weight of Pan:	19.61	19.98	14.98			
Weight of Dry Soils:	7.34	7.52	9.22			
Weight of Moisture:	2.55	2.78	3.57			
% Moisture:	34.7 %	37.0 %	38.7 %			
Number of Blows:	30	21	11			

Plastic Limit Determination						
	#1	#2	#3	#4	#5	#6
Weight of Wet Soils + Pan:	34.74	35.86				
Weight of Dry Soils + Pan:	33.48	34.32				
Weight of Pan:	28.53	28.24				
Weight of Dry Soils:	4.95	6.08				
Weight of Moisture:	1.26	1.54				
% Moisture:	25.5 %	25.3 %				

<p style="text-align: center;"><b>Plasticity Chart</b></p> <p style="text-align: center;">Copyright Spears Engineering &amp; Technical Services PS, 1996-98</p>	<p style="text-align: center;"><b>Liquid Limit</b></p>
---	--

Liquid Limit @ 25 Blows: 36 %  
 Plastic Limit: 25 %  
 Plasticity Index, I<sub>p</sub>: 11 %



All results apply only to actual locations and materials tested. As a mutual protection to clients, the public and ourselves, all reports are submitted as the confidential property of clients, and authorization for publication of statements, conclusions or extracts from or regarding our reports is reserved pending our written approval.

**Comments:** \_\_\_\_\_

Reviewed by: *Meghan Blodgett-Carrillo*  
 Meghan Blodgett-Carrillo



**Client:** Anchor QEA  
**Address:** 21328 2nd Drive SE  
Bothell, WA 98021  
**Attn:** Garrett Timm  
**Revised on:** \_\_\_\_\_

**Date:** September 29, 2021  
**Project:** Q.C. - Lower Duwamish Waterway  
**Project #:** 21B233  
**Sample #:** B21-1447 - 1466  
**Date sampled:** 7-8-21 & 7-9-21

As requested MTC, Inc. has performed the following test(s) on the sample referenced above. The testing was performed in accordance with current applicable AASHTO or ASTM standards as indicated below. The results obtained in our laboratory were as follows below or on the attached pages:

	Test(s) Performed:	Test Results		Test(s) Performed:	Test Results
X	Sieve Analysis	Please See Attached Reports		Sulfate Soundness	
	Proctor			Bulk Density & Voids	
	Sand Equivalent			WSDOT Degradation	
	Fracture Count			LA Abrasion	
X	Moisture Content	Please See Attached Report	X	Direct Shear	Please See Attached Reports
	Specific Gravity, Coarse		X	Specific Gravity, Soils	Please See Attached Reports
	Specific Gravity, Fine				
X	Hydrometer Analysis	Please See Attached Reports			
X	Atterberg Limits	Please See Attached Reports			

If you have any questions concerning the test results, the procedures used, or if we can be of any further assistance please call on us at the number below.

Respectfully Submitted,  
 Meghan Blodgett-Carrillo  
 WABO Supervising Laboratory Technician





## Moisture Content - ASTM C566, ASTM D2216


**Project:** Q.C. - Lower Duwamish Waterway  
**Project #:** 21B233  
**Date Received:** July 29, 2021  
**Date Tested:** August 31, 2021

**Client:** Anchor QEA  
**Sampled by:** Client  
**Tested by:** A. Eifrig

Sample #	Location	Tare	Wet + Tare	Dry + Tare	Wgt. Of Moisture	Wgt. Of Soil	% Moisture
B21-1447	LDW21-GT21-GB-31-32.5 ft	222.3	700.9	590.1	110.8	367.8	30.1%
B21-1448	LDW21-GT12-GB-0-1.5 ft	208.8	636.4	466.8	169.6	258.0	65.7%
B21-1449	LDW21-GT12-GB-0-12 ft	224.0	851.3	609.9	241.4	385.9	62.6%
B21-1450	LDW21-GT12-GB-12-13.5 ft	233.8	567.3	458.5	108.8	224.7	48.4%
B21-1451	LDW21-GT12-GB-18-22 ft	222.9	780.0	643.4	136.6	420.5	32.5%
B21-1452	LDW21-GT12-GB-22-23.5 ft	229.4	723.2	606.3	116.9	376.9	31.0%
B21-1453	LDW21-GT11-GB-0-1.5 ft	221.8	617.6	440.0	177.6	218.2	81.4%
B21-1454	LDW21-GT11-GB-0-8.5 ft	233.8	686.2	473.2	213.0	239.4	89.0%
B21-1455	LDW21-GT11-GB-8.5-10 ft	224.8	616.6	455.4	161.2	230.6	69.9%
B21-1456	LDW21-GT11-GB-8.5-16.7 ft	182.3	495.3	374.9	120.4	192.6	62.5%
B21-1457	LDW21-GT11-GB-16.7-18.5 ft	186.7	993.2	821.5	171.7	634.8	27.0%
B21-1458	LDW21-GT11-GB-18.5-20 ft	220.1	643.5	566.8	76.7	346.7	22.1%
B21-1459	LDW21-GT9-GB-0-1.5 ft	221.4	388.1	331.3	56.8	109.9	51.7%
B21-1460	LDW21-GT9-GB-10-11.5 ft	225.6	534.4	429.8	104.6	204.2	51.2%
B21-1461	LDW21-GT9-GB- <del>16-20 ft</del>	225.7	665.4	521.2	144.2	295.5	48.8%
B21-1462	LDW21-GT9-GB-20-21.5 ft	235.5	299.4	285.9	13.5	50.4	26.8%
B21-1463	LDW21-GT7-GB-0-1.5 ft	301.1	545.2	480.4	64.8	179.3	36.1%
B21-1464	LDW21-GT7-GB-0-5.7 ft	182.9	988.2	806.6	181.6	623.7	29.1%
B21-1465	LDW21-GT7-GB-8.5-10 ft	217.2	591.3	504.5	86.8	287.3	30.2%
B21-1466	LDW21-GT7-GB-8.5-18.5 ft	233.4	693.2	578.2	115.0	344.8	33.4%

All results apply only to actual locations and materials tested. As a mutual protection to clients, the public and ourselves, all reports are submitted as the confidential property of clients, and authorization for publication of statements, conclusions or extracts from or regarding our reports is reserved pending our written approval.

Name correction:  
LDW21-GT9-GB-10-20

Reviewed by:   
 Meghan Blodgett-Carrillo




## Moisture Content - ASTM D854

Project: Q.C. - Lower Duwamish Waterway  
 Project #: 21B233  
 Date Received: July 29, 2021  
 Date Tested: August 31, 2021

Client: Anchor QEA  
 Sampled by: Client  
 Tested by: A. Eifrig

Sample #	Location	Tare	Dry Soil + Tare	Mass of Dry Soil	Pycno ID	Mass of Pycno	Volume of Pycno	Density of Water @ Tx	Mass of Pycno filled w/ water & soils	Mass of Pycno filled w/ water	Temp. of Water, 0.1 *C	SpG of Soils	Temp. Correction Factor	Corrected SpG
B21-1449	LDW21-GT12-GB-0-12 ft	493.02	545.53	52.5	TSA-012	180.4	499.5	0.99749	742.00	709.46	23.2	2.6294442	0.99929	2.6275773
B21-1451	LDW21-GT12-GB-18-22 ft	497.56	597.70	100.1	TSA-023	163.9	498.7	0.99749	723.96	661.41	23.2	2.6641366	0.99929	2.6622451
B21-1459	LDW21-GT9-GB-0-1.5 ft	601.92	676.89	75.0	TSA-015	187.6	499.5	0.99749	732.66	685.85	23.2	2.6626339	0.99929	2.6607434
B21-1461	LDW21-GT7-GB-0-5.7 ft	502.15	601.95	99.8	TSA-021	183.4	499.4	0.99749	744.55	681.58	23.2	2.7100064	0.99929	2.7080823

All results apply only to actual locations and materials tested. As a mutual protection to clients, the public and ourselves, all reports are submitted as the confidential property of clients, and authorization for publication of statements, conclusions or extracts from or regarding our reports is reserved pending our written approval.

Reviewed by:   
 Meghan Blodgett-Carrillo

## ASTM D4318 - Liquid Limit, Plastic Limit and Plasticity Index of Soils

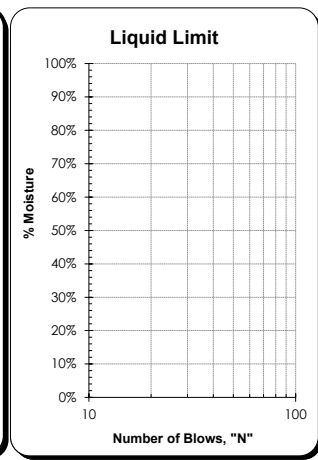
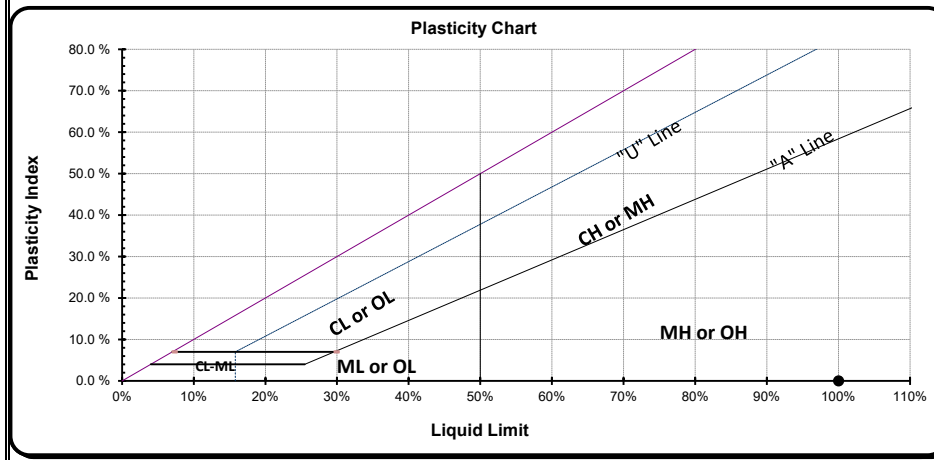
<b>Project:</b> Q.C. - Lower Duwamish Waterway <b>Project #:</b> 21B233 <b>Client:</b> Anchor QEA <b>Source:</b> LDW21-GT12-GB-0-12 ft <b>Sample #:</b> B21-1449	<b>Date Received:</b> 29-Jul-21 <b>Sampled By:</b> Client <b>Date Tested:</b> 31-Aug-21 <b>Tested By:</b> C. Kriss	<b>Visual Identification</b> Clayey Silt with Sand <b>Sample Color</b> brown
--	---	---

Liquid Limit Determination						
	#1	#2	#3	#4	#5	#6
Weight of Wet Soils + Pan:	Liquid limit cannot be established					
Weight of Dry Soils + Pan:						
Weight of Pan:						
Weight of Dry Soils:						
Weight of Moisture:						
% Moisture:						
Number of Blows:						



**Liquid Limit @ 25 Blows:** N/A  
**Plastic Limit:** N/A  
**Plasticity Index, I<sub>p</sub>:** N/A

Plastic Limit Determination						
	#1	#2	#3	#4	#5	#6
Weight of Wet Soils + Pan:	Plastic limit cannot be determined					
Weight of Dry Soils + Pan:						
Weight of Pan:						
Weight of Dry Soils:						
Weight of Moisture:						
% Moisture:						



All results apply only to actual locations and materials tested. As a mutual protection to clients, the public and ourselves, all reports are submitted as the confidential property of clients, and authorization for publication of statements, conclusions or extracts from or regarding our reports is reserved pending our written approval.

**Comments:** Liquid limit cannot be established as the material displays rapid dilation upon spreading into the cup. At lower moistures the material does not spread into the cup without tearing the soil cake. Plastic limit cannot be determined as the material does not roll down to 1/8" threads before cracking or crumbling. Non-plastic.

Reviewed by:   
 \_\_\_\_\_  
 Meghan Blodgett-Carrillo



# Sieve Report

<b>Project:</b> Q.C. - Lower Duwamish Waterway <b>Project #:</b> 21B233 <b>Client:</b> Anchor QEA <b>Source:</b> LDW21-GT12-GB-18-22 ft <b>Sample#:</b> B21-1451	<b>Date Received:</b> 29-Jul-21 <b>Sampled By:</b> Client <b>Date Tested:</b> 31-Aug-21 <b>Tested By:</b> C. Kriss	<b>Unified Soil Classification System, ASTM-2487</b> SM, Silty Sand <b>Sample Color:</b> brown	 Certificate #: 1366.01
--	---	---	----------------------------

ASTM D2216, ASTM D2419, ASTM D4318, ASTM D5281

**Specifications**

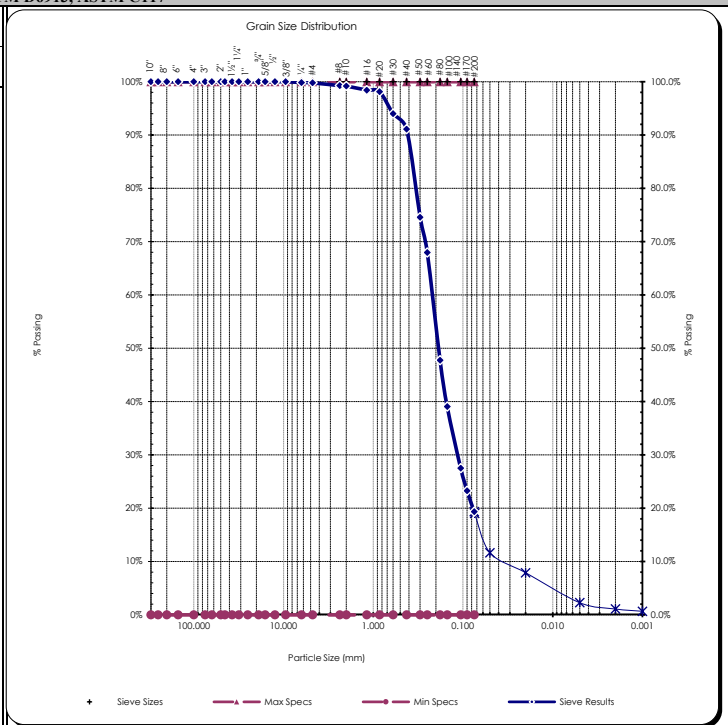
No Specs

Sample Meets Specs ? N/A

D <sub>(5)</sub> = 0.010 mm	% Gravel = 0.2%	Coeff. of Curvature, C <sub>c</sub> = 1.73
D <sub>(10)</sub> = 0.035 mm	% Sand = 80.4%	Coeff. of Uniformity, C <sub>u</sub> = 6.41
D <sub>(15)</sub> = 0.062 mm	% Silt & Clay = 19.3%	Fineness Modulus = 0.95
D <sub>(30)</sub> = 0.115 mm	Liquid Limit = 0.0%	Plastic Limit = 0.0%
D <sub>(50)</sub> = 0.188 mm	Plasticity Index = 0.0%	Moisture %, as sampled = 32.5%
D <sub>(60)</sub> = 0.222 mm	Sand Equivalent = n/a	Req'd Sand Equivalent =
D <sub>(90)</sub> = 0.417 mm	Fracture %, 1 Face = n/a	Req'd Fracture %, 1 Face =
Dust Ratio = 7/33	Fracture %, 2+ Faces = n/a	Req'd Fracture %, 2+ Faces =

ASTM C136, ASTM D6913, ASTM C117

Sieve Size		Actual Cumulative Percent Passing	Interpolated Cumulative Percent Passing	Specs Max	Specs Min
US	Metric				
12.00"	300.00		100%	100.0%	0.0%
10.00"	250.00		100%	100.0%	0.0%
8.00"	200.00		100%	100.0%	0.0%
6.00"	150.00		100%	100.0%	0.0%
4.00"	100.00		100%	100.0%	0.0%
3.00"	75.00		100%	100.0%	0.0%
2.50"	63.00		100%	100.0%	0.0%
2.00"	50.00	100%	100%	100.0%	0.0%
1.75"	45.00		100%	100.0%	0.0%
1.50"	37.50		100%	100.0%	0.0%
1.25"	31.50		100%	100.0%	0.0%
1.00"	25.00	100%	100%	100.0%	0.0%
3/4"	19.00	100%	100%	100.0%	0.0%
5/8"	16.00		100%	100.0%	0.0%
1/2"	12.50	100%	100%	100.0%	0.0%
3/8"	9.50	100%	100%	100.0%	0.0%
1/4"	6.30		100%	100.0%	0.0%
#4	4.75	100%	100%	100.0%	0.0%
#8	2.36		99%	100.0%	0.0%
#10	2.00	99%	99%	100.0%	0.0%
#16	1.18		98%	100.0%	0.0%
#20	0.850	98%	98%	100.0%	0.0%
#30	0.600		94%	100.0%	0.0%
#40	0.425	91%	91%	100.0%	0.0%
#50	0.300		75%	100.0%	0.0%
#60	0.250	68%	68%	100.0%	0.0%
#80	0.180		48%	100.0%	0.0%
#100	0.150	39%	39%	100.0%	0.0%
#140	0.106		28%	100.0%	0.0%
#170	0.090		23%	100.0%	0.0%
#200	0.075	19.3%	19.3%	100.0%	0.0%



Copyright Spears Engineering & Technical Services PS, 1996-98


All results apply only to actual locations and materials tested. As a mutual protection to clients, the public and ourselves, all reports are submitted as the confidential property of clients, and authorization for publication of statements, conclusions or extracts from or regarding our reports is reserved pending our written approval.

Comments:

Reviewed by: *Meghan Blodgett-Carrillo*  
 Meghan Blodgett-Carrillo



## Hydrometer Report


<b>Project:</b> Q.C. - Lower Duwamish Waterway <b>Project #:</b> 21B233 <b>Client:</b> Anchor QEA <b>Source:</b> LDW21-GT12-GB-18-22 ft <b>Sample#:</b> B21-1451	<b>Date Received:</b> 29-Jul-21 <b>Sampled By:</b> Client <b>Date Tested:</b> 31-Aug-21 <b>Tested By:</b> C. Kriss	<b>Unified Soil Classification System, ASTM-2487</b> SM, Silty Sand <b>Sample Color</b> brown																																																																					
<b>ASTM D7928, HYDROMETER ANALYSIS</b>		<b>ASTM D6913</b>																																																																					
<b>Sp Gr :</b> 2.66 <b>Sample Weight:</b> 102.98 grams <b>Hydroscopic Moist.:</b> 1.38% <b>Adj. Sample Wgt :</b> 101.58 grams	 <b>ACCREDITED</b> Certificate #: 1366.01	<b>Sieve Analysis</b> <b>Grain Size Distribution</b> <table border="1" style="width: 100%; border-collapse: collapse; margin-top: 5px;"> <thead> <tr> <th>Sieve Size</th> <th>Percent Passing</th> <th>Soils Particle Diameter</th> </tr> </thead> <tbody> <tr><td>3.0"</td><td>100%</td><td>75.000 mm</td></tr> <tr><td>2.0"</td><td>100%</td><td>50.000 mm</td></tr> <tr><td>1.5"</td><td>100%</td><td>37.500 mm</td></tr> <tr><td>1.25"</td><td>100%</td><td>31.500 mm</td></tr> <tr><td>1.0"</td><td>100%</td><td>25.000 mm</td></tr> <tr><td>3/4"</td><td>100%</td><td>19.000 mm</td></tr> <tr><td>5/8"</td><td>100%</td><td>16.000 mm</td></tr> <tr><td>1/2"</td><td>100%</td><td>12.500 mm</td></tr> <tr><td>3/8"</td><td>100%</td><td>9.500 mm</td></tr> <tr><td>1/4"</td><td>100%</td><td>6.300 mm</td></tr> <tr><td>#4</td><td>100%</td><td>4.750 mm</td></tr> <tr><td>#10</td><td>99%</td><td>2.000 mm</td></tr> <tr><td>#20</td><td>98%</td><td>0.850 mm</td></tr> <tr><td>#40</td><td>91%</td><td>0.425 mm</td></tr> <tr><td>#100</td><td>39%</td><td>0.150 mm</td></tr> <tr><td>#200</td><td>19.3%</td><td>0.075 mm</td></tr> <tr><td><b>Silts</b></td><td>19.0%</td><td>0.074 mm</td></tr> <tr><td></td><td>11.7%</td><td>0.050 mm</td></tr> <tr><td></td><td>7.9%</td><td>0.020 mm</td></tr> <tr><td><b>Clays</b></td><td>2.3%</td><td>0.005 mm</td></tr> <tr><td></td><td>1.1%</td><td>0.002 mm</td></tr> <tr><td><b>Colloids</b></td><td>0.7%</td><td>0.001 mm</td></tr> </tbody> </table>	Sieve Size	Percent Passing	Soils Particle Diameter	3.0"	100%	75.000 mm	2.0"	100%	50.000 mm	1.5"	100%	37.500 mm	1.25"	100%	31.500 mm	1.0"	100%	25.000 mm	3/4"	100%	19.000 mm	5/8"	100%	16.000 mm	1/2"	100%	12.500 mm	3/8"	100%	9.500 mm	1/4"	100%	6.300 mm	#4	100%	4.750 mm	#10	99%	2.000 mm	#20	98%	0.850 mm	#40	91%	0.425 mm	#100	39%	0.150 mm	#200	19.3%	0.075 mm	<b>Silts</b>	19.0%	0.074 mm		11.7%	0.050 mm		7.9%	0.020 mm	<b>Clays</b>	2.3%	0.005 mm		1.1%	0.002 mm	<b>Colloids</b>	0.7%	0.001 mm
Sieve Size	Percent Passing	Soils Particle Diameter																																																																					
3.0"	100%	75.000 mm																																																																					
2.0"	100%	50.000 mm																																																																					
1.5"	100%	37.500 mm																																																																					
1.25"	100%	31.500 mm																																																																					
1.0"	100%	25.000 mm																																																																					
3/4"	100%	19.000 mm																																																																					
5/8"	100%	16.000 mm																																																																					
1/2"	100%	12.500 mm																																																																					
3/8"	100%	9.500 mm																																																																					
1/4"	100%	6.300 mm																																																																					
#4	100%	4.750 mm																																																																					
#10	99%	2.000 mm																																																																					
#20	98%	0.850 mm																																																																					
#40	91%	0.425 mm																																																																					
#100	39%	0.150 mm																																																																					
#200	19.3%	0.075 mm																																																																					
<b>Silts</b>	19.0%	0.074 mm																																																																					
	11.7%	0.050 mm																																																																					
	7.9%	0.020 mm																																																																					
<b>Clays</b>	2.3%	0.005 mm																																																																					
	1.1%	0.002 mm																																																																					
<b>Colloids</b>	0.7%	0.001 mm																																																																					
<table border="1" style="width: 100%; border-collapse: collapse; margin-top: 10px;"> <thead> <tr> <th>Hydrometer Reading Minutes</th> <th>Corrected Reading</th> <th>Percent Passing</th> <th>Soils Particle Diameter</th> </tr> </thead> <tbody> <tr><td>1</td><td>12</td><td>11.7%</td><td>0.0516 mm</td></tr> <tr><td>2</td><td>10.5</td><td>10.3%</td><td>0.0370 mm</td></tr> <tr><td>5</td><td>9</td><td>8.8%</td><td>0.0235 mm</td></tr> <tr><td>15</td><td>6.5</td><td>6.3%</td><td>0.0138 mm</td></tr> <tr><td>30</td><td>5</td><td>4.9%</td><td>0.0098 mm</td></tr> <tr><td>60</td><td>3.5</td><td>3.4%</td><td>0.0070 mm</td></tr> <tr><td>240</td><td>1.5</td><td>1.5%</td><td>0.0035 mm</td></tr> <tr><td>1440</td><td>1</td><td>1.0%</td><td>0.0014 mm</td></tr> </tbody> </table> <table style="width: 100%;"> <tr> <td style="width: 50%;"> <b>% Gravel:</b> 0.2%  <b>% Sand:</b> 80.4%  <b>% Silt:</b> 17.1%  <b>% Clay:</b> 2.3%         </td> <td style="width: 50%; text-align: right;"> <b>Liquid Limit:</b> 0.0 %  <b>Plastic Limit:</b> 0.0 %  <b>Plasticity Index:</b> 0.0 %         </td> </tr> </table>	Hydrometer Reading Minutes	Corrected Reading	Percent Passing	Soils Particle Diameter	1	12	11.7%	0.0516 mm	2	10.5	10.3%	0.0370 mm	5	9	8.8%	0.0235 mm	15	6.5	6.3%	0.0138 mm	30	5	4.9%	0.0098 mm	60	3.5	3.4%	0.0070 mm	240	1.5	1.5%	0.0035 mm	1440	1	1.0%	0.0014 mm	<b>% Gravel:</b> 0.2% <b>% Sand:</b> 80.4% <b>% Silt:</b> 17.1% <b>% Clay:</b> 2.3%	<b>Liquid Limit:</b> 0.0 % <b>Plastic Limit:</b> 0.0 % <b>Plasticity Index:</b> 0.0 %																																	
Hydrometer Reading Minutes	Corrected Reading	Percent Passing	Soils Particle Diameter																																																																				
1	12	11.7%	0.0516 mm																																																																				
2	10.5	10.3%	0.0370 mm																																																																				
5	9	8.8%	0.0235 mm																																																																				
15	6.5	6.3%	0.0138 mm																																																																				
30	5	4.9%	0.0098 mm																																																																				
60	3.5	3.4%	0.0070 mm																																																																				
240	1.5	1.5%	0.0035 mm																																																																				
1440	1	1.0%	0.0014 mm																																																																				
<b>% Gravel:</b> 0.2% <b>% Sand:</b> 80.4% <b>% Silt:</b> 17.1% <b>% Clay:</b> 2.3%	<b>Liquid Limit:</b> 0.0 % <b>Plastic Limit:</b> 0.0 % <b>Plasticity Index:</b> 0.0 %																																																																						
<b>USDA Soil Textural Classification</b>																																																																							
<table style="width: 100%;"> <tr> <td style="width: 50%;"><b>% Sand:</b></td> <td style="width: 50%;">Particle Size: 2.0 - 0.05 mm</td> </tr> <tr> <td><b>% Silt:</b></td> <td>0.05 - 0.002 mm</td> </tr> <tr> <td><b>% Clay:</b></td> <td>&lt; 0.002 mm</td> </tr> </table> <table style="width: 100%; text-align: center;"> <tr><td colspan="2"><b>USDA Soil Textural Classification</b></td></tr> <tr><td colspan="2">Sand</td></tr> </table>	<b>% Sand:</b>	Particle Size: 2.0 - 0.05 mm	<b>% Silt:</b>	0.05 - 0.002 mm	<b>% Clay:</b>	< 0.002 mm	<b>USDA Soil Textural Classification</b>		Sand																																																														
<b>% Sand:</b>	Particle Size: 2.0 - 0.05 mm																																																																						
<b>% Silt:</b>	0.05 - 0.002 mm																																																																						
<b>% Clay:</b>	< 0.002 mm																																																																						
<b>USDA Soil Textural Classification</b>																																																																							
Sand																																																																							

All results apply only to actual locations and materials tested. As a mutual protection to clients, the public and ourselves, all reports are submitted as the confidential property of clients, and authorization for publication of statements, conclusions or extracts from or regarding our reports is reserved pending our written approval.

**Comments:** \_\_\_\_\_

\_\_\_\_\_

\_\_\_\_\_

**Reviewed by:**  \_\_\_\_\_

Meghan Blodgett-Carrillo

# Direct Shear Test Results:

ASTM D-3080



Project: Q.C. - Lower Duwamish Waterway  
 Project Number: 21B233  
 Laboratory Sample ID: B21-1451  
 Sample Date: 7/8/2021  
 Test Date: 8/23/2021  
 Technician: M. Carrillo

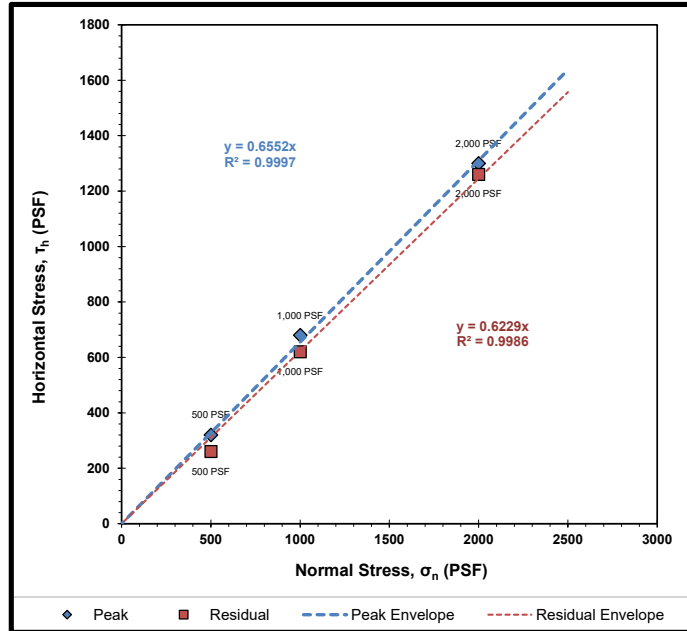
Sample Source: LDW21-GT12-GB-18-22 ft  
 Visual Soil Description: brown clayey silt  
 Type of Specimen: Remolded Cylindrical Shear Box  
 Specimen Diameter (in): 2.5  
 Specimen Height (in): 1  
 Rate of Strain (in/min): 0.0208  
 Estimated Specific Gravity of Solids: 2.65

Summary of Sample Data: $\sigma_n=500$ PSF		
Initial Moisture Content (%)	34.3	
	Initial	Post-Consolidation
Dry Density (PCF):	104.7	112.4
Void Ratio:	0.609	0.499
Porosity (%):	37.9	33.3
Degree of Saturation (%):	saturated	saturated

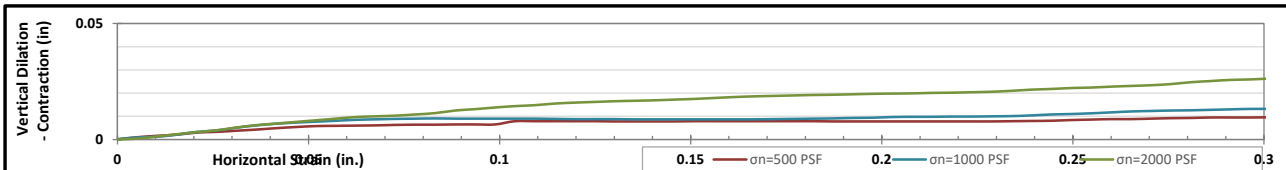
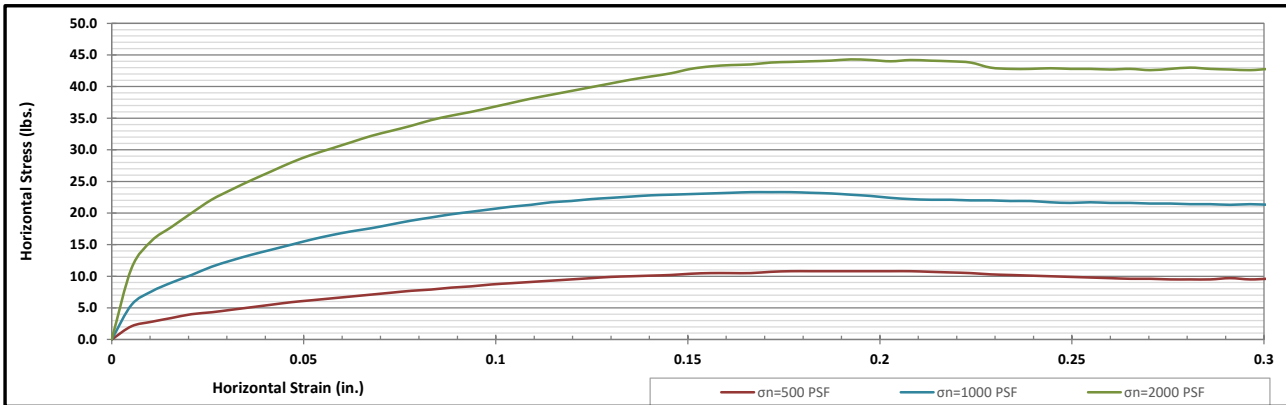
Summary of Sample Data: $\sigma_n=1000$ PSF		
Initial Moisture Content (%)	32.5	
	Initial	Post-Consolidation
Dry Density (PCF):	106.6	117.5
Void Ratio:	0.580	0.433
Porosity (%):	36.7	30.2
Degree of Saturation (%):	saturated	saturated

Summary of Sample Data: $\sigma_n=2000$ PSF		
Initial Moisture Content (%)	34.7	
	Initial	Post-Consolidation
Dry Density (PCF):	104.7	119.6
Void Ratio:	0.609	0.409
Porosity (%):	37.8	29.0
Degree of Saturation (%):	saturated	saturated

ESTIMATED STRENGTH PARAMETERS		
	PEAK	RESIDUAL
Angle of Internal Friction, $\phi$ (°):	33	32
Cohesion (PSF):	0	0



Failure Envelope Test Values:			
Normal Stress, $\sigma_n$ (PSF):	500	1000	2000
Peak Horizontal Stress, $\tau_h$ (PSF):	320	680	1300
Residual Horizontal Stress, $\tau_h$ (PSF):	260	620	1260



Corporate • 777 Chrysler Drive • Burlington, WA 98233 • Phone 360.755.1990 • Fax 360.755.1980  
 SW Region • 2118 Black Lake Blvd. S.W. • Olympia, WA 98512 • Phone 360.534.9777 • Fax 360.534.9779  
 NW Region • 805 Dupont, Suite #5 • Bellingham, WA 98225 • Phone 360.647.6061 • Fax 360.647.8111  
 Kitsap Region • 5451 N.W. Newberry Hill Road, Suite 101 • Silverdale, WA 98383 • Phone/Fax 360.698.6787

Visit our website: [www.mtc-inc.net](http://www.mtc-inc.net)



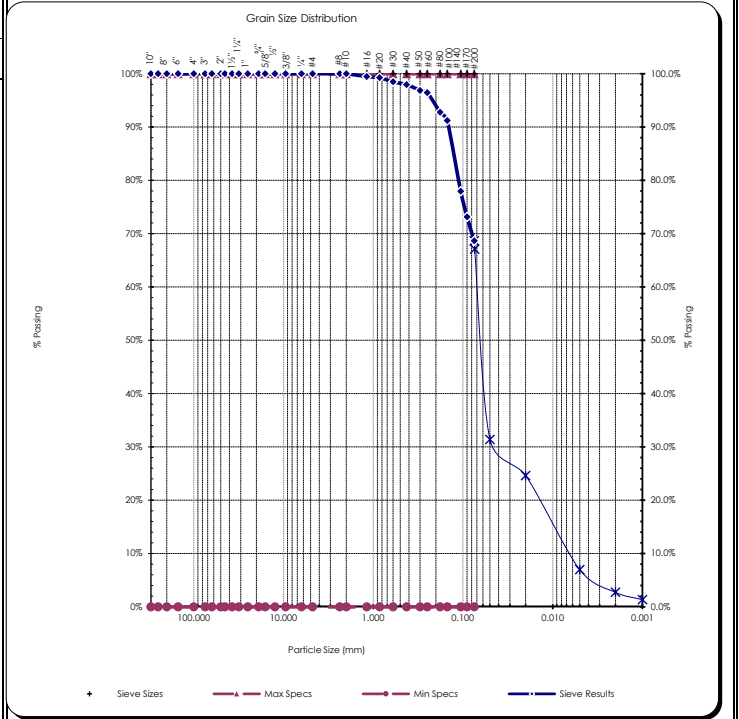
# Sieve Report

<b>Project:</b> Q.C. - Lower Duwamish Waterway <b>Project #:</b> 21B233 <b>Client:</b> Anchor QEA <b>Source:</b> LDW21-GT11-GB-0-8.5 ft <b>Sample#:</b> B21-1454	<b>Date Received:</b> 29-Jul-21 <b>Sampled By:</b> Client <b>Date Tested:</b> 31-Aug-21 <b>Tested By:</b> C. Kriss	<b>Unified Soil Classification System, ASTM-2487</b> ML, Sandy Silt <b>Sample Color:</b> brown	 Certificate #: 1366.01
--	---	---	----------------------------

<b>ASTM D2216, ASTM D2419, ASTM D4318, ASTM D5281</b>			
<b>Specifications</b> No Specs <b>Sample Meets Specs ? N/A</b>	D <sub>(5)</sub> = 0.004 mm	% Gravel = 0.0%	Coeff. of Curvature, C <sub>c</sub> = 3.47
	D <sub>(10)</sub> = 0.007 mm	% Sand = 31.3%	Coeff. of Uniformity, C <sub>u</sub> = 9.80
	D <sub>(15)</sub> = 0.010 mm	% Silt & Clay = 68.7%	Fineness Modulus = 0.14
	D <sub>(30)</sub> = 0.041 mm	Liquid Limit = 40.6%	Plastic Limit = 0.0%
	D <sub>(50)</sub> = 0.063 mm	Plasticity Index = 0.0%	Moisture %, as sampled = 89.0%
	D <sub>(60)</sub> = 0.069 mm	Sand Equivalent = n/a	Req'd Sand Equivalent =
	D <sub>(90)</sub> = 0.146 mm	Fracture %, 1 Face = n/a	Req'd Fracture %, 1 Face =
	Dust Ratio = 68/97	Fracture %, 2+ Faces = n/a	Req'd Fracture %, 2+ Faces =

**ASTM C136, ASTM D6913, ASTM C117**

Sieve Size		Actual Cumulative Percent Passing	Interpolated Cumulative Percent Passing	Specs Max	Specs Min
US	Metric				
12.00"	300.00		100%	100.0%	0.0%
10.00"	250.00		100%	100.0%	0.0%
8.00"	200.00		100%	100.0%	0.0%
6.00"	150.00		100%	100.0%	0.0%
4.00"	100.00		100%	100.0%	0.0%
3.00"	75.00		100%	100.0%	0.0%
2.50"	63.00		100%	100.0%	0.0%
2.00"	50.00	100%	100%	100.0%	0.0%
1.75"	45.00		100%	100.0%	0.0%
1.50"	37.50		100%	100.0%	0.0%
1.25"	31.50		100%	100.0%	0.0%
1.00"	25.00	100%	100%	100.0%	0.0%
3/4"	19.00	100%	100%	100.0%	0.0%
5/8"	16.00		100%	100.0%	0.0%
1/2"	12.50	100%	100%	100.0%	0.0%
3/8"	9.50	100%	100%	100.0%	0.0%
1/4"	6.30		100%	100.0%	0.0%
#4	4.75	100%	100%	100.0%	0.0%
#8	2.36		100%	100.0%	0.0%
#10	2.00	100%	100%	100.0%	0.0%
#16	1.18	99%	99%	100.0%	0.0%
#20	0.850	99%	99%	100.0%	0.0%
#30	0.600	98%	98%	100.0%	0.0%
#40	0.425	98%	98%	100.0%	0.0%
#50	0.300	97%	97%	100.0%	0.0%
#60	0.250	96%	96%	100.0%	0.0%
#80	0.180	93%	93%	100.0%	0.0%
#100	0.150	91%	91%	100.0%	0.0%
#140	0.106	78%	78%	100.0%	0.0%
#170	0.090	73%	73%	100.0%	0.0%
#200	0.075	68.7%	68.7%	100.0%	0.0%




Copyright Spears Engineering & Technical Services PS, 1996-98  
 All results apply only to actual locations and materials tested. As a mutual protection to clients, the public and ourselves, all reports are submitted as the confidential property of clients, and authorization for publication of statements, conclusions or extracts from or regarding our reports is reserved pending our written approval.

**Comments:** \_\_\_\_\_

Reviewed by:   
 Meghan Blodgett-Carrillo



## Hydrometer Report


<b>Project:</b> Q.C. - Lower Duwamish Waterway <b>Project #:</b> 21B233 <b>Client:</b> Anchor QEA <b>Source:</b> LDW21-GT11-GB-0-8.5 ft <b>Sample#:</b> B21-1454	<b>Date Received:</b> 29-Jul-21 <b>Sampled By:</b> Client <b>Date Tested:</b> 31-Aug-21 <b>Tested By:</b> C. Kriss	<b>Unified Soil Classification System, ASTM-2487</b> ML, Sandy Silt <b>Sample Color</b> brown																																			
<b>ASTM D7928, HYDROMETER ANALYSIS</b>		<b>ASTM D6913</b>																																			
<b>Assumed Sp Gr :</b> 2.65 <b>Sample Weight:</b> 53.60 grams <b>Hydroscopic Moist.:</b> 4.63% <b>Adj. Sample Wgt :</b> 51.23 grams		<b>Sieve Analysis</b> <b>Grain Size Distribution</b>																																			
 ACCREDITED Certificate #: 1366.01																																					
<b>Hydrometer</b> <table border="1" style="margin-left: auto; margin-right: auto;"> <thead> <tr> <th>Reading Minutes</th> <th>Corrected Reading</th> <th>Percent Passing</th> <th>Soils Particle Diameter</th> </tr> </thead> <tbody> <tr><td>1</td><td>16</td><td>31.2%</td><td>0.0505 mm</td></tr> <tr><td>2</td><td>15</td><td>29.3%</td><td>0.0359 mm</td></tr> <tr><td>5</td><td>14</td><td>27.3%</td><td>0.0228 mm</td></tr> <tr><td>15</td><td>9.5</td><td>18.5%</td><td>0.0136 mm</td></tr> <tr><td>30</td><td>7.5</td><td>14.6%</td><td>0.0097 mm</td></tr> <tr><td>60</td><td>5</td><td>9.8%</td><td>0.0069 mm</td></tr> <tr><td>240</td><td>2.5</td><td>4.9%</td><td>0.0035 mm</td></tr> <tr><td>1440</td><td>1</td><td>2.0%</td><td>0.0014 mm</td></tr> </tbody> </table>	Reading Minutes	Corrected Reading	Percent Passing	Soils Particle Diameter	1	16	31.2%	0.0505 mm	2	15	29.3%	0.0359 mm	5	14	27.3%	0.0228 mm	15	9.5	18.5%	0.0136 mm	30	7.5	14.6%	0.0097 mm	60	5	9.8%	0.0069 mm	240	2.5	4.9%	0.0035 mm	1440	1	2.0%	0.0014 mm	
Reading Minutes	Corrected Reading	Percent Passing	Soils Particle Diameter																																		
1	16	31.2%	0.0505 mm																																		
2	15	29.3%	0.0359 mm																																		
5	14	27.3%	0.0228 mm																																		
15	9.5	18.5%	0.0136 mm																																		
30	7.5	14.6%	0.0097 mm																																		
60	5	9.8%	0.0069 mm																																		
240	2.5	4.9%	0.0035 mm																																		
1440	1	2.0%	0.0014 mm																																		
<table style="width: 100%;"> <tr> <td><b>% Gravel:</b> 0.0%</td> <td><b>Liquid Limit:</b> 40.6 %</td> </tr> <tr> <td><b>% Sand:</b> 31.3%</td> <td><b>Plastic Limit:</b> 0.0 %</td> </tr> <tr> <td><b>% Silt:</b> 61.7%</td> <td><b>Plasticity Index:</b> 0.0 %</td> </tr> <tr> <td><b>% Clay:</b> 7.0%</td> <td></td> </tr> </table>	<b>% Gravel:</b> 0.0%	<b>Liquid Limit:</b> 40.6 %	<b>% Sand:</b> 31.3%	<b>Plastic Limit:</b> 0.0 %	<b>% Silt:</b> 61.7%	<b>Plasticity Index:</b> 0.0 %	<b>% Clay:</b> 7.0%																														
<b>% Gravel:</b> 0.0%	<b>Liquid Limit:</b> 40.6 %																																				
<b>% Sand:</b> 31.3%	<b>Plastic Limit:</b> 0.0 %																																				
<b>% Silt:</b> 61.7%	<b>Plasticity Index:</b> 0.0 %																																				
<b>% Clay:</b> 7.0%																																					
<b>USDA Soil Textural Classification</b>																																					
<table style="width: 100%;"> <tr> <td><b>% Sand:</b></td> <td><b>Particle Size</b></td> </tr> <tr> <td><b>% Silt:</b></td> <td>2.0 - 0.05 mm</td> </tr> <tr> <td><b>% Clay:</b></td> <td>0.05 - 0.002 mm</td> </tr> <tr> <td></td> <td>&lt; 0.002 mm</td> </tr> </table>	<b>% Sand:</b>	<b>Particle Size</b>	<b>% Silt:</b>	2.0 - 0.05 mm	<b>% Clay:</b>	0.05 - 0.002 mm		< 0.002 mm																													
<b>% Sand:</b>	<b>Particle Size</b>																																				
<b>% Silt:</b>	2.0 - 0.05 mm																																				
<b>% Clay:</b>	0.05 - 0.002 mm																																				
	< 0.002 mm																																				
<b>USDA Soil Textural Classification</b> Sandy Loam																																					

All results apply only to actual locations and materials tested. As a mutual protection to clients, the public and ourselves, all reports are submitted as the confidential property of clients, and authorization for publication of statements, conclusions or extracts from or regarding our reports is reserved pending our written approval.

**Comments:** \_\_\_\_\_

\_\_\_\_\_

\_\_\_\_\_

**Reviewed by:**  \_\_\_\_\_

Meghan Blodgett-Carrillo



## ASTM D4318 - Liquid Limit, Plastic Limit and Plasticity Index of Soils

<b>Project:</b> Q.C. - Lower Duwamish Waterway <b>Project #:</b> 21B233 <b>Client:</b> Anchor QEA <b>Source:</b> LDW21-GT11-GB-0-8.5 ft <b>Sample #:</b> B21-1454	<b>Date Received:</b> 29-Jul-21 <b>Sampled By:</b> Client <b>Date Tested:</b> 31-Aug-21 <b>Tested By:</b> C. Kriss	<b>Unified Soils Classification System, ASTM D-2487</b> ML, Sandy Silt <b>Sample Color</b> brown
---	---	---

### Liquid Limit Determination

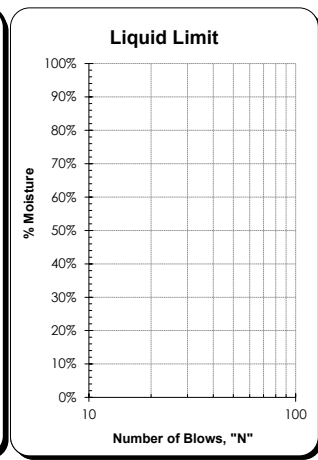
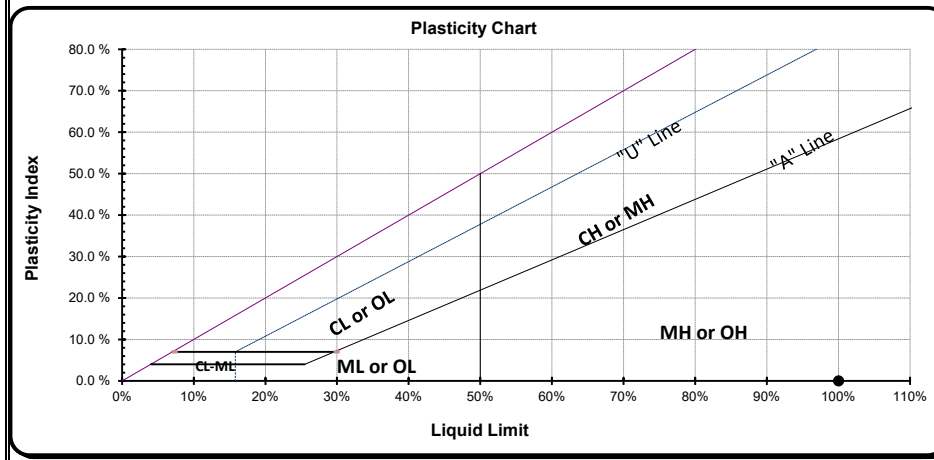
	#1	#2	#3	#4	#5	#6
<b>Weight of Wet Soils + Pan:</b>	32.18	28.53	30.48			
<b>Weight of Dry Soils + Pan:</b>	28.57	24.52	27.32			
<b>Weight of Pan:</b>	19.55	15.03	19.88			
<b>Weight of Dry Soils:</b>	9.02	9.49	7.44			
<b>Weight of Moisture:</b>	3.61	4.01	3.16			
<b>% Moisture:</b>	40.0%	42.3%	42.5%			
<b>Number of Blows:</b>	28	17	15			



**Liquid Limit @ 25 Blows:** 41 %  
**Plastic Limit:** N/A  
**Plasticity Index, I<sub>p</sub>:** N/A

### Plastic Limit Determination

	#1	#2	#3	#4	#5	#6
<b>Weight of Wet Soils + Pan:</b>						
<b>Weight of Dry Soils + Pan:</b>	Plastic limit cannot be determined					
<b>Weight of Pan:</b>						
<b>Weight of Dry Soils:</b>						
<b>Weight of Moisture:</b>						
<b>% Moisture:</b>						



Copyright Spears Engineering & Technical Services PS, 1996-98

All results apply only to actual locations and materials tested. As a mutual protection to clients, the public and ourselves, all reports are submitted as the confidential property of clients, and authorization for publication of statements, conclusions or extracts from or regarding our reports is reserved pending our written approval.

**Comments:** Plastic limit cannot be determined as the material does not roll down to 1/8" threads before cracking or crumbling.

Reviewed by:

Meghan Blodgett-Carrillo

# Direct Shear Test Results:

ASTM D-3080



Project: Q.C. - Lower Duwamish Waterway  
 Project Number: 21B233  
 Laboratory Sample ID: B21-1454  
 Sample Date: 7/8/2021  
 Test Date: 8/26/2021  
 Technician: M. Carrillo

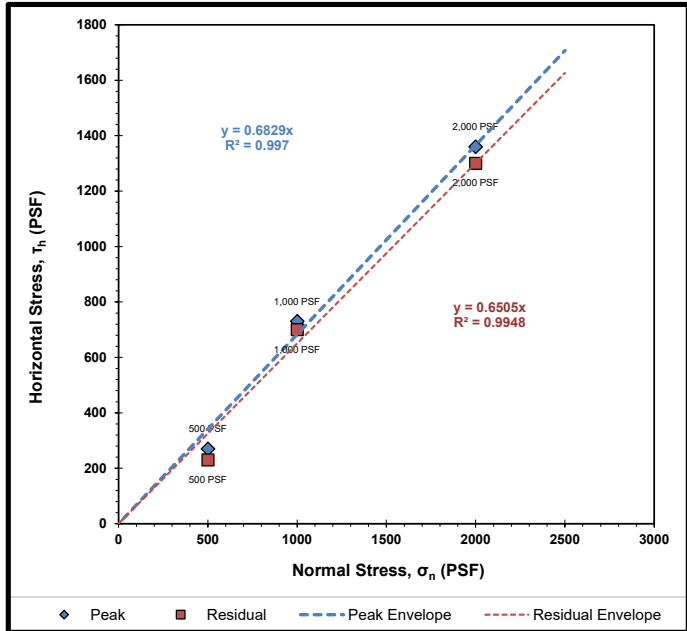
Sample Source: LDW21-GT11-GB-0-8.5 ft  
 Visual Soil Description: brown silty clay  
 Type of Specimen: Remolded Cylindrical Shear Box  
 Specimen Diameter (in): 2.5  
 Specimen Height (in): 1  
 Rate of Strain (in/min): 0.0042  
 Estimated Specific Gravity of Solids: 2.65

Summary of Sample Data: $\sigma_n=500$ PSF		
Initial Moisture Content (%):	58.2	
	Initial	Post-Consolidation
Dry Density (PCF):	76.6	86.1
Void Ratio:	1.201	0.957
Porosity (%):	54.6	48.9
Degree of Saturation (%):	saturated	saturated

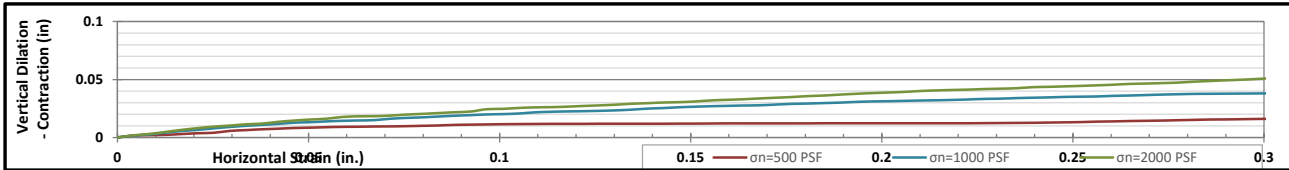
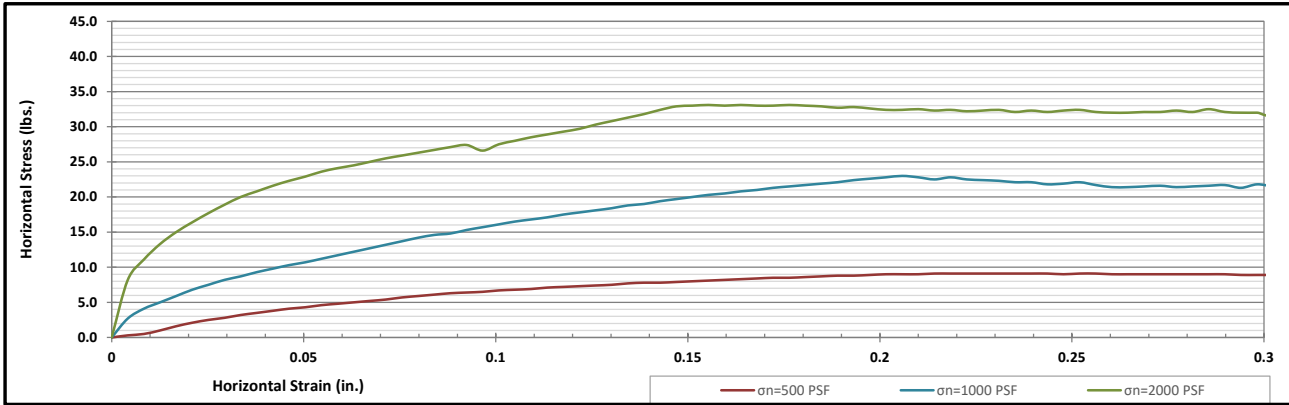
Summary of Sample Data: $\sigma_n=1000$ PSF		
Initial Moisture Content (%):	54.1	
	Initial	Post-Consolidation
Dry Density (PCF):	78.1	94.3
Void Ratio:	1.157	0.786
Porosity (%):	53.6	44.0
Degree of Saturation (%):	saturated	saturated

Summary of Sample Data: $\sigma_n=2000$ PSF		
Initial Moisture Content (%):	57.2	
	Initial	Post-Consolidation
Dry Density (PCF):	78.4	103.4
Void Ratio:	1.149	0.630
Porosity (%):	53.5	38.6
Degree of Saturation (%):	saturated	saturated

ESTIMATED STRENGTH PARAMETERS		
	PEAK	RESIDUAL
Angle of Internal Friction, $\phi$ (°):	34	33
Cohesion (PSF):	0	0



Failure Envelope Test Values:			
Normal Stress, $\sigma_n$ (PSF):	500	1000	2000
Peak Horizontal Stress, $\tau_h$ (PSF):	270	730	1360
Residual Horizontal Stress, $\tau_h$ (PSF):	230	700	1300



Corporate • 777 Chrysler Drive • Burlington, WA 98233 • Phone 360.755.1990 • Fax 360.755.1980  
 SW Region • 2118 Black Lake Blvd. S.W. • Olympia, WA 98512 • Phone 360.534.9777 • Fax 360.534.9779  
 NW Region • 805 Dupont, Suite #5 • Bellingham, WA 98225 • Phone 360.647.6061 • Fax 360.647.8111  
 Kitsap Region • 5451 N.W. Newberry Hill Road, Suite 101 • Silverdale, WA 98383 • Phone/Fax 360.698.6787

Visit our website: [www.mtc-inc.net](http://www.mtc-inc.net)

## ASTM D4318 - Liquid Limit, Plastic Limit and Plasticity Index of Soils

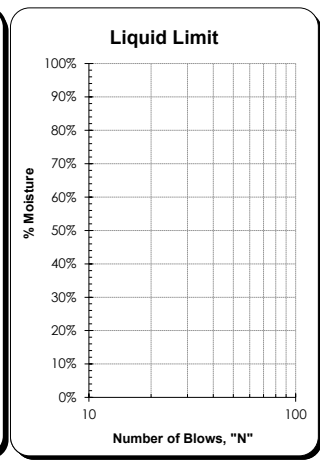
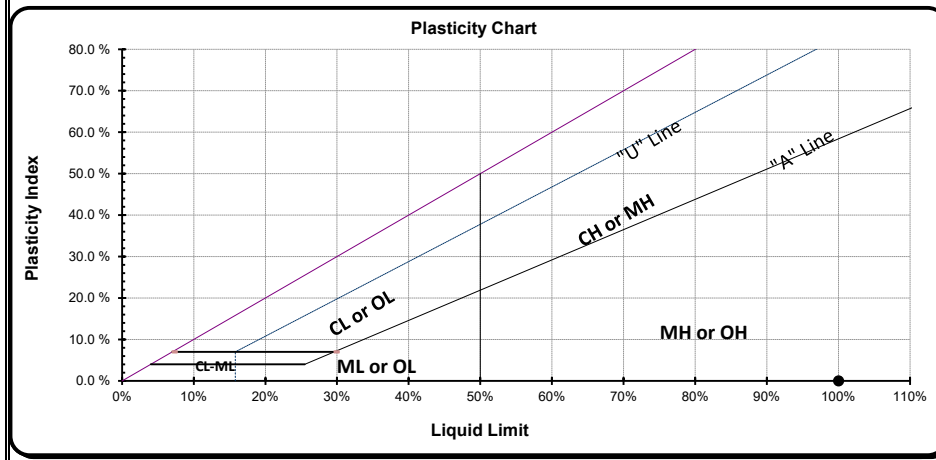
<b>Project:</b> Q.C. - Lower Duwamish Waterway <b>Project #:</b> 21B233 <b>Client:</b> Anchor QEA <b>Source:</b> LDW21-GT11-GB-8.5-16.7 ft <b>Sample #:</b> B21-1456	<b>Date Received:</b> 29-Jul-21 <b>Sampled By:</b> Client <b>Date Tested:</b> 31-Aug-21 <b>Tested By:</b> C. Kriss	<b>Visual Identification</b> Clayey Silt <b>Sample Color</b> brown
--	---	---

Liquid Limit Determination						
	#1	#2	#3	#4	#5	#6
Weight of Wet Soils + Pan:	33.23	29.16	29.46			
Weight of Dry Soils + Pan:	29.57	25.20	25.24			
Weight of Pan:	19.86	15.05	14.81			
Weight of Dry Soils:	9.71	10.15	10.43			
Weight of Moisture:	3.66	3.96	4.22			
% Moisture:	37.7 %	39.0 %	40.5 %			
Number of Blows:	26	17	11			



**Liquid Limit @ 25 Blows:** 38 %  
**Plastic Limit:** N/A  
**Plasticity Index, I<sub>p</sub>:** N/A

Plastic Limit Determination						
	#1	#2	#3	#4	#5	#6
Weight of Wet Soils + Pan:						
Weight of Dry Soils + Pan:	Plastic limit cannot be determined					
Weight of Pan:						
Weight of Dry Soils:						
Weight of Moisture:						
% Moisture:						



Copyright Spears Engineering & Technical Services PS, 1996-98

All results apply only to actual locations and materials tested. As a mutual protection to clients, the public and ourselves, all reports are submitted as the confidential property of clients, and authorization for publication of statements, conclusions or extracts from or regarding our reports is reserved pending our written approval.

**Comments:** Plastic limit cannot be determined as the material does not roll down to 1/8" threads before cracking or crumbling. Non-plastic.

Reviewed by:

Meghan Blodgett-Carrillo

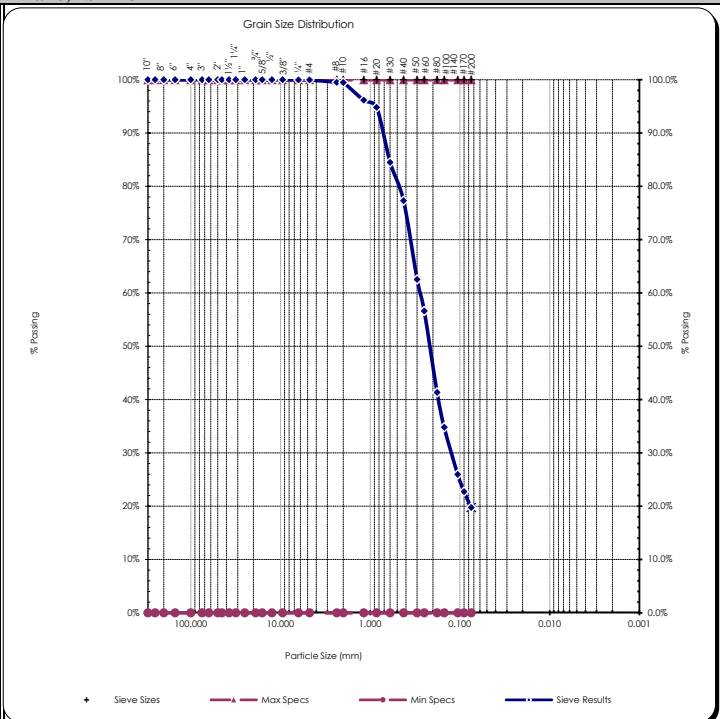


# Sieve Report

<b>Project:</b> Q.C. - Lower Duwamish Waterway <b>Project #:</b> 21B233 <b>Client:</b> Anchor QEA <b>Source:</b> LDW21-GT11-GB-16.7-18.5 ft <b>Sample#:</b> B21-1457	<b>Date Received:</b> 29-Jul-21 <b>Sampled By:</b> Client <b>Date Tested:</b> 31-Aug-21 <b>Tested By:</b> C. Kriss	<b>Unified Soil Classification System, ASTM-2487</b> SM, Silty Sand <b>Sample Color:</b> gray	 Certificate #: 1366.01
--	---	--	----------------------------

<b>ASTM D2216, ASTM D2419, ASTM D4318, ASTM D5281</b>			
<b>Specifications</b> No Specs <b>Sample Meets Specs ? N/A</b>	D <sub>(5)</sub> = 0.019 mm D <sub>(10)</sub> = 0.038 mm D <sub>(15)</sub> = 0.057 mm D <sub>(30)</sub> = 0.126 mm D <sub>(50)</sub> = 0.220 mm D <sub>(60)</sub> = 0.279 mm D <sub>(90)</sub> = 0.733 mm Dust Ratio = 23/90	% Gravel = 0.0% % Sand = 80.2% % Silt & Clay = 19.8% Liquid Limit = 0.0% Plasticity Index = 0.0% Sand Equivalent = n/a Fracture %, 1 Face = n/a Fracture %, 2+ Faces = n/a	Coeff. of Curvature, C <sub>c</sub> = 1.50 Coeff. of Uniformity, C <sub>u</sub> = 7.34 Fineness Modulus = 1.22 Plastic Limit = 0.0% Moisture %, as sampled = 27.0% Req'd Sand Equivalent = Req'd Fracture %, 1 Face = Req'd Fracture %, 2+ Faces =

ASTM C136, ASTM D6913, ASTM C117					
Sieve Size		Actual Cumulative Percent Passing	Interpolated Cumulative Percent Passing	Specs Max	Specs Min
US	Metric				
12.00"	300.00		100%	100.0%	0.0%
10.00"	250.00		100%	100.0%	0.0%
8.00"	200.00		100%	100.0%	0.0%
6.00"	150.00		100%	100.0%	0.0%
4.00"	100.00		100%	100.0%	0.0%
3.00"	75.00		100%	100.0%	0.0%
2.50"	63.00		100%	100.0%	0.0%
2.00"	50.00	100%	100%	100.0%	0.0%
1.75"	45.00	100%	100%	100.0%	0.0%
1.50"	37.50	100%	100%	100.0%	0.0%
1.25"	31.50	100%	100%	100.0%	0.0%
1.00"	25.00	100%	100%	100.0%	0.0%
3/4"	19.00	100%	100%	100.0%	0.0%
5/8"	16.00	100%	100%	100.0%	0.0%
1/2"	12.50	100%	100%	100.0%	0.0%
3/8"	9.50	100%	100%	100.0%	0.0%
1/4"	6.30	100%	100%	100.0%	0.0%
#4	4.75	100%	100%	100.0%	0.0%
#8	2.36	100%	100%	100.0%	0.0%
#10	2.00	99%	99%	100.0%	0.0%
#16	1.18	96%	96%	100.0%	0.0%
#20	0.850	95%	95%	100.0%	0.0%
#30	0.600	85%	85%	100.0%	0.0%
#40	0.425	77%	77%	100.0%	0.0%
#50	0.300	63%	63%	100.0%	0.0%
#60	0.250	57%	57%	100.0%	0.0%
#80	0.180	41%	41%	100.0%	0.0%
#100	0.150	35%	35%	100.0%	0.0%
#140	0.106	26%	26%	100.0%	0.0%
#170	0.090	23%	23%	100.0%	0.0%
#200	0.075	19.8%	19.8%	100.0%	0.0%



Copyright Spears Engineering & Technical Services PS, 1996-98  
 All results apply only to actual locations and materials tested. As a mutual protection to clients, the public and ourselves, all reports are submitted as the confidential property of clients, and authorization for publication of statements, conclusions or extracts from or regarding our reports is reserved pending our written approval.

**Comments:** \_\_\_\_\_

Reviewed by:   
 Meghan Blodgett-Carrillo

## ASTM D4318 - Liquid Limit, Plastic Limit and Plasticity Index of Soils

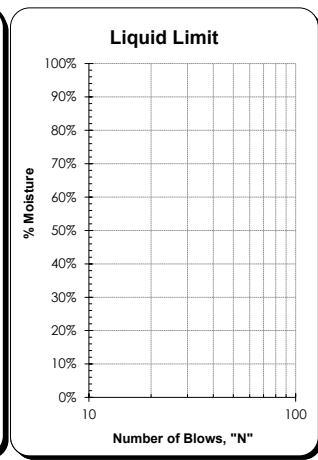
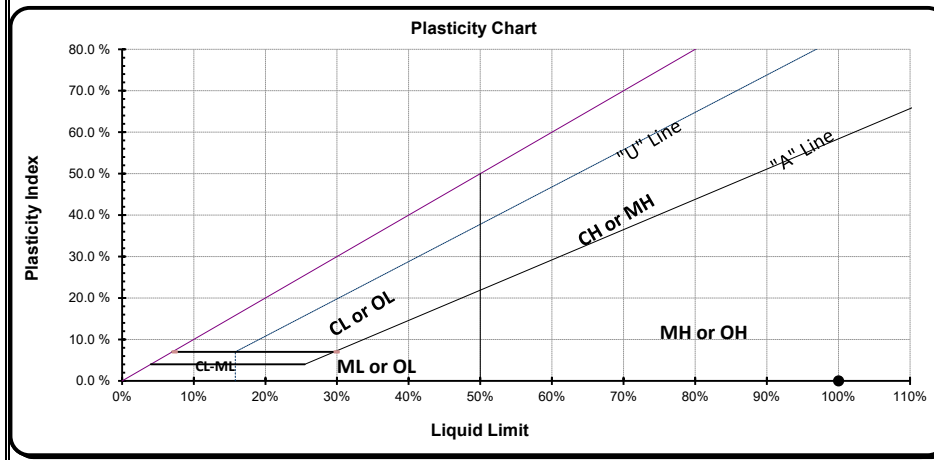
<b>Project:</b> Q.C. - Lower Duwamish Waterway <b>Project #:</b> 21B233 <b>Client:</b> Anchor QEA <b>Source:</b> LDW21-GT9-GB-0-1.5 ft <b>Sample #:</b> B21-1459	<b>Date Received:</b> 29-Jul-21 <b>Sampled By:</b> Client <b>Date Tested:</b> 31-Aug-21 <b>Tested By:</b> C. Kriss	<b>Visual Identification</b> Sandy Silt <b>Sample Color</b> brown
--	---	--

Liquid Limit Determination						
	#1	#2	#3	#4	#5	#6
Weight of Wet Soils + Pan:	Liquid limit cannot be established					
Weight of Dry Soils + Pan:						
Weight of Pan:						
Weight of Dry Soils:						
Weight of Moisture:						
% Moisture:						
Number of Blows:						



**Liquid Limit @ 25 Blows:** N/A  
**Plastic Limit:** N/A  
**Plasticity Index, I<sub>p</sub>:** N/A

Plastic Limit Determination						
	#1	#2	#3	#4	#5	#6
Weight of Wet Soils + Pan:	Plastic limit cannot be determined					
Weight of Dry Soils + Pan:						
Weight of Pan:						
Weight of Dry Soils:						
Weight of Moisture:						
% Moisture:						



All results apply only to actual locations and materials tested. As a mutual protection to clients, the public and ourselves, all reports are submitted as the confidential property of clients, and authorization for publication of statements, conclusions or extracts from or regarding our reports is reserved pending our written approval.

**Comments:** Liquid limit cannot be established as the material displays rapid dilation upon spreading into the cup. At lower moistures the material does not spread into the cup without tearing the soil cake. Plastic limit cannot be determined as the material does not roll down to 1/8" threads before cracking or crumbling. Non-plastic.

Reviewed by:   
 \_\_\_\_\_  
 Meghan Blodgett-Carrillo

## ASTM D4318 - Liquid Limit, Plastic Limit and Plasticity Index of Soils

<b>Project:</b> Q.C. - Lower Duwamish Waterway <b>Project #:</b> 21B233 <b>Client:</b> Anchor QEA <b>Source:</b> LDW21-GT9-GB-16-20-R <b>Sample #:</b> B21-1461	<b>Date Received:</b> 29-Jul-21 <b>Sampled By:</b> Client <b>Date Tested:</b> 31-Aug-21 E. Kriss	<b>Visual Identification</b> Sandy Silt with Clay <b>Sample Color</b> brown				
<div style="border: 1px solid red; padding: 2px; display: inline-block;"> <b>Name correction:</b>  <b>LDW21-GT9-GB-10-20</b> </div>						
<b>Liquid Limit Determination</b>						
	#1	#2	#3	#4	#5	#6
<b>Weight of Wet Soils + Pan:</b>						
<b>Weight of Dry Soils + Pan:</b>	Liquid limit cannot be established					
<b>Weight of Pan:</b>						
<b>Weight of Dry Soils:</b>						
<b>Weight of Moisture:</b>						
<b>% Moisture:</b>						
<b>Number of Blows:</b>						
<b>Plastic Limit Determination</b>						
	#1	#2	#3	#4	#5	#6
<b>Weight of Wet Soils + Pan:</b>						
<b>Weight of Dry Soils + Pan:</b>	Plastic limit cannot be determined					
<b>Weight of Pan:</b>						
<b>Weight of Dry Soils:</b>						
<b>Weight of Moisture:</b>						
<b>% Moisture:</b>						
<div style="display: flex; justify-content: space-between;"> <div style="width: 60%;"> </div> <div style="width: 35%;"> </div> </div>						



**Liquid Limit @ 25 Blows:** N/A  
**Plastic Limit:** N/A  
**Plasticity Index, I<sub>p</sub>:** N/A

Copyright: Spears Engineering & Technical Services PS, 1996-98  
 All results apply only to actual locations and materials tested. As a mutual protection to clients, the public and ourselves, all reports are submitted as the confidential property of clients, and authorization for publication of statements, conclusions or extracts from or regarding our reports is reserved pending our written approval.

**Comments:** Liquid limit cannot be established as the material displays rapid dilation upon spreading into the cup. At lower moistures the material does not spread into the cup without tearing the soil cake. Plastic limit cannot be determined as the material does not roll down to 1/8" threads before cracking or crumbling. Non-plastic.

Reviewed by:   
 Meghan Blodgett-Carrillo

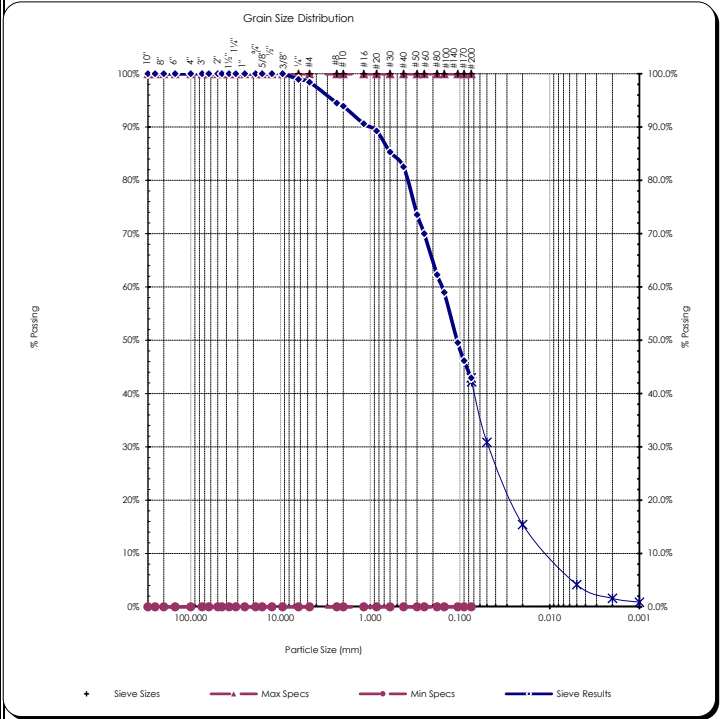


# Sieve Report

<b>Project:</b> Q.C. - Lower Duwamish Waterway <b>Project #:</b> 21B233 <b>Client:</b> Anchor QEA <b>Source:</b> LDW21-GT9-GB-20-21.5 ft <b>Sample#:</b> B21-1462	<b>Date Received:</b> 29-Jul-21 <b>Sampled By:</b> Client <b>Date Tested:</b> 31-Aug-21 <b>Tested By:</b> C. Kriss	<b>Unified Soil Classification System, ASTM-2487</b> SM, Silty Sand <b>Sample Color:</b> brown	 Certificate #: 1366.01
---	---	---	----------------------------

<b>ASTM D2216, ASTM D2419, ASTM D4318, ASTM D5281</b>			
<b>Specifications</b> No Specs <b>Sample Meets Specs ? N/A</b>	$D_{(5)} = 0.006$ mm $D_{(10)} = 0.010$ mm $D_{(15)} = 0.019$ mm $D_{(30)} = 0.058$ mm $D_{(50)} = 0.108$ mm $D_{(60)} = 0.159$ mm $D_{(90)} = 1.026$ mm Dust Ratio = 38/73	% Gravel = 1.6% % Sand = 55.5% % Silt & Clay = 43.0% Liquid Limit = n/a Plasticity Index = n/a Sand Equivalent = n/a Fracture %, 1 Face = n/a Fracture %, 2+ Faces = n/a	Coeff. of Curvature, $C_c = 2.18$ Coeff. of Uniformity, $C_u = 16.63$ Fineness Modulus = 0.99 Plastic Limit = n/a Moisture %, as sampled = 26.8% Req'd Sand Equivalent = Req'd Fracture %, 1 Face = Req'd Fracture %, 2+ Faces =

<b>ASTM C136, ASTM D6913, ASTM C117</b>					
Sieve Size		Actual Cumulative Percent Passing	Interpolated Cumulative Percent Passing	Specs Max	Specs Min
US	Metric				
12.00"	300.00		100%	100.0%	0.0%
10.00"	250.00		100%	100.0%	0.0%
8.00"	200.00		100%	100.0%	0.0%
6.00"	150.00		100%	100.0%	0.0%
4.00"	100.00		100%	100.0%	0.0%
3.00"	75.00		100%	100.0%	0.0%
2.50"	63.00		100%	100.0%	0.0%
2.00"	50.00	100%	100%	100.0%	0.0%
1.75"	45.00	100%	100%	100.0%	0.0%
1.50"	37.50	100%	100%	100.0%	0.0%
1.25"	31.50	100%	100%	100.0%	0.0%
1.00"	25.00	100%	100%	100.0%	0.0%
3/4"	19.00	100%	100%	100.0%	0.0%
5/8"	16.00	100%	100%	100.0%	0.0%
1/2"	12.50	100%	100%	100.0%	0.0%
3/8"	9.50	100%	100%	100.0%	0.0%
1/4"	6.30	99%	99%	100.0%	0.0%
#4	4.75	98%	98%	100.0%	0.0%
#8	2.36	95%	95%	100.0%	0.0%
#10	2.00	94%	94%	100.0%	0.0%
#16	1.18	91%	91%	100.0%	0.0%
#20	0.850	89%	89%	100.0%	0.0%
#30	0.600	85%	85%	100.0%	0.0%
#40	0.425	83%	83%	100.0%	0.0%
#50	0.300	74%	74%	100.0%	0.0%
#60	0.250	70%	70%	100.0%	0.0%
#80	0.180	62%	62%	100.0%	0.0%
#100	0.150	59%	59%	100.0%	0.0%
#140	0.106	50%	50%	100.0%	0.0%
#170	0.090	46%	46%	100.0%	0.0%
#200	0.075	43.0%	43.0%	100.0%	0.0%



Copyright Spears Engineering & Technical Services PS, 1996-98  
 All results apply only to actual locations and materials tested. As a mutual protection to clients, the public and ourselves, all reports are submitted as the confidential property of clients, and authorization for publication of statements, conclusions or extracts from or regarding our reports is reserved pending our written approval.

**Comments:** \_\_\_\_\_

Reviewed by:   
 Meghan Blodgett-Carrillo



## Hydrometer Report

<b>Project:</b> Q.C. - Lower Duwamish Waterway <b>Project #:</b> 21B233 <b>Client:</b> Anchor QEA <b>Source:</b> LDW21-GT9-GB-20-21.5 ft <b>Sample#:</b> B21-1462	<b>Date Received:</b> 29-Jul-21 <b>Sampled By:</b> Client <b>Date Tested:</b> 31-Aug-21 <b>Tested By:</b> C. Kriss	<b>Unified Soil Classification System, ASTM-2487</b> SM, Silty Sand <b>Sample Color</b> brown																																																																																																																																											
<b>ASTM D7928, HYDROMETER ANALYSIS</b>		<b>ASTM D6913</b>																																																																																																																																											
<table style="width: 100%; border-collapse: collapse;"> <tr> <td style="width: 30%;"><b>Assumed Sp Gr :</b></td> <td style="width: 10%; text-align: center;">2.65</td> <td style="width: 60%;"></td> </tr> <tr> <td><b>Sample Weight:</b></td> <td style="text-align: center;">75.17</td> <td>grams</td> </tr> <tr> <td><b>Hydroscopic Moist.:</b></td> <td style="text-align: center;">1.11%</td> <td></td> </tr> <tr> <td><b>Adj. Sample Wgt :</b></td> <td style="text-align: center;">74.34</td> <td>grams</td> </tr> </table> <div style="text-align: center; margin-top: 10px;"> <p><b>ACCREDITED</b> Certificate #: 1366.01</p> </div> <table style="width: 100%; border-collapse: collapse; margin-top: 10px;"> <thead> <tr> <th style="text-align: left;">Hydrometer Reading</th> <th style="text-align: left;">Corrected Reading</th> <th style="text-align: left;">Percent Passing</th> <th style="text-align: left;">Soils Particle Diameter</th> </tr> </thead> <tbody> <tr><td>1</td><td>19</td><td>24.0%</td><td>0.0496 mm</td></tr> <tr><td>2</td><td>16.5</td><td>20.8%</td><td>0.0357 mm</td></tr> <tr><td>5</td><td>13.5</td><td>17.1%</td><td>0.0230 mm</td></tr> <tr><td>15</td><td>9.5</td><td>12.0%</td><td>0.0136 mm</td></tr> <tr><td>30</td><td>8</td><td>10.1%</td><td>0.0097 mm</td></tr> <tr><td>60</td><td>5</td><td>6.3%</td><td>0.0069 mm</td></tr> <tr><td>240</td><td>2</td><td>2.5%</td><td>0.0035 mm</td></tr> <tr><td>1440</td><td>1</td><td>1.3%</td><td>0.0014 mm</td></tr> </tbody> </table> <table style="width: 100%; border-collapse: collapse; margin-top: 10px;"> <tr> <td style="width: 30%;"><b>% Gravel:</b></td> <td style="width: 30%;">1.6%</td> <td style="width: 30%;"><b>Liquid Limit:</b></td> <td>n/a</td> </tr> <tr> <td><b>% Sand:</b></td> <td>55.5%</td> <td><b>Plastic Limit:</b></td> <td>n/a</td> </tr> <tr> <td><b>% Silt:</b></td> <td>38.8%</td> <td><b>Plasticity Index:</b></td> <td>n/a</td> </tr> <tr> <td><b>% Clay:</b></td> <td>4.2%</td> <td></td> <td></td> </tr> </table>		<b>Assumed Sp Gr :</b>	2.65		<b>Sample Weight:</b>	75.17	grams	<b>Hydroscopic Moist.:</b>	1.11%		<b>Adj. Sample Wgt :</b>	74.34	grams	Hydrometer Reading	Corrected Reading	Percent Passing	Soils Particle Diameter	1	19	24.0%	0.0496 mm	2	16.5	20.8%	0.0357 mm	5	13.5	17.1%	0.0230 mm	15	9.5	12.0%	0.0136 mm	30	8	10.1%	0.0097 mm	60	5	6.3%	0.0069 mm	240	2	2.5%	0.0035 mm	1440	1	1.3%	0.0014 mm	<b>% Gravel:</b>	1.6%	<b>Liquid Limit:</b>	n/a	<b>% Sand:</b>	55.5%	<b>Plastic Limit:</b>	n/a	<b>% Silt:</b>	38.8%	<b>Plasticity Index:</b>	n/a	<b>% Clay:</b>	4.2%			<table style="width: 100%; border-collapse: collapse;"> <tr> <th colspan="3" style="text-align: center;">Sieve Analysis</th> </tr> <tr> <th colspan="3" style="text-align: center;">Grain Size Distribution</th> </tr> <tr> <th style="text-align: left;">Sieve Size</th> <th style="text-align: left;">Percent Passing</th> <th style="text-align: left;">Soils Particle Diameter</th> </tr> <tr><td>3.0"</td><td>100%</td><td>75.000 mm</td></tr> <tr><td>2.0"</td><td>100%</td><td>50.000 mm</td></tr> <tr><td>1.5"</td><td>100%</td><td>37.500 mm</td></tr> <tr><td>1.25"</td><td>100%</td><td>31.500 mm</td></tr> <tr><td>1.0"</td><td>100%</td><td>25.000 mm</td></tr> <tr><td>3/4"</td><td>100%</td><td>19.000 mm</td></tr> <tr><td>5/8"</td><td>100%</td><td>16.000 mm</td></tr> <tr><td>1/2"</td><td>100%</td><td>12.500 mm</td></tr> <tr><td>3/8"</td><td>100%</td><td>9.500 mm</td></tr> <tr><td>1/4"</td><td>99%</td><td>6.300 mm</td></tr> <tr><td>#4</td><td>98%</td><td>4.750 mm</td></tr> <tr><td>#10</td><td>94%</td><td>2.000 mm</td></tr> <tr><td>#20</td><td>89%</td><td>0.850 mm</td></tr> <tr><td>#40</td><td>83%</td><td>0.425 mm</td></tr> <tr><td>#100</td><td>59%</td><td>0.150 mm</td></tr> <tr><td>#200</td><td>43.0%</td><td>0.075 mm</td></tr> <tr><td><b>Silts</b></td><td>42.2%</td><td>0.074 mm</td></tr> <tr><td></td><td>30.9%</td><td>0.050 mm</td></tr> <tr><td></td><td>15.4%</td><td>0.020 mm</td></tr> <tr><td><b>Clays</b></td><td>4.2%</td><td>0.005 mm</td></tr> <tr><td></td><td>1.6%</td><td>0.002 mm</td></tr> <tr><td><b>Colloids</b></td><td>0.9%</td><td>0.001 mm</td></tr> </table>	Sieve Analysis			Grain Size Distribution			Sieve Size	Percent Passing	Soils Particle Diameter	3.0"	100%	75.000 mm	2.0"	100%	50.000 mm	1.5"	100%	37.500 mm	1.25"	100%	31.500 mm	1.0"	100%	25.000 mm	3/4"	100%	19.000 mm	5/8"	100%	16.000 mm	1/2"	100%	12.500 mm	3/8"	100%	9.500 mm	1/4"	99%	6.300 mm	#4	98%	4.750 mm	#10	94%	2.000 mm	#20	89%	0.850 mm	#40	83%	0.425 mm	#100	59%	0.150 mm	#200	43.0%	0.075 mm	<b>Silts</b>	42.2%	0.074 mm		30.9%	0.050 mm		15.4%	0.020 mm	<b>Clays</b>	4.2%	0.005 mm		1.6%	0.002 mm	<b>Colloids</b>	0.9%	0.001 mm
<b>Assumed Sp Gr :</b>	2.65																																																																																																																																												
<b>Sample Weight:</b>	75.17	grams																																																																																																																																											
<b>Hydroscopic Moist.:</b>	1.11%																																																																																																																																												
<b>Adj. Sample Wgt :</b>	74.34	grams																																																																																																																																											
Hydrometer Reading	Corrected Reading	Percent Passing	Soils Particle Diameter																																																																																																																																										
1	19	24.0%	0.0496 mm																																																																																																																																										
2	16.5	20.8%	0.0357 mm																																																																																																																																										
5	13.5	17.1%	0.0230 mm																																																																																																																																										
15	9.5	12.0%	0.0136 mm																																																																																																																																										
30	8	10.1%	0.0097 mm																																																																																																																																										
60	5	6.3%	0.0069 mm																																																																																																																																										
240	2	2.5%	0.0035 mm																																																																																																																																										
1440	1	1.3%	0.0014 mm																																																																																																																																										
<b>% Gravel:</b>	1.6%	<b>Liquid Limit:</b>	n/a																																																																																																																																										
<b>% Sand:</b>	55.5%	<b>Plastic Limit:</b>	n/a																																																																																																																																										
<b>% Silt:</b>	38.8%	<b>Plasticity Index:</b>	n/a																																																																																																																																										
<b>% Clay:</b>	4.2%																																																																																																																																												
Sieve Analysis																																																																																																																																													
Grain Size Distribution																																																																																																																																													
Sieve Size	Percent Passing	Soils Particle Diameter																																																																																																																																											
3.0"	100%	75.000 mm																																																																																																																																											
2.0"	100%	50.000 mm																																																																																																																																											
1.5"	100%	37.500 mm																																																																																																																																											
1.25"	100%	31.500 mm																																																																																																																																											
1.0"	100%	25.000 mm																																																																																																																																											
3/4"	100%	19.000 mm																																																																																																																																											
5/8"	100%	16.000 mm																																																																																																																																											
1/2"	100%	12.500 mm																																																																																																																																											
3/8"	100%	9.500 mm																																																																																																																																											
1/4"	99%	6.300 mm																																																																																																																																											
#4	98%	4.750 mm																																																																																																																																											
#10	94%	2.000 mm																																																																																																																																											
#20	89%	0.850 mm																																																																																																																																											
#40	83%	0.425 mm																																																																																																																																											
#100	59%	0.150 mm																																																																																																																																											
#200	43.0%	0.075 mm																																																																																																																																											
<b>Silts</b>	42.2%	0.074 mm																																																																																																																																											
	30.9%	0.050 mm																																																																																																																																											
	15.4%	0.020 mm																																																																																																																																											
<b>Clays</b>	4.2%	0.005 mm																																																																																																																																											
	1.6%	0.002 mm																																																																																																																																											
<b>Colloids</b>	0.9%	0.001 mm																																																																																																																																											
<b>USDA Soil Textural Classification</b>																																																																																																																																													
	<table style="width: 100%; border-collapse: collapse;"> <tr><td><b>% Sand:</b></td><td>2.0 - 0.05 mm</td></tr> <tr><td><b>% Silt:</b></td><td>0.05 - 0.002 mm</td></tr> <tr><td><b>% Clay:</b></td><td>&lt; 0.002 mm</td></tr> </table>	<b>% Sand:</b>	2.0 - 0.05 mm	<b>% Silt:</b>	0.05 - 0.002 mm	<b>% Clay:</b>	< 0.002 mm																																																																																																																																						
<b>% Sand:</b>	2.0 - 0.05 mm																																																																																																																																												
<b>% Silt:</b>	0.05 - 0.002 mm																																																																																																																																												
<b>% Clay:</b>	< 0.002 mm																																																																																																																																												
<b>USDA Soil Textural Classification</b>																																																																																																																																													
Sandy Loam																																																																																																																																													

All results apply only to actual locations and materials tested. As a mutual protection to clients, the public and ourselves, all reports are submitted as the confidential property of clients, and authorization for publication of statements, conclusions or extracts from or regarding our reports is reserved pending our written approval.

**Comments:** \_\_\_\_\_

\_\_\_\_\_

\_\_\_\_\_

**Reviewed by:** \_\_\_\_\_

Meghan Blodgett-Carrillo



# Direct Shear Test Results:

ASTM D-3080



Project: Q.C. - Lower Duwamish Waterway  
 Project Number: 21B233  
 Laboratory Sample ID: B21-1462  
 Sample Date: 7/8/2021  
 Test Date: 8/31/2021  
 Technician: M. Carrillo

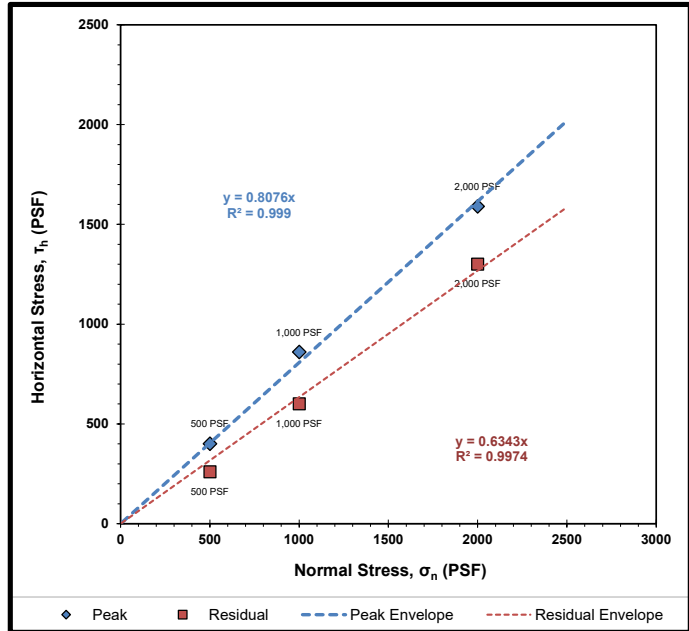
Sample Source: LDW21-GT9-GB-20-21.5 ft  
 Visual Soil Description: brown silty sand  
 Type of Specimen: Remolded Cylindrical Shear Box  
 Specimen Diameter (in): 2.5  
 Specimen Height (in): 1  
 Rate of Strain (in/min): 0.0042  
 Estimated Specific Gravity of Solids: 2.65

Summary of Sample Data: $\sigma_n=500$ PSF		
Initial Moisture Content (%):	22.7	
	Initial	Post-Consolidation
Dry Density (PCF):	112.8	114.5
Void Ratio:	0.494	0.471
Porosity (%):	33.0	32.0
Degree of Saturation (%):	saturated	saturated

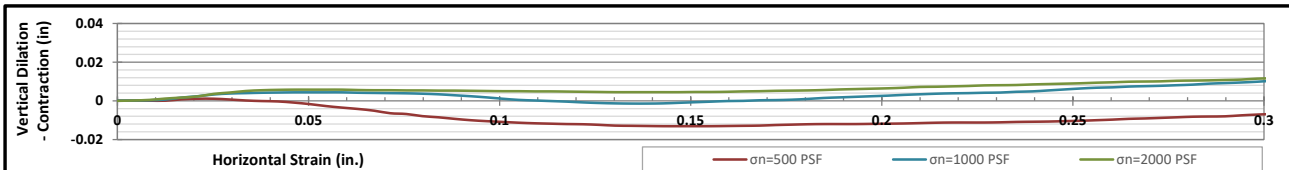
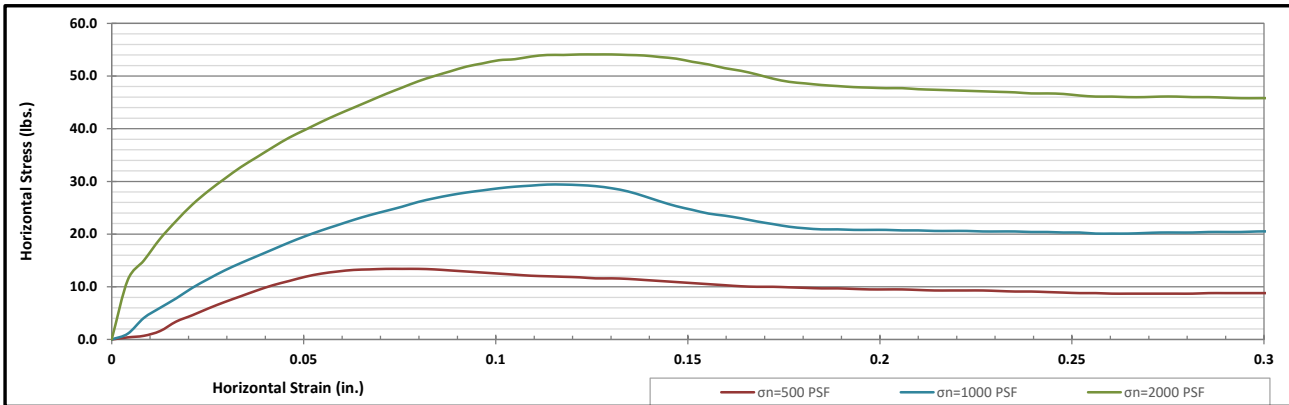
Summary of Sample Data: $\sigma_n=1000$ PSF		
Initial Moisture Content (%):	21.4	
	Initial	Post-Consolidation
Dry Density (PCF):	113.5	120.4
Void Ratio:	0.485	0.399
Porosity (%):	32.7	28.5
Degree of Saturation (%):	saturated	saturated

Summary of Sample Data: $\sigma_n=2000$ PSF		
Initial Moisture Content (%):	19.9	
	Initial	Post-Consolidation
Dry Density (PCF):	114.3	123.5
Void Ratio:	0.474	0.364
Porosity (%):	32.1	26.7
Degree of Saturation (%):	saturated	saturated

ESTIMATED STRENGTH PARAMETERS		
	PEAK	RESIDUAL
Angle of Internal Friction, $\phi$ (°):	39	32
Cohesion (PSF):	0	0



Failure Envelope Test Values:			
Normal Stress, $\sigma_n$ (PSF):	500	1000	2000
Peak Horizontal Stress, $\tau_h$ (PSF):	400	860	1590
Residual Horizontal Stress, $\tau_r$ (PSF):	260	600	1300



Corporate • 777 Chrysler Drive • Burlington, WA 98233 • Phone 360.755.1990 • Fax 360.755.1980  
 SW Region • 2118 Black Lake Blvd. S.W. • Olympia, WA 98512 • Phone 360.534.9777 • Fax 360.534.9779  
 NW Region • 805 Dupont, Suite #5 • Bellingham, WA 98225 • Phone 360.647.6061 • Fax 360.647.8111  
 Kitsap Region • 5451 N.W. Newberry Hill Road, Suite 101 • Silverdale, WA 98383 • Phone/Fax 360.698.6787

Visit our website: [www.mtc-inc.net](http://www.mtc-inc.net)



# Sieve Report

<b>Project:</b> Q.C. - Lower Duwamish Waterway <b>Project #:</b> 21B233 <b>Client:</b> Anchor QEA <b>Source:</b> LDW21-GT7-GB-0-5.7 ft <b>Sample#:</b> B21-1464	<b>Date Received:</b> 29-Jul-21 <b>Sampled By:</b> Client <b>Date Tested:</b> 31-Aug-21 <b>Tested By:</b> C. Kriss	<b>Unified Soil Classification System, ASTM-2487</b> SP-SM, Poorly graded Sand with Silt <b>Sample Color:</b> brown	 Certificate #: 1366.01
---	---	--	----------------------------

ASTM D2216, ASTM D2419, ASTM D4318, ASTM D5281

**Specifications**

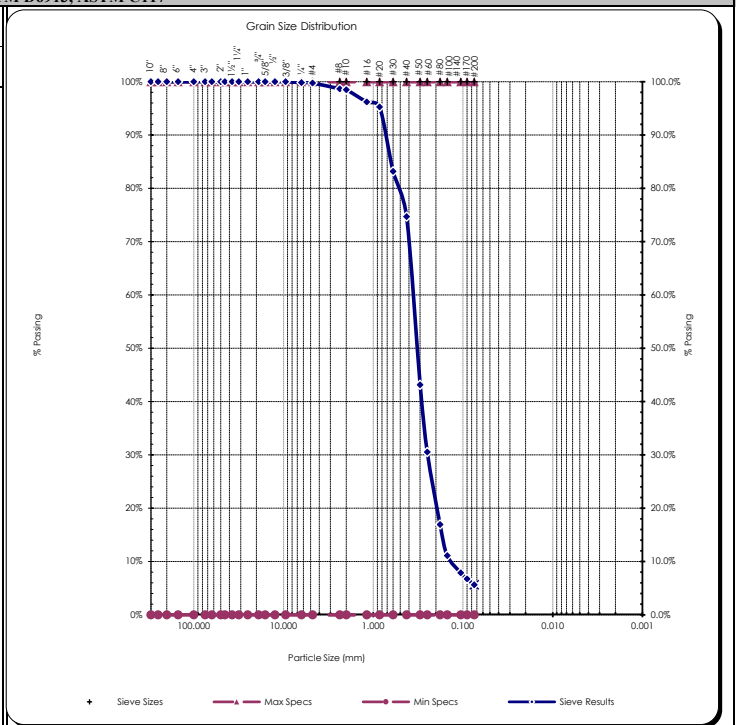
No Specs

Sample Meets Specs ? **N/A**

D <sub>(5)</sub> = 0.066 mm	% Gravel = 0.2%	Coeff. of Curvature, C <sub>c</sub> = 1.24
D <sub>(10)</sub> = 0.135 mm	% Sand = 94.1%	Coeff. of Uniformity, C <sub>u</sub> = 2.73
D <sub>(15)</sub> = 0.170 mm	% Silt & Clay = 5.6%	Fineness Modulus = 1.68
D <sub>(30)</sub> = 0.247 mm	Liquid Limit = 0.0%	Plastic Limit = 0.0%
D <sub>(50)</sub> = 0.327 mm	Plasticity Index = 0.0%	Moisture %, as sampled = 29.1%
D <sub>(60)</sub> = 0.367 mm	Sand Equivalent = n/a	Req'd Sand Equivalent =
D <sub>(90)</sub> = 0.741 mm	Fracture %, 1 Face = n/a	Req'd Fracture %, 1 Face =
Dust Ratio = 4/53	Fracture %, 2+ Faces = n/a	Req'd Fracture %, 2+ Faces =

ASTM C136, ASTM D6913, ASTM C117

Sieve Size		Actual Cumulative Percent Passing	Interpolated Cumulative Percent Passing	Specs Max	Specs Min
US	Metric				
12.00"	300.00		100%	100.0%	0.0%
10.00"	250.00		100%	100.0%	0.0%
8.00"	200.00		100%	100.0%	0.0%
6.00"	150.00		100%	100.0%	0.0%
4.00"	100.00		100%	100.0%	0.0%
3.00"	75.00		100%	100.0%	0.0%
2.50"	63.00		100%	100.0%	0.0%
2.00"	50.00	100%	100%	100.0%	0.0%
1.75"	45.00		100%	100.0%	0.0%
1.50"	37.50		100%	100.0%	0.0%
1.25"	31.50		100%	100.0%	0.0%
1.00"	25.00	100%	100%	100.0%	0.0%
3/4"	19.00	100%	100%	100.0%	0.0%
5/8"	16.00		100%	100.0%	0.0%
1/2"	12.50	100%	100%	100.0%	0.0%
3/8"	9.50	100%	100%	100.0%	0.0%
1/4"	6.30		100%	100.0%	0.0%
#4	4.75	100%	100%	100.0%	0.0%
#8	2.36		99%	100.0%	0.0%
#10	2.00	99%	99%	100.0%	0.0%
#16	1.18	95%	96%	100.0%	0.0%
#20	0.850	95%	95%	100.0%	0.0%
#30	0.600		83%	100.0%	0.0%
#40	0.425	75%	75%	100.0%	0.0%
#50	0.300		43%	100.0%	0.0%
#60	0.250	31%	31%	100.0%	0.0%
#80	0.180		17%	100.0%	0.0%
#100	0.150	11%	11%	100.0%	0.0%
#140	0.106		8%	100.0%	0.0%
#170	0.090		7%	100.0%	0.0%
#200	0.075	5.6%	5.6%	100.0%	0.0%



Copyright Spears Engineering & Technical Services PS, 1996-98  
 All results apply only to actual locations and materials tested. As a mutual protection to clients, the public and ourselves, all reports are submitted as the confidential property of clients, and authorization for publication of statements, conclusions or extracts from or regarding our reports is reserved pending our written approval.

Comments: \_\_\_\_\_

Reviewed by: *Meghan Blodgett-Carrillo*  
 Meghan Blodgett-Carrillo

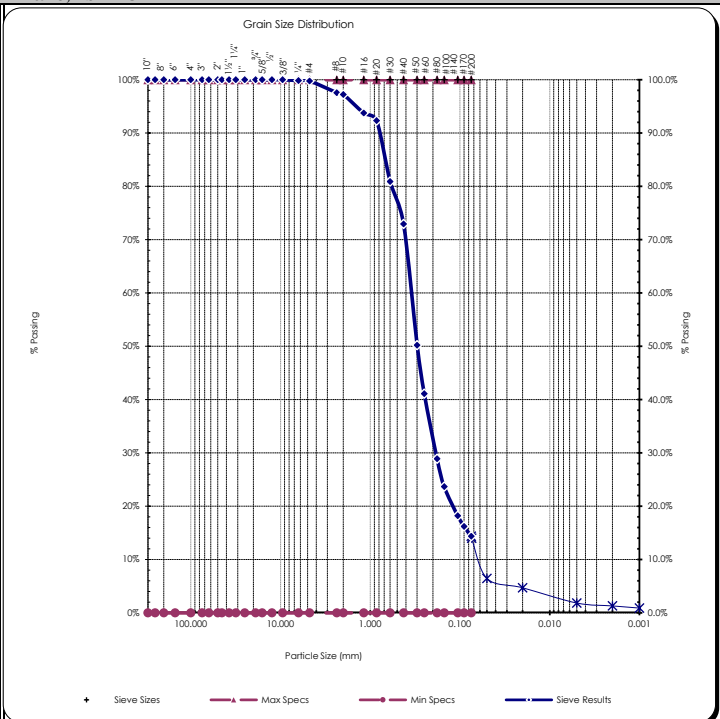


# Sieve Report

<b>Project:</b> Q.C. - Lower Duwamish Waterway <b>Project #:</b> 21B233 <b>Client:</b> Anchor QEA <b>Source:</b> LDW21-GT7-GB-8.5-18.5 ft <b>Sample#:</b> B21-1466	<b>Date Received:</b> 29-Jul-21 <b>Sampled By:</b> Client <b>Date Tested:</b> 31-Aug-21 <b>Tested By:</b> C. Kriss	<b>Unified Soil Classification System, ASTM-2487</b> SM, Silty Sand <b>Sample Color:</b> brown	 Certificate #: 1366.01
--	---	---	----------------------------

<b>ASTM D2216, ASTM D2419, ASTM D4318, ASTM D5281</b>			
<b>Specifications</b> No Specs <b>Sample Meets Specs ? N/A</b>	$D_{(5)} = 0.022$ mm $D_{(10)} = 0.063$ mm $D_{(15)} = 0.080$ mm $D_{(30)} = 0.186$ mm $D_{(50)} = 0.299$ mm $D_{(60)} = 0.354$ mm $D_{(90)} = 0.799$ mm Dust Ratio = 13/66	% Gravel = 0.2% % Sand = 85.4% % Silt & Clay = 14.4% Liquid Limit = n/a Plasticity Index = n/a Sand Equivalent = n/a Fracture %, 1 Face = n/a Fracture %, 2+ Faces = n/a	Coeff. of Curvature, $C_c = 1.55$ Coeff. of Uniformity, $C_u = 5.61$ Fineness Modulus = 1.54 Plastic Limit = n/a Moisture %, as sampled = 33.4% Req'd Sand Equivalent = Req'd Fracture %, 1 Face = Req'd Fracture %, 2+ Faces =

<b>ASTM C136, ASTM D6913, ASTM C117</b>					
Sieve Size		Actual Cumulative Percent Passing	Interpolated Cumulative Percent Passing	Specs Max	Specs Min
US	Metric				
12.00"	300.00		100%	100.0%	0.0%
10.00"	250.00		100%	100.0%	0.0%
8.00"	200.00		100%	100.0%	0.0%
6.00"	150.00		100%	100.0%	0.0%
4.00"	100.00		100%	100.0%	0.0%
3.00"	75.00		100%	100.0%	0.0%
2.50"	63.00		100%	100.0%	0.0%
2.00"	50.00	100%	100%	100.0%	0.0%
1.75"	45.00	100%	100%	100.0%	0.0%
1.50"	37.50	100%	100%	100.0%	0.0%
1.25"	31.50	100%	100%	100.0%	0.0%
1.00"	25.00	100%	100%	100.0%	0.0%
3/4"	19.00	100%	100%	100.0%	0.0%
5/8"	16.00	100%	100%	100.0%	0.0%
1/2"	12.50	100%	100%	100.0%	0.0%
3/8"	9.50	100%	100%	100.0%	0.0%
1/4"	6.30	100%	100%	100.0%	0.0%
#4	4.75	100%	100%	100.0%	0.0%
#8	2.36		98%	100.0%	0.0%
#10	2.00	97%	97%	100.0%	0.0%
#16	1.18	92%	94%	100.0%	0.0%
#20	0.850	92%	92%	100.0%	0.0%
#30	0.600		81%	100.0%	0.0%
#40	0.425	73%	73%	100.0%	0.0%
#50	0.300		50%	100.0%	0.0%
#60	0.250	41%	41%	100.0%	0.0%
#80	0.180		29%	100.0%	0.0%
#100	0.150	24%	24%	100.0%	0.0%
#140	0.106		18%	100.0%	0.0%
#170	0.090		16%	100.0%	0.0%
#200	0.075	14.4%	14.4%	100.0%	0.0%




Copyright Spears Engineering & Technical Services PS, 1996-98  
 All results apply only to actual locations and materials tested. As a mutual protection to clients, the public and ourselves, all reports are submitted as the confidential property of clients, and authorization for publication of statements, conclusions or extracts from or regarding our reports is reserved pending our written approval.

**Comments:** \_\_\_\_\_

Reviewed by:   
 Meghan Blodgett-Carrillo




## Hydrometer Report

<b>Project:</b> Q.C. - Lower Duwamish Waterway <b>Project #:</b> 21B233 <b>Client:</b> Anchor QEA <b>Source:</b> LDW21-GT7-GB-8.5-18.5 ft <b>Sample#:</b> B21-1466	<b>Date Received:</b> 29-Jul-21 <b>Sampled By:</b> Client <b>Date Tested:</b> 31-Aug-21 <b>Tested By:</b> C. Kriss	<b>Unified Soil Classification System, ASTM-2487</b> SM, Silty Sand <b>Sample Color</b> brown																																			
<b>ASTM D7928, HYDROMETER ANALYSIS</b>		<b>ASTM D6913</b>																																			
<b>Assumed Sp Gr :</b> 2.65 <b>Sample Weight:</b> 75.16 grams <b>Hydroscopic Moist.:</b> 1.29% <b>Adj. Sample Wgt :</b> 74.20 grams		<b>Sieve Analysis</b> <b>Grain Size Distribution</b>																																			
 ACCREDITED Certificate #: 1366.01																																					
<b>Hydrometer</b> <table border="1" style="margin-left: auto; margin-right: auto;"> <thead> <tr> <th>Reading Minutes</th> <th>Corrected Reading</th> <th>Percent Passing</th> <th>Soils Particle Diameter</th> </tr> </thead> <tbody> <tr><td>1</td><td>5</td><td>6.6%</td><td>0.0537 mm</td></tr> <tr><td>2</td><td>4.5</td><td>5.9%</td><td>0.0381 mm</td></tr> <tr><td>5</td><td>4</td><td>5.2%</td><td>0.0241 mm</td></tr> <tr><td>15</td><td>3</td><td>3.9%</td><td>0.0140 mm</td></tr> <tr><td>30</td><td>2.5</td><td>3.3%</td><td>0.0100 mm</td></tr> <tr><td>60</td><td>2</td><td>2.6%</td><td>0.0070 mm</td></tr> <tr><td>240</td><td>1</td><td>1.3%</td><td>0.0035 mm</td></tr> <tr><td>1440</td><td>1</td><td>1.3%</td><td>0.0014 mm</td></tr> </tbody> </table>	Reading Minutes	Corrected Reading	Percent Passing	Soils Particle Diameter	1	5	6.6%	0.0537 mm	2	4.5	5.9%	0.0381 mm	5	4	5.2%	0.0241 mm	15	3	3.9%	0.0140 mm	30	2.5	3.3%	0.0100 mm	60	2	2.6%	0.0070 mm	240	1	1.3%	0.0035 mm	1440	1	1.3%	0.0014 mm	
Reading Minutes	Corrected Reading	Percent Passing	Soils Particle Diameter																																		
1	5	6.6%	0.0537 mm																																		
2	4.5	5.9%	0.0381 mm																																		
5	4	5.2%	0.0241 mm																																		
15	3	3.9%	0.0140 mm																																		
30	2.5	3.3%	0.0100 mm																																		
60	2	2.6%	0.0070 mm																																		
240	1	1.3%	0.0035 mm																																		
1440	1	1.3%	0.0014 mm																																		
<b>% Gravel:</b> 0.2% <b>% Sand:</b> 85.4% <b>% Silt:</b> 12.5% <b>% Clay:</b> 1.9%	<b>Liquid Limit:</b> n/a <b>Plastic Limit:</b> n/a <b>Plasticity Index:</b> n/a																																				
<b>USDA Soil Textural Classification</b> <table border="1" style="margin-left: auto; margin-right: auto;"> <thead> <tr> <th></th> <th>Particle Size</th> </tr> </thead> <tbody> <tr> <td><b>% Sand:</b></td> <td>2.0 - 0.05 mm</td> </tr> <tr> <td><b>% Silt:</b></td> <td>0.05 - 0.002 mm</td> </tr> <tr> <td><b>% Clay:</b></td> <td>&lt; 0.002 mm</td> </tr> </tbody> </table>			Particle Size	<b>% Sand:</b>	2.0 - 0.05 mm	<b>% Silt:</b>	0.05 - 0.002 mm	<b>% Clay:</b>	< 0.002 mm																												
	Particle Size																																				
<b>% Sand:</b>	2.0 - 0.05 mm																																				
<b>% Silt:</b>	0.05 - 0.002 mm																																				
<b>% Clay:</b>	< 0.002 mm																																				
<b>USDA Soil Textural Classification</b> Sand																																					

All results apply only to actual locations and materials tested. As a mutual protection to clients, the public and ourselves, all reports are submitted as the confidential property of clients, and authorization for publication of statements, conclusions or extracts from or regarding our reports is reserved pending our written approval.

**Comments:** \_\_\_\_\_  
 \_\_\_\_\_  
 \_\_\_\_\_

**Reviewed by:**   
 \_\_\_\_\_  
 Meghan Blodgett-Carrillo

# Direct Shear Test Results:

ASTM D-3080



Project: Q.C. - Lower Duwamish Waterway  
 Project Number: 21B233  
 Laboratory Sample ID: B21-1466  
 Sample Date: 7/9/2021  
 Test Date: 9/1/2021  
 Technician: M. Carrillo

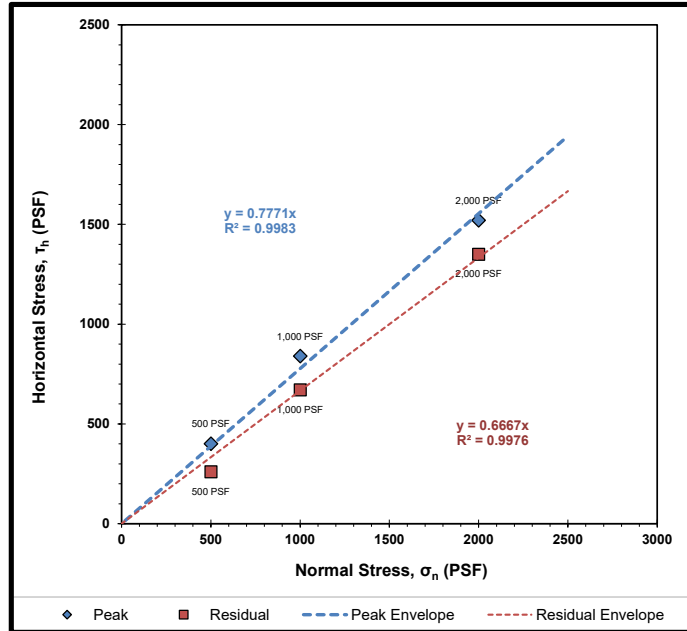
Sample Source: LDW21-GT7-GB-8.5-18.5 ft  
 Visual Soil Description: brown silty sand  
 Type of Specimen: Remolded Cylindrical Shear Box  
 Specimen Diameter (in): 2.5  
 Specimen Height (in): 1  
 Rate of Strain (in/min): 0.0208  
 Estimated Specific Gravity of Solids: 2.65

Summary of Sample Data: $\sigma_n=500$ PSF		
	Initial Moisture Content (%)	
	Initial	Post-Consolidation
Dry Density (PCF):	99.2	102.6
Void Ratio:	0.698	0.642
Porosity (%):	41.1	39.1
Degree of Saturation (%):	saturated	saturated

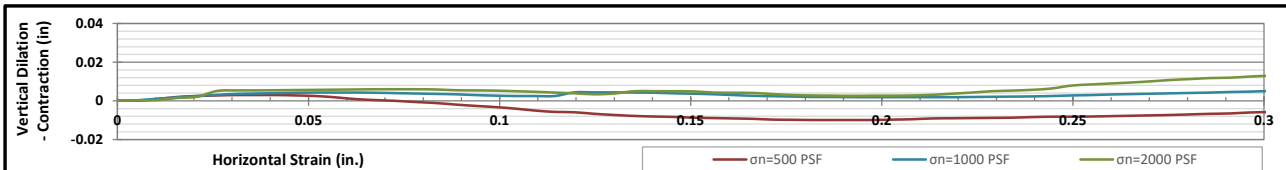
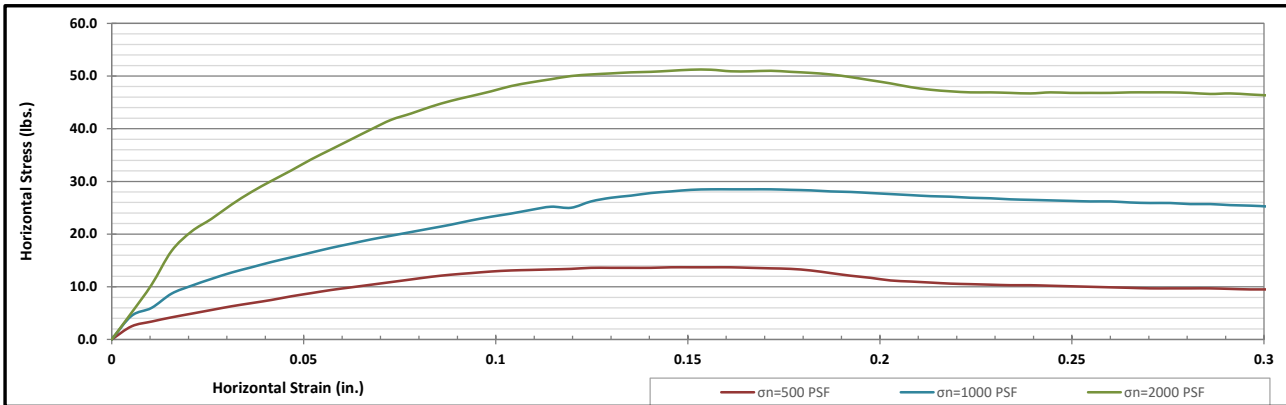
Summary of Sample Data: $\sigma_n=1000$ PSF		
	Initial Moisture Content (%)	
	Initial	Post-Consolidation
Dry Density (PCF):	97.5	105.0
Void Ratio:	0.728	0.605
Porosity (%):	42.1	37.7
Degree of Saturation (%):	saturated	saturated

Summary of Sample Data: $\sigma_n=2000$ PSF		
	Initial Moisture Content (%)	
	Initial	Post-Consolidation
Dry Density (PCF):	99.4	106.9
Void Ratio:	0.694	0.576
Porosity (%):	41.0	36.5
Degree of Saturation (%):	saturated	saturated

ESTIMATED STRENGTH PARAMETERS		
	PEAK	RESIDUAL
Angle of Internal Friction, $\phi$ (°):	38	34
Cohesion (PSF):	0	0



Failure Envelope Test Values:			
Normal Stress, $\sigma_n$ (PSF):	500	1000	2000
Peak Horizontal Stress, $\tau_h$ (PSF):	400	840	1520
Residual Horizontal Stress, $\tau_r$ (PSF):	260	670	1350



Corporate • 777 Chrysler Drive • Burlington, WA 98233 • Phone 360.755.1990 • Fax 360.755.1980  
 SW Region • 2118 Black Lake Blvd. S.W. • Olympia, WA 98512 • Phone 360.534.9777 • Fax 360.534.9779  
 NW Region • 805 Dupont, Suite #5 • Bellingham, WA 98225 • Phone 360.647.6061 • Fax 360.647.8111  
 Kitsap Region • 5451 N.W. Newberry Hill Road, Suite 101 • Silverdale, WA 98383 • Phone/Fax 360.698.6787

Visit our website: [www.mtc-inc.net](http://www.mtc-inc.net)



**Client:** Anchor QEA  
**Address:** 21328 2nd Drive SE  
Bothell, WA 98021  
**Attn:** Garrett Timm  
**Revised on:** \_\_\_\_\_

**Date:** September 30, 2021  
**Project:** Q.C. - Lower Duwamish Waterway  
**Project #:** 21B233  
**Sample #:** B21-1535-1552  
**Date sampled:** July 9, 2021

As requested MTC, Inc. has performed the following test(s) on the sample referenced above. The testing was performed in accordance with current applicable AASHTO or ASTM standards as indicated below. The results obtained in our laboratory were as follows below or on the attached pages:

	Test(s) Performed:	Test Results		Test(s) Performed:	Test Results
X	Sieve Analysis	Please See Attached Reports		Sulfate Soundness	
	Proctor			Bulk Density & Voids	
	Sand Equivalent			WSDOT Degradation	
	Fracture Count			LA Abrasion	
X	Moisture Content	Please See Attached Report	X	Direct Shear	Please See Attached Reports
	Specific Gravity, Coarse		X	Specific Gravity, Soils	Please See Attached Reports
	Specific Gravity, Fine				
X	Hydrometer Analysis	Please See Attached Reports			
X	Atterberg Limits	Please See Attached Reports			

If you have any questions concerning the test results, the procedures used, or if we can be of any further assistance please call on us at the number below.

Respectfully Submitted,  
 Meghan Blodgett-Carrillo  
 WABO Supervising Laboratory Technician



## Moisture Content - ASTM C566, ASTM D2216

**Project:** Q.C. - Lower Duwamish Waterway  
**Project #:** 21B233  
**Date Received:** July 29, 2021  
**Date Tested:** September 1, 2021

**Client:** Anchor QEA  
**Sampled by:** Client  
**Tested by:** A. Eifrig

Sample #	Location	Tare	Wet + Tare	Dry + Tare	Wgt. Of Moisture	Wgt. Of Soil	% Moisture
B21-1535	LDW21-GT7-GB-5.7-8.5 ft	220.0	955.7	691.6	264.1	471.6	56.0%
B21-1536	LDW21-GT7-GB-18.5-23.5 ft	233.7	1022.0	763.2	258.8	529.5	48.9%
B21-1537	LDW21-GT7-GB-23.5-25 ft	229.6	808.5	686.6	121.9	457.0	26.7%
B21-1538	LDW21-GT3-GB-0-1.5 ft	222.7	822.9	608.9	214.0	386.2	55.4%
B21-1539	LDW21-GT3-GB-0-8 ft	223.1	775.1	560.8	214.3	337.7	63.5%
B21-1540	LDW21-GT3-GB-8-9.5 ft	235.0	596.2	499.4	96.8	264.4	36.6%
B21-1541	LDW21-GT3-GB-13.6-18 ft	224.3	840.2	686.6	153.6	462.3	33.2%
B21-1542	LDW21-GT3-GB-18-19.5 ft	208.8	713.1	597.6	115.5	388.8	29.7%
B21-1543	LDW21-GT2-GB-0-1.5 ft	221.9	1015.5	706.7	308.8	484.8	63.7%
B21-1544	LDW21-GT2-GB-0-9 ft	221.9	1057.2	726.4	330.8	504.5	65.6%
B21-1545	LDW21-GT2-GB-9-10.5 ft	234.7	881.9	693.4	188.5	458.7	41.1%
B21-1546	LDW21-GT2-GB-16-19ft	319.9	776.4	594.5	181.9	274.6	66.2%
B21-1547	LDW21-GT1-GB-19-20.5 ft	268.9	932.1	798.3	133.8	529.4	25.3%
B21-1548	LDW21-GT1-GB-0-1.5 ft	270.2	991.8	734.1	257.7	463.9	55.6%
B21-1549	LDW21-GT1-GB-0-10 ft	266.5	951.7	694.7	257.0	428.2	60.0%
B21-1550	LDW21-GT1-GB-10-11.5 ft	303.8	1160.1	875.7	284.4	571.9	49.7%
B21-1551	LDW21-GT1-GB-10-20 ft	311.0	1013.9	756.9	257.0	445.9	57.6%
B21-1552	LDW21-GT1-GB-20-21.5 ft	306.5	1105.1	926.6	178.5	620.1	28.8%

All results apply only to actual locations and materials tested. As a mutual protection to clients, the public and ourselves, all reports are submitted as the confidential property of clients, and authorization for publication of statements, conclusions or extracts from or regarding our reports is reserved pending our written approval.

Reviewed by:   
 Meghan Blodgett-Carrillo





## ASTM D4318 - Liquid Limit, Plastic Limit and Plasticity Index of Soils

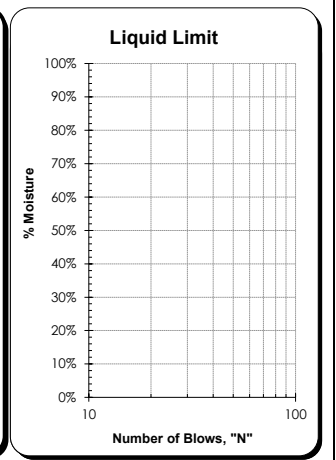
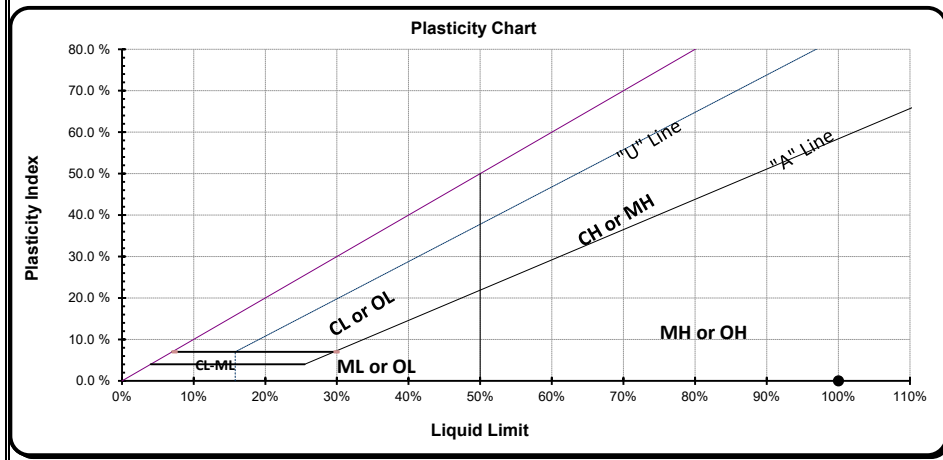
<b>Project:</b> Q.C. - Lower Duwamish Waterway <b>Project #:</b> 21B233 <b>Client:</b> Anchor QEA <b>Source:</b> LDW21-GT7-GB-5.7-8.5 ft <b>Sample #:</b> B21-1535	<b>Date Received:</b> 29-Jul-21 <b>Sampled By:</b> Client <b>Date Tested:</b> 1-Sep-21 <b>Tested By:</b> C. Kriss	<b>Visual Identification</b> Sand with Silt and Clay <b>Sample Color</b> brown
--	--	---

Liquid Limit Determination						
	#1	#2	#3	#4	#5	#6
Weight of Wet Soils + Pan:	34.38	32.59	32.44			
Weight of Dry Soils + Pan:	30.26	28.85	28.70			
Weight of Pan:	19.58	19.73	19.89			
Weight of Dry Soils:	10.68	9.12	8.81			
Weight of Moisture:	4.12	3.74	3.74			
% Moisture:	38.6 %	41.0 %	42.5 %			
Number of Blows:	33	24	13			



**Liquid Limit @ 25 Blows:** 40 %  
**Plastic Limit:** N/A  
**Plasticity Index, I<sub>p</sub>:** N/A

Plastic Limit Determination						
	#1	#2	#3	#4	#5	#6
Weight of Wet Soils + Pan:						
Weight of Dry Soils + Pan:	Plastic limit cannot be determined					
Weight of Pan:						
Weight of Dry Soils:						
Weight of Moisture:						
% Moisture:						



Copyright Spears Engineering & Technical Services PS, 1996-98  
 All results apply only to actual locations and materials tested. As a mutual protection to clients, the public and ourselves, all reports are submitted as the confidential property of clients, and authorization for publication of statements, conclusions or extracts from or regarding our reports is reserved pending our written approval.

**Comments:** Plastic limit cannot be determined as the material does not roll down to 1/8" threads before cracking or crumbling. Non-plastic.

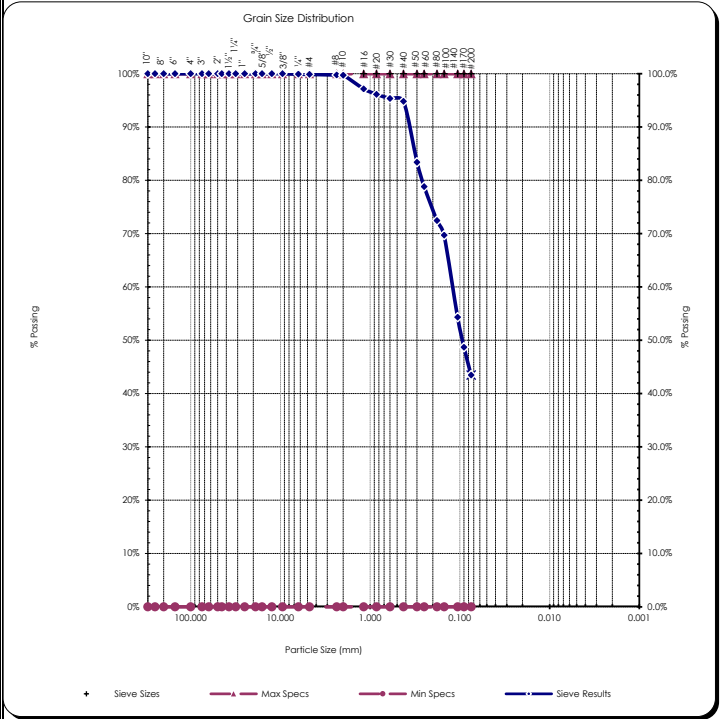
Reviewed by:   
 \_\_\_\_\_  
 Meghan Blodgett-Carrillo

# Sieve Report

<b>Project:</b> Q.C. - Lower Duwamish Waterway <b>Project #:</b> 21B233 <b>Client:</b> Anchor QEA <b>Source:</b> LDW21-GT7-GB-18.5-23.5 ft <b>Sample#:</b> B21-1536	<b>Date Received:</b> 29-Jul-21 <b>Sampled By:</b> Client <b>Date Tested:</b> 1-Sep-21 <b>Tested By:</b> C. Kriss	<b>Unified Soil Classification System, ASTM-2487</b> SM, Silty Sand <b>Sample Color:</b> brown	 Certificate #: 1366.01
---	--	---	----------------------------

<b>ASTM D2216, ASTM D2419, ASTM D4318, ASTM D5281</b>			
<b>Specifications</b> No Specs <b>Sample Meets Specs ?</b> N/A	D <sub>(5)</sub> = 0.009 mm D <sub>(10)</sub> = 0.017 mm D <sub>(15)</sub> = 0.026 mm D <sub>(30)</sub> = 0.052 mm D <sub>(50)</sub> = 0.094 mm D <sub>(60)</sub> = 0.122 mm D <sub>(90)</sub> = 0.372 mm Dust Ratio = 11/24	% Gravel = 0.1% % Sand = 56.4% % Silt & Clay = 43.5% Liquid Limit = 0.0% Plasticity Index = 0.0% Sand Equivalent = n/a Fracture %, 1 Face = n/a Fracture %, 2+ Faces = n/a	Coeff. of Curvature, C <sub>c</sub> = 1.27 Coeff. of Uniformity, C <sub>u</sub> = 7.08 Fineness Modulus = 0.55 Plastic Limit = 0.0% Moisture %, as sampled = 48.9% Req'd Sand Equivalent = Req'd Fracture %, 1 Face = Req'd Fracture %, 2+ Faces =

<b>ASTM C136, ASTM D6913, ASTM C117</b>					
Sieve Size		Actual Cumulative Percent Passing	Interpolated Cumulative Percent Passing	Specs Max	Specs Min
US	Metric				
12.00"	300.00		100%	100.0%	0.0%
10.00"	250.00		100%	100.0%	0.0%
8.00"	200.00		100%	100.0%	0.0%
6.00"	150.00		100%	100.0%	0.0%
4.00"	100.00		100%	100.0%	0.0%
3.00"	75.00		100%	100.0%	0.0%
2.50"	63.00		100%	100.0%	0.0%
2.00"	50.00	100%	100%	100.0%	0.0%
1.75"	45.00	100%	100%	100.0%	0.0%
1.50"	37.50	100%	100%	100.0%	0.0%
1.25"	31.50	100%	100%	100.0%	0.0%
1.00"	25.00	100%	100%	100.0%	0.0%
3/4"	19.00	100%	100%	100.0%	0.0%
5/8"	16.00	100%	100%	100.0%	0.0%
1/2"	12.50	100%	100%	100.0%	0.0%
3/8"	9.50	100%	100%	100.0%	0.0%
1/4"	6.30	100%	100%	100.0%	0.0%
#4	4.75	100%	100%	100.0%	0.0%
#8	2.36	100%	100%	100.0%	0.0%
#10	2.00	100%	100%	100.0%	0.0%
#16	1.18	97%	100%	100.0%	0.0%
#20	0.850	96%	100%	100.0%	0.0%
#30	0.600	95%	100%	100.0%	0.0%
#40	0.425	95%	100%	100.0%	0.0%
#50	0.300	83%	100%	100.0%	0.0%
#60	0.250	79%	100%	100.0%	0.0%
#80	0.180	72%	100%	100.0%	0.0%
#100	0.150	70%	100%	100.0%	0.0%
#140	0.106	54%	100%	100.0%	0.0%
#170	0.090	49%	100%	100.0%	0.0%
#200	0.075	43.5%	43.5%	100.0%	0.0%


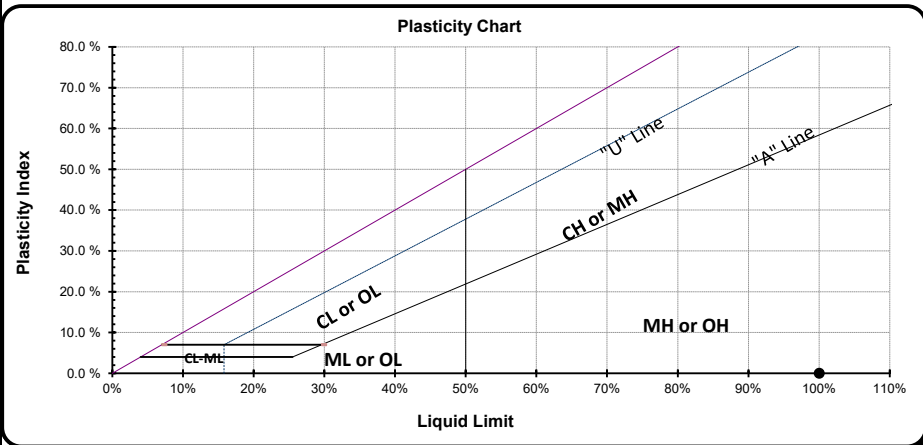
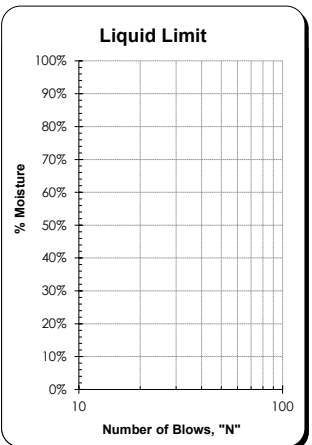


Copyright Spears Engineering & Technical Services PS, 1996-98  
 All results apply only to actual locations and materials tested. As a mutual protection to clients, the public and ourselves, all reports are submitted as the confidential property of clients, and authorization for publication of statements, conclusions or extracts from or regarding our reports is reserved pending our written approval.

**Comments:** \_\_\_\_\_


Reviewed by:   
 Meghan Blodgett-Carrillo

## ASTM D4318 - Liquid Limit, Plastic Limit and Plasticity Index of Soils

<b>Project:</b> Q.C. - Lower Duwamish Waterway <b>Project #:</b> 21B233 <b>Client:</b> Anchor QEA <b>Source:</b> LDW21-GT3-GB-0-8 ft <b>Sample #:</b> B21-1539	<b>Date Received:</b> 29-Jul-21 <b>Sampled By:</b> Client <b>Date Tested:</b> 1-Sep-21 <b>Tested By:</b> C. Kriss	<b>Visual Identification</b> Sandy Silt <b>Sample Color</b> brown																			
<b>Liquid Limit Determination</b>																					
<table border="1" style="width: 100%; border-collapse: collapse;"> <thead> <tr> <th></th> <th>#1</th> <th>#2</th> <th>#3</th> <th>#4</th> <th>#5</th> <th>#6</th> </tr> </thead> <tbody> <tr> <td>Weight of Wet Soils + Pan:</td> <td colspan="6" rowspan="6" style="background-color: yellow; text-align: center;">Liquid limit cannot be established</td> </tr> <tr> <td>Weight of Dry Soils + Pan:</td> </tr> <tr> <td>Weight of Pan:</td> </tr> <tr> <td>Weight of Dry Soils:</td> </tr> <tr> <td>Weight of Moisture:</td> </tr> <tr> <td>Number of Blows:</td> </tr> </tbody> </table>				#1	#2	#3	#4	#5	#6	Weight of Wet Soils + Pan:	Liquid limit cannot be established						Weight of Dry Soils + Pan:	Weight of Pan:	Weight of Dry Soils:	Weight of Moisture:	Number of Blows:
	#1	#2	#3	#4	#5	#6															
Weight of Wet Soils + Pan:	Liquid limit cannot be established																				
Weight of Dry Soils + Pan:																					
Weight of Pan:																					
Weight of Dry Soils:																					
Weight of Moisture:																					
Number of Blows:																					
<b>Plastic Limit Determination</b>																					
<table border="1" style="width: 100%; border-collapse: collapse;"> <thead> <tr> <th></th> <th>#1</th> <th>#2</th> <th>#3</th> <th>#4</th> <th>#5</th> <th>#6</th> </tr> </thead> <tbody> <tr> <td>Weight of Wet Soils + Pan:</td> <td colspan="6" rowspan="6" style="background-color: yellow; text-align: center;">Plastic limit cannot be determined</td> </tr> <tr> <td>Weight of Dry Soils + Pan:</td> </tr> <tr> <td>Weight of Pan:</td> </tr> <tr> <td>Weight of Dry Soils:</td> </tr> <tr> <td>Weight of Moisture:</td> </tr> <tr> <td>% Moisture:</td> </tr> </tbody> </table>				#1	#2	#3	#4	#5	#6	Weight of Wet Soils + Pan:	Plastic limit cannot be determined						Weight of Dry Soils + Pan:	Weight of Pan:	Weight of Dry Soils:	Weight of Moisture:	% Moisture:
	#1	#2	#3	#4	#5	#6															
Weight of Wet Soils + Pan:	Plastic limit cannot be determined																				
Weight of Dry Soils + Pan:																					
Weight of Pan:																					
Weight of Dry Soils:																					
Weight of Moisture:																					
% Moisture:																					
																					
<b>Liquid Limit @ 25 Blows:</b> N/A <b>Plastic Limit:</b> N/A <b>Plasticity Index, I<sub>p</sub>:</b> N/A																					
																					
																					

Copyright Spears Engineering & Technical Services PS, 1996-98  
 All results apply only to actual locations and materials tested. As a mutual protection to clients, the public and ourselves, all reports are submitted as the confidential property of clients, and authorization for publication of statements, conclusions or extracts from or regarding our reports is reserved pending our written approval.

**Comments:** Liquid limit cannot be established as the material displays rapid dilation upon spreading into the cup. At lower moistures the material does not spread into the liquid limit device without tearing the soil cake. Plastic limit cannot be determined as the material does not roll down to 1/8" threads before cracking or crumbling. Non-plastic.

Reviewed by:   
 Meghan Blodgett-Carrillo



# Sieve Report

<b>Project:</b> Q.C. - Lower Duwamish Waterway <b>Project #:</b> 21B233 <b>Client:</b> Anchor QEA <b>Source:</b> LDW21-GT3-GB-8-9.5 ft <b>Sample#:</b> B21-1540	<b>Date Received:</b> 29-Jul-21 <b>Sampled By:</b> Client <b>Date Tested:</b> 1-Sep-21 <b>Tested By:</b> C. Kriss	<b>Unified Soil Classification System, ASTM-2487</b> SM, Silty Sand <b>Sample Color:</b> brown	 Certificate #: 1366.01
---	--	---	----------------------------

**ASTM D2216, ASTM D2419, ASTM D4318, ASTM D5281**

**Specifications**

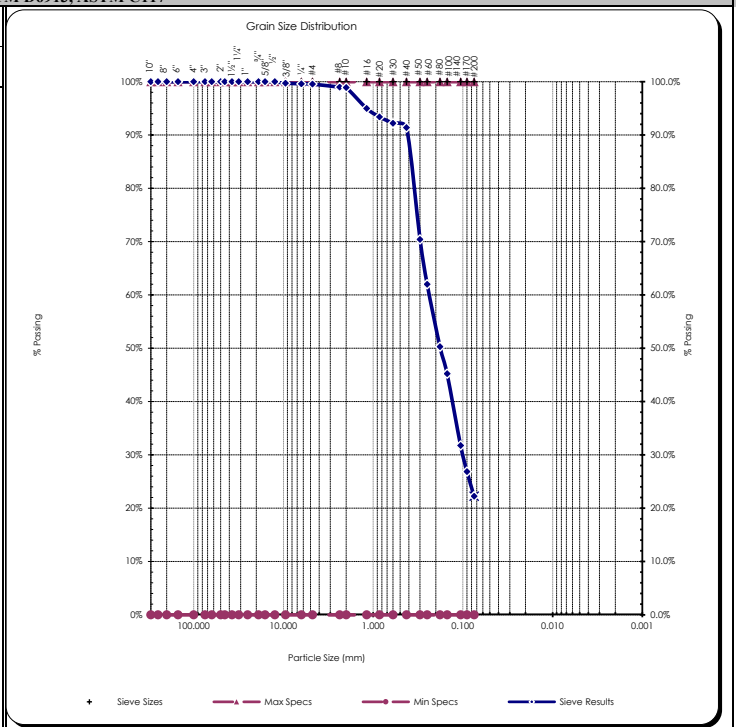
No Specs

Sample Meets Specs ? N/A

D <sub>(5)</sub> = 0.017 mm	% Gravel = 0.5%	Coeff. of Curvature, C <sub>c</sub> = 1.25
D <sub>(10)</sub> = 0.034 mm	% Sand = 77.3%	Coeff. of Uniformity, C <sub>u</sub> = 7.06
D <sub>(15)</sub> = 0.051 mm	% Silt & Clay = 22.3%	Fineness Modulus = 0.99
D <sub>(30)</sub> = 0.100 mm	Liquid Limit = 0.0%	Plastic Limit = 0.0%
D <sub>(50)</sub> = 0.178 mm	Plasticity Index = 0.0%	Moisture %, as sampled = 36.6%
D <sub>(60)</sub> = 0.238 mm	Sand Equivalent = n/a	Req'd Sand Equivalent =
D <sub>(90)</sub> = 0.417 mm	Fracture %, 1 Face = n/a	Req'd Fracture %, 1 Face =
Dust Ratio = 19/78	Fracture %, 2+ Faces = n/a	Req'd Fracture %, 2+ Faces =

**ASTM C136, ASTM D6913, ASTM C117**

Sieve Size		Actual Cumulative Percent Passing	Interpolated Cumulative Percent Passing	Specs Max	Specs Min
US	Metric				
12.00"	300.00		100%	100.0%	0.0%
10.00"	250.00		100%	100.0%	0.0%
8.00"	200.00		100%	100.0%	0.0%
6.00"	150.00		100%	100.0%	0.0%
4.00"	100.00		100%	100.0%	0.0%
3.00"	75.00		100%	100.0%	0.0%
2.50"	63.00		100%	100.0%	0.0%
2.00"	50.00	100%	100%	100.0%	0.0%
1.75"	45.00		100%	100.0%	0.0%
1.50"	37.50		100%	100.0%	0.0%
1.25"	31.50		100%	100.0%	0.0%
1.00"	25.00	100%	100%	100.0%	0.0%
3/4"	19.00	100%	100%	100.0%	0.0%
5/8"	16.00		100%	100.0%	0.0%
1/2"	12.50	100%	100%	100.0%	0.0%
3/8"	9.50	100%	100%	100.0%	0.0%
1/4"	6.30		100%	100.0%	0.0%
#4	4.75	100%	100%	100.0%	0.0%
#8	2.36		99%	100.0%	0.0%
#10	2.00	99%	99%	100.0%	0.0%
#16	1.18		95%	100.0%	0.0%
#20	0.850		93%	100.0%	0.0%
#30	0.600		92%	100.0%	0.0%
#40	0.425	91%	91%	100.0%	0.0%
#50	0.300		70%	100.0%	0.0%
#60	0.250		62%	100.0%	0.0%
#80	0.180		50%	100.0%	0.0%
#100	0.150	45%	45%	100.0%	0.0%
#140	0.106		32%	100.0%	0.0%
#170	0.090		27%	100.0%	0.0%
#200	0.075	22.3%	22.3%	100.0%	0.0%



Copyright Spears Engineering & Technical Services PS, 1996-98  
 All results apply only to actual locations and materials tested. As a mutual protection to clients, the public and ourselves, all reports are submitted as the confidential property of clients, and authorization for publication of statements, conclusions or extracts from or regarding our reports is reserved pending our written approval.

**Comments:** \_\_\_\_\_

Reviewed by:   
 Meghan Blodgett-Carrillo

# Direct Shear Test Results:

ASTM D-3080



Project: Q.C. - Lower Duwamish Waterway  
 Project Number: 21B233  
 Laboratory Sample ID: B21-1540  
 Sample Date: 7/9/2021  
 Test Date: 9/24/2021  
 Technician: M. Carrillo

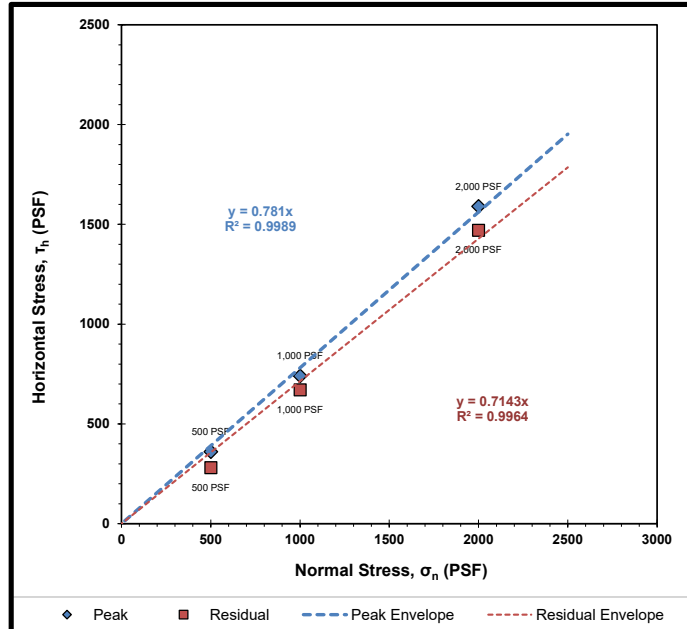
Sample Source: LDW21-GT3-GB-8-9.5 ft  
 Visual Soil Description: brown silty sand  
 Type of Specimen: Remolded Cylindrical Shear Box  
 Specimen Diameter (in): 2.5  
 Specimen Height (in): 1  
 Rate of Strain (in/min): 0.0208  
 Estimated Specific Gravity of Solids: 2.65

Summary of Sample Data: $\sigma_n=500$ PSF		
Initial Moisture Content (%)	33.7	
	Initial	Post-Consolidation
Dry Density (PCF):	102.4	104.0
Void Ratio:	0.645	0.620
Porosity (%):	39.2	38.3
Degree of Saturation (%):	saturated	saturated

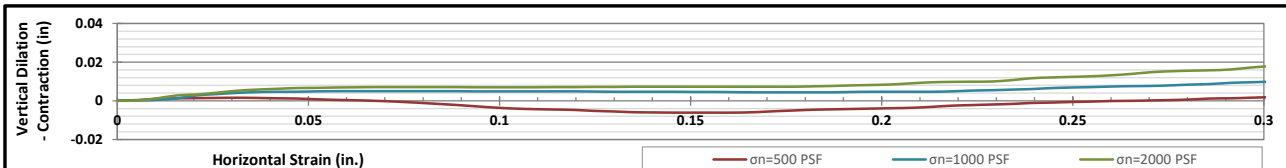
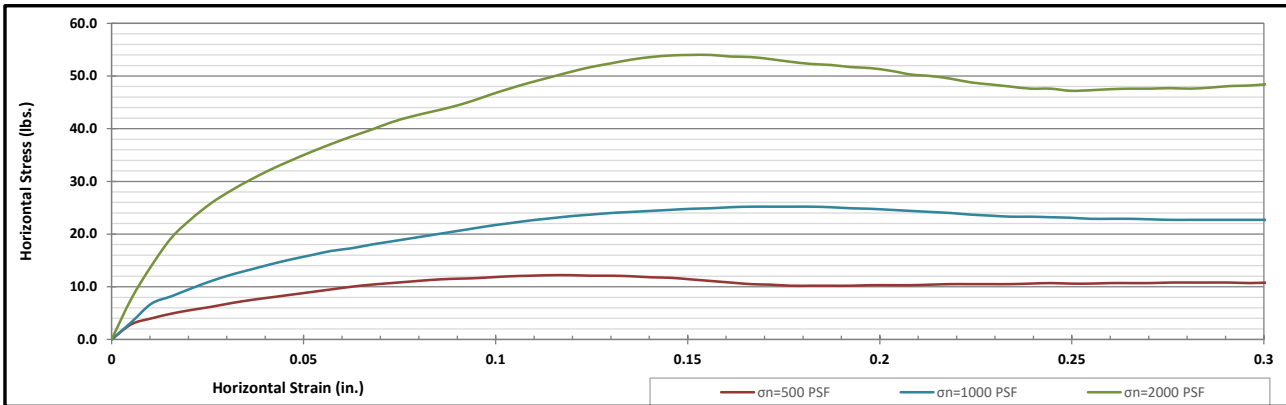
Summary of Sample Data: $\sigma_n=1000$ PSF		
Initial Moisture Content (%)	31.2	
	Initial	Post-Consolidation
Dry Density (PCF):	104.0	109.1
Void Ratio:	0.620	0.544
Porosity (%):	38.3	35.2
Degree of Saturation (%):	saturated	saturated

Summary of Sample Data: $\sigma_n=2000$ PSF		
Initial Moisture Content (%)	30.1	
	Initial	Post-Consolidation
Dry Density (PCF):	105.0	110.4
Void Ratio:	0.605	0.526
Porosity (%):	37.7	34.5
Degree of Saturation (%):	saturated	saturated

ESTIMATED STRENGTH PARAMETERS		
	PEAK	RESIDUAL
Angle of Internal Friction, $\phi$ (°):	38	36
Cohesion (PSF):	0	0



Failure Envelope Test Values:			
Normal Stress, $\sigma_n$ (PSF):	500	1000	2000
Peak Horizontal Stress, $\tau_h$ (PSF):	360	740	1590
Residual Horizontal Stress, $\tau_r$ (PSF):	280	670	1470



Corporate • 777 Chrysler Drive • Burlington, WA 98233 • Phone 360.755.1990 • Fax 360.755.1980  
 SW Region • 2118 Black Lake Blvd. S.W. • Olympia, WA 98512 • Phone 360.534.9777 • Fax 360.534.9779  
 NW Region • 805 Dupont, Suite #5 • Bellingham, WA 98225 • Phone 360.647.6061 • Fax 360.647.8111  
 Kitsap Region • 5451 N.W. Newberry Hill Road, Suite 101 • Silverdale, WA 98383 • Phone/Fax 360.698.6787

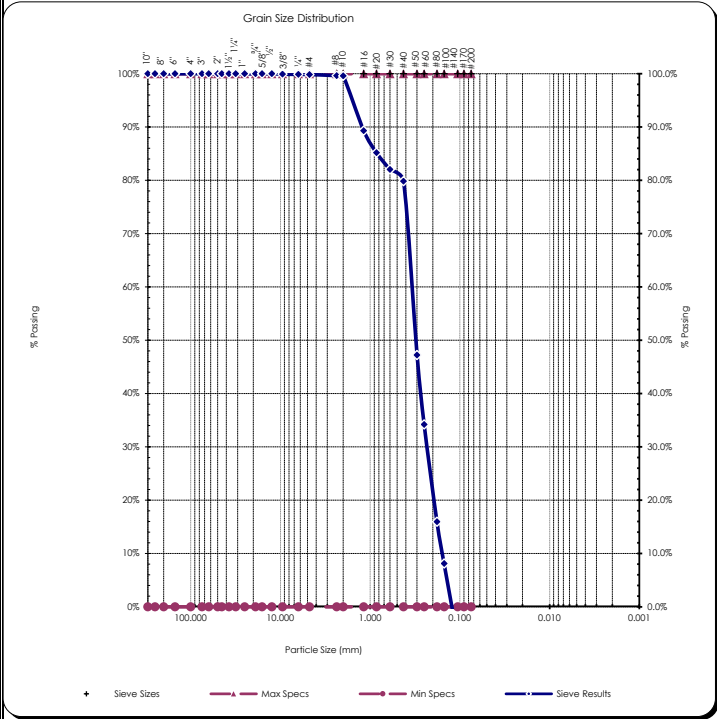
Visit our website: [www.mtc-inc.net](http://www.mtc-inc.net)

# Sieve Report

<b>Project:</b> Q.C. - Lower Duwamish Waterway <b>Project #:</b> 21B233 <b>Client:</b> Anchor QEA <b>Source:</b> LDW21-GT3-GB-13.6-18 ft <b>Sample#:</b> B21-1541	<b>Date Received:</b> 29-Jul-21 <b>Sampled By:</b> Client <b>Date Tested:</b> 1-Sep-21 <b>Tested By:</b> C. Kriss	<b>Unified Soil Classification System, ASTM-2487</b> SP, Poorly graded Sand <b>Sample Color:</b> brown	 Certificate #: 1366.01
---	--	---	----------------------------

<b>ASTM D2216, ASTM D2419, ASTM D4318, ASTM D5281</b>			
<b>Specifications</b> No Specs <b>Sample Meets Specs ?</b> N/A	D <sub>(5)</sub> = 0.140 mm D <sub>(10)</sub> = 0.157 mm D <sub>(15)</sub> = 0.176 mm D <sub>(30)</sub> = 0.234 mm D <sub>(50)</sub> = 0.311 mm D <sub>(60)</sub> = 0.349 mm D <sub>(90)</sub> = 1.234 mm Dust Ratio = - 17/89	% Gravel = 0.2% % Sand = 115.1% % Silt & Clay = -15.2% Liquid Limit = n/a Plasticity Index = n/a Sand Equivalent = n/a Fracture %, 1 Face = n/a Fracture %, 2+ Faces = n/a	Coeff. of Curvature, C <sub>c</sub> = 1.00 Coeff. of Uniformity, C <sub>u</sub> = 2.22 Fineness Modulus = 1.74 Plastic Limit = n/a Moisture %, as sampled = 33.2% Req'd Sand Equivalent = Req'd Fracture %, 1 Face = Req'd Fracture %, 2+ Faces =

<b>ASTM C136, ASTM D6913, ASTM C117</b>					
Sieve Size		Actual Cumulative Percent Passing	Interpolated Cumulative Percent Passing	Specs Max	Specs Min
US	Metric				
12.00"	300.00		100%	100.0%	0.0%
10.00"	250.00		100%	100.0%	0.0%
8.00"	200.00		100%	100.0%	0.0%
6.00"	150.00		100%	100.0%	0.0%
4.00"	100.00		100%	100.0%	0.0%
3.00"	75.00		100%	100.0%	0.0%
2.50"	63.00		100%	100.0%	0.0%
2.00"	50.00	100%	100%	100.0%	0.0%
1.75"	45.00	100%	100%	100.0%	0.0%
1.50"	37.50	100%	100%	100.0%	0.0%
1.25"	31.50	100%	100%	100.0%	0.0%
1.00"	25.00	100%	100%	100.0%	0.0%
3/4"	19.00	100%	100%	100.0%	0.0%
5/8"	16.00	100%	100%	100.0%	0.0%
1/2"	12.50	100%	100%	100.0%	0.0%
3/8"	9.50	100%	100%	100.0%	0.0%
1/4"	6.30	100%	100%	100.0%	0.0%
#4	4.75	100%	100%	100.0%	0.0%
#8	2.36	100%	100%	100.0%	0.0%
#10	2.00	100%	100%	100.0%	0.0%
#16	1.18	89%	89%	100.0%	0.0%
#20	0.850	85%	85%	100.0%	0.0%
#30	0.600	80%	82%	100.0%	0.0%
#40	0.425	80%	80%	100.0%	0.0%
#50	0.300	47%	47%	100.0%	0.0%
#60	0.250	34%	34%	100.0%	0.0%
#80	0.180	16%	16%	100.0%	0.0%
#100	0.150	8%	8%	100.0%	0.0%
#140	0.106	-6%	-6%	100.0%	0.0%
#170	0.090	-11%	-11%	100.0%	0.0%
#200	0.075	-15.2%	-15.2%	100.0%	0.0%



Copyright Spears Engineering & Technical Services PS, 1996-98

**Comments:** \_\_\_\_\_

Reviewed by:   
 Meghan Blodgett-Carrillo

## ASTM D4318 - Liquid Limit, Plastic Limit and Plasticity Index of Soils

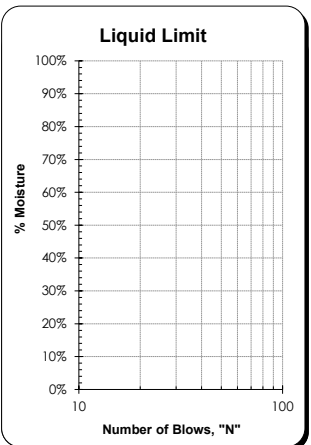
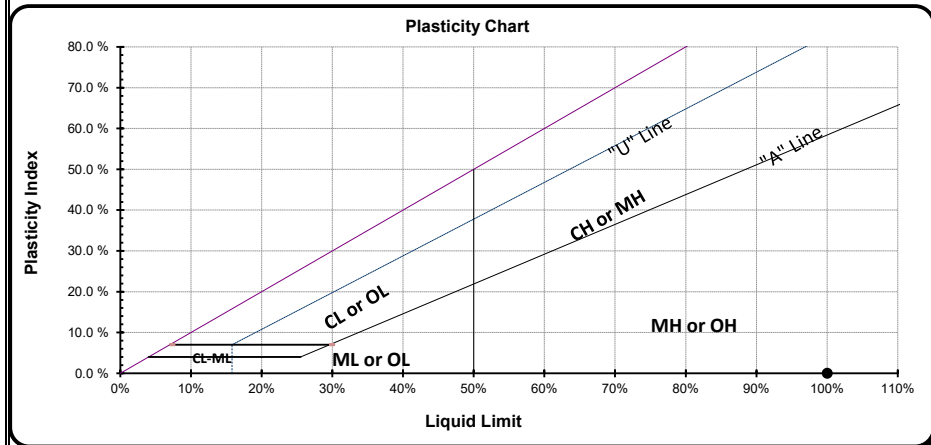
<b>Project:</b> Q.C. - Lower Duwamish Waterway <b>Project #:</b> 21B233 <b>Client:</b> Anchor QEA <b>Source:</b> LDW21-GT2-GB-0-9 ft <b>Sample #:</b> B21-1544	<b>Date Received:</b> 29-Jul-21 <b>Sampled By:</b> Client <b>Date Tested:</b> 1-Sep-21 <b>Tested By:</b> C. Kriss	<b>Visual Identification</b> Sandy Silt <b>Sample Color</b> brown
--	--	--

Liquid Limit Determination						
	#1	#2	#3	#4	#5	#6
Weight of Wet Soils + Pan:	Liquid limit cannot be established					
Weight of Dry Soils + Pan:						
Weight of Pan:						
Weight of Dry Soils:						
Weight of Moisture:						
% Moisture:						
Number of Blows:						



**Liquid Limit @ 25 Blows:** N/A  
**Plastic Limit:** N/A  
**Plasticity Index, I<sub>p</sub>:** N/A

Plastic Limit Determination						
	#1	#2	#3	#4	#5	#6
Weight of Wet Soils + Pan:	Plastic limit cannot be determined					
Weight of Dry Soils + Pan:						
Weight of Pan:						
Weight of Dry Soils:						
Weight of Moisture:						
% Moisture:						



Copyright Spears Engineering & Technical Services PS, 1996-98  
 All results apply only to actual locations and materials tested. As a mutual protection to clients, the public and ourselves, all reports are submitted as the confidential property of clients, and authorization for publication of statements, conclusions or extracts from or regarding our reports is reserved pending our written approval.

**Comments:** Liquid limit cannot be established as the material displays rapid dilation upon spreading into the cup. At lower moistures the material does not spread into the liquid limit device without tearing the soil cake. Plastic limit cannot be determined as the material does not roll down to 1/8" threads before cracking or crumbling. Non-plastic.

Reviewed by:   
 \_\_\_\_\_  
 Meghan Blodgett-Carrillo

# Sieve Report

<b>Project:</b> Q.C. - Lower Duwamish Waterway <b>Project #:</b> 21B233 <b>Client:</b> Anchor QEA <b>Source:</b> LDW21-GT2-GB-16-19 ft <b>Sample#:</b> B21-1546	<b>Date Received:</b> 29-Jul-21 <b>Sampled By:</b> Client <b>Date Tested:</b> 1-Sep-21 <b>Tested By:</b> C. Kriss	<b>Visual Identification</b> Sandy Silt with Clay <b>Sample Color:</b> brown
---	--	---



**ASTM D2216, ASTM D2419, ASTM D4318, ASTM D5281**

**Specifications**

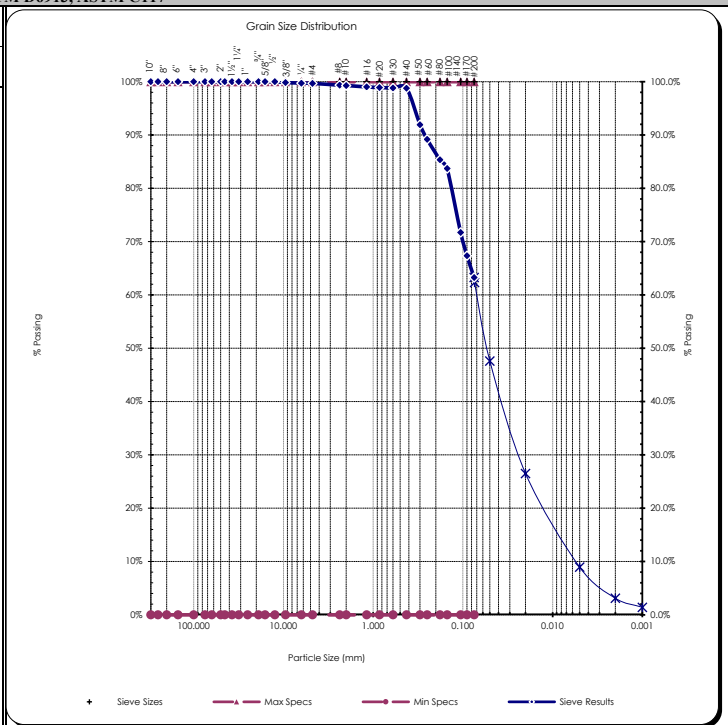
No Specs

Sample Meets Specs ? **N/A**

$D_{(5)} = 0.003$ mm $D_{(10)} = 0.006$ mm $D_{(15)} = 0.009$ mm $D_{(30)} = 0.025$ mm $D_{(50)} = 0.061$ mm $D_{(60)} = 0.072$ mm $D_{(90)} = 0.265$ mm Dust Ratio = 25/39	% Gravel = 0.3% % Sand = 36.4% % Silt & Clay = 63.3% Liquid Limit = n/a Plasticity Index = n/a Sand Equivalent = n/a Fracture %, 1 Face = n/a Fracture %, 2+ Faces = n/a	Coeff. of Curvature, $C_c = 1.57$ Coeff. of Uniformity, $C_u = 12.88$ Fineness Modulus = 0.28 Plastic Limit = n/a Moisture %, as sampled = 66.2% Req'd Sand Equivalent = Req'd Fracture %, 1 Face = Req'd Fracture %, 2+ Faces =
--	---	---

**ASTM C136, ASTM D6913, ASTM C117**

Sieve Size		Actual Cumulative Percent Passing	Interpolated Cumulative Percent Passing	Specs Max	Specs Min
US	Metric				
12.00"	300.00		100%	100.0%	0.0%
10.00"	250.00		100%	100.0%	0.0%
8.00"	200.00		100%	100.0%	0.0%
6.00"	150.00		100%	100.0%	0.0%
4.00"	100.00		100%	100.0%	0.0%
3.00"	75.00		100%	100.0%	0.0%
2.50"	63.00		100%	100.0%	0.0%
2.00"	50.00	100%	100%	100.0%	0.0%
1.75"	45.00		100%	100.0%	0.0%
1.50"	37.50		100%	100.0%	0.0%
1.25"	31.50		100%	100.0%	0.0%
1.00"	25.00	100%	100%	100.0%	0.0%
3/4"	19.00	100%	100%	100.0%	0.0%
5/8"	16.00		100%	100.0%	0.0%
1/2"	12.50	100%	100%	100.0%	0.0%
3/8"	9.50	100%	100%	100.0%	0.0%
1/4"	6.30		100%	100.0%	0.0%
#4	4.75	100%	100%	100.0%	0.0%
#8	2.36		99%	100.0%	0.0%
#10	2.00	99%	99%	100.0%	0.0%
#16	1.18		99%	100.0%	0.0%
#20	0.850		99%	100.0%	0.0%
#30	0.600		99%	100.0%	0.0%
#40	0.425	99%	99%	100.0%	0.0%
#50	0.300		92%	100.0%	0.0%
#60	0.250		89%	100.0%	0.0%
#80	0.180		85%	100.0%	0.0%
#100	0.150	84%	84%	100.0%	0.0%
#140	0.106		72%	100.0%	0.0%
#170	0.090		67%	100.0%	0.0%
#200	0.075	63.3%	63.3%	100.0%	0.0%



Copyright Spears Engineering & Technical Services PS, 1996-98

All results apply only to actual locations and materials tested. As a mutual protection to clients, the public and ourselves, all reports are submitted as the confidential property of clients, and authorization for publication of statements, conclusions or extracts from or regarding our reports is reserved pending our written approval.

**Comments:**

Reviewed by:   
 Meghan Blodgett-Carrillo



## Hydrometer Report

<b>Project:</b> Q.C. - Lower Duwamish Waterway <b>Project #:</b> 21B233 <b>Client:</b> Anchor QEA <b>Source:</b> LDW21-GT2-GB-16-19 ft <b>Sample#:</b> B21-1546	<b>Date Received:</b> 29-Jul-21 <b>Sampled By:</b> Client <b>Date Tested:</b> 1-Sep-21 <b>Tested By:</b> C. Kriss	<b>Visual Identification</b> Sandy Silt with Clay <b>Sample Color</b> brown																																																																																																									
<b>ASTM D7928, HYDROMETER ANALYSIS</b>		<b>ASTM D6913</b>																																																																																																									
Sp Gr : 2.54 Sample Weight: 75.85 grams Hydroscopic Moist.: 6.24% Adj. Sample Wgt : 71.39 grams		<b>Sieve Analysis</b> <b>Grain Size Distribution</b>																																																																																																									
<table border="1" style="width: 100%; border-collapse: collapse;"> <thead> <tr> <th>Hydrometer Reading Minutes</th> <th>Corrected Reading</th> <th>Percent Passing</th> <th>Soils Particle Diameter</th> </tr> </thead> <tbody> <tr><td>1</td><td>27</td><td>38.7%</td><td>0.0494 mm</td></tr> <tr><td>2</td><td>23.5</td><td>33.7%</td><td>0.0358 mm</td></tr> <tr><td>5</td><td>20.5</td><td>29.4%</td><td>0.0231 mm</td></tr> <tr><td>15</td><td>14.5</td><td>20.8%</td><td>0.0138 mm</td></tr> <tr><td>30</td><td>11.5</td><td>16.5%</td><td>0.0099 mm</td></tr> <tr><td>60</td><td>9</td><td>12.9%</td><td>0.0071 mm</td></tr> <tr><td>240</td><td>4.5</td><td>6.4%</td><td>0.0036 mm</td></tr> <tr><td>1440</td><td>1.5</td><td>2.1%</td><td>0.0015 mm</td></tr> </tbody> </table> <p>                 % Gravel: 0.3%                      <b>Liquid Limit:</b> n/a                  % Sand: 36.4%                      <b>Plastic Limit:</b> n/a                  % Silt: 54.3%                      <b>Plasticity Index:</b> n/a                  % Clay: 9.0%             </p>	Hydrometer Reading Minutes	Corrected Reading	Percent Passing	Soils Particle Diameter	1	27	38.7%	0.0494 mm	2	23.5	33.7%	0.0358 mm	5	20.5	29.4%	0.0231 mm	15	14.5	20.8%	0.0138 mm	30	11.5	16.5%	0.0099 mm	60	9	12.9%	0.0071 mm	240	4.5	6.4%	0.0036 mm	1440	1.5	2.1%	0.0015 mm	<table border="1" style="width: 100%; border-collapse: collapse;"> <thead> <tr> <th>Sieve Size</th> <th>Percent Passing</th> <th>Soils Particle Diameter</th> </tr> </thead> <tbody> <tr><td>3.0"</td><td>100%</td><td>75.000 mm</td></tr> <tr><td>2.0"</td><td>100%</td><td>50.000 mm</td></tr> <tr><td>1.5"</td><td>100%</td><td>37.500 mm</td></tr> <tr><td>1.25"</td><td>100%</td><td>31.500 mm</td></tr> <tr><td>1.0"</td><td>100%</td><td>25.000 mm</td></tr> <tr><td>3/4"</td><td>100%</td><td>19.000 mm</td></tr> <tr><td>5/8"</td><td>100%</td><td>16.000 mm</td></tr> <tr><td>1/2"</td><td>100%</td><td>12.500 mm</td></tr> <tr><td>3/8"</td><td>100%</td><td>9.500 mm</td></tr> <tr><td>1/4"</td><td>100%</td><td>6.300 mm</td></tr> <tr><td>#4</td><td>100%</td><td>4.750 mm</td></tr> <tr><td>#10</td><td>99%</td><td>2.000 mm</td></tr> <tr><td>#20</td><td>99%</td><td>0.850 mm</td></tr> <tr><td>#40</td><td>99%</td><td>0.425 mm</td></tr> <tr><td>#100</td><td>84%</td><td>0.150 mm</td></tr> <tr><td>#200</td><td>63.3%</td><td>0.075 mm</td></tr> <tr><td><b>Silts</b></td><td>62.3%</td><td>0.074 mm</td></tr> <tr><td></td><td>47.6%</td><td>0.050 mm</td></tr> <tr><td></td><td>26.5%</td><td>0.020 mm</td></tr> <tr><td><b>Clays</b></td><td>9.0%</td><td>0.005 mm</td></tr> <tr><td></td><td>3.1%</td><td>0.002 mm</td></tr> <tr><td><b>Colloids</b></td><td>1.4%</td><td>0.001 mm</td></tr> </tbody> </table>		Sieve Size	Percent Passing	Soils Particle Diameter	3.0"	100%	75.000 mm	2.0"	100%	50.000 mm	1.5"	100%	37.500 mm	1.25"	100%	31.500 mm	1.0"	100%	25.000 mm	3/4"	100%	19.000 mm	5/8"	100%	16.000 mm	1/2"	100%	12.500 mm	3/8"	100%	9.500 mm	1/4"	100%	6.300 mm	#4	100%	4.750 mm	#10	99%	2.000 mm	#20	99%	0.850 mm	#40	99%	0.425 mm	#100	84%	0.150 mm	#200	63.3%	0.075 mm	<b>Silts</b>	62.3%	0.074 mm		47.6%	0.050 mm		26.5%	0.020 mm	<b>Clays</b>	9.0%	0.005 mm		3.1%	0.002 mm	<b>Colloids</b>	1.4%	0.001 mm
Hydrometer Reading Minutes	Corrected Reading	Percent Passing	Soils Particle Diameter																																																																																																								
1	27	38.7%	0.0494 mm																																																																																																								
2	23.5	33.7%	0.0358 mm																																																																																																								
5	20.5	29.4%	0.0231 mm																																																																																																								
15	14.5	20.8%	0.0138 mm																																																																																																								
30	11.5	16.5%	0.0099 mm																																																																																																								
60	9	12.9%	0.0071 mm																																																																																																								
240	4.5	6.4%	0.0036 mm																																																																																																								
1440	1.5	2.1%	0.0015 mm																																																																																																								
Sieve Size	Percent Passing	Soils Particle Diameter																																																																																																									
3.0"	100%	75.000 mm																																																																																																									
2.0"	100%	50.000 mm																																																																																																									
1.5"	100%	37.500 mm																																																																																																									
1.25"	100%	31.500 mm																																																																																																									
1.0"	100%	25.000 mm																																																																																																									
3/4"	100%	19.000 mm																																																																																																									
5/8"	100%	16.000 mm																																																																																																									
1/2"	100%	12.500 mm																																																																																																									
3/8"	100%	9.500 mm																																																																																																									
1/4"	100%	6.300 mm																																																																																																									
#4	100%	4.750 mm																																																																																																									
#10	99%	2.000 mm																																																																																																									
#20	99%	0.850 mm																																																																																																									
#40	99%	0.425 mm																																																																																																									
#100	84%	0.150 mm																																																																																																									
#200	63.3%	0.075 mm																																																																																																									
<b>Silts</b>	62.3%	0.074 mm																																																																																																									
	47.6%	0.050 mm																																																																																																									
	26.5%	0.020 mm																																																																																																									
<b>Clays</b>	9.0%	0.005 mm																																																																																																									
	3.1%	0.002 mm																																																																																																									
<b>Colloids</b>	1.4%	0.001 mm																																																																																																									
<b>USDA Soil Textural Classification</b>																																																																																																											
% Sand: 36.4% % Silt: 54.3% % Clay: 9.0%	Particle Size 2.0 - 0.05 mm 0.05 - 0.002 mm < 0.002 mm																																																																																																										
<b>USDA Soil Textural Classification</b>																																																																																																											
Sandy Loam																																																																																																											

All results apply only to actual locations and materials tested. As a mutual protection to clients, the public and ourselves, all reports are submitted as the confidential property of clients, and authorization for publication of statements, conclusions or extracts from or regarding our reports is reserved pending our written approval.

**Comments:** \_\_\_\_\_

\_\_\_\_\_

\_\_\_\_\_

**Reviewed by:** \_\_\_\_\_  
 Meghan Blodgett-Carrillo

# Direct Shear Test Results:

ASTM D-3080



Project: Q.C. - Lower Duwamish Waterway  
 Project Number: 21B233  
 Laboratory Sample ID: B21-1546  
 Sample Date: 7/9/2021  
 Test Date: 9/27/2021  
 Technician: M. Carrillo

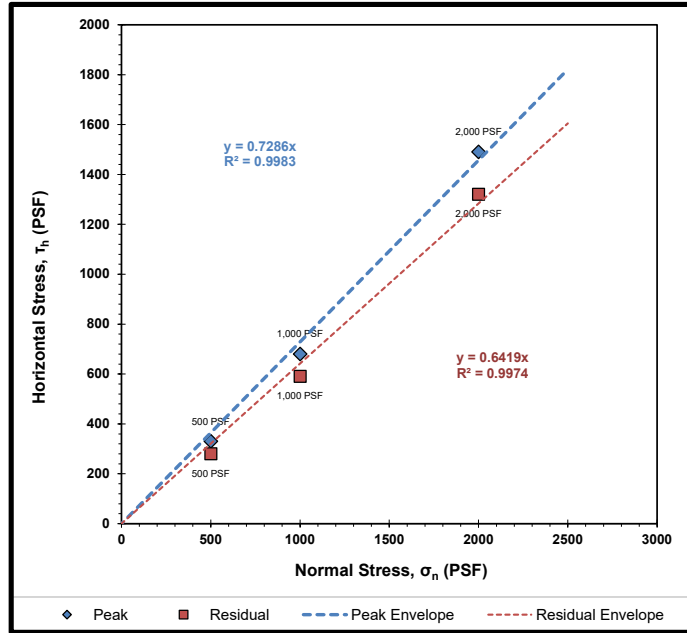
Sample Source: LDW21-GT2-GB-16-19 ft  
 Visual Soil Description: brown sandy silt  
 Type of Specimen: Remolded Cylindrical Shear Box  
 Specimen Diameter (in): 2.5  
 Specimen Height (in): 1  
 Rate of Strain (in/min): 0.0042  
 Estimated Specific Gravity of Solids: 2.65

Summary of Sample Data: $\sigma_n=500$ PSF		
Initial Moisture Content (%):	38.6	
	Initial	Post-Consolidation
Dry Density (PCF):	100.0	106.5
Void Ratio:	0.684	0.581
Porosity (%):	40.6	36.8
Degree of Saturation (%):	saturated	saturated

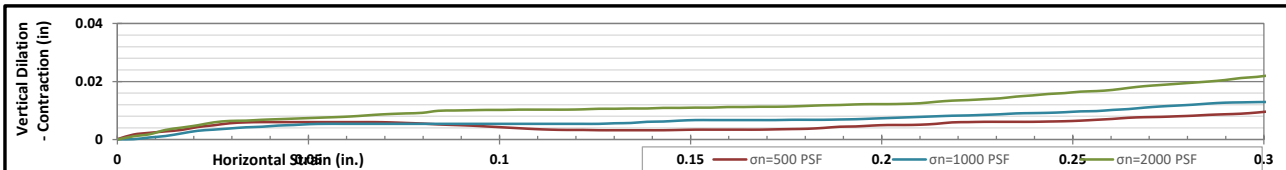
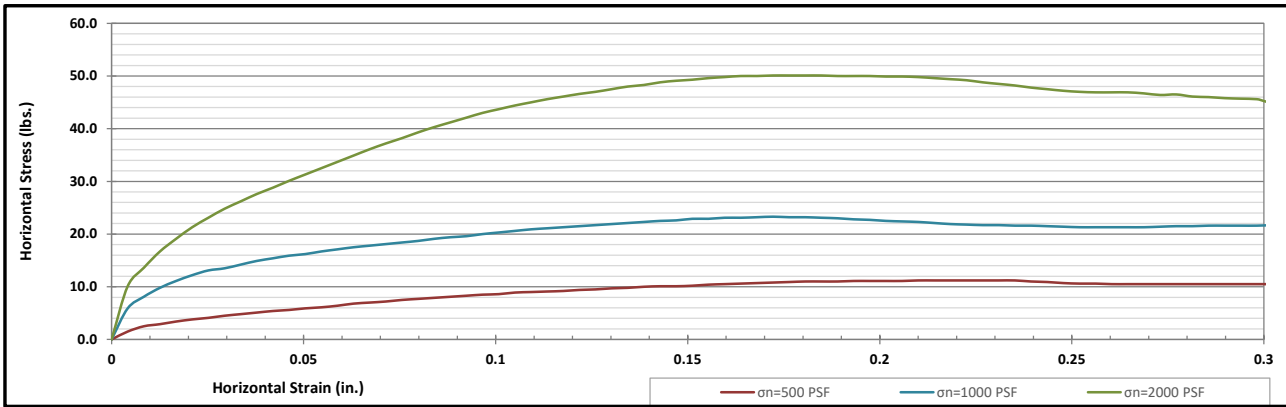
Summary of Sample Data: $\sigma_n=1000$ PSF		
Initial Moisture Content (%):	36.2	
	Initial	Post-Consolidation
Dry Density (PCF):	101.4	111.3
Void Ratio:	0.661	0.514
Porosity (%):	39.8	34.0
Degree of Saturation (%):	saturated	saturated

Summary of Sample Data: $\sigma_n=2000$ PSF		
Initial Moisture Content (%):	34.6	
	Initial	Post-Consolidation
Dry Density (PCF):	102.5	110.5
Void Ratio:	0.643	0.525
Porosity (%):	39.1	34.4
Degree of Saturation (%):	saturated	saturated

ESTIMATED STRENGTH PARAMETERS		
	PEAK	RESIDUAL
Angle of Internal Friction, $\phi$ (°):	36	33
Cohesion (PSF):	0	0



Failure Envelope Test Values:			
Normal Stress, $\sigma_n$ (PSF):	500	1000	2000
Peak Horizontal Stress, $\tau_h$ (PSF):	330	680	1490
Residual Horizontal Stress, $\tau_h$ (PSF):	280	590	1320



Corporate • 777 Chrysler Drive • Burlington, WA 98233 • Phone 360.755.1990 • Fax 360.755.1980  
 SW Region • 2118 Black Lake Blvd. S.W. • Olympia, WA 98512 • Phone 360.534.9777 • Fax 360.534.9779  
 NW Region • 805 Dupont, Suite #5 • Bellingham, WA 98225 • Phone 360.647.6061 • Fax 360.647.8111  
 Kitsap Region • 5451 N.W. Newberry Hill Road, Suite 101 • Silverdale, WA 98383 • Phone/Fax 360.698.6787

Visit our website: [www.mtc-inc.net](http://www.mtc-inc.net)

## ASTM D4318 - Liquid Limit, Plastic Limit and Plasticity Index of Soils

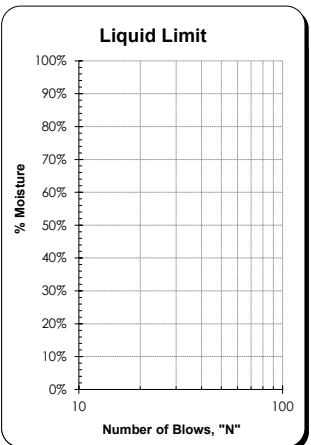
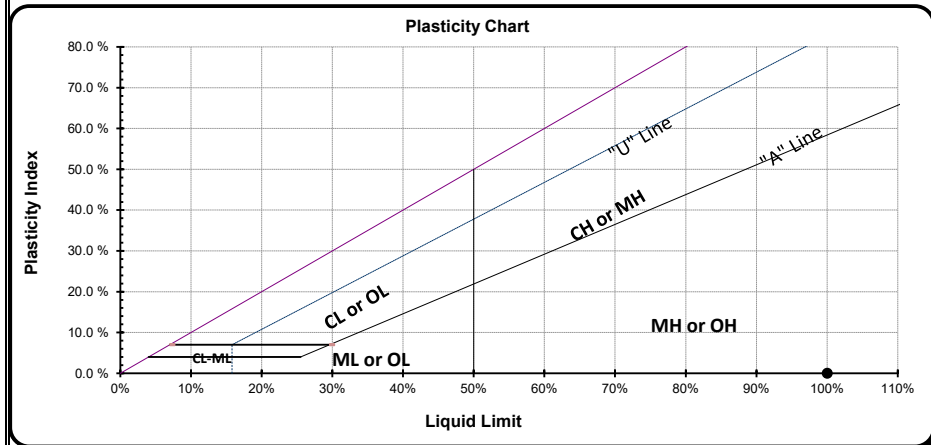
<b>Project:</b> Q.C. - Lower Duwamish Waterway <b>Project #:</b> 21B233 <b>Client:</b> Anchor QEA <b>Source:</b> LDW21-GT1-GB-0-10 ft <b>Sample #:</b> B21-1549	<b>Date Received:</b> 29-Jul-21 <b>Sampled By:</b> Client <b>Date Tested:</b> 1-Sep-21 <b>Tested By:</b> C. Kriss	<b>Visual Identification</b> Silty Sand <b>Sample Color</b> brown
---	--	--

Liquid Limit Determination						
	#1	#2	#3	#4	#5	#6
Weight of Wet Soils + Pan:	Liquid limit cannot be established					
Weight of Dry Soils + Pan:						
Weight of Pan:						
Weight of Dry Soils:						
Weight of Moisture:						
% Moisture:						
Number of Blows:						



**Liquid Limit @ 25 Blows:** N/A  
**Plastic Limit:** N/A  
**Plasticity Index, I<sub>p</sub>:** N/A

Plastic Limit Determination						
	#1	#2	#3	#4	#5	#6
Weight of Wet Soils + Pan:	Plastic limit cannot be determined					
Weight of Dry Soils + Pan:						
Weight of Pan:						
Weight of Dry Soils:						
Weight of Moisture:						
% Moisture:						



Copyright Spears Engineering & Technical Services PS, 1996-98  
 All results apply only to actual locations and materials tested. As a mutual protection to clients, the public and ourselves, all reports are submitted as the confidential property of clients, and authorization for publication of statements, conclusions or extracts from or regarding our reports is reserved pending our written approval.

**Comments:** Liquid limit cannot be established as the material displays rapid dilation upon spreading into the cup. At lower moistures the material does not spread into the liquid limit device without tearing the soil cake. Plastic limit cannot be determined as the material does not roll down to 1/8" threads before cracking or crumbling. Non-plastic.

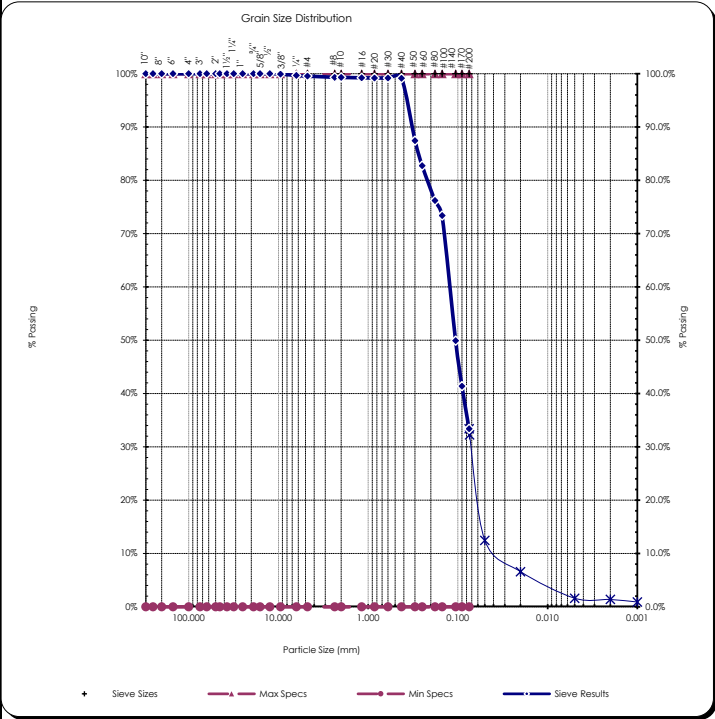
Reviewed by:   
 Meghan Blodgett-Carrillo

# Sieve Report

<b>Project:</b> Q.C. - Lower Duwamish Waterway <b>Project #:</b> 21B233 <b>Client:</b> Anchor QEA <b>Source:</b> LDW21-GT1-GB-10-20 ft <b>Sample#:</b> B21-1551	<b>Date Received:</b> 29-Jul-21 <b>Sampled By:</b> Client <b>Date Tested:</b> 1-Sep-21 <b>Tested By:</b> C. Kriss	<b>Unified Soil Classification System, ASTM-2487</b> SM, Silty Sand <b>Sample Color:</b> brown	 <b>ACCREDITED</b> Certificate #: 1366.01
---	--	---	---

<b>ASTM D2216, ASTM D2419, ASTM D4318, ASTM D5281</b>			
<b>Specifications</b> No Specs <b>Sample Meets Specs ?</b> N/A	D <sub>(5)</sub> = 0.013 mm D <sub>(10)</sub> = 0.037 mm D <sub>(15)</sub> = 0.059 mm D <sub>(30)</sub> = 0.072 mm D <sub>(50)</sub> = 0.106 mm D <sub>(60)</sub> = 0.125 mm D <sub>(90)</sub> = 0.327 mm Dust Ratio = 33/98	% Gravel = 0.5% % Sand = 66.2% % Silt & Clay = 33.4% Liquid Limit = n/a Plasticity Index = n/a Sand Equivalent = n/a Fracture %, 1 Face = n/a Fracture %, 2+ Faces = n/a	Coeff. of Curvature, C <sub>c</sub> = 1.11 Coeff. of Uniformity, C <sub>u</sub> = 3.34 Fineness Modulus = 0.42 Plastic Limit = n/a Moisture %, as sampled = 57.6% Req'd Sand Equivalent = Req'd Fracture %, 1 Face = Req'd Fracture %, 2+ Faces =

<b>ASTM C136, ASTM D6913, ASTM C117</b>					
Sieve Size		Actual Cumulative Percent Passing	Interpolated Cumulative Percent Passing	Specs Max	Specs Min
US	Metric				
12.00"	300.00		100%	100.0%	0.0%
10.00"	250.00		100%	100.0%	0.0%
8.00"	200.00		100%	100.0%	0.0%
6.00"	150.00		100%	100.0%	0.0%
4.00"	100.00		100%	100.0%	0.0%
3.00"	75.00		100%	100.0%	0.0%
2.50"	63.00		100%	100.0%	0.0%
2.00"	50.00	100%	100%	100.0%	0.0%
1.75"	45.00	100%	100%	100.0%	0.0%
1.50"	37.50	100%	100%	100.0%	0.0%
1.25"	31.50	100%	100%	100.0%	0.0%
1.00"	25.00	100%	100%	100.0%	0.0%
3/4"	19.00	100%	100%	100.0%	0.0%
5/8"	16.00	100%	100%	100.0%	0.0%
1/2"	12.50	100%	100%	100.0%	0.0%
3/8"	9.50	100%	100%	100.0%	0.0%
1/4"	6.30	100%	100%	100.0%	0.0%
#4	4.75	100%	100%	100.0%	0.0%
#8	2.36	99%	99%	100.0%	0.0%
#10	2.00	99%	99%	100.0%	0.0%
#16	1.18	99%	99%	100.0%	0.0%
#20	0.850	99%	99%	100.0%	0.0%
#30	0.600	99%	99%	100.0%	0.0%
#40	0.425	99%	99%	100.0%	0.0%
#50	0.300	87%	87%	100.0%	0.0%
#60	0.250	83%	83%	100.0%	0.0%
#80	0.180	76%	76%	100.0%	0.0%
#100	0.150	73%	73%	100.0%	0.0%
#140	0.106	50%	50%	100.0%	0.0%
#170	0.090	41%	41%	100.0%	0.0%
#200	0.075	33.4%	33.4%	100.0%	0.0%



Copyright Spears Engineering & Technical Services PS, 1996-98

All results apply only to actual locations and materials tested. As a mutual protection to clients, the public and ourselves, all reports are submitted as the confidential property of clients, and authorization for publication of statements, conclusions or extracts from or regarding our reports is reserved pending our written approval.

**Comments:** \_\_\_\_\_

Reviewed by:   
 Meghan Blodgett-Carrillo

## Hydrometer Report

<b>Project:</b> Q.C. - Lower Duwamish Waterway <b>Date Received:</b> 29-Jul-21 <b>Project #:</b> 21B233 <b>Sampled By:</b> Client <b>Client:</b> Anchor QEA <b>Date Tested:</b> 1-Sep-21 <b>Source:</b> LDW21-GT1-GB-10-20 ft <b>Tested By:</b> C. Kriss <b>Sample#:</b> B21-1551	<b>Unified Soil Classification System, ASTM-2487</b> SM, Silty Sand <b>Sample Color</b> brown																																																																																																																																											
<b>ASTM D7928, HYDROMETER ANALYSIS</b>	<b>ASTM D6913</b>																																																																																																																																											
<table style="width: 100%;"> <tr> <td><b>Sp Gr :</b></td> <td style="background-color: yellow;">2.53</td> <td></td> </tr> <tr> <td><b>Sample Weight:</b></td> <td style="background-color: yellow;">75.48</td> <td>grams</td> </tr> <tr> <td><b>Hydroscopic Moist.:</b></td> <td style="background-color: yellow;">2.34%</td> <td></td> </tr> <tr> <td><b>Adj. Sample Wgt :</b></td> <td style="background-color: yellow;">73.75</td> <td>grams</td> </tr> </table> <table style="width: 100%;"> <thead> <tr> <th style="text-align: left;">Hydrometer Reading</th> <th style="text-align: left;">Corrected Reading</th> <th style="text-align: left;">Percent Passing</th> <th style="text-align: left;">Soils Particle Diameter</th> </tr> </thead> <tbody> <tr><td>1</td><td style="background-color: yellow;">8</td><td>11.1%</td><td>0.0554 mm</td></tr> <tr><td>2</td><td style="background-color: yellow;">7.5</td><td>10.4%</td><td>0.0394 mm</td></tr> <tr><td>5</td><td style="background-color: yellow;">5.5</td><td>7.6%</td><td>0.0252 mm</td></tr> <tr><td>15</td><td style="background-color: yellow;">4</td><td>5.5%</td><td>0.0146 mm</td></tr> <tr><td>30</td><td style="background-color: yellow;">3</td><td>4.2%</td><td>0.0104 mm</td></tr> <tr><td>60</td><td style="background-color: yellow;">1.5</td><td>2.1%</td><td>0.0074 mm</td></tr> <tr><td>240</td><td style="background-color: yellow;">1</td><td>1.4%</td><td>0.0037 mm</td></tr> <tr><td>1440</td><td style="background-color: yellow;">1</td><td>1.4%</td><td>0.0015 mm</td></tr> </tbody> </table> <table style="width: 100%;"> <tr> <td><b>% Gravel:</b></td> <td>0.5%</td> <td><b>Liquid Limit:</b></td> <td>n/a</td> </tr> <tr> <td><b>% Sand:</b></td> <td>66.2%</td> <td><b>Plastic Limit:</b></td> <td>n/a</td> </tr> <tr> <td><b>% Silt:</b></td> <td>31.8%</td> <td><b>Plasticity Index:</b></td> <td>n/a</td> </tr> <tr> <td><b>% Clay:</b></td> <td>1.6%</td> <td></td> <td></td> </tr> </table>	<b>Sp Gr :</b>	2.53		<b>Sample Weight:</b>	75.48	grams	<b>Hydroscopic Moist.:</b>	2.34%		<b>Adj. Sample Wgt :</b>	73.75	grams	Hydrometer Reading	Corrected Reading	Percent Passing	Soils Particle Diameter	1	8	11.1%	0.0554 mm	2	7.5	10.4%	0.0394 mm	5	5.5	7.6%	0.0252 mm	15	4	5.5%	0.0146 mm	30	3	4.2%	0.0104 mm	60	1.5	2.1%	0.0074 mm	240	1	1.4%	0.0037 mm	1440	1	1.4%	0.0015 mm	<b>% Gravel:</b>	0.5%	<b>Liquid Limit:</b>	n/a	<b>% Sand:</b>	66.2%	<b>Plastic Limit:</b>	n/a	<b>% Silt:</b>	31.8%	<b>Plasticity Index:</b>	n/a	<b>% Clay:</b>	1.6%			<table style="width: 100%;"> <tr> <th colspan="3" style="text-align: center;">Sieve Analysis</th> </tr> <tr> <th colspan="3" style="text-align: center;">Grain Size Distribution</th> </tr> <tr> <th style="text-align: left;">Sieve Size</th> <th style="text-align: left;">Percent Passing</th> <th style="text-align: left;">Soils Particle Diameter</th> </tr> <tr><td>3.0"</td><td>100%</td><td>75.000 mm</td></tr> <tr><td>2.0"</td><td>100%</td><td>50.000 mm</td></tr> <tr><td>1.5"</td><td>100%</td><td>37.500 mm</td></tr> <tr><td>1.25"</td><td>100%</td><td>31.500 mm</td></tr> <tr><td>1.0"</td><td>100%</td><td>25.000 mm</td></tr> <tr><td>3/4"</td><td>100%</td><td>19.000 mm</td></tr> <tr><td>5/8"</td><td>100%</td><td>16.000 mm</td></tr> <tr><td>1/2"</td><td>100%</td><td>12.500 mm</td></tr> <tr><td>3/8"</td><td>100%</td><td>9.500 mm</td></tr> <tr><td>1/4"</td><td>100%</td><td>6.300 mm</td></tr> <tr><td>#4</td><td>100%</td><td>4.750 mm</td></tr> <tr><td>#10</td><td>99%</td><td>2.000 mm</td></tr> <tr><td>#20</td><td>99%</td><td>0.850 mm</td></tr> <tr><td>#40</td><td>99%</td><td>0.425 mm</td></tr> <tr><td>#100</td><td>73%</td><td>0.150 mm</td></tr> <tr><td>#200</td><td>33.4%</td><td>0.075 mm</td></tr> <tr><td style="text-align: center;"><b>Silts</b></td><td>32.2%</td><td>0.074 mm</td></tr> <tr><td></td><td>12.5%</td><td>0.050 mm</td></tr> <tr><td></td><td>6.6%</td><td>0.020 mm</td></tr> <tr><td style="text-align: center;"><b>Clays</b></td><td>1.6%</td><td>0.005 mm</td></tr> <tr><td></td><td>1.4%</td><td>0.002 mm</td></tr> <tr><td style="text-align: center;"><b>Colloids</b></td><td>0.9%</td><td>0.001 mm</td></tr> </table>	Sieve Analysis			Grain Size Distribution			Sieve Size	Percent Passing	Soils Particle Diameter	3.0"	100%	75.000 mm	2.0"	100%	50.000 mm	1.5"	100%	37.500 mm	1.25"	100%	31.500 mm	1.0"	100%	25.000 mm	3/4"	100%	19.000 mm	5/8"	100%	16.000 mm	1/2"	100%	12.500 mm	3/8"	100%	9.500 mm	1/4"	100%	6.300 mm	#4	100%	4.750 mm	#10	99%	2.000 mm	#20	99%	0.850 mm	#40	99%	0.425 mm	#100	73%	0.150 mm	#200	33.4%	0.075 mm	<b>Silts</b>	32.2%	0.074 mm		12.5%	0.050 mm		6.6%	0.020 mm	<b>Clays</b>	1.6%	0.005 mm		1.4%	0.002 mm	<b>Colloids</b>	0.9%	0.001 mm
<b>Sp Gr :</b>	2.53																																																																																																																																											
<b>Sample Weight:</b>	75.48	grams																																																																																																																																										
<b>Hydroscopic Moist.:</b>	2.34%																																																																																																																																											
<b>Adj. Sample Wgt :</b>	73.75	grams																																																																																																																																										
Hydrometer Reading	Corrected Reading	Percent Passing	Soils Particle Diameter																																																																																																																																									
1	8	11.1%	0.0554 mm																																																																																																																																									
2	7.5	10.4%	0.0394 mm																																																																																																																																									
5	5.5	7.6%	0.0252 mm																																																																																																																																									
15	4	5.5%	0.0146 mm																																																																																																																																									
30	3	4.2%	0.0104 mm																																																																																																																																									
60	1.5	2.1%	0.0074 mm																																																																																																																																									
240	1	1.4%	0.0037 mm																																																																																																																																									
1440	1	1.4%	0.0015 mm																																																																																																																																									
<b>% Gravel:</b>	0.5%	<b>Liquid Limit:</b>	n/a																																																																																																																																									
<b>% Sand:</b>	66.2%	<b>Plastic Limit:</b>	n/a																																																																																																																																									
<b>% Silt:</b>	31.8%	<b>Plasticity Index:</b>	n/a																																																																																																																																									
<b>% Clay:</b>	1.6%																																																																																																																																											
Sieve Analysis																																																																																																																																												
Grain Size Distribution																																																																																																																																												
Sieve Size	Percent Passing	Soils Particle Diameter																																																																																																																																										
3.0"	100%	75.000 mm																																																																																																																																										
2.0"	100%	50.000 mm																																																																																																																																										
1.5"	100%	37.500 mm																																																																																																																																										
1.25"	100%	31.500 mm																																																																																																																																										
1.0"	100%	25.000 mm																																																																																																																																										
3/4"	100%	19.000 mm																																																																																																																																										
5/8"	100%	16.000 mm																																																																																																																																										
1/2"	100%	12.500 mm																																																																																																																																										
3/8"	100%	9.500 mm																																																																																																																																										
1/4"	100%	6.300 mm																																																																																																																																										
#4	100%	4.750 mm																																																																																																																																										
#10	99%	2.000 mm																																																																																																																																										
#20	99%	0.850 mm																																																																																																																																										
#40	99%	0.425 mm																																																																																																																																										
#100	73%	0.150 mm																																																																																																																																										
#200	33.4%	0.075 mm																																																																																																																																										
<b>Silts</b>	32.2%	0.074 mm																																																																																																																																										
	12.5%	0.050 mm																																																																																																																																										
	6.6%	0.020 mm																																																																																																																																										
<b>Clays</b>	1.6%	0.005 mm																																																																																																																																										
	1.4%	0.002 mm																																																																																																																																										
<b>Colloids</b>	0.9%	0.001 mm																																																																																																																																										
<b>USDA Soil Textural Classification</b>																																																																																																																																												
<table style="width: 100%;"> <tr> <td></td> <td style="text-align: center;"><b>Particle Size</b></td> </tr> <tr> <td><b>% Sand:</b></td> <td style="text-align: center;">2.0 - 0.05 mm</td> </tr> <tr> <td><b>% Silt:</b></td> <td style="text-align: center;">0.05 - 0.002 mm</td> </tr> <tr> <td><b>% Clay:</b></td> <td style="text-align: center;">&lt; 0.002 mm</td> </tr> </table> <p style="text-align: center;"><b>USDA Soil Textural Classification</b> Sand</p>		<b>Particle Size</b>	<b>% Sand:</b>	2.0 - 0.05 mm	<b>% Silt:</b>	0.05 - 0.002 mm	<b>% Clay:</b>	< 0.002 mm																																																																																																																																				
	<b>Particle Size</b>																																																																																																																																											
<b>% Sand:</b>	2.0 - 0.05 mm																																																																																																																																											
<b>% Silt:</b>	0.05 - 0.002 mm																																																																																																																																											
<b>% Clay:</b>	< 0.002 mm																																																																																																																																											

All results apply only to actual locations and materials tested. As a mutual protection to clients, the public and ourselves, all reports are submitted as the confidential property of clients, and authorization for publication of statements, conclusions or extracts from or regarding our reports is reserved pending our written approval.

**Comments:** \_\_\_\_\_

\_\_\_\_\_

\_\_\_\_\_

**Reviewed by:** \_\_\_\_\_  
 Meghan Blodgett-Carrillo

# Direct Shear Test Results:

ASTM D-3080



Project: Q.C. - Lower Duwamish Waterway  
 Project Number: 21B233  
 Laboratory Sample ID: B21-1551  
 Sample Date: 7/9/2021  
 Test Date: 9/23/2021  
 Technician: M. Carrillo

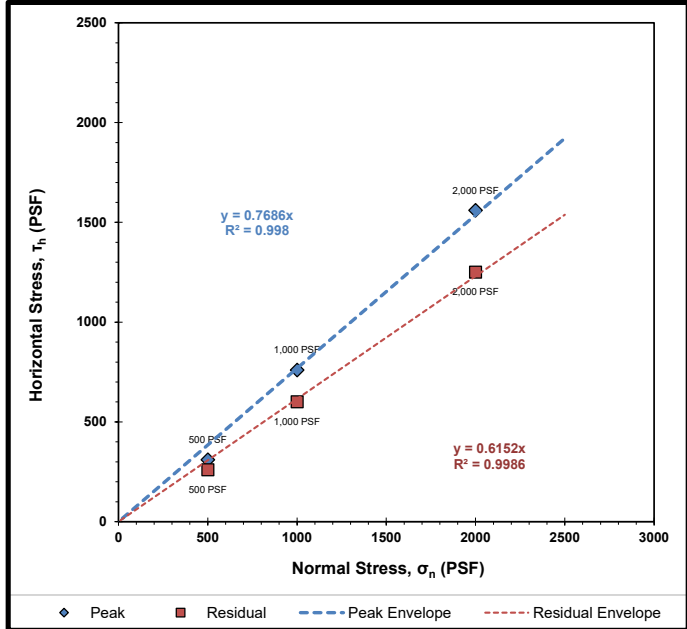
Sample Source: LDW21-GT1-GB-10-20 ft  
 Visual Soil Description: brown silty sand  
 Type of Specimen: Remolded Cylindrical Shear Box  
 Specimen Diameter (in): 2.5  
 Specimen Height (in): 1  
 Rate of Strain (in/min): 0.0208  
 Estimated Specific Gravity of Solids: 2.65

Summary of Sample Data: $\sigma_n=500$ PSF		
Initial Moisture Content (%)	30.0	
	Initial	Post-Consolidation
Dry Density (PCF):	106.5	108.9
Void Ratio:	0.581	0.547
Porosity (%):	36.8	35.4
Degree of Saturation (%):	saturated	saturated

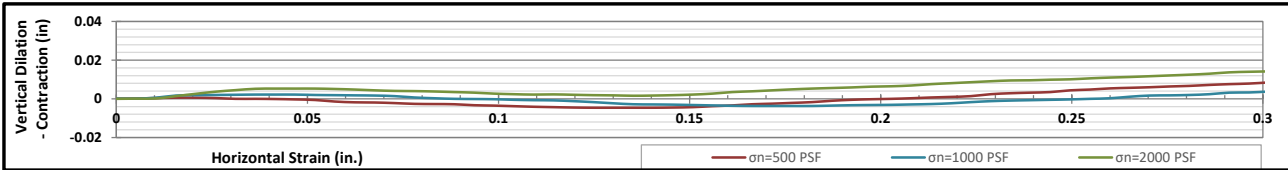
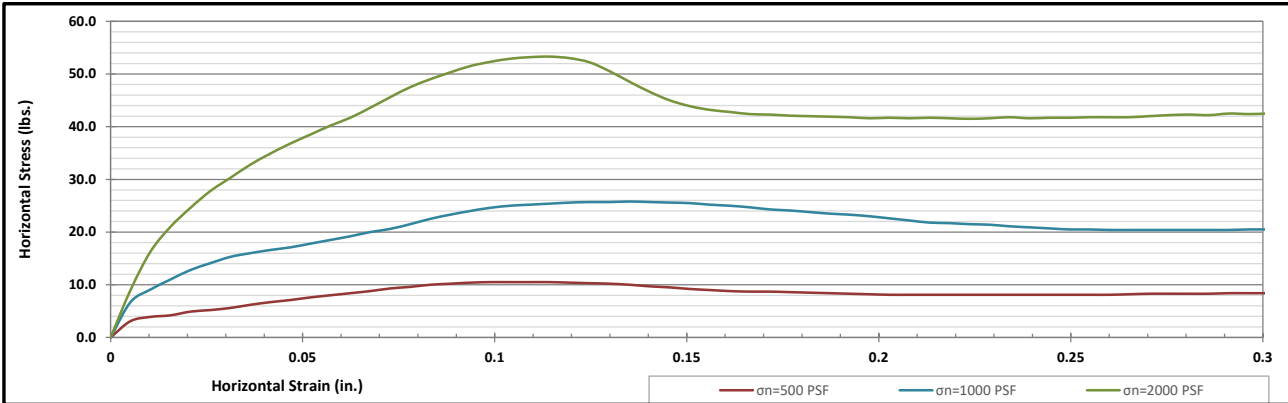
Summary of Sample Data: $\sigma_n=1000$ PSF		
Initial Moisture Content (%)	29.7	
	Initial	Post-Consolidation
Dry Density (PCF):	598.3	612.5
Void Ratio:	-0.718	-0.725
Porosity (%):	-255.1	-263.6
Degree of Saturation (%):	-111.5	saturated

Summary of Sample Data: $\sigma_n=2000$ PSF		
Initial Moisture Content (%)	29.8	
	Initial	Post-Consolidation
Dry Density (PCF):	107.6	113.2
Void Ratio:	0.566	0.488
Porosity (%):	36.1	32.8
Degree of Saturation (%):	saturated	saturated

ESTIMATED STRENGTH PARAMETERS		
	PEAK	RESIDUAL
Angle of Internal Friction, $\phi$ (°):	38	32
Cohesion (PSF):	0	0



Failure Envelope Test Values:			
Normal Stress, $\sigma_n$ (PSF):	500	1000	2000
Peak Horizontal Stress, $\tau_h$ (PSF):	310	760	1560
Residual Horizontal Stress, $\tau_r$ (PSF):	260	600	1250



Corporate • 777 Chrysler Drive • Burlington, WA 98233 • Phone 360.755.1990 • Fax 360.755.1980  
 SW Region • 2118 Black Lake Blvd. S.W. • Olympia, WA 98512 • Phone 360.534.9777 • Fax 360.534.9779  
 NW Region • 805 Dupont, Suite #5 • Bellingham, WA 98225 • Phone 360.647.6061 • Fax 360.647.8111  
 Kitsap Region • 5451 N.W. Newberry Hill Road, Suite 101 • Silverdale, WA 98383 • Phone/Fax 360.698.6787

Visit our website: [www.mtc-inc.net](http://www.mtc-inc.net)



**Client:** Anchor QEA  
**Address:** 21328 2nd Drive SE  
Bothell, WA 98021  
**Attn:** Garrett Timm  
**Revised on:** \_\_\_\_\_

**Date:** October 1, 2021  
**Project:** Q.C. - Lower Duwamish Waterway  
**Project #:** 21B233  
**Sample #:** B21-1563-1577  
**Date sampled:** 7-12-21 & 7-13-21

As requested MTC, Inc. has performed the following test(s) on the sample referenced above. The testing was performed in accordance with current applicable AASHTO or ASTM standards as indicated below. The results obtained in our laboratory were as follows below or on the attached pages:

	Test(s) Performed:	Test Results		Test(s) Performed:	Test Results
X	Sieve Analysis	Please See Attached Reports		Sulfate Soundness	
	Proctor			Bulk Density & Voids	
	Sand Equivalent			WSDOT Degradation	
	Fracture Count			LA Abrasion	
X	Moisture Content	Please See Attached Report	X	Direct Shear	Please See Attached Reports
	Specific Gravity, Coarse		X	Specific Gravity, Soils	Please See Attached Reports
	Specific Gravity, Fine				
X	Hydrometer Analysis	Please See Attached Reports			
X	Atterberg Limits	Please See Attached Reports			

If you have any questions concerning the test results, the procedures used, or if we can be of any further assistance please call on us at the number below.

Respectfully Submitted,  
 Meghan Blodgett-Carrillo  
 WABO Supervising Laboratory Technician



## Moisture Content - ASTM C566, ASTM D2216

**Project:** Q.C. - Lower Duwamish Waterway  
**Project #:** 21B233  
**Date Received:** July 29, 2021  
**Date Tested:** September 3, 2021

**Client:** Anchor QEA  
**Sampled by:** Client  
**Tested by:** A. Eifrig

Sample #	Location	Tare	Wet + Tare	Dry + Tare	Wgt. Of Moisture	Wgt. Of Soil	% Moisture
B21-1563	LDW21-GT13-GB-0-1.5 ft	229.0	1015.9	773.9	242.0	544.9	44.4%
B21-1564	LDW21-GT13-GB-0-11 ft	221.0	537.3	449.8	87.5	228.8	38.2%
B21-1565	LDW21-GT13-GB-11-12.5 ft	217.1	1140.1	930.2	209.9	713.1	29.4%
B21-1566	LDW21-GT13-GB-11-21 ft	233.4	922.3	739.9	182.4	506.5	36.0%
B21-1567	LDW21-GT13-GB-21-22.5 ft	222.0	1231.9	1002.3	229.6	780.3	29.4%
B21-1568	LDW21-GT13-GB-21-31 ft	222.1	758.0	621.0	137.0	398.9	34.3%
B21-1569	LDW21-GT13-GB-31-32.5 ft	208.7	1100.3	893.6	206.7	684.9	30.2%
B21-1570	LDW21-GT19-GB-0-1.5 ft	234.8	863.2	678.6	184.6	443.8	41.6%
B21-1571	LDW21-GT19-GB-0-6.9 ft	222.1	761.3	524.7	236.6	302.6	78.2%
B21-1572	LDW21-GT19-GB-6.9-8.5 ft	233.1	1713.9	1391.1	322.8	1158.0	27.9%
B21-1573	LDW21-GT19-GB-8.5-10 ft	220.2	954.0	779.7	174.3	559.5	31.2%
B21-1574	LDW21-GT19-GB-8.5-18.5 ft	224.3	805.4	688.5	116.9	464.2	25.2%
B21-1575	LDW21-GT19-GB-18.5-20 ft	229.6	1121.9	927.8	194.1	698.2	27.8%
B21-1576	LDW21-GT19-GB-18.5-28.5 ft	215.7	1329.2	1088.0	241.2	872.3	27.7%
B21-1577	LDW21-GT19-GB-28.5-30 ft	225.2	725.0	616.3	108.7	391.1	27.8%

All results apply only to actual locations and materials tested. As a mutual protection to clients, the public and ourselves, all reports are submitted as the confidential property of clients, and authorization for publication of statements, conclusions or extracts from or regarding our reports is reserved pending our written approval.

Reviewed by:   
 Meghan Blodgett-Carrillo





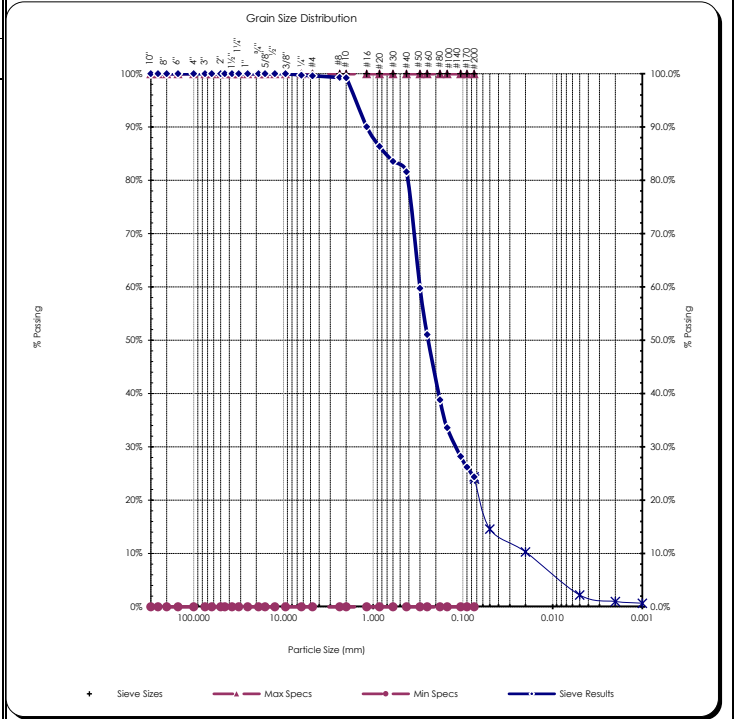
# Sieve Report

<b>Project:</b> Q.C. - Lower Duwamish Waterway <b>Project #:</b> 21B233 <b>Client:</b> Anchor QEA <b>Source:</b> LDW21-GT13-GB-0-11 ft <b>Sample#:</b> B21-1564	<b>Date Received:</b> 29-Jul-21 <b>Sampled By:</b> Client <b>Date Tested:</b> 1-Sep-21 <b>Tested By:</b> C. Kriss	<b>Unified Soil Classification System, ASTM-2487</b> SM, Silty Sand <b>Sample Color:</b> brown	 Certificate #: 1366.01
---	--	---	----------------------------

<b>ASTM D2216, ASTM D2419, ASTM D4318, ASTM D5281</b>			
<b>Specifications</b> No Specs <b>Sample Meets Specs ? N/A</b>	D <sub>(5)</sub> = 0.008 mm D <sub>(10)</sub> = 0.019 mm D <sub>(15)</sub> = 0.053 mm D <sub>(30)</sub> = 0.121 mm D <sub>(50)</sub> = 0.244 mm D <sub>(60)</sub> = 0.301 mm D <sub>(90)</sub> = 1.175 mm Dust Ratio = 26/87	% Gravel = 0.4% % Sand = 75.2% % Silt & Clay = 24.4% Liquid Limit = 0.0% Plasticity Index = 0.0% Sand Equivalent = n/a Fracture %, 1 Face = n/a Fracture %, 2+ Faces = n/a	Coeff. of Curvature, C <sub>c</sub> = 2.52 Coeff. of Uniformity, C <sub>u</sub> = 15.71 Fineness Modulus = 1.34 Plastic Limit = 0.0% Moisture %, as sampled = 38.2% Req'd Sand Equivalent = Req'd Fracture %, 1 Face = Req'd Fracture %, 2+ Faces =

**ASTM C136, ASTM D6913, ASTM C117**

Sieve Size		Actual Cumulative Percent Passing	Interpolated Cumulative Percent Passing	Specs Max	Specs Min
US	Metric				
12.00"	300.00		100%	100.0%	0.0%
10.00"	250.00		100%	100.0%	0.0%
8.00"	200.00		100%	100.0%	0.0%
6.00"	150.00		100%	100.0%	0.0%
4.00"	100.00		100%	100.0%	0.0%
3.00"	75.00		100%	100.0%	0.0%
2.50"	63.00		100%	100.0%	0.0%
2.00"	50.00	100%	100%	100.0%	0.0%
1.75"	45.00		100%	100.0%	0.0%
1.50"	37.50		100%	100.0%	0.0%
1.25"	31.50		100%	100.0%	0.0%
1.00"	25.00	100%	100%	100.0%	0.0%
3/4"	19.00	100%	100%	100.0%	0.0%
5/8"	16.00		100%	100.0%	0.0%
1/2"	12.50	100%	100%	100.0%	0.0%
3/8"	9.50	100%	100%	100.0%	0.0%
1/4"	6.30		100%	100.0%	0.0%
#4	4.75	100%	100%	100.0%	0.0%
#8	2.36		99%	100.0%	0.0%
#10	2.00	99%	99%	100.0%	0.0%
#16	1.18		90%	100.0%	0.0%
#20	0.850		86%	100.0%	0.0%
#30	0.600		84%	100.0%	0.0%
#40	0.425	82%	82%	100.0%	0.0%
#50	0.300		60%	100.0%	0.0%
#60	0.250		51%	100.0%	0.0%
#80	0.180		39%	100.0%	0.0%
#100	0.150	34%	34%	100.0%	0.0%
#140	0.106		28%	100.0%	0.0%
#170	0.090		26%	100.0%	0.0%
#200	0.075	24.4%	24.4%	100.0%	0.0%



Copyright Spears Engineering & Technical Services PS, 1996-98  
 All results apply only to actual locations and materials tested. As a mutual protection to clients, the public and ourselves, all reports are submitted as the confidential property of clients, and authorization for publication of statements, conclusions or extracts from or regarding our reports is reserved pending our written approval.

**Comments:** \_\_\_\_\_

Reviewed by:   
 Meghan Blodgett-Carrillo

## Hydrometer Report

<p><b>Project:</b> Q.C. - Lower Duwamish Waterway    <b>Date Received:</b> 29-Jul-21  <b>Project #:</b> 21B233    <b>Sampled By:</b> Client  <b>Client:</b> Anchor QEA    <b>Date Tested:</b> 1-Sep-21  <b>Source:</b> LDW21-GT13-GB-0-11 ft    <b>Tested By:</b> C. Kriss  <b>Sample#:</b> B21-1564</p>	<p><b>Unified Soil Classification System, ASTM-2487</b>  SM, Silty Sand  <b>Sample Color</b>  brown</p>																																																																																																									
<b>ASTM D7928, HYDROMETER ANALYSIS</b>	<b>ASTM D6913</b>																																																																																																									
<p>Sp Gr : 2.61  Sample Weight: 100.15 grams  Hydroscopic Moist.: 0.83%  Adj. Sample Wgt : 99.33 grams</p> <div style="text-align: center;">   <b>ACCREDITED</b>  Certificate #: 1366.01 </div> <table style="width: 100%; border-collapse: collapse; margin-top: 10px;"> <thead> <tr> <th style="text-align: left;">Hydrometer Reading</th> <th style="text-align: left;">Corrected Reading</th> <th style="text-align: left;">Percent Passing</th> <th style="text-align: left;">Soils Particle Diameter</th> </tr> </thead> <tbody> <tr><td>1</td><td>14.5</td><td>14.6%</td><td>0.0519 mm</td></tr> <tr><td>2</td><td>13</td><td>13.1%</td><td>0.0369 mm</td></tr> <tr><td>5</td><td>11.5</td><td>11.6%</td><td>0.0236 mm</td></tr> <tr><td>15</td><td>8</td><td>8.1%</td><td>0.0139 mm</td></tr> <tr><td>30</td><td>6.5</td><td>6.6%</td><td>0.0099 mm</td></tr> <tr><td>60</td><td>4</td><td>4.0%</td><td>0.0071 mm</td></tr> <tr><td>240</td><td>1</td><td>1.0%</td><td>0.0036 mm</td></tr> <tr><td>1440</td><td>1</td><td>1.0%</td><td>0.0015 mm</td></tr> </tbody> </table> <p style="margin-top: 10px;"> <b>% Gravel:</b> 0.4%                                    <b>Liquid Limit:</b> 0.0 %  <b>% Sand:</b> 75.2%                                   <b>Plastic Limit:</b> 0.0 %  <b>% Silt:</b> 22.2%                                   <b>Plasticity Index:</b> 0.0 %  <b>% Clay:</b> 2.2% </p>	Hydrometer Reading	Corrected Reading	Percent Passing	Soils Particle Diameter	1	14.5	14.6%	0.0519 mm	2	13	13.1%	0.0369 mm	5	11.5	11.6%	0.0236 mm	15	8	8.1%	0.0139 mm	30	6.5	6.6%	0.0099 mm	60	4	4.0%	0.0071 mm	240	1	1.0%	0.0036 mm	1440	1	1.0%	0.0015 mm	<p style="text-align: center;">Sieve Analysis Grain Size Distribution</p> <table style="width: 100%; border-collapse: collapse;"> <thead> <tr> <th style="text-align: left;">Sieve Size</th> <th style="text-align: left;">Percent Passing</th> <th style="text-align: left;">Soils Particle Diameter</th> </tr> </thead> <tbody> <tr><td>3.0"</td><td>100%</td><td>75.000 mm</td></tr> <tr><td>2.0"</td><td>100%</td><td>50.000 mm</td></tr> <tr><td>1.5"</td><td>100%</td><td>37.500 mm</td></tr> <tr><td>1.25"</td><td>100%</td><td>31.500 mm</td></tr> <tr><td>1.0"</td><td>100%</td><td>25.000 mm</td></tr> <tr><td>3/4"</td><td>100%</td><td>19.000 mm</td></tr> <tr><td>5/8"</td><td>100%</td><td>16.000 mm</td></tr> <tr><td>1/2"</td><td>100%</td><td>12.500 mm</td></tr> <tr><td>3/8"</td><td>100%</td><td>9.500 mm</td></tr> <tr><td>1/4"</td><td>100%</td><td>6.300 mm</td></tr> <tr><td>#4</td><td>100%</td><td>4.750 mm</td></tr> <tr><td>#10</td><td>99%</td><td>2.000 mm</td></tr> <tr><td>#20</td><td>86%</td><td>0.850 mm</td></tr> <tr><td>#40</td><td>82%</td><td>0.425 mm</td></tr> <tr><td>#100</td><td>34%</td><td>0.150 mm</td></tr> <tr><td>#200</td><td>24.4%</td><td>0.075 mm</td></tr> <tr><td><b>Silts</b></td><td>24.0%</td><td>0.074 mm</td></tr> <tr><td></td><td>14.6%</td><td>0.050 mm</td></tr> <tr><td></td><td>10.3%</td><td>0.020 mm</td></tr> <tr><td><b>Clays</b></td><td>2.2%</td><td>0.005 mm</td></tr> <tr><td></td><td>1.0%</td><td>0.002 mm</td></tr> <tr><td><b>Colloids</b></td><td>0.7%</td><td>0.001 mm</td></tr> </tbody> </table>	Sieve Size	Percent Passing	Soils Particle Diameter	3.0"	100%	75.000 mm	2.0"	100%	50.000 mm	1.5"	100%	37.500 mm	1.25"	100%	31.500 mm	1.0"	100%	25.000 mm	3/4"	100%	19.000 mm	5/8"	100%	16.000 mm	1/2"	100%	12.500 mm	3/8"	100%	9.500 mm	1/4"	100%	6.300 mm	#4	100%	4.750 mm	#10	99%	2.000 mm	#20	86%	0.850 mm	#40	82%	0.425 mm	#100	34%	0.150 mm	#200	24.4%	0.075 mm	<b>Silts</b>	24.0%	0.074 mm		14.6%	0.050 mm		10.3%	0.020 mm	<b>Clays</b>	2.2%	0.005 mm		1.0%	0.002 mm	<b>Colloids</b>	0.7%	0.001 mm
Hydrometer Reading	Corrected Reading	Percent Passing	Soils Particle Diameter																																																																																																							
1	14.5	14.6%	0.0519 mm																																																																																																							
2	13	13.1%	0.0369 mm																																																																																																							
5	11.5	11.6%	0.0236 mm																																																																																																							
15	8	8.1%	0.0139 mm																																																																																																							
30	6.5	6.6%	0.0099 mm																																																																																																							
60	4	4.0%	0.0071 mm																																																																																																							
240	1	1.0%	0.0036 mm																																																																																																							
1440	1	1.0%	0.0015 mm																																																																																																							
Sieve Size	Percent Passing	Soils Particle Diameter																																																																																																								
3.0"	100%	75.000 mm																																																																																																								
2.0"	100%	50.000 mm																																																																																																								
1.5"	100%	37.500 mm																																																																																																								
1.25"	100%	31.500 mm																																																																																																								
1.0"	100%	25.000 mm																																																																																																								
3/4"	100%	19.000 mm																																																																																																								
5/8"	100%	16.000 mm																																																																																																								
1/2"	100%	12.500 mm																																																																																																								
3/8"	100%	9.500 mm																																																																																																								
1/4"	100%	6.300 mm																																																																																																								
#4	100%	4.750 mm																																																																																																								
#10	99%	2.000 mm																																																																																																								
#20	86%	0.850 mm																																																																																																								
#40	82%	0.425 mm																																																																																																								
#100	34%	0.150 mm																																																																																																								
#200	24.4%	0.075 mm																																																																																																								
<b>Silts</b>	24.0%	0.074 mm																																																																																																								
	14.6%	0.050 mm																																																																																																								
	10.3%	0.020 mm																																																																																																								
<b>Clays</b>	2.2%	0.005 mm																																																																																																								
	1.0%	0.002 mm																																																																																																								
<b>Colloids</b>	0.7%	0.001 mm																																																																																																								
<b>USDA Soil Textural Classification</b>																																																																																																										
<table style="width: 100%; border-collapse: collapse;"> <tr> <td style="width: 30%;"><b>% Sand:</b></td> <td>2.0 - 0.05 mm</td> </tr> <tr> <td><b>% Silt:</b></td> <td>0.05 - 0.002 mm</td> </tr> <tr> <td><b>% Clay:</b></td> <td>&lt; 0.002 mm</td> </tr> </table> <p style="text-align: center; margin-top: 10px;"> <b>USDA Soil Textural Classification</b>  Loamy Sand </p>	<b>% Sand:</b>	2.0 - 0.05 mm	<b>% Silt:</b>	0.05 - 0.002 mm	<b>% Clay:</b>	< 0.002 mm																																																																																																				
<b>% Sand:</b>	2.0 - 0.05 mm																																																																																																									
<b>% Silt:</b>	0.05 - 0.002 mm																																																																																																									
<b>% Clay:</b>	< 0.002 mm																																																																																																									

All results apply only to actual locations and materials tested. As a mutual protection to clients, the public and ourselves, all reports are submitted as the confidential property of clients, and authorization for publication of statements, conclusions or extracts from or regarding our reports is reserved pending our written approval.

**Comments:** \_\_\_\_\_  
\_\_\_\_\_  
\_\_\_\_\_

**Reviewed by:**   
\_\_\_\_\_   
Meghan Blodgett-Carrillo

# Direct Shear Test Results:

ASTM D-3080



Project: Q.C. - Lower Duwamish Waterway  
 Project Number: 21B233  
 Laboratory Sample ID: B21-1564  
 Sample Date: 7/12/2021  
 Test Date: 9/20/2021  
 Technician: M. Carrillo

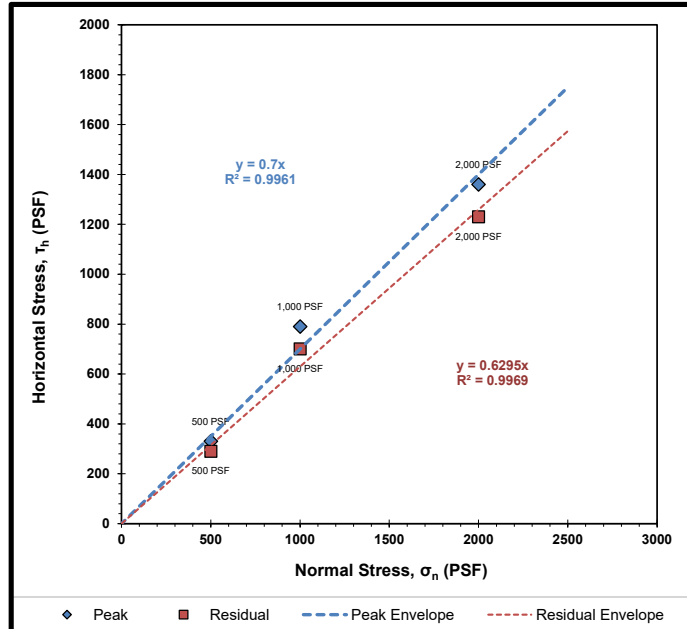
Sample Source: LDW21-GT13-GB-0-11 ft  
 Visual Soil Description: brown sand with silt  
 Type of Specimen: Remolded Cylindrical Shear Box  
 Specimen Diameter (in): 2.5  
 Specimen Height (in): 1  
 Rate of Strain (in/min): 0.0208  
 Estimated Specific Gravity of Solids: 2.65

Summary of Sample Data: $\sigma_n=500$ PSF		
Initial Moisture Content (%)	32.6	
	Initial	Post-Consolidation
Dry Density (PCF):	104.7	106.1
Void Ratio:	0.608	0.589
Porosity (%):	37.8	37.0
Degree of Saturation (%):	saturated	saturated

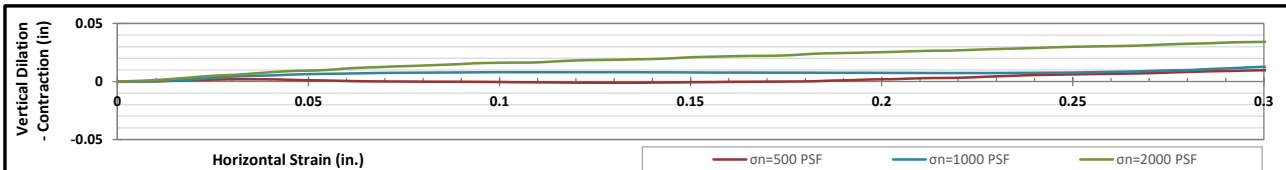
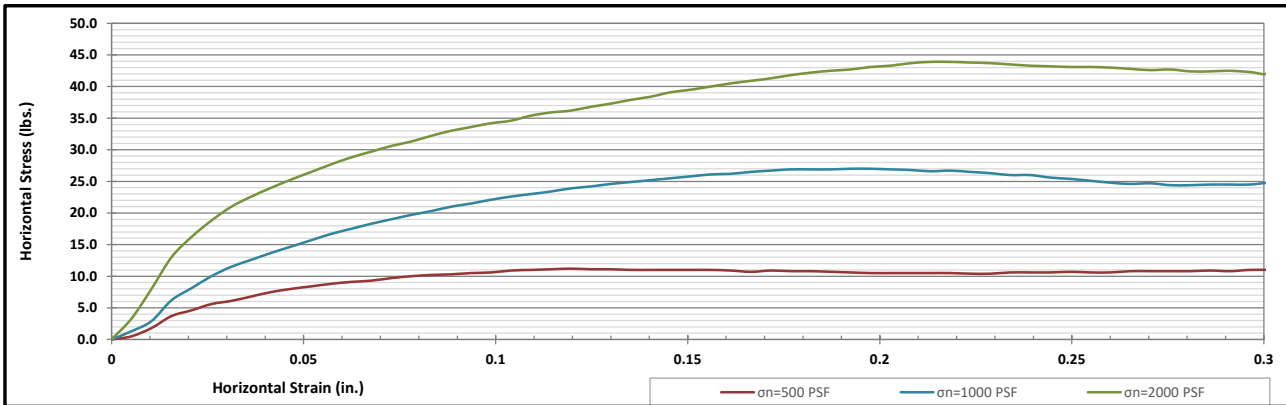
Summary of Sample Data: $\sigma_n=1000$ PSF		
Initial Moisture Content (%)	30.5	
	Initial	Post-Consolidation
Dry Density (PCF):	105.5	108.0
Void Ratio:	0.597	0.560
Porosity (%):	37.4	35.9
Degree of Saturation (%):	saturated	saturated

Summary of Sample Data: $\sigma_n=2000$ PSF		
Initial Moisture Content (%)	31.4	
	Initial	Post-Consolidation
Dry Density (PCF):	105.7	113.8
Void Ratio:	0.595	0.481
Porosity (%):	37.3	32.5
Degree of Saturation (%):	saturated	saturated

ESTIMATED STRENGTH PARAMETERS		
	PEAK	RESIDUAL
Angle of Internal Friction, $\phi$ (°):	35	32
Cohesion (PSF):	0	0



Failure Envelope Test Values:			
Normal Stress, $\sigma_n$ (PSF):	500	1000	2000
Peak Horizontal Stress, $\tau_h$ (PSF):	330	790	1360
Residual Horizontal Stress, $\tau_r$ (PSF):	290	700	1230



Corporate • 777 Chrysler Drive • Burlington, WA 98233 • Phone 360.755.1990 • Fax 360.755.1980  
 SW Region • 2118 Black Lake Blvd. S.W. • Olympia, WA 98512 • Phone 360.534.9777 • Fax 360.534.9779  
 NW Region • 805 Dupont, Suite #5 • Bellingham, WA 98225 • Phone 360.647.6061 • Fax 360.647.8111  
 Kitsap Region • 5451 N.W. Newberry Hill Road, Suite 101 • Silverdale, WA 98383 • Phone/Fax 360.698.6787

Visit our website: [www.mtc-inc.net](http://www.mtc-inc.net)

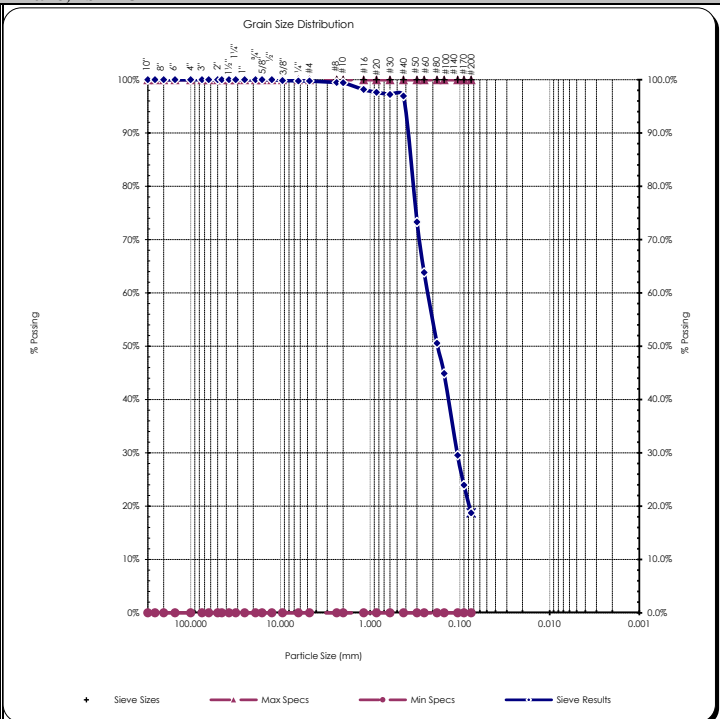


# Sieve Report

<b>Project:</b> Q.C. - Lower Duwamish Waterway <b>Project #:</b> 21B233 <b>Client:</b> Anchor QEA <b>Source:</b> LDW21-GT13-GB-11-21 ft <b>Sample#:</b> B21-1566	<b>Date Received:</b> 29-Jul-21 <b>Sampled By:</b> Client <b>Date Tested:</b> 1-Sep-21 <b>Tested By:</b> C. Kriss	<b>Unified Soil Classification System, ASTM-2487</b> SM, Silty Sand <b>Sample Color:</b> brown	 Certificate #: 1366.01
--	--	---	----------------------------

<b>ASTM D2216, ASTM D2419, ASTM D4318, ASTM D5281</b>			
<b>Specifications</b> No Specs <b>Sample Meets Specs ? N/A</b>	D <sub>(5)</sub> = 0.020 mm D <sub>(10)</sub> = 0.040 mm D <sub>(15)</sub> = 0.060 mm D <sub>(30)</sub> = 0.107 mm D <sub>(50)</sub> = 0.177 mm D <sub>(60)</sub> = 0.230 mm D <sub>(90)</sub> = 0.388 mm Dust Ratio = 17/88	% Gravel = 0.3% % Sand = 81.0% % Silt & Clay = 18.7% Liquid Limit = n/a Plasticity Index = n/a Sand Equivalent = n/a Fracture %, 1 Face = n/a Fracture %, 2+ Faces = n/a	Coeff. of Curvature, C <sub>c</sub> = 1.25 Coeff. of Uniformity, C <sub>u</sub> = 5.74 Fineness Modulus = 0.87 Plastic Limit = n/a Moisture %, as sampled = 36.0% Req'd Sand Equivalent = Req'd Fracture %, 1 Face = Req'd Fracture %, 2+ Faces =

<b>ASTM C136, ASTM D6913, ASTM C117</b>					
Sieve Size		Actual Cumulative Percent Passing	Interpolated Cumulative Percent Passing	Specs Max	Specs Min
US	Metric				
12.00"	300.00		100%	100.0%	0.0%
10.00"	250.00		100%	100.0%	0.0%
8.00"	200.00		100%	100.0%	0.0%
6.00"	150.00		100%	100.0%	0.0%
4.00"	100.00		100%	100.0%	0.0%
3.00"	75.00		100%	100.0%	0.0%
2.50"	63.00		100%	100.0%	0.0%
2.00"	50.00	100%	100%	100.0%	0.0%
1.75"	45.00	100%	100%	100.0%	0.0%
1.50"	37.50	100%	100%	100.0%	0.0%
1.25"	31.50	100%	100%	100.0%	0.0%
1.00"	25.00	100%	100%	100.0%	0.0%
3/4"	19.00	100%	100%	100.0%	0.0%
5/8"	16.00	100%	100%	100.0%	0.0%
1/2"	12.50	100%	100%	100.0%	0.0%
3/8"	9.50	100%	100%	100.0%	0.0%
1/4"	6.30	100%	100%	100.0%	0.0%
#4	4.75	100%	100%	100.0%	0.0%
#8	2.36	99%	99%	100.0%	0.0%
#10	2.00	99%	99%	100.0%	0.0%
#16	1.18	98%	98%	100.0%	0.0%
#20	0.850	98%	98%	100.0%	0.0%
#30	0.600	97%	97%	100.0%	0.0%
#40	0.425	97%	97%	100.0%	0.0%
#50	0.300	73%	73%	100.0%	0.0%
#60	0.250	64%	64%	100.0%	0.0%
#80	0.180	51%	51%	100.0%	0.0%
#100	0.150	45%	45%	100.0%	0.0%
#140	0.106	30%	30%	100.0%	0.0%
#170	0.090	24%	24%	100.0%	0.0%
#200	0.075	18.7%	18.7%	100.0%	0.0%



Copyright Spears Engineering & Technical Services PS, 1996-98  
 All results apply only to actual locations and materials tested. As a mutual protection to clients, the public and ourselves, all reports are submitted as the confidential property of clients, and authorization for publication of statements, conclusions or extracts from or regarding our reports is reserved pending our written approval.

**Comments:** \_\_\_\_\_

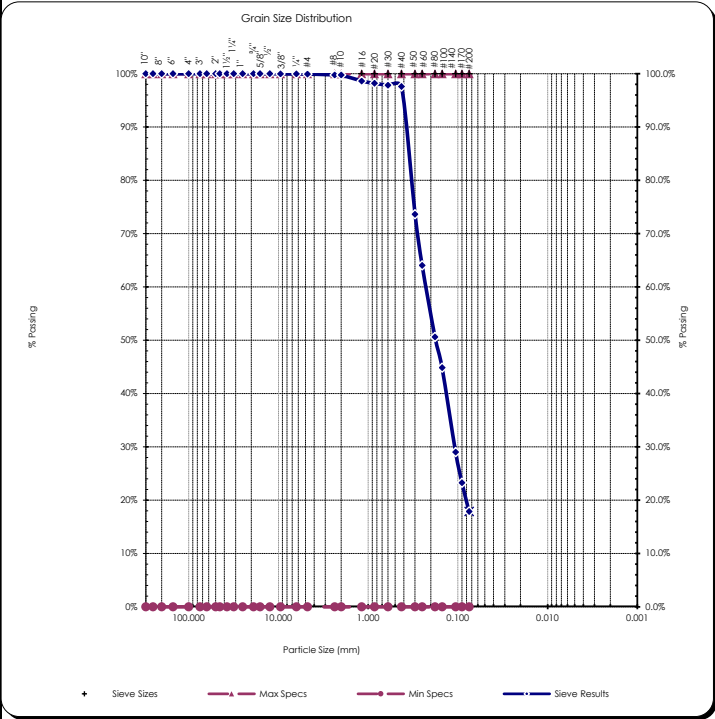
Reviewed by:   
 Meghan Blodgett-Carrillo

# Sieve Report

<b>Project:</b> Q.C. - Lower Duwamish Waterway <b>Project #:</b> 21B233 <b>Client:</b> Anchor QEA <b>Source:</b> LDW21-GT13-GB-21-31 ft <b>Sample#:</b> B21-1568	<b>Date Received:</b> 29-Jul-21 <b>Sampled By:</b> Client <b>Date Tested:</b> 1-Sep-21 <b>Tested By:</b> C. Kriss	<b>Unified Soil Classification System, ASTM-2487</b> SM, Silty Sand <b>Sample Color:</b> brown	 <b>ACCREDITED</b> Certificate #: 1366.01
--	--	---	---

<b>ASTM D2216, ASTM D2419, ASTM D4318, ASTM D5281</b>			
<b>Specifications</b> No Specs <b>Sample Meets Specs ?</b> N/A	D <sub>(5)</sub> = 0.021 mm D <sub>(10)</sub> = 0.042 mm D <sub>(15)</sub> = 0.063 mm D <sub>(30)</sub> = 0.109 mm D <sub>(50)</sub> = 0.177 mm D <sub>(60)</sub> = 0.229 mm D <sub>(90)</sub> = 0.385 mm Dust Ratio = 13/71	% Gravel = 0.1% % Sand = 82.1% % Silt & Clay = 17.9% Liquid Limit = n/a Plasticity Index = n/a Sand Equivalent = n/a Fracture %, 1 Face = n/a Fracture %, 2+ Faces = n/a	Coeff. of Curvature, C <sub>c</sub> = 1.23 Coeff. of Uniformity, C <sub>u</sub> = 5.46 Fineness Modulus = 0.85 Plastic Limit = n/a Moisture %, as sampled = 34.3% Req'd Sand Equivalent = Req'd Fracture %, 1 Face = Req'd Fracture %, 2+ Faces =

<b>ASTM C136, ASTM D6913, ASTM C117</b>					
Sieve Size		Actual Cumulative Percent Passing	Interpolated Cumulative Percent Passing	Specs Max	Specs Min
US	Metric				
12.00"	300.00		100%	100.0%	0.0%
10.00"	250.00		100%	100.0%	0.0%
8.00"	200.00		100%	100.0%	0.0%
6.00"	150.00		100%	100.0%	0.0%
4.00"	100.00		100%	100.0%	0.0%
3.00"	75.00		100%	100.0%	0.0%
2.50"	63.00		100%	100.0%	0.0%
2.00"	50.00	100%	100%	100.0%	0.0%
1.75"	45.00	100%	100%	100.0%	0.0%
1.50"	37.50	100%	100%	100.0%	0.0%
1.25"	31.50	100%	100%	100.0%	0.0%
1.00"	25.00	100%	100%	100.0%	0.0%
3/4"	19.00	100%	100%	100.0%	0.0%
5/8"	16.00	100%	100%	100.0%	0.0%
1/2"	12.50	100%	100%	100.0%	0.0%
3/8"	9.50	100%	100%	100.0%	0.0%
1/4"	6.30	100%	100%	100.0%	0.0%
#4	4.75	100%	100%	100.0%	0.0%
#8	2.36	100%	100%	100.0%	0.0%
#10	2.00	100%	100%	100.0%	0.0%
#16	1.18	99%	100%	100.0%	0.0%
#20	0.850	98%	100%	100.0%	0.0%
#30	0.600	98%	100%	100.0%	0.0%
#40	0.425	98%	98%	100.0%	0.0%
#50	0.300	74%	74%	100.0%	0.0%
#60	0.250	64%	64%	100.0%	0.0%
#80	0.180	51%	51%	100.0%	0.0%
#100	0.150	45%	45%	100.0%	0.0%
#140	0.106	29%	29%	100.0%	0.0%
#170	0.090	23%	23%	100.0%	0.0%
#200	0.075	17.9%	17.9%	100.0%	0.0%



Copyright Spears Engineering & Technical Services PS, 1996-98

All results apply only to actual locations and materials tested. As a mutual protection to clients, the public and ourselves, all reports are submitted as the confidential property of clients, and authorization for publication of statements, conclusions or extracts from or regarding our reports is reserved pending our written approval.

**Comments:** \_\_\_\_\_

Reviewed by:   
 Meghan Blodgett-Carrillo

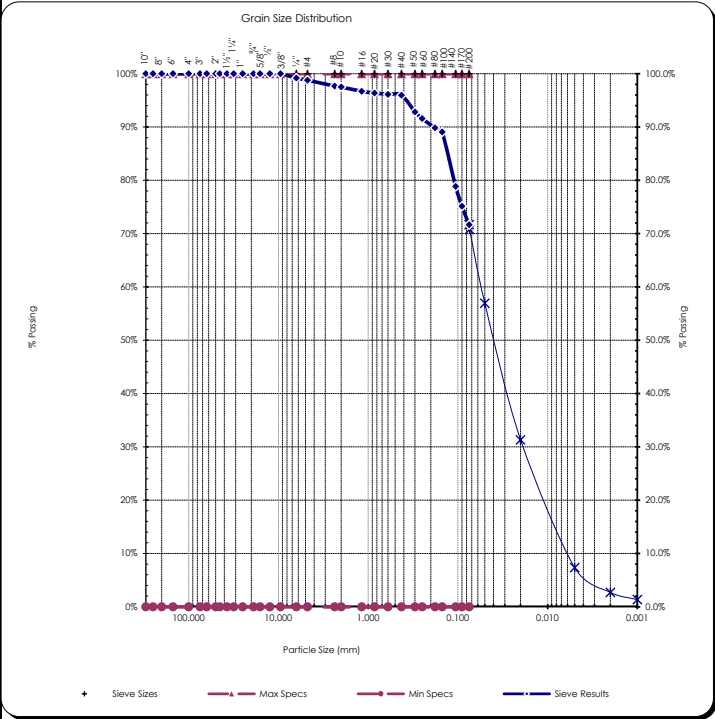


# Sieve Report

<b>Project:</b> Q.C. - Lower Duwamish Waterway <b>Project #:</b> 21B233 <b>Client:</b> Anchor QEA <b>Source:</b> LDW21-GT19-GB-0-6.9 ft <b>Sample#:</b> B21-1571	<b>Date Received:</b> 29-Jul-21 <b>Sampled By:</b> Client <b>Date Tested:</b> 1-Sep-21 <b>Tested By:</b> C. Kriss	<b>Unified Soil Classification System, ASTM-2487</b> ML, Silt with Sand <b>Sample Color:</b> brown	 <b>ACCREDITED</b> Certificate #: 1366.01
--	--	---	---

<b>ASTM D2216, ASTM D2419, ASTM D4318, ASTM D5281</b>			
<b>Specifications</b> No Specs <b>Sample Meets Specs ? N/A</b>	D <sub>(5)</sub> = 0.004 mm D <sub>(10)</sub> = 0.007 mm D <sub>(15)</sub> = 0.009 mm D <sub>(30)</sub> = 0.019 mm D <sub>(50)</sub> = 0.051 mm D <sub>(60)</sub> = 0.062 mm D <sub>(90)</sub> = 0.186 mm Dust Ratio = 59/79	% Gravel = 1.2% % Sand = 27.1% % Silt & Clay = 71.7% Liquid Limit = 0.0% Plasticity Index = 0.0% Sand Equivalent = n/a Fracture %, 1 Face = n/a Fracture %, 2+ Faces = n/a	Coeff. of Curvature, C <sub>c</sub> = 0.88 Coeff. of Uniformity, C <sub>u</sub> = 9.46 Fineness Modulus = 0.29 Plastic Limit = 0.0% Moisture %, as sampled = 78.2% Req'd Sand Equivalent = Req'd Fracture %, 1 Face = Req'd Fracture %, 2+ Faces =

<b>ASTM C136, ASTM D6913, ASTM C117</b>					
Sieve Size		Actual Cumulative Percent Passing	Interpolated Cumulative Percent Passing	Specs Max	Specs Min
US	Metric				
12.00"	300.00		100%	100.0%	0.0%
10.00"	250.00		100%	100.0%	0.0%
8.00"	200.00		100%	100.0%	0.0%
6.00"	150.00		100%	100.0%	0.0%
4.00"	100.00		100%	100.0%	0.0%
3.00"	75.00		100%	100.0%	0.0%
2.50"	63.00		100%	100.0%	0.0%
2.00"	50.00	100%	100%	100.0%	0.0%
1.75"	45.00	100%	100%	100.0%	0.0%
1.50"	37.50	100%	100%	100.0%	0.0%
1.25"	31.50	100%	100%	100.0%	0.0%
1.00"	25.00	100%	100%	100.0%	0.0%
3/4"	19.00	100%	100%	100.0%	0.0%
5/8"	16.00	100%	100%	100.0%	0.0%
1/2"	12.50	100%	100%	100.0%	0.0%
3/8"	9.50	100%	100%	100.0%	0.0%
1/4"	6.30	99%	99%	100.0%	0.0%
#4	4.75	99%	99%	100.0%	0.0%
#8	2.36	98%	98%	100.0%	0.0%
#10	2.00	98%	98%	100.0%	0.0%
#16	1.18	97%	97%	100.0%	0.0%
#20	0.850	96%	96%	100.0%	0.0%
#30	0.600	96%	96%	100.0%	0.0%
#40	0.425	96%	96%	100.0%	0.0%
#50	0.300	93%	93%	100.0%	0.0%
#60	0.250	92%	92%	100.0%	0.0%
#80	0.180	90%	90%	100.0%	0.0%
#100	0.150	89%	89%	100.0%	0.0%
#140	0.106	79%	79%	100.0%	0.0%
#170	0.090	75%	75%	100.0%	0.0%
#200	0.075	71.7%	71.7%	100.0%	0.0%




Copyright Spears Engineering & Technical Services PS, 1996-98  
 All results apply only to actual locations and materials tested. As a mutual protection to clients, the public and ourselves, all reports are submitted as the confidential property of clients, and authorization for publication of statements, conclusions or extracts from or regarding our reports is reserved pending our written approval.

**Comments:** \_\_\_\_\_

Reviewed by:   
 Meghan Blodgett-Carrillo

## Hydrometer Report

<p><b>Project:</b> Q.C. - Lower Duwamish Waterway    <b>Date Received:</b> 29-Jul-21  <b>Project #:</b> 21B233    <b>Sampled By:</b> Client  <b>Client:</b> Anchor QEA    <b>Date Tested:</b> 1-Sep-21  <b>Source:</b> LDW21-GT19-GB-0-6.9 ft    <b>Tested By:</b> C. Kriss  <b>Sample#:</b> B21-1571</p>	<p><b>Unified Soil Classification System, ASTM-2487</b>  ML, Silt with Sand  <b>Sample Color</b>  brown</p>																																																																																																									
<b>ASTM D7928, HYDROMETER ANALYSIS</b>	<b>ASTM D6913</b>																																																																																																									
<p>Sp Gr : 2.61  Sample Weight: 50.97 grams  Hydroscopic Moist.: 2.35%  Adj. Sample Wgt : 49.80 grams</p> <div style="text-align: center;">  </div> <table style="width: 100%; border-collapse: collapse;"> <thead> <tr> <th style="text-align: left;">Hydrometer Reading</th> <th style="text-align: left;">Corrected Reading</th> <th style="text-align: left;">Percent Passing</th> <th style="text-align: left;">Soils Particle Diameter</th> </tr> </thead> <tbody> <tr><td>1</td><td>24.5</td><td>48.4%</td><td>0.0488 mm</td></tr> <tr><td>2</td><td>19.5</td><td>38.6%</td><td>0.0356 mm</td></tr> <tr><td>5</td><td>17.5</td><td>34.6%</td><td>0.0228 mm</td></tr> <tr><td>15</td><td>12</td><td>23.7%</td><td>0.0135 mm</td></tr> <tr><td>30</td><td>9</td><td>17.8%</td><td>0.0097 mm</td></tr> <tr><td>60</td><td>5.5</td><td>10.9%</td><td>0.0070 mm</td></tr> <tr><td>240</td><td>2.5</td><td>4.9%</td><td>0.0036 mm</td></tr> <tr><td>1440</td><td>1</td><td>2.0%</td><td>0.0015 mm</td></tr> </tbody> </table> <p>% Gravel: 1.2%                                    <b>Liquid Limit:</b> 0.0 %  % Sand: 27.1%                                    <b>Plastic Limit:</b> 0.0 %  % Silt: 64.3%                                    <b>Plasticity Index:</b> 0.0 %  % Clay: 7.4%</p>	Hydrometer Reading	Corrected Reading	Percent Passing	Soils Particle Diameter	1	24.5	48.4%	0.0488 mm	2	19.5	38.6%	0.0356 mm	5	17.5	34.6%	0.0228 mm	15	12	23.7%	0.0135 mm	30	9	17.8%	0.0097 mm	60	5.5	10.9%	0.0070 mm	240	2.5	4.9%	0.0036 mm	1440	1	2.0%	0.0015 mm	<p style="text-align: center;"><b>Sieve Analysis</b>  <b>Grain Size Distribution</b></p> <table style="width: 100%; border-collapse: collapse;"> <thead> <tr> <th style="text-align: left;">Sieve Size</th> <th style="text-align: left;">Percent Passing</th> <th style="text-align: left;">Soils Particle Diameter</th> </tr> </thead> <tbody> <tr><td>3.0"</td><td>100%</td><td>75.000 mm</td></tr> <tr><td>2.0"</td><td>100%</td><td>50.000 mm</td></tr> <tr><td>1.5"</td><td>100%</td><td>37.500 mm</td></tr> <tr><td>1.25"</td><td>100%</td><td>31.500 mm</td></tr> <tr><td>1.0"</td><td>100%</td><td>25.000 mm</td></tr> <tr><td>3/4"</td><td>100%</td><td>19.000 mm</td></tr> <tr><td>5/8"</td><td>100%</td><td>16.000 mm</td></tr> <tr><td>1/2"</td><td>100%</td><td>12.500 mm</td></tr> <tr><td>3/8"</td><td>100%</td><td>9.500 mm</td></tr> <tr><td>1/4"</td><td>99%</td><td>6.300 mm</td></tr> <tr><td>#4</td><td>99%</td><td>4.750 mm</td></tr> <tr><td>#10</td><td>98%</td><td>2.000 mm</td></tr> <tr><td>#20</td><td>96%</td><td>0.850 mm</td></tr> <tr><td>#40</td><td>96%</td><td>0.425 mm</td></tr> <tr><td>#100</td><td>89%</td><td>0.150 mm</td></tr> <tr><td>#200</td><td>71.7%</td><td>0.075 mm</td></tr> <tr><td style="padding-left: 20px;"><b>Silts</b></td><td>70.8%</td><td>0.074 mm</td></tr> <tr><td></td><td>56.9%</td><td>0.050 mm</td></tr> <tr><td></td><td>31.3%</td><td>0.020 mm</td></tr> <tr><td style="padding-left: 20px;"><b>Clays</b></td><td>7.4%</td><td>0.005 mm</td></tr> <tr><td></td><td>2.7%</td><td>0.002 mm</td></tr> <tr><td style="padding-left: 20px;"><b>Colloids</b></td><td>1.3%</td><td>0.001 mm</td></tr> </tbody> </table>	Sieve Size	Percent Passing	Soils Particle Diameter	3.0"	100%	75.000 mm	2.0"	100%	50.000 mm	1.5"	100%	37.500 mm	1.25"	100%	31.500 mm	1.0"	100%	25.000 mm	3/4"	100%	19.000 mm	5/8"	100%	16.000 mm	1/2"	100%	12.500 mm	3/8"	100%	9.500 mm	1/4"	99%	6.300 mm	#4	99%	4.750 mm	#10	98%	2.000 mm	#20	96%	0.850 mm	#40	96%	0.425 mm	#100	89%	0.150 mm	#200	71.7%	0.075 mm	<b>Silts</b>	70.8%	0.074 mm		56.9%	0.050 mm		31.3%	0.020 mm	<b>Clays</b>	7.4%	0.005 mm		2.7%	0.002 mm	<b>Colloids</b>	1.3%	0.001 mm
Hydrometer Reading	Corrected Reading	Percent Passing	Soils Particle Diameter																																																																																																							
1	24.5	48.4%	0.0488 mm																																																																																																							
2	19.5	38.6%	0.0356 mm																																																																																																							
5	17.5	34.6%	0.0228 mm																																																																																																							
15	12	23.7%	0.0135 mm																																																																																																							
30	9	17.8%	0.0097 mm																																																																																																							
60	5.5	10.9%	0.0070 mm																																																																																																							
240	2.5	4.9%	0.0036 mm																																																																																																							
1440	1	2.0%	0.0015 mm																																																																																																							
Sieve Size	Percent Passing	Soils Particle Diameter																																																																																																								
3.0"	100%	75.000 mm																																																																																																								
2.0"	100%	50.000 mm																																																																																																								
1.5"	100%	37.500 mm																																																																																																								
1.25"	100%	31.500 mm																																																																																																								
1.0"	100%	25.000 mm																																																																																																								
3/4"	100%	19.000 mm																																																																																																								
5/8"	100%	16.000 mm																																																																																																								
1/2"	100%	12.500 mm																																																																																																								
3/8"	100%	9.500 mm																																																																																																								
1/4"	99%	6.300 mm																																																																																																								
#4	99%	4.750 mm																																																																																																								
#10	98%	2.000 mm																																																																																																								
#20	96%	0.850 mm																																																																																																								
#40	96%	0.425 mm																																																																																																								
#100	89%	0.150 mm																																																																																																								
#200	71.7%	0.075 mm																																																																																																								
<b>Silts</b>	70.8%	0.074 mm																																																																																																								
	56.9%	0.050 mm																																																																																																								
	31.3%	0.020 mm																																																																																																								
<b>Clays</b>	7.4%	0.005 mm																																																																																																								
	2.7%	0.002 mm																																																																																																								
<b>Colloids</b>	1.3%	0.001 mm																																																																																																								
<b>USDA Soil Textural Classification</b>																																																																																																										
<table style="width: 100%; border-collapse: collapse;"> <tr> <td style="width: 50%;"></td> <td style="text-align: center;"><b>Particle Size</b></td> </tr> <tr> <td>% Sand:</td> <td style="text-align: center;">2.0 - 0.05 mm</td> </tr> <tr> <td>% Silt:</td> <td style="text-align: center;">0.05 - 0.002 mm</td> </tr> <tr> <td>% Clay:</td> <td style="text-align: center;">&lt; 0.002 mm</td> </tr> </table> <p style="text-align: center;"><b>USDA Soil Textural Classification</b> Silt Loam</p>		<b>Particle Size</b>	% Sand:	2.0 - 0.05 mm	% Silt:	0.05 - 0.002 mm	% Clay:	< 0.002 mm																																																																																																		
	<b>Particle Size</b>																																																																																																									
% Sand:	2.0 - 0.05 mm																																																																																																									
% Silt:	0.05 - 0.002 mm																																																																																																									
% Clay:	< 0.002 mm																																																																																																									

All results apply only to actual locations and materials tested. As a mutual protection to clients, the public and ourselves, all reports are submitted as the confidential property of clients, and authorization for publication of statements, conclusions or extracts from or regarding our reports is reserved pending our written approval.

**Comments:** \_\_\_\_\_  
\_\_\_\_\_  
\_\_\_\_\_

**Reviewed by:**   
\_\_\_\_\_   
Meghan Blodgett-Carrillo



## ASTM D4318 - Liquid Limit, Plastic Limit and Plasticity Index of Soils

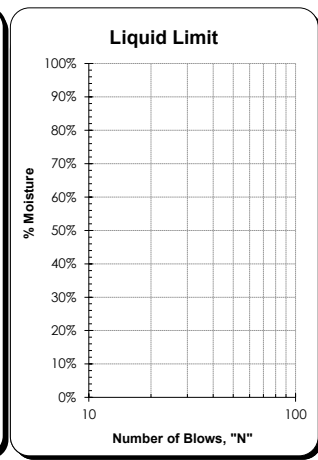
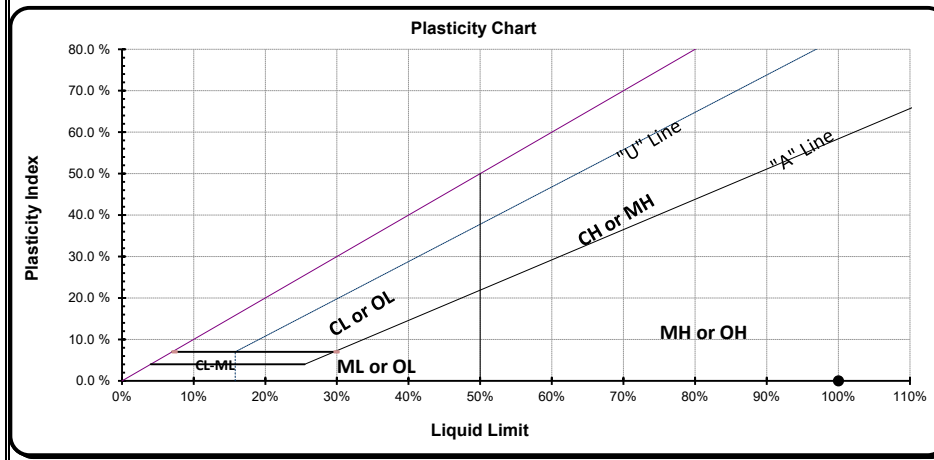
<b>Project:</b> Q.C. - Lower Duwamish Waterway <b>Project #:</b> 21B233 <b>Client:</b> Anchor QEA <b>Source:</b> LDW21-GT19-GB-0-6.9 ft <b>Sample #:</b> B21-1571	<b>Date Received:</b> 29-Jul-21 <b>Sampled By:</b> Client <b>Date Tested:</b> 1-Sep-21 <b>Tested By:</b> C. Kriss	<b>Unified Soils Classification System, ASTM D-2487</b> ML, Silt with Sand <b>Sample Color</b> brown
---	--	---

Liquid Limit Determination						
	#1	#2	#3	#4	#5	#6
Weight of Wet Soils + Pan:	Liquid limit cannot be established					
Weight of Dry Soils + Pan:						
Weight of Pan:						
Weight of Dry Soils:						
Weight of Moisture:						
% Moisture:						
Number of Blows:						



**Liquid Limit @ 25 Blows:** N/A  
**Plastic Limit:** N/A  
**Plasticity Index, I<sub>p</sub>:** N/A

Plastic Limit Determination						
	#1	#2	#3	#4	#5	#6
Weight of Wet Soils + Pan:	Plastic limit cannot be determined					
Weight of Dry Soils + Pan:						
Weight of Pan:						
Weight of Dry Soils:						
Weight of Moisture:						
% Moisture:						




Copyright Spears Engineering & Technical Services PS, 1996-98  
 All results apply only to actual locations and materials tested. As a mutual protection to clients, the public and ourselves, all reports are submitted as the confidential property of clients, and authorization for publication of statements, conclusions or extracts from or regarding our reports is reserved pending our written approval.

**Comments:** Liquid limit cannot be established as the material displays rapid dilation upon spreading into the cup. At lower moistures the material does not spread into the liquid limit cup without tearing the soil cake. Plastic limit cannot be determined as the material does not roll down to 1/8" threads before cracking or crumbling. Non-plastic.

Reviewed by:   
 \_\_\_\_\_  
 Meghan Blodgett-Carrillo

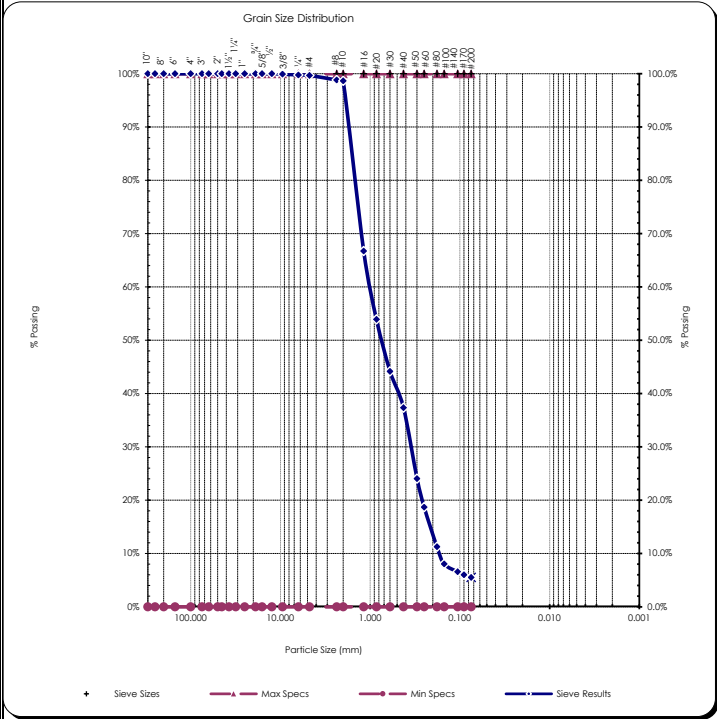


# Sieve Report

<b>Project:</b> Q.C. - Lower Duwamish Waterway <b>Project #:</b> 21B233 <b>Client:</b> Anchor QEA <b>Source:</b> LDW21-GT19-GB-6.9-8.5 ft <b>Sample#:</b> B21-1572	<b>Date Received:</b> 29-Jul-21 <b>Sampled By:</b> Client <b>Date Tested:</b> 1-Sep-21 <b>Tested By:</b> C. Kriss	<b>Unified Soil Classification System, ASTM-2487</b> SP-SM, Poorly graded Sand with Silt <b>Sample Color:</b> brown	 <b>ACCREDITED</b> Certificate #: 1366.01
--	--	--	--

<b>ASTM D2216, ASTM D2419, ASTM D4318, ASTM D5281</b>			
<b>Specifications</b> No Specs <b>Sample Meets Specs ?</b> N/A	D <sub>(5)</sub> = 0.068 mm D <sub>(10)</sub> = 0.168 mm D <sub>(15)</sub> = 0.215 mm D <sub>(30)</sub> = 0.356 mm D <sub>(50)</sub> = 0.749 mm D <sub>(60)</sub> = 1.006 mm D <sub>(90)</sub> = 1.777 mm Dust Ratio = 9/61	% Gravel = 0.3% % Sand = 94.2% % Silt & Clay = 5.5% Liquid Limit = n/a Plasticity Index = n/a Sand Equivalent = n/a Fracture %, 1 Face = n/a Fracture %, 2+ Faces = n/a	Coeff. of Curvature, C <sub>c</sub> = 0.75 Coeff. of Uniformity, C <sub>u</sub> = 5.98 Fineness Modulus = 2.59 Plastic Limit = n/a Moisture %, as sampled = 27.9% Req'd Sand Equivalent = Req'd Fracture %, 1 Face = Req'd Fracture %, 2+ Faces =

<b>ASTM C136, ASTM D6913, ASTM C117</b>					
<b>Sieve Size</b>		<b>Actual Cumulative Percent Passing</b>	<b>Interpolated Cumulative Percent Passing</b>	<b>Specs Max</b>	<b>Specs Min</b>
<b>US</b>	<b>Metric</b>				
12.00"	300.00		100%	100.0%	0.0%
10.00"	250.00		100%	100.0%	0.0%
8.00"	200.00		100%	100.0%	0.0%
6.00"	150.00		100%	100.0%	0.0%
4.00"	100.00		100%	100.0%	0.0%
3.00"	75.00		100%	100.0%	0.0%
2.50"	63.00		100%	100.0%	0.0%
2.00"	50.00	100%	100%	100.0%	0.0%
1.75"	45.00	100%	100%	100.0%	0.0%
1.50"	37.50	100%	100%	100.0%	0.0%
1.25"	31.50	100%	100%	100.0%	0.0%
1.00"	25.00	100%	100%	100.0%	0.0%
3/4"	19.00	100%	100%	100.0%	0.0%
5/8"	16.00	100%	100%	100.0%	0.0%
1/2"	12.50	100%	100%	100.0%	0.0%
3/8"	9.50	100%	100%	100.0%	0.0%
1/4"	6.30	100%	100%	100.0%	0.0%
#4	4.75	100%	100%	100.0%	0.0%
#8	2.36		99%	100.0%	0.0%
#10	2.00	99%	99%	100.0%	0.0%
#16	1.18		67%	100.0%	0.0%
#20	0.850		54%	100.0%	0.0%
#30	0.600		44%	100.0%	0.0%
#40	0.425	37%	37%	100.0%	0.0%
#50	0.300		24%	100.0%	0.0%
#60	0.250		19%	100.0%	0.0%
#80	0.180		11%	100.0%	0.0%
#100	0.150	8%	8%	100.0%	0.0%
#140	0.106		7%	100.0%	0.0%
#170	0.090		6%	100.0%	0.0%
#200	0.075	5.5%	5.5%	100.0%	0.0%



Copyright Spears Engineering & Technical Services PS, 1996-98  
 All results apply only to actual locations and materials tested. As a mutual protection to clients, the public and ourselves, all reports are submitted as the confidential property of clients, and authorization for publication of statements, conclusions or extracts from or regarding our reports is reserved pending our written approval.

**Comments:** \_\_\_\_\_

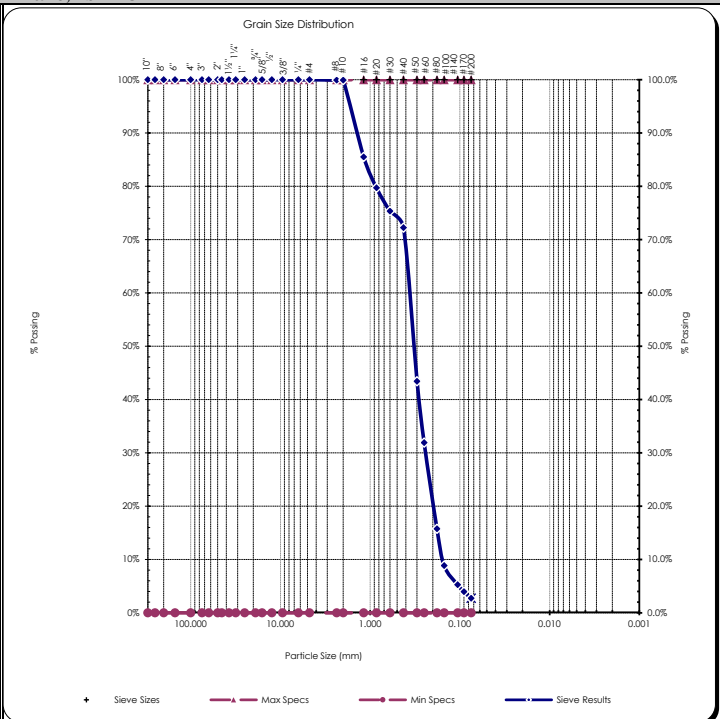
Reviewed by: Meghan Blodgett-Carrillo  
 Meghan Blodgett-Carrillo

# Sieve Report

<b>Project:</b> Q.C. - Lower Duwamish Waterway <b>Project #:</b> 21B233 <b>Client:</b> Anchor QEA <b>Source:</b> LDW21-GT19-GB-8.5-18.5 ft <b>Sample#:</b> B21-1574	<b>Date Received:</b> 29-Jul-21 <b>Sampled By:</b> Client <b>Date Tested:</b> 1-Sep-21 <b>Tested By:</b> C. Kriss	<b>Unified Soil Classification System, ASTM-2487</b> SP, Poorly graded Sand <b>Sample Color:</b> brown	 <b>ACCREDITED</b> Certificate #: 1366.01
---	--	---	---

<b>ASTM D2216, ASTM D2419, ASTM D4318, ASTM D5281</b>			
<b>Specifications</b> No Specs <b>Sample Meets Specs ?</b> N/A	D <sub>(5)</sub> = 0.103 mm D <sub>(10)</sub> = 0.155 mm D <sub>(15)</sub> = 0.177 mm D <sub>(30)</sub> = 0.242 mm D <sub>(50)</sub> = 0.328 mm D <sub>(60)</sub> = 0.372 mm D <sub>(90)</sub> = 1.435 mm Dust Ratio = 2/53	% Gravel = 0.0% % Sand = 97.3% % Silt & Clay = 2.7% Liquid Limit = n/a Plasticity Index = n/a Sand Equivalent = n/a Fracture %, 1 Face = n/a Fracture %, 2+ Faces = n/a	Coeff. of Curvature, C <sub>c</sub> = 1.01 Coeff. of Uniformity, C <sub>u</sub> = 2.40 Fineness Modulus = 1.87 Plastic Limit = n/a Moisture %, as sampled = 25.2% Req'd Sand Equivalent = Req'd Fracture %, 1 Face = Req'd Fracture %, 2+ Faces =

<b>ASTM C136, ASTM D6913, ASTM C117</b>					
Sieve Size		Actual Cumulative Percent Passing	Interpolated Cumulative Percent Passing	Specs Max	Specs Min
US	Metric				
12.00"	300.00		100%	100.0%	0.0%
10.00"	250.00		100%	100.0%	0.0%
8.00"	200.00		100%	100.0%	0.0%
6.00"	150.00		100%	100.0%	0.0%
4.00"	100.00		100%	100.0%	0.0%
3.00"	75.00		100%	100.0%	0.0%
2.50"	63.00		100%	100.0%	0.0%
2.00"	50.00	100%	100%	100.0%	0.0%
1.75"	45.00	100%	100%	100.0%	0.0%
1.50"	37.50	100%	100%	100.0%	0.0%
1.25"	31.50	100%	100%	100.0%	0.0%
1.00"	25.00	100%	100%	100.0%	0.0%
3/4"	19.00	100%	100%	100.0%	0.0%
5/8"	16.00	100%	100%	100.0%	0.0%
1/2"	12.50	100%	100%	100.0%	0.0%
3/8"	9.50	100%	100%	100.0%	0.0%
1/4"	6.30	100%	100%	100.0%	0.0%
#4	4.75	100%	100%	100.0%	0.0%
#8	2.36	100%	100%	100.0%	0.0%
#10	2.00	100%	100%	100.0%	0.0%
#16	1.18	72%	86%	100.0%	0.0%
#20	0.850	72%	80%	100.0%	0.0%
#30	0.600	72%	75%	100.0%	0.0%
#40	0.425	72%	72%	100.0%	0.0%
#50	0.300	72%	43%	100.0%	0.0%
#60	0.250	72%	32%	100.0%	0.0%
#80	0.180	72%	16%	100.0%	0.0%
#100	0.150	9%	9%	100.0%	0.0%
#140	0.106	9%	5%	100.0%	0.0%
#170	0.090	9%	4%	100.0%	0.0%
#200	0.075	2.7%	2.7%	100.0%	0.0%



Copyright Spears Engineering & Technical Services PS, 1996-98  
 All results apply only to actual locations and materials tested. As a mutual protection to clients, the public and ourselves, all reports are submitted as the confidential property of clients, and authorization for publication of statements, conclusions or extracts from or regarding our reports is reserved pending our written approval.

**Comments:** \_\_\_\_\_

Reviewed by:   
 Meghan Blodgett-Carrillo

# Direct Shear Test Results:

ASTM D-3080



Project: Q.C. - Lower Duwamish Waterway  
 Project Number: 21B233  
 Laboratory Sample ID: B21-1574  
 Sample Date: 7/13/2021  
 Test Date: 9/21/2021  
 Technician: M. Carrillo

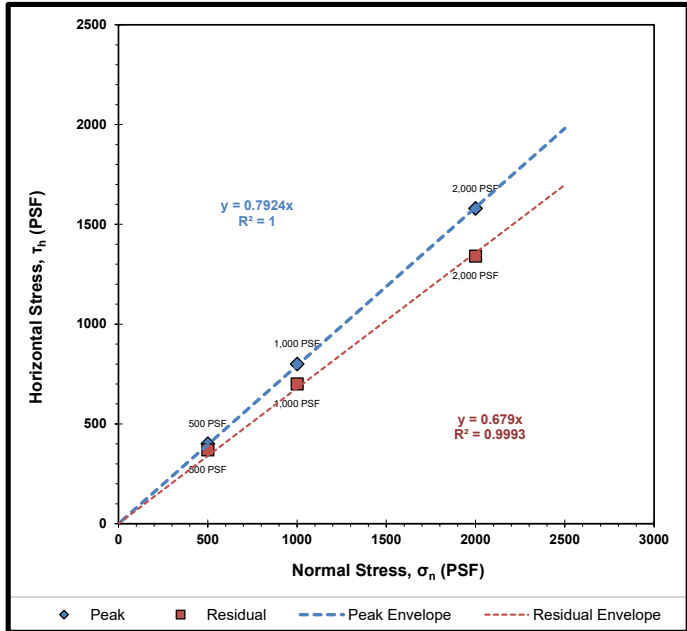
Sample Source: LDW21-GT19-GB-8.5-18.5 ft  
 Visual Soil Description: brown sand with silt  
 Type of Specimen: Remolded Cylindrical Shear Box  
 Specimen Diameter (in): 2.5  
 Specimen Height (in): 1  
 Rate of Strain (in/min): 0.0208  
 Estimated Specific Gravity of Solids: 2.65

Summary of Sample Data: $\sigma_n=500$ PSF		
Initial Moisture Content (%)	27.5	
	Initial	Post-Consolidation
Dry Density (PCF):	106.2	107.3
Void Ratio:	0.586	0.570
Porosity (%):	37.0	36.3
Degree of Saturation (%):	saturated	saturated

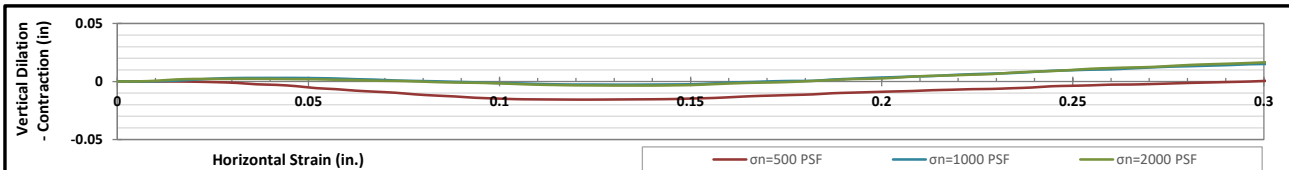
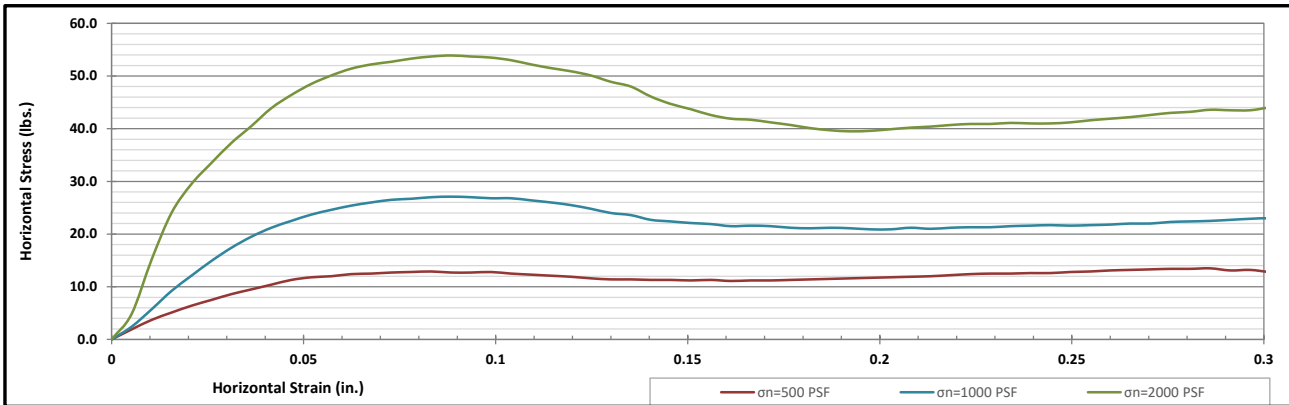
Summary of Sample Data: $\sigma_n=1000$ PSF		
Initial Moisture Content (%)	26.1	
	Initial	Post-Consolidation
Dry Density (PCF):	108.0	109.7
Void Ratio:	0.560	0.536
Porosity (%):	35.9	34.9
Degree of Saturation (%):	saturated	saturated

Summary of Sample Data: $\sigma_n=2000$ PSF		
Initial Moisture Content (%)	24.7	
	Initial	Post-Consolidation
Dry Density (PCF):	109.2	111.5
Void Ratio:	0.543	0.511
Porosity (%):	35.2	33.8
Degree of Saturation (%):	saturated	saturated

ESTIMATED STRENGTH PARAMETERS		
	PEAK	RESIDUAL
Angle of Internal Friction, $\phi$ (°):	38	34
Cohesion (PSF):	0	0



Failure Envelope Test Values:			
Normal Stress, $\sigma_n$ (PSF):	500	1000	2000
Peak Horizontal Stress, $\tau_h$ (PSF):	400	800	1580
Residual Horizontal Stress, $\tau_h$ (PSF):	370	700	1340



Corporate • 777 Chrysler Drive • Burlington, WA 98233 • Phone 360.755.1990 • Fax 360.755.1980  
 SW Region • 2118 Black Lake Blvd. S.W. • Olympia, WA 98512 • Phone 360.534.9777 • Fax 360.534.9779  
 NW Region • 805 Dupont, Suite #5 • Bellingham, WA 98225 • Phone 360.647.6061 • Fax 360.647.8111  
 Kitsap Region • 5451 N.W. Newberry Hill Road, Suite 101 • Silverdale, WA 98383 • Phone/Fax 360.698.6787

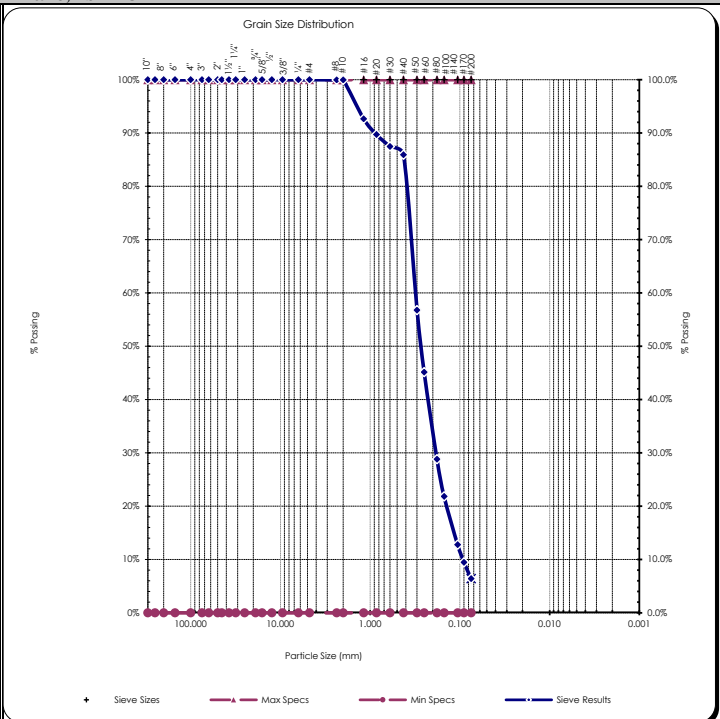
Visit our website: [www.mtc-inc.net](http://www.mtc-inc.net)

# Sieve Report

<b>Project:</b> Q.C. - Lower Duwamish Waterway <b>Project #:</b> 21B233 <b>Client:</b> Anchor QEA <b>Source:</b> LDW21-GT19-GB-18.5-28.5 ft <b>Sample#:</b> B21-1576	<b>Date Received:</b> 29-Jul-21 <b>Sampled By:</b> Client <b>Date Tested:</b> 1-Sep-21 <b>Tested By:</b> C. Kriss	<b>Unified Soil Classification System, ASTM-2487</b> SP-SM, Poorly graded Sand with Silt <b>Sample Color:</b> brown	 <b>ACCREDITED</b> Certificate #: 1366.01
--	--	--	---

<b>ASTM D2216, ASTM D2419, ASTM D4318, ASTM D5281</b>			
<b>Specifications</b> No Specs <b>Sample Meets Specs ?</b> N/A	D <sub>(5)</sub> = 0.058 mm D <sub>(10)</sub> = 0.092 mm D <sub>(15)</sub> = 0.117 mm D <sub>(30)</sub> = 0.185 mm D <sub>(50)</sub> = 0.271 mm D <sub>(60)</sub> = 0.314 mm D <sub>(90)</sub> = 0.882 mm Dust Ratio = 5/67	% Gravel = 0.0% % Sand = 93.6% % Silt & Clay = 6.4% Liquid Limit = n/a Plasticity Index = n/a Sand Equivalent = n/a Fracture %, 1 Face = n/a Fracture %, 2+ Faces = n/a	Coeff. of Curvature, C <sub>c</sub> = 1.18 Coeff. of Uniformity, C <sub>u</sub> = 3.40 Fineness Modulus = 1.41 Plastic Limit = n/a Moisture %, as sampled = 27.7% Req'd Sand Equivalent = Req'd Fracture %, 1 Face = Req'd Fracture %, 2+ Faces =

<b>ASTM C136, ASTM D6913, ASTM C117</b>					
<b>Sieve Size</b>		<b>Actual Cumulative Percent Passing</b>	<b>Interpolated Cumulative Percent Passing</b>	<b>Specs Max</b>	<b>Specs Min</b>
<b>US</b>	<b>Metric</b>				
12.00"	300.00		100%	100.0%	0.0%
10.00"	250.00		100%	100.0%	0.0%
8.00"	200.00		100%	100.0%	0.0%
6.00"	150.00		100%	100.0%	0.0%
4.00"	100.00		100%	100.0%	0.0%
3.00"	75.00		100%	100.0%	0.0%
2.50"	63.00		100%	100.0%	0.0%
2.00"	50.00	100%	100%	100.0%	0.0%
1.75"	45.00	100%	100%	100.0%	0.0%
1.50"	37.50	100%	100%	100.0%	0.0%
1.25"	31.50	100%	100%	100.0%	0.0%
1.00"	25.00	100%	100%	100.0%	0.0%
3/4"	19.00	100%	100%	100.0%	0.0%
5/8"	16.00	100%	100%	100.0%	0.0%
1/2"	12.50	100%	100%	100.0%	0.0%
3/8"	9.50	100%	100%	100.0%	0.0%
1/4"	6.30	100%	100%	100.0%	0.0%
#4	4.75	100%	100%	100.0%	0.0%
#8	2.36	100%	100%	100.0%	0.0%
#10	2.00	100%	100%	100.0%	0.0%
#16	1.18	93%	100%	100.0%	0.0%
#20	0.850	90%	100%	100.0%	0.0%
#30	0.600	87%	100%	100.0%	0.0%
#40	0.425	86%	100%	100.0%	0.0%
#50	0.300	57%	100%	100.0%	0.0%
#60	0.250	45%	100%	100.0%	0.0%
#80	0.180	29%	100%	100.0%	0.0%
#100	0.150	22%	100%	100.0%	0.0%
#140	0.106	13%	100%	100.0%	0.0%
#170	0.090	10%	100%	100.0%	0.0%
#200	0.075	6.4%	6.4%	100.0%	0.0%



Copyright Spears Engineering & Technical Services PS, 1996-98  
 All results apply only to actual locations and materials tested. As a mutual protection to clients, the public and ourselves, all reports are submitted as the confidential property of clients, and authorization for publication of statements, conclusions or extracts from or regarding our reports is reserved pending our written approval.

**Comments:** \_\_\_\_\_

Reviewed by:   
 Meghan Blodgett-Carrillo



**Client:** Anchor QEA  
**Address:** 21328 2nd Drive SE  
Bothell, WA 98021  
**Attn:** Garrett Timm  
**Revised on:** \_\_\_\_\_

**Date:** October 5, 2021  
**Project:** Q.C. - Lower Duwamish Waterway  
**Project #:** 21B233  
**Sample #:** B21-1693-1706  
**Date sampled:** July 14, 2021

As requested MTC, Inc. has performed the following test(s) on the sample referenced above. The testing was performed in accordance with current applicable AASHTO or ASTM standards as indicated below. The results obtained in our laboratory were as follows below or on the attached pages:

	Test(s) Performed:	Test Results		Test(s) Performed:	Test Results
X	Sieve Analysis	Please See Attached Reports		Sulfate Soundness	
	Proctor			Bulk Density & Voids	
	Sand Equivalent			WSDOT Degradation	
	Fracture Count			LA Abrasion	
X	Moisture Content	Please See Attached Report	X	Direct Shear	Please See Attached Reports
	Specific Gravity, Coarse		X	Specific Gravity, Soils	Please See Attached Reports
	Specific Gravity, Fine				
X	Hydrometer Analysis	Please See Attached Reports			
X	Atterberg Limits	Please See Attached Reports			

If you have any questions concerning the test results, the procedures used, or if we can be of any further assistance please call on us at the number below.

Respectfully Submitted,  
 Meghan Blodgett-Carrillo  
 WABO Supervising Laboratory Technician




## Moisture Content - ASTM C566, ASTM D2216

**Project:** Q.C. - Lower Duwamish Waterway  
**Project #:** 21B233  
**Date Received:** July 29, 2021  
**Date Tested:** September 13, 2021

**Client:** Anchor QEA  
**Sampled by:** Client  
**Tested by:** A. Eifrig

Sample #	Location	Tare	Wet + Tare	Dry + Tare	Wgt. Of Moisture	Wgt. Of Soil	% Moisture
B21-1693	LDW21-GT37-GB-0-1.5 ft	233.7	583.3	440.8	142.5	207.1	68.8%
B21-1694	LDW21-GT37-GB-10-11.5 ft	302.0	688.9	534.6	154.3	232.6	66.3%
B21-1695	LDW21-GT37-GB-10-20 ft	234.3	678.9	534.1	144.8	299.8	48.3%
B21-1696	LDW21-GT37-GB-20-21.5 ft	341.8	864.9	644.8	220.1	303.0	72.6%
B21-1697	LDW21-GT37-GB-20-30 ft	316.0	945.0	766.3	178.7	450.3	39.7%
B21-1698	LDW21-GT37-GB-30-31.5 ft	346.9	1041.2	892.0	149.2	545.1	27.4%
B21-1699	LDW21-GT18-GB-0-1.5 ft	360.3	577.1	507.3	69.8	147.0	47.5%
B21-1700	LDW21-GT18-GB-0-6.5 ft	233.5	726.8	590.5	136.3	357.0	38.2%
B21-1701	LDW21-GT18-GB-6.5-8 ft	357.0	752.8	656.6	96.2	299.6	32.1%
B21-1702	LDW21-GT18-GB-6.5-16.5 ft	217.3	795.2	684.7	110.5	467.4	23.6%
B21-1703	LDW21-GT18-GB-16.5-18 ft	354.3	1016.0	893.3	122.7	539.0	22.8%
B21-1704	LDW21-GT18-GB-16.5-21.4 ft	10.2	159.2	118.5	40.7	108.3	37.6%
B21-1705	LDW21-GT18-GB-21.4-26.5 ft	690.5	1366.5	1179.1	187.4	488.6	38.4%
B21-1706	LDW21-GT18-GB-26.5-28 ft	359.5	929.9	801.2	128.7	441.7	29.1%

All results apply only to actual locations and materials tested. As a mutual protection to clients, the public and ourselves, all reports are submitted as the confidential property of clients, and authorization for publication of statements, conclusions or extracts from or regarding our reports is reserved pending our written approval.

Reviewed by:   
 Meghan Blodgett-Carrillo



### Moisture Content - ASTM D854

**Project:** Q.C. - Lower Duwamish Waterway

**Client:** Anchor QEA

**Project #:** 21B233

**Date Received:** July 29, 2021


**Sampled by:** Client

**Date Tested:** September 13, 2021

**Tested by:** A. Eifrig

Sample #	Location	Tare	Dry Soil + Tare	Mass of Dry Soil	Pycno ID	Mass of Pycno	Volume of Pycno	Density of Water @ Tx	Mass of Pycno filled w/ water & soils	Mass of Pycno filled w/ water	Temp. of Water, 0.1 *C	SpG of Soils	Temp. Correction Factor	Corrected SpG
B21-1695	LDW21-GT37-GB-10-20 ft	493.21	568.13	74.9	TSA-013	184.0	499.7	0.99756	728.81	682.44	22.9	2.6240964	0.99936	2.6224169
B21-1697	LDW21-GT37-GB-20-30 ft	497.94	575.45	77.5	TSA-011	190.3	499.5	0.99752	736.61	688.63	23.1	2.624687	0.99931	2.6228759
B21-1700	LDW21-GT18-GB-0-6.5 ft	600.24	700.15	99.9	TSA-020	195.0	499.5	0.99752	753.52	693.28	23.1	2.5184539	0.99931	2.5167161
B21-1702	LDW21-GT18-GB-6.5-16.5 ft	510.32	612.20	101.9	TSA-010	180.3	499.5	0.99754	742.28	678.62	23.0	2.6655395	0.99933	2.6637535
B21-1705	LDW21-GT18-GB-21.4-26.5 ft	501.27	576.59	75.3	TSA-021	183.4	499.4	0.99745	727.11	681.56	23.4	2.5303609	0.99924	2.5284379

All results apply only to actual locations and materials tested. As a mutual protection to clients, the public and ourselves, all reports are submitted as the confidential property of clients, and authorization for publication of statements, conclusions or extracts from or regarding our reports is reserved pending our written approval.

Reviewed by:   
 Meghan Blodgett-Carrillo



## Sieve Report

<b>Project:</b> Q.C. - Lower Duwamish Waterway <b>Project #:</b> 21B233 <b>Client:</b> Anchor QEA <b>Source:</b> LDW21-GT37-GB-10-20 ft <b>Sample#:</b> B21-1695	<b>Date Received:</b> 29-Jul-21 <b>Sampled By:</b> Client <b>Date Tested:</b> 13-Sep-21 <b>Tested By:</b> C. Kriss	<b>Unified Soil Classification System, ASTM-2487</b> SM, Silty Sand <b>Sample Color:</b> brown	 <b>ACCREDITED</b> Certificate #: 1366.01
--	---	---	---

**ASTM D2216, ASTM D2419, ASTM D4318, ASTM D5281**

**Specifications**

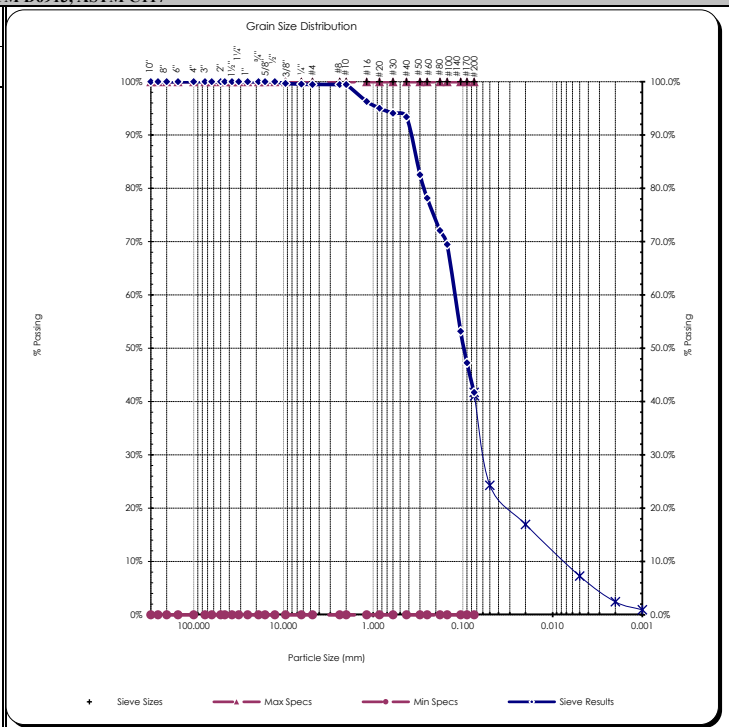
No Specs

Sample Meets Specs ? **N/A**

D <sub>(5)</sub> = 0.003 mm	% Gravel = 0.5%	Coeff. of Curvature, C <sub>c</sub> = 3.61
D <sub>(10)</sub> = 0.007 mm	% Sand = 57.8%	Coeff. of Uniformity, C <sub>u</sub> = 17.03
D <sub>(15)</sub> = 0.016 mm	% Silt & Clay = 41.7%	Fineness Modulus = 0.59
D <sub>(30)</sub> = 0.057 mm	Liquid Limit = 0.0%	Plastic Limit = 0.0%
D <sub>(50)</sub> = 0.097 mm	Plasticity Index = 0.0%	Moisture %, as sampled = 48.3%
D <sub>(60)</sub> = 0.124 mm	Sand Equivalent = n/a	Req'd Sand Equivalent =
D <sub>(90)</sub> = 0.386 mm	Fracture %, 1 Face = n/a	Req'd Fracture %, 1 Face =
Dust Ratio = 21/47	Fracture %, 2+ Faces = n/a	Req'd Fracture %, 2+ Faces =

**ASTM C136, ASTM D6913, ASTM C117**

Sieve Size		Actual Cumulative Percent Passing	Interpolated Cumulative Percent Passing	Specs Max	Specs Min
US	Metric				
12.00"	300.00		100%	100.0%	0.0%
10.00"	250.00		100%	100.0%	0.0%
8.00"	200.00		100%	100.0%	0.0%
6.00"	150.00		100%	100.0%	0.0%
4.00"	100.00		100%	100.0%	0.0%
3.00"	75.00		100%	100.0%	0.0%
2.50"	63.00		100%	100.0%	0.0%
2.00"	50.00	100%	100%	100.0%	0.0%
1.75"	45.00	100%	100%	100.0%	0.0%
1.50"	37.50	100%	100%	100.0%	0.0%
1.25"	31.50	100%	100%	100.0%	0.0%
1.00"	25.00	100%	100%	100.0%	0.0%
3/4"	19.00	100%	100%	100.0%	0.0%
5/8"	16.00	100%	100%	100.0%	0.0%
1/2"	12.50	100%	100%	100.0%	0.0%
3/8"	9.50	100%	100%	100.0%	0.0%
1/4"	6.30	100%	100%	100.0%	0.0%
#4	4.75	99%	99%	100.0%	0.0%
#8	2.36	99%	99%	100.0%	0.0%
#10	2.00	99%	99%	100.0%	0.0%
#16	1.18	96%	96%	100.0%	0.0%
#20	0.850	95%	95%	100.0%	0.0%
#30	0.600	94%	94%	100.0%	0.0%
#40	0.425	93%	93%	100.0%	0.0%
#50	0.300	83%	83%	100.0%	0.0%
#60	0.250	78%	78%	100.0%	0.0%
#80	0.180	72%	72%	100.0%	0.0%
#100	0.150	69%	69%	100.0%	0.0%
#140	0.106	53%	53%	100.0%	0.0%
#170	0.090	47%	47%	100.0%	0.0%
#200	0.075	41.7%	41.7%	100.0%	0.0%




Copyright Spears Engineering & Technical Services PS, 1996-98  
 All results apply only to actual locations and materials tested. As a mutual protection to clients, the public and ourselves, all reports are submitted as the confidential property of clients, and authorization for publication of statements, conclusions or extracts from or regarding our reports is reserved pending our written approval.

**Comments:** \_\_\_\_\_

Reviewed by:   
 Meghan Blodgett-Carrillo

## Hydrometer Report

<b>Project:</b> Q.C. - Lower Duwamish Waterway <b>Project #:</b> 21B233 <b>Client:</b> Anchor QEA <b>Source:</b> LDW21-GT37-GB-10-20 ft <b>Sample#:</b> B21-1695	<b>Date Received:</b> 29-Jul-21 <b>Sampled By:</b> Client <b>Date Tested:</b> 13-Sep-21 <b>Tested By:</b> C. Kriss	<b>Unified Soil Classification System, ASTM-2487</b> SM, Silty Sand <b>Sample Color</b> brown																																																																					
<b>ASTM D7928, HYDROMETER ANALYSIS</b>		<b>ASTM D6913</b>																																																																					
<b>Sp Gr :</b> 2.62 <b>Sample Weight:</b> 74.76 grams <b>Hydroscopic Moist.:</b> 2.84% <b>Adj. Sample Wgt :</b> 72.70 grams		<b>Sieve Analysis</b> <b>Grain Size Distribution</b>																																																																					
		<table border="1" style="width: 100%; border-collapse: collapse;"> <thead> <tr> <th>Sieve Size</th> <th>Percent Passing</th> <th>Soils Particle Diameter</th> </tr> </thead> <tbody> <tr><td>3.0"</td><td>100%</td><td>75.000 mm</td></tr> <tr><td>2.0"</td><td>100%</td><td>50.000 mm</td></tr> <tr><td>1.5"</td><td>100%</td><td>37.500 mm</td></tr> <tr><td>1.25"</td><td>100%</td><td>31.500 mm</td></tr> <tr><td>1.0"</td><td>100%</td><td>25.000 mm</td></tr> <tr><td>3/4"</td><td>100%</td><td>19.000 mm</td></tr> <tr><td>5/8"</td><td>100%</td><td>16.000 mm</td></tr> <tr><td>1/2"</td><td>100%</td><td>12.500 mm</td></tr> <tr><td>3/8"</td><td>100%</td><td>9.500 mm</td></tr> <tr><td>1/4"</td><td>100%</td><td>6.300 mm</td></tr> <tr><td>#4</td><td>99%</td><td>4.750 mm</td></tr> <tr><td>#10</td><td>99%</td><td>2.000 mm</td></tr> <tr><td>#20</td><td>95%</td><td>0.850 mm</td></tr> <tr><td>#40</td><td>93%</td><td>0.425 mm</td></tr> <tr><td>#100</td><td>69%</td><td>0.150 mm</td></tr> <tr><td>#200</td><td>41.7%</td><td>0.075 mm</td></tr> <tr><td><b>Silts</b></td><td>41.1%</td><td>0.074 mm</td></tr> <tr><td></td><td>24.3%</td><td>0.050 mm</td></tr> <tr><td></td><td>17.0%</td><td>0.020 mm</td></tr> <tr><td><b>Clays</b></td><td>7.3%</td><td>0.005 mm</td></tr> <tr><td></td><td>2.5%</td><td>0.002 mm</td></tr> <tr><td><b>Colloids</b></td><td>0.9%</td><td>0.001 mm</td></tr> </tbody> </table>	Sieve Size	Percent Passing	Soils Particle Diameter	3.0"	100%	75.000 mm	2.0"	100%	50.000 mm	1.5"	100%	37.500 mm	1.25"	100%	31.500 mm	1.0"	100%	25.000 mm	3/4"	100%	19.000 mm	5/8"	100%	16.000 mm	1/2"	100%	12.500 mm	3/8"	100%	9.500 mm	1/4"	100%	6.300 mm	#4	99%	4.750 mm	#10	99%	2.000 mm	#20	95%	0.850 mm	#40	93%	0.425 mm	#100	69%	0.150 mm	#200	41.7%	0.075 mm	<b>Silts</b>	41.1%	0.074 mm		24.3%	0.050 mm		17.0%	0.020 mm	<b>Clays</b>	7.3%	0.005 mm		2.5%	0.002 mm	<b>Colloids</b>	0.9%	0.001 mm
Sieve Size	Percent Passing	Soils Particle Diameter																																																																					
3.0"	100%	75.000 mm																																																																					
2.0"	100%	50.000 mm																																																																					
1.5"	100%	37.500 mm																																																																					
1.25"	100%	31.500 mm																																																																					
1.0"	100%	25.000 mm																																																																					
3/4"	100%	19.000 mm																																																																					
5/8"	100%	16.000 mm																																																																					
1/2"	100%	12.500 mm																																																																					
3/8"	100%	9.500 mm																																																																					
1/4"	100%	6.300 mm																																																																					
#4	99%	4.750 mm																																																																					
#10	99%	2.000 mm																																																																					
#20	95%	0.850 mm																																																																					
#40	93%	0.425 mm																																																																					
#100	69%	0.150 mm																																																																					
#200	41.7%	0.075 mm																																																																					
<b>Silts</b>	41.1%	0.074 mm																																																																					
	24.3%	0.050 mm																																																																					
	17.0%	0.020 mm																																																																					
<b>Clays</b>	7.3%	0.005 mm																																																																					
	2.5%	0.002 mm																																																																					
<b>Colloids</b>	0.9%	0.001 mm																																																																					
<table border="1" style="width: 100%; border-collapse: collapse;"> <thead> <tr> <th>Hydrometer Reading Minutes</th> <th>Corrected Reading</th> <th>Percent Passing</th> <th>Soils Particle Diameter</th> </tr> </thead> <tbody> <tr><td>1</td><td>18.5</td><td>25.6%</td><td>0.0505 mm</td></tr> <tr><td>2</td><td>15.5</td><td>21.4%</td><td>0.0364 mm</td></tr> <tr><td>5</td><td>13.5</td><td>18.7%</td><td>0.0234 mm</td></tr> <tr><td>15</td><td>10</td><td>13.8%</td><td>0.0137 mm</td></tr> <tr><td>30</td><td>9</td><td>12.4%</td><td>0.0097 mm</td></tr> <tr><td>60</td><td>7</td><td>9.7%</td><td>0.0070 mm</td></tr> <tr><td>240</td><td>4</td><td>5.5%</td><td>0.0035 mm</td></tr> <tr><td>1440</td><td>1</td><td>1.4%</td><td>0.0015 mm</td></tr> </tbody> </table>		Hydrometer Reading Minutes	Corrected Reading	Percent Passing	Soils Particle Diameter	1	18.5	25.6%	0.0505 mm	2	15.5	21.4%	0.0364 mm	5	13.5	18.7%	0.0234 mm	15	10	13.8%	0.0137 mm	30	9	12.4%	0.0097 mm	60	7	9.7%	0.0070 mm	240	4	5.5%	0.0035 mm	1440	1	1.4%	0.0015 mm																																		
Hydrometer Reading Minutes	Corrected Reading	Percent Passing	Soils Particle Diameter																																																																				
1	18.5	25.6%	0.0505 mm																																																																				
2	15.5	21.4%	0.0364 mm																																																																				
5	13.5	18.7%	0.0234 mm																																																																				
15	10	13.8%	0.0137 mm																																																																				
30	9	12.4%	0.0097 mm																																																																				
60	7	9.7%	0.0070 mm																																																																				
240	4	5.5%	0.0035 mm																																																																				
1440	1	1.4%	0.0015 mm																																																																				
<b>% Gravel:</b> 0.5% <b>Liquid Limit:</b> 0.0 % <b>% Sand:</b> 57.8% <b>Plastic Limit:</b> 0.0 % <b>% Silt:</b> 34.4% <b>Plasticity Index:</b> 0.0 % <b>% Clay:</b> 7.3%																																																																							
<b>USDA Soil Textural Classification</b>																																																																							
<table border="1" style="width: 100%; border-collapse: collapse;"> <thead> <tr> <th></th> <th>Particle Size</th> </tr> </thead> <tbody> <tr><td><b>% Sand:</b></td><td>2.0 - 0.05 mm</td></tr> <tr><td><b>% Silt:</b></td><td>0.05 - 0.002 mm</td></tr> <tr><td><b>% Clay:</b></td><td>&lt; 0.002 mm</td></tr> </tbody> </table>			Particle Size	<b>% Sand:</b>	2.0 - 0.05 mm	<b>% Silt:</b>	0.05 - 0.002 mm	<b>% Clay:</b>	< 0.002 mm																																																														
	Particle Size																																																																						
<b>% Sand:</b>	2.0 - 0.05 mm																																																																						
<b>% Silt:</b>	0.05 - 0.002 mm																																																																						
<b>% Clay:</b>	< 0.002 mm																																																																						
<b>USDA Soil Textural Classification</b>																																																																							
Loamy Sand																																																																							

All results apply only to actual locations and materials tested. As a mutual protection to clients, the public and ourselves, all reports are submitted as the confidential property of clients, and authorization for publication of statements, conclusions or extracts from or regarding our reports is reserved pending our written approval.

**Comments:** \_\_\_\_\_

\_\_\_\_\_

\_\_\_\_\_

**Reviewed by:**  \_\_\_\_\_  
 Meghan Blodgett-Carrillo

# Direct Shear Test Results:

ASTM D-3080



Project: Q.C. - Lower Duwamish Waterway  
 Project Number: 21B233  
 Laboratory Sample ID: B21-1695  
 Sample Date: 7/14/2021  
 Test Date: 9/16/2021  
 Technician: M. Carrillo

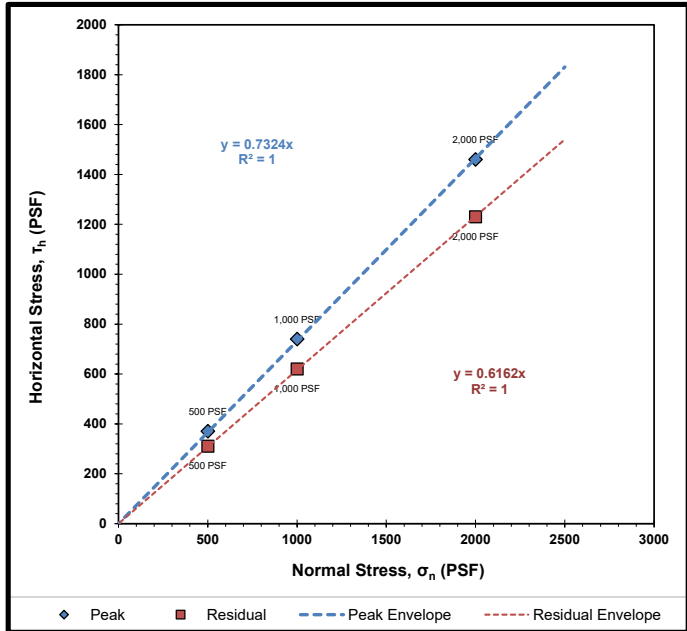
Sample Source: LDW21-GT37-GB-10-20 ft  
 Visual Soil Description: brown silty sand  
 Type of Specimen: Remolded Cylindrical Shear Box  
 Specimen Diameter (in): 2.5  
 Specimen Height (in): 1  
 Rate of Strain (in/min): 0.0208  
 Estimated Specific Gravity of Solids: 2.65

Summary of Sample Data: $\sigma_n=500$ PSF		
Initial Moisture Content (%)	35.3	
	Initial	Post-Consolidation
Dry Density (PCF):	100.7	102.8
Void Ratio:	0.673	0.639
Porosity (%):	40.2	39.0
Degree of Saturation (%):	saturated	saturated

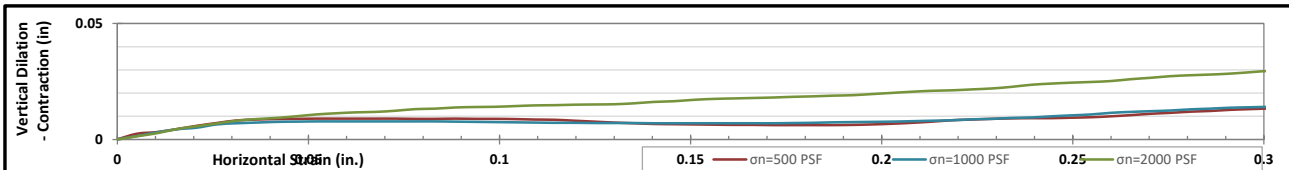
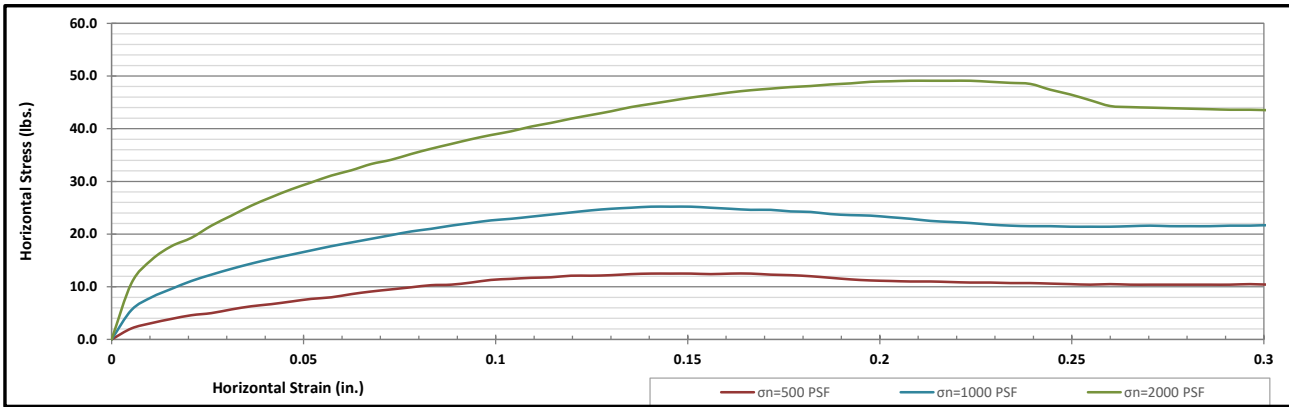
Summary of Sample Data: $\sigma_n=1000$ PSF		
Initial Moisture Content (%)	36.0	
	Initial	Post-Consolidation
Dry Density (PCF):	100.9	110.5
Void Ratio:	0.670	0.525
Porosity (%):	40.1	34.4
Degree of Saturation (%):	saturated	saturated

Summary of Sample Data: $\sigma_n=2000$ PSF		
Initial Moisture Content (%)	35.4	
	Initial	Post-Consolidation
Dry Density (PCF):	101.4	114.5
Void Ratio:	0.662	0.471
Porosity (%):	39.8	32.0
Degree of Saturation (%):	saturated	saturated

ESTIMATED STRENGTH PARAMETERS		
	PEAK	RESIDUAL
Angle of Internal Friction, $\phi$ (°):	36	32
Cohesion (PSF):	0	0



Failure Envelope Test Values:			
Normal Stress, $\sigma_n$ (PSF):	500	1000	2000
Peak Horizontal Stress, $\tau_h$ (PSF):	370	740	1460
Residual Horizontal Stress, $\tau_h$ (PSF):	310	620	1230



Corporate • 777 Chrysler Drive • Burlington, WA 98233 • Phone 360.755.1990 • Fax 360.755.1980  
 SW Region • 2118 Black Lake Blvd. S.W. • Olympia, WA 98512 • Phone 360.534.9777 • Fax 360.534.9779  
 NW Region • 805 Dupont, Suite #5 • Bellingham, WA 98225 • Phone 360.647.6061 • Fax 360.647.8111  
 Kitsap Region • 5451 N.W. Newberry Hill Road, Suite 101 • Silverdale, WA 98383 • Phone/Fax 360.698.6787

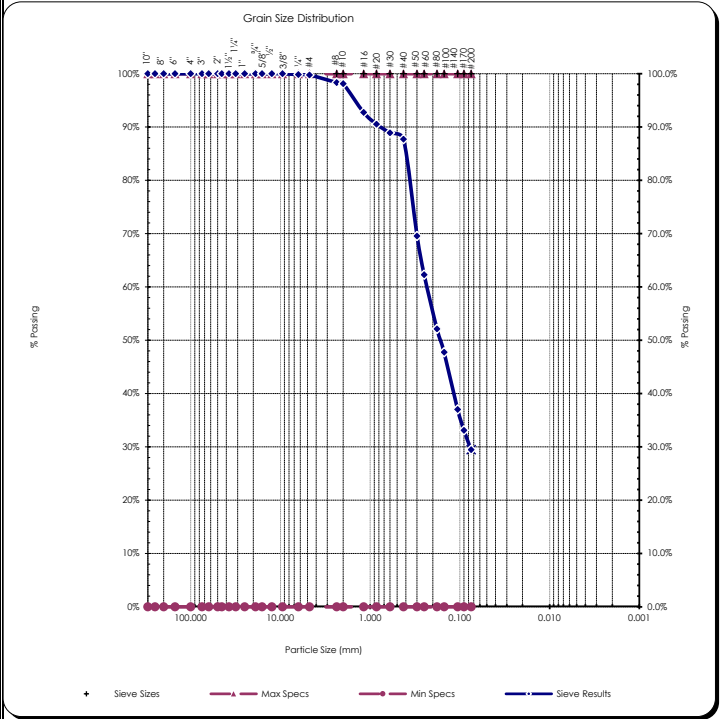
Visit our website: [www.mtc-inc.net](http://www.mtc-inc.net)

# Sieve Report

<b>Project:</b> Q.C. - Lower Duwamish Waterway <b>Project #:</b> 21B233 <b>Client:</b> Anchor QEA <b>Source:</b> LDW21-GT37-GB-20-30 ft <b>Sample#:</b> B21-1697	<b>Date Received:</b> 29-Jul-21 <b>Sampled By:</b> Client <b>Date Tested:</b> 13-Sep-21 <b>Tested By:</b> C. Kriss	<b>Unified Soil Classification System, ASTM-2487</b> SM, Silty Sand <b>Sample Color:</b> brown	 <b>ACCREDITED</b> Certificate #: 1366.01
--	---	---	---

<b>ASTM D2216, ASTM D2419, ASTM D4318, ASTM D5281</b>			
<b>Specifications</b> No Specs <b>Sample Meets Specs ? N/A</b>	$D_{(5)} = 0.013$ mm $D_{(10)} = 0.025$ mm $D_{(15)} = 0.038$ mm $D_{(30)} = 0.077$ mm $D_{(50)} = 0.165$ mm $D_{(60)} = 0.234$ mm $D_{(90)} = 0.767$ mm Dust Ratio = 1/3	% Gravel = 0.2% % Sand = 70.3% % Silt & Clay = 29.5% Liquid Limit = 0.0% Plasticity Index = 0.0% Sand Equivalent = n/a Fracture %, 1 Face = n/a Fracture %, 2+ Faces = n/a	Coeff. of Curvature, $C_c = 1.00$ Coeff. of Uniformity, $C_u = 9.20$ Fineness Modulus = 1.03 Plastic Limit = 0.0% Moisture %, as sampled = 39.7% Req'd Sand Equivalent = Req'd Fracture %, 1 Face = Req'd Fracture %, 2+ Faces =

<b>ASTM C136, ASTM D6913, ASTM C117</b>					
Sieve Size		Actual Cumulative Percent Passing	Interpolated Cumulative Percent Passing	Specs Max	Specs Min
US	Metric				
12.00"	300.00		100%	100.0%	0.0%
10.00"	250.00		100%	100.0%	0.0%
8.00"	200.00		100%	100.0%	0.0%
6.00"	150.00		100%	100.0%	0.0%
4.00"	100.00		100%	100.0%	0.0%
3.00"	75.00		100%	100.0%	0.0%
2.50"	63.00		100%	100.0%	0.0%
2.00"	50.00	100%	100%	100.0%	0.0%
1.75"	45.00	100%	100%	100.0%	0.0%
1.50"	37.50	100%	100%	100.0%	0.0%
1.25"	31.50	100%	100%	100.0%	0.0%
1.00"	25.00	100%	100%	100.0%	0.0%
3/4"	19.00	100%	100%	100.0%	0.0%
5/8"	16.00	100%	100%	100.0%	0.0%
1/2"	12.50	100%	100%	100.0%	0.0%
3/8"	9.50	100%	100%	100.0%	0.0%
1/4"	6.30	100%	100%	100.0%	0.0%
#4	4.75	100%	100%	100.0%	0.0%
#8	2.36	98%	98%	100.0%	0.0%
#10	2.00	98%	98%	100.0%	0.0%
#16	1.18	93%	93%	100.0%	0.0%
#20	0.850	91%	91%	100.0%	0.0%
#30	0.600	89%	89%	100.0%	0.0%
#40	0.425	88%	88%	100.0%	0.0%
#50	0.300	70%	70%	100.0%	0.0%
#60	0.250	62%	62%	100.0%	0.0%
#80	0.180	52%	52%	100.0%	0.0%
#100	0.150	48%	48%	100.0%	0.0%
#140	0.106	37%	37%	100.0%	0.0%
#170	0.090	33%	33%	100.0%	0.0%
#200	0.075	29.5%	29.5%	100.0%	0.0%



Copyright Spears Engineering & Technical Services PS, 1996-98  
 All results apply only to actual locations and materials tested. As a mutual protection to clients, the public and ourselves, all reports are submitted as the confidential property of clients, and authorization for publication of statements, conclusions or extracts from or regarding our reports is reserved pending our written approval.

**Comments:** \_\_\_\_\_

Reviewed by:   
 Meghan Blodgett-Carrillo

## ASTM D4318 - Liquid Limit, Plastic Limit and Plasticity Index of Soils

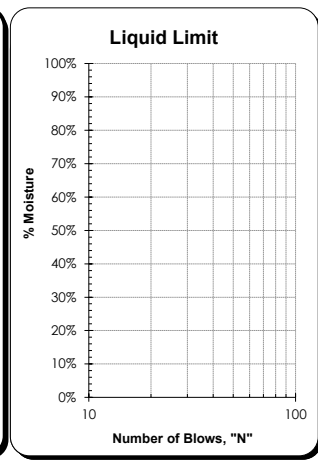
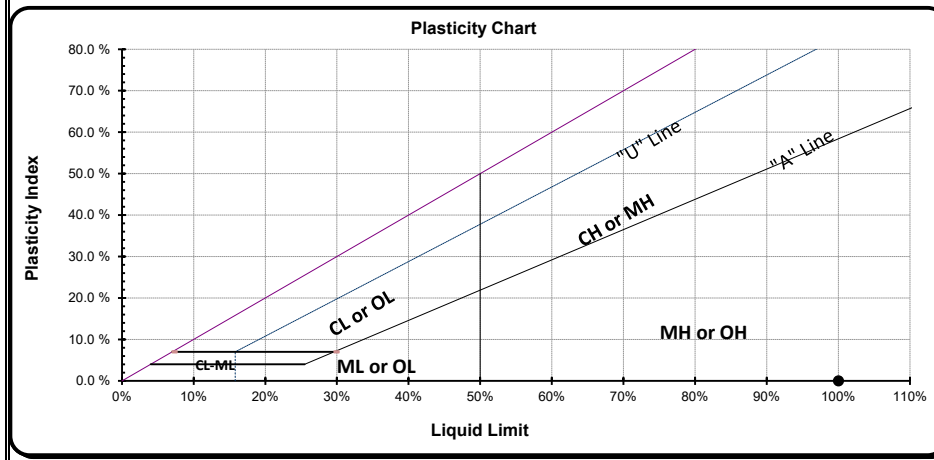
<b>Project:</b> Q.C. - Lower Duwamish Waterway <b>Project #:</b> 21B233 <b>Client:</b> Anchor QEA <b>Source:</b> LDW21-GT37-GB-20-30 ft <b>Sample #:</b> B21-1697	<b>Date Received:</b> 29-Jul-21 <b>Sampled By:</b> Client <b>Date Tested:</b> 13-Sep-21 <b>Tested By:</b> C. Kriss	<b>Unified Soils Classification System, ASTM D-2487</b> SM, Silty Sand <b>Sample Color</b> brown
---	---	---

Liquid Limit Determination						
	#1	#2	#3	#4	#5	#6
Weight of Wet Soils + Pan:	Liquid limit cannot be established					
Weight of Dry Soils + Pan:						
Weight of Pan:						
Weight of Dry Soils:						
Weight of Moisture:						
% Moisture:						
Number of Blows:						



**Liquid Limit @ 25 Blows:** N/A  
**Plastic Limit:** N/A  
**Plasticity Index, I<sub>p</sub>:** N/A

Plastic Limit Determination						
	#1	#2	#3	#4	#5	#6
Weight of Wet Soils + Pan:	Plastic limit cannot be determined					
Weight of Dry Soils + Pan:						
Weight of Pan:						
Weight of Dry Soils:						
Weight of Moisture:						
% Moisture:						



Copyright Spears Engineering & Technical Services PS, 1996-98

All results apply only to actual locations and materials tested. As a mutual protection to clients, the public and ourselves, all reports are submitted as the confidential property of clients, and authorization for publication of statements, conclusions or extracts from or regarding our reports is reserved pending our written approval.

**Comments:** Liquid limit cannot be established as the material displays rapid dilation upon spreading into the cup. At lower moistures the material does not spread into the liquid limit cup without tearing the soil cake. Plastic limit cannot be determined as the material does not roll down to 1/8" threads before cracking or crumbling. Non-plastic.

Reviewed by: \_\_\_\_\_  
 Meghan Blodgett-Carrillo

## ASTM D4318 - Liquid Limit, Plastic Limit and Plasticity Index of Soils

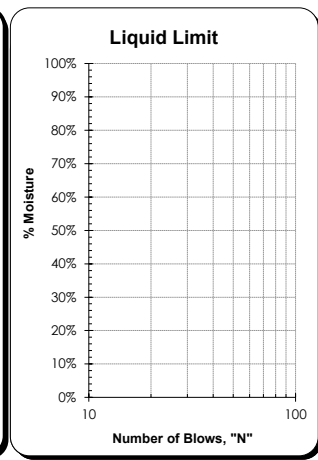
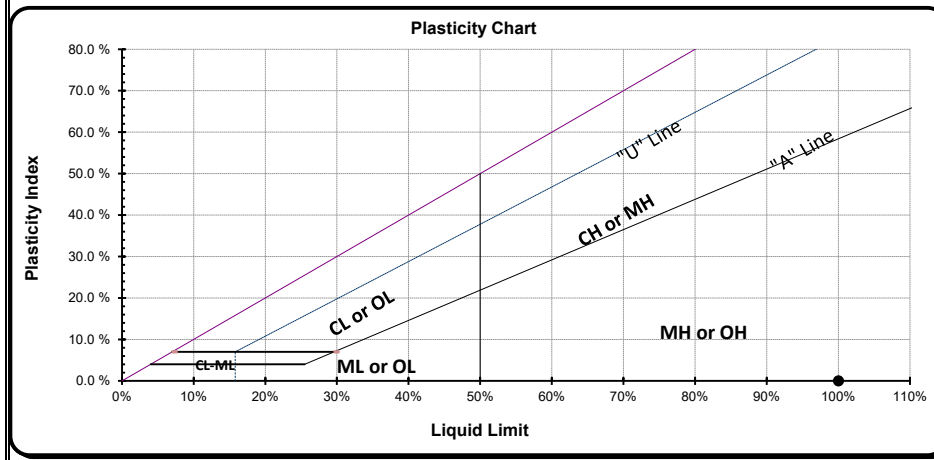
<b>Project:</b> Q.C. - Lower Duwamish Waterway <b>Project #:</b> 21B233 <b>Client:</b> Anchor QEA <b>Source:</b> LDW21-GT18-GB-0-6.5 ft <b>Sample #:</b> B21-1700	<b>Date Received:</b> 29-Jul-21 <b>Sampled By:</b> Client <b>Date Tested:</b> 13-Sep-21 <b>Tested By:</b> C. Kriss	<b>Visual Identification</b> Sand with Silt <b>Sample Color</b> brown
---	---	--

Liquid Limit Determination						
	#1	#2	#3	#4	#5	#6
Weight of Wet Soils + Pan:	Liquid limit cannot be established					
Weight of Dry Soils + Pan:						
Weight of Pan:						
Weight of Dry Soils:						
Weight of Moisture:						
% Moisture:						
Number of Blows:						



**Liquid Limit @ 25 Blows:** N/A  
**Plastic Limit:** N/A  
**Plasticity Index, I<sub>p</sub>:** N/A

Plastic Limit Determination						
	#1	#2	#3	#4	#5	#6
Weight of Wet Soils + Pan:	Plastic limit cannot be determined					
Weight of Dry Soils + Pan:						
Weight of Pan:						
Weight of Dry Soils:						
Weight of Moisture:						
% Moisture:						




Copyright Spears Engineering & Technical Services PS, 1996-98  
 All results apply only to actual locations and materials tested. As a mutual protection to clients, the public and ourselves, all reports are submitted as the confidential property of clients, and authorization for publication of statements, conclusions or extracts from or regarding our reports is reserved pending our written approval.

**Comments:** Liquid limit cannot be established as the material displays rapid dilation upon spreading into the cup. At lower moistures the material does not spread into the liquid limit cup without tearing the soil cake. Plastic limit cannot be determined as the material does not roll down to 1/8" threads before cracking or crumbling. Non-plastic.

Reviewed by:   
 \_\_\_\_\_  
 Meghan Blodgett-Carrillo

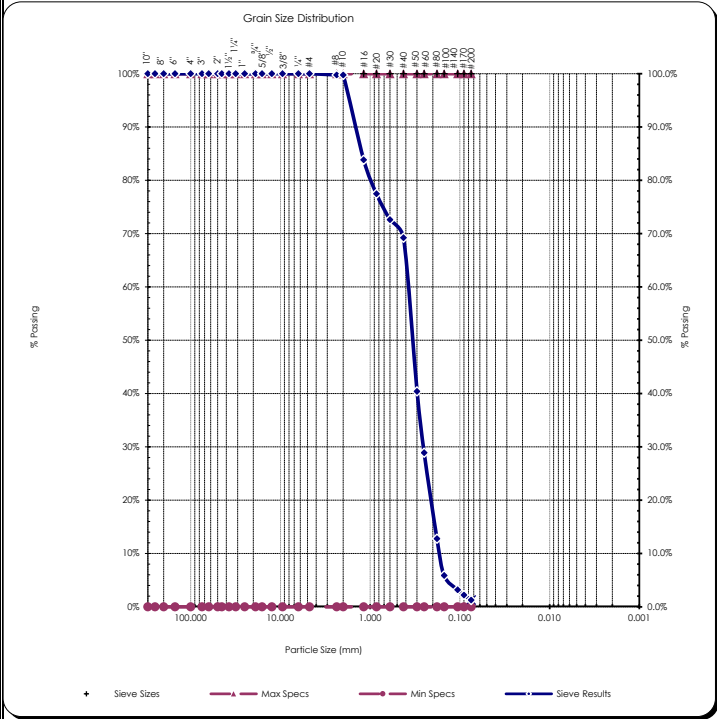


# Sieve Report

<b>Project:</b> Q.C. - Lower Duwamish Waterway <b>Project #:</b> 21B233 <b>Client:</b> Anchor QEA <b>Source:</b> LDW21-GT18-GB-6.5-16.5 ft <b>Sample#:</b> B21-1702	<b>Date Received:</b> 29-Jul-21 <b>Sampled By:</b> Client <b>Date Tested:</b> 13-Sep-21 <b>Tested By:</b> C. Kriss	<b>Unified Soil Classification System, ASTM-2487</b> SP, Poorly graded Sand <b>Sample Color:</b> brown	 Certificate #: 1366.01
---	---	---	---

<b>ASTM D2216, ASTM D2419, ASTM D4318, ASTM D5281</b>			
<b>Specifications</b> No Specs <b>Sample Meets Specs ?</b> N/A	D <sub>(5)</sub> = 0.136 mm D <sub>(10)</sub> = 0.168 mm D <sub>(15)</sub> = 0.190 mm D <sub>(30)</sub> = 0.255 mm D <sub>(50)</sub> = 0.342 mm D <sub>(60)</sub> = 0.385 mm D <sub>(90)</sub> = 1.497 mm Dust Ratio = 1/54	% Gravel = 0.0% % Sand = 98.7% % Silt & Clay = 1.3% Liquid Limit = n/a Plasticity Index = n/a Sand Equivalent = n/a Fracture %, 1 Face = n/a Fracture %, 2+ Faces = n/a	Coeff. of Curvature, C <sub>c</sub> = 1.00 Coeff. of Uniformity, C <sub>u</sub> = 2.29 Fineness Modulus = 1.97 Plastic Limit = n/a Moisture %, as sampled = 23.6% Req'd Sand Equivalent = Req'd Fracture %, 1 Face = Req'd Fracture %, 2+ Faces =

<b>ASTM C136, ASTM D6913, ASTM C117</b>					
Sieve Size		Actual Cumulative Percent Passing	Interpolated Cumulative Percent Passing	Specs Max	Specs Min
US	Metric				
12.00"	300.00		100%	100.0%	0.0%
10.00"	250.00		100%	100.0%	0.0%
8.00"	200.00		100%	100.0%	0.0%
6.00"	150.00		100%	100.0%	0.0%
4.00"	100.00		100%	100.0%	0.0%
3.00"	75.00		100%	100.0%	0.0%
2.50"	63.00		100%	100.0%	0.0%
2.00"	50.00	100%	100%	100.0%	0.0%
1.75"	45.00	100%	100%	100.0%	0.0%
1.50"	37.50	100%	100%	100.0%	0.0%
1.25"	31.50	100%	100%	100.0%	0.0%
1.00"	25.00	100%	100%	100.0%	0.0%
3/4"	19.00	100%	100%	100.0%	0.0%
5/8"	16.00	100%	100%	100.0%	0.0%
1/2"	12.50	100%	100%	100.0%	0.0%
3/8"	9.50	100%	100%	100.0%	0.0%
1/4"	6.30	100%	100%	100.0%	0.0%
#4	4.75	100%	100%	100.0%	0.0%
#8	2.36	100%	100%	100.0%	0.0%
#10	2.00	100%	100%	100.0%	0.0%
#16	1.18		84%	100.0%	0.0%
#20	0.850		77%	100.0%	0.0%
#30	0.600		73%	100.0%	0.0%
#40	0.425	69%	69%	100.0%	0.0%
#50	0.300		40%	100.0%	0.0%
#60	0.250		29%	100.0%	0.0%
#80	0.180		13%	100.0%	0.0%
#100	0.150	6%	6%	100.0%	0.0%
#140	0.106		3%	100.0%	0.0%
#170	0.090		2%	100.0%	0.0%
#200	0.075	1.3%	1.3%	100.0%	0.0%



Copyright Spears Engineering & Technical Services PS, 1996-98  
 All results apply only to actual locations and materials tested. As a mutual protection to clients, the public and ourselves, all reports are submitted as the confidential property of clients, and authorization for publication of statements, conclusions or extracts from or regarding our reports is reserved pending our written approval.

**Comments:** \_\_\_\_\_

Reviewed by:   
 Meghan Blodgett-Carrillo

# Sieve Report

<b>Project:</b> Q.C. - Lower Duwamish Waterway <b>Project #:</b> 21B233 <b>Client:</b> Anchor QEA <b>Source:</b> LDW21-GT18-GB-16.5-21.4 ft <b>Sample#:</b> B21-1704	<b>Date Received:</b> 29-Jul-21 <b>Sampled By:</b> Client <b>Date Tested:</b> 13-Sep-21 <b>Tested By:</b> C. Kriss	<b>Unified Soil Classification System, ASTM-2487</b> SM, Silty Sand <b>Sample Color:</b> brown	 <b>ACCREDITED</b> Certificate #: 1366.01
--	---	---	---

<b>ASTM D2216, ASTM D2419, ASTM D4318, ASTM D5281</b>			
<b>Specifications</b> No Specs <b>Sample Meets Specs ? N/A</b>	$D_{(5)} = 0.005$ mm $D_{(10)} = 0.014$ mm $D_{(15)} = 0.038$ mm $D_{(30)} = 0.081$ mm $D_{(50)} = 0.122$ mm $D_{(60)} = 0.142$ mm $D_{(90)} = 0.351$ mm Dust Ratio = 3/11	% Gravel = 0.0% % Sand = 72.8% % Silt & Clay = 27.2% Liquid Limit = 0.0% Plasticity Index = 0.0% Sand Equivalent = n/a Fracture %, 1 Face = n/a Fracture %, 2+ Faces = n/a	Coeff. of Curvature, $C_c = 3.31$ Coeff. of Uniformity, $C_u = 10.24$ Fineness Modulus = 0.53 Plastic Limit = 0.0% Moisture %, as sampled = 37.6% Req'd Sand Equivalent = Req'd Fracture %, 1 Face = Req'd Fracture %, 2+ Faces =

<b>ASTM C136, ASTM D6913, ASTM C117</b>					
<b>Sieve Size</b>		<b>Actual Cumulative Percent Passing</b>	<b>Interpolated Cumulative Percent Passing</b>	<b>Specs Max</b>	<b>Specs Min</b>
US	Metric				
12.00"	300.00		100%	100.0%	0.0%
10.00"	250.00		100%	100.0%	0.0%
8.00"	200.00		100%	100.0%	0.0%
6.00"	150.00		100%	100.0%	0.0%
4.00"	100.00		100%	100.0%	0.0%
3.00"	75.00		100%	100.0%	0.0%
2.50"	63.00		100%	100.0%	0.0%
2.00"	50.00	100%	100%	100.0%	0.0%
1.75"	45.00	100%	100%	100.0%	0.0%
1.50"	37.50	100%	100%	100.0%	0.0%
1.25"	31.50	100%	100%	100.0%	0.0%
1.00"	25.00	100%	100%	100.0%	0.0%
3/4"	19.00	100%	100%	100.0%	0.0%
5/8"	16.00	100%	100%	100.0%	0.0%
1/2"	12.50	100%	100%	100.0%	0.0%
3/8"	9.50	100%	100%	100.0%	0.0%
1/4"	6.30	100%	100%	100.0%	0.0%
#4	4.75	100%	100%	100.0%	0.0%
#8	2.36	100%	100%	100.0%	0.0%
#10	2.00	100%	100%	100.0%	0.0%
#16	1.18	100%	100%	100.0%	0.0%
#20	0.850	100%	100%	100.0%	0.0%
#30	0.600	100%	100%	100.0%	0.0%
#40	0.425	100%	100%	100.0%	0.0%
#50	0.300	83%	83%	100.0%	0.0%
#60	0.250	77%	77%	100.0%	0.0%
#80	0.180	68%	68%	100.0%	0.0%
#100	0.150	64%	64%	100.0%	0.0%
#140	0.106	42%	42%	100.0%	0.0%
#170	0.090	35%	35%	100.0%	0.0%
#200	0.075	27.2%	27.2%	100.0%	0.0%

Grain Size Distribution

+ Sieve Sizes    — Max Specs    — Min Specs    — Sieve Results

Copyright Spears Engineering & Technical Services PS, 1996-98  
 All results apply only to actual locations and materials tested. As a mutual protection to clients, the public and ourselves, all reports are submitted as the confidential property of clients, and authorization for publication of statements, conclusions or extracts from or regarding our reports is reserved pending our written approval.


**Comments:** \_\_\_\_\_

Reviewed by:   
 Meghan Blodgett-Carrillo





# Hydrometer Report

<b>Project:</b> Q.C. - Lower Duwamish Waterway <b>Project #:</b> 21B233 <b>Client:</b> Anchor QEA <b>Source:</b> LDW21-GT18-GB-16.5-21.4 ft <b>Sample#:</b> B21-1704		<b>Date Received:</b> 29-Jul-21 <b>Sampled By:</b> Client <b>Date Tested:</b> 1-Sep-21 <b>Tested By:</b> C. Kriss		<b>Unified Soil Classification System, ASTM-2487</b> SM, Silty Sand <b>Sample Color</b> brown																																																																																																								
<b>ASTM D7928, HYDROMETER ANALYSIS</b>				<b>ASTM D6913</b>																																																																																																								
<b>Sp Gr :</b> 2.53 <b>Sample Weight:</b> 99.41 grams <b>Hydroscopic Moist.:</b> 2.98% <b>Adj. Sample Wgt :</b> 96.53 grams		 ACCREDITED Certificate #: 1366.01		<b>Sieve Analysis</b> <b>Grain Size Distribution</b>																																																																																																								
<table border="1"> <thead> <tr> <th>Hydrometer Reading Minutes</th> <th>Corrected Reading</th> <th>Percent Passing</th> <th>Soils Particle Diameter</th> </tr> </thead> <tbody> <tr><td>1</td><td>17</td><td>18.1%</td><td>0.0526 mm</td></tr> <tr><td>2</td><td>14</td><td>14.9%</td><td>0.0379 mm</td></tr> <tr><td>5</td><td>12.5</td><td>13.3%</td><td>0.0242 mm</td></tr> <tr><td>15</td><td>9.5</td><td>10.1%</td><td>0.0142 mm</td></tr> <tr><td>30</td><td>8</td><td>8.5%</td><td>0.0101 mm</td></tr> <tr><td>60</td><td>6.5</td><td>6.9%</td><td>0.0072 mm</td></tr> <tr><td>240</td><td>4</td><td>4.3%</td><td>0.0036 mm</td></tr> <tr><td>1440</td><td>2</td><td>2.1%</td><td>0.0015 mm</td></tr> </tbody> </table>		Hydrometer Reading Minutes	Corrected Reading	Percent Passing	Soils Particle Diameter	1	17	18.1%	0.0526 mm	2	14	14.9%	0.0379 mm	5	12.5	13.3%	0.0242 mm	15	9.5	10.1%	0.0142 mm	30	8	8.5%	0.0101 mm	60	6.5	6.9%	0.0072 mm	240	4	4.3%	0.0036 mm	1440	2	2.1%	0.0015 mm	<table border="1"> <thead> <tr> <th>Sieve Size</th> <th>Percent Passing</th> <th>Soils Particle Diameter</th> </tr> </thead> <tbody> <tr><td>3.0"</td><td>100%</td><td>75.000 mm</td></tr> <tr><td>2.0"</td><td>100%</td><td>50.000 mm</td></tr> <tr><td>1.5"</td><td>100%</td><td>37.500 mm</td></tr> <tr><td>1.25"</td><td>100%</td><td>31.500 mm</td></tr> <tr><td>1.0"</td><td>100%</td><td>25.000 mm</td></tr> <tr><td>3/4"</td><td>100%</td><td>19.000 mm</td></tr> <tr><td>5/8"</td><td>100%</td><td>16.000 mm</td></tr> <tr><td>1/2"</td><td>100%</td><td>12.500 mm</td></tr> <tr><td>3/8"</td><td>100%</td><td>9.500 mm</td></tr> <tr><td>1/4"</td><td>100%</td><td>6.300 mm</td></tr> <tr><td>#4</td><td>100%</td><td>4.750 mm</td></tr> <tr><td>#10</td><td>100%</td><td>2.000 mm</td></tr> <tr><td>#20</td><td>100%</td><td>0.850 mm</td></tr> <tr><td>#40</td><td>100%</td><td>0.425 mm</td></tr> <tr><td>#100</td><td>64%</td><td>0.150 mm</td></tr> <tr><td>#200</td><td>27.2%</td><td>0.075 mm</td></tr> <tr><td><b>Silts</b></td><td>26.8%</td><td>0.074 mm</td></tr> <tr><td></td><td>16.4%</td><td>0.050 mm</td></tr> <tr><td></td><td>12.0%</td><td>0.020 mm</td></tr> <tr><td><b>Clays</b></td><td>5.3%</td><td>0.005 mm</td></tr> <tr><td></td><td>2.6%</td><td>0.002 mm</td></tr> <tr><td><b>Colloids</b></td><td>1.4%</td><td>0.001 mm</td></tr> </tbody> </table>		Sieve Size	Percent Passing	Soils Particle Diameter	3.0"	100%	75.000 mm	2.0"	100%	50.000 mm	1.5"	100%	37.500 mm	1.25"	100%	31.500 mm	1.0"	100%	25.000 mm	3/4"	100%	19.000 mm	5/8"	100%	16.000 mm	1/2"	100%	12.500 mm	3/8"	100%	9.500 mm	1/4"	100%	6.300 mm	#4	100%	4.750 mm	#10	100%	2.000 mm	#20	100%	0.850 mm	#40	100%	0.425 mm	#100	64%	0.150 mm	#200	27.2%	0.075 mm	<b>Silts</b>	26.8%	0.074 mm		16.4%	0.050 mm		12.0%	0.020 mm	<b>Clays</b>	5.3%	0.005 mm		2.6%	0.002 mm	<b>Colloids</b>	1.4%	0.001 mm
Hydrometer Reading Minutes	Corrected Reading	Percent Passing	Soils Particle Diameter																																																																																																									
1	17	18.1%	0.0526 mm																																																																																																									
2	14	14.9%	0.0379 mm																																																																																																									
5	12.5	13.3%	0.0242 mm																																																																																																									
15	9.5	10.1%	0.0142 mm																																																																																																									
30	8	8.5%	0.0101 mm																																																																																																									
60	6.5	6.9%	0.0072 mm																																																																																																									
240	4	4.3%	0.0036 mm																																																																																																									
1440	2	2.1%	0.0015 mm																																																																																																									
Sieve Size	Percent Passing	Soils Particle Diameter																																																																																																										
3.0"	100%	75.000 mm																																																																																																										
2.0"	100%	50.000 mm																																																																																																										
1.5"	100%	37.500 mm																																																																																																										
1.25"	100%	31.500 mm																																																																																																										
1.0"	100%	25.000 mm																																																																																																										
3/4"	100%	19.000 mm																																																																																																										
5/8"	100%	16.000 mm																																																																																																										
1/2"	100%	12.500 mm																																																																																																										
3/8"	100%	9.500 mm																																																																																																										
1/4"	100%	6.300 mm																																																																																																										
#4	100%	4.750 mm																																																																																																										
#10	100%	2.000 mm																																																																																																										
#20	100%	0.850 mm																																																																																																										
#40	100%	0.425 mm																																																																																																										
#100	64%	0.150 mm																																																																																																										
#200	27.2%	0.075 mm																																																																																																										
<b>Silts</b>	26.8%	0.074 mm																																																																																																										
	16.4%	0.050 mm																																																																																																										
	12.0%	0.020 mm																																																																																																										
<b>Clays</b>	5.3%	0.005 mm																																																																																																										
	2.6%	0.002 mm																																																																																																										
<b>Colloids</b>	1.4%	0.001 mm																																																																																																										
<b>USDA Soil Textural Classification</b>																																																																																																												
<table border="1"> <thead> <tr> <th></th> <th>Particle Size</th> </tr> </thead> <tbody> <tr><td>% Sand:</td><td>2.0 - 0.05 mm</td></tr> <tr><td>% Silt:</td><td>0.05 - 0.002 mm</td></tr> <tr><td>% Clay:</td><td>&lt; 0.002 mm</td></tr> </tbody> </table>			Particle Size	% Sand:	2.0 - 0.05 mm	% Silt:	0.05 - 0.002 mm	% Clay:	< 0.002 mm	<b>USDA Soil Textural Classification</b> Loamy Sand																																																																																																		
	Particle Size																																																																																																											
% Sand:	2.0 - 0.05 mm																																																																																																											
% Silt:	0.05 - 0.002 mm																																																																																																											
% Clay:	< 0.002 mm																																																																																																											

All results apply only to actual locations and materials tested. As a mutual protection to clients, the public and ourselves, all reports are submitted as the confidential property of clients, and authorization for publication of statements, conclusions or extracts from or regarding our reports is reserved pending our written approval.

**Comments:** \_\_\_\_\_

\_\_\_\_\_

\_\_\_\_\_

**Reviewed by:** 

\_\_\_\_\_

Meghan Blodgett-Carrillo

# Direct Shear Test Results:

ASTM D-3080



Project: Q.C. - Lower Duwamish Waterway  
 Project Number: 21B233  
 Laboratory Sample ID: B21-1704  
 Sample Date: 7/14/2021  
 Test Date: 9/17/2021  
 Technician: M. Carrillo

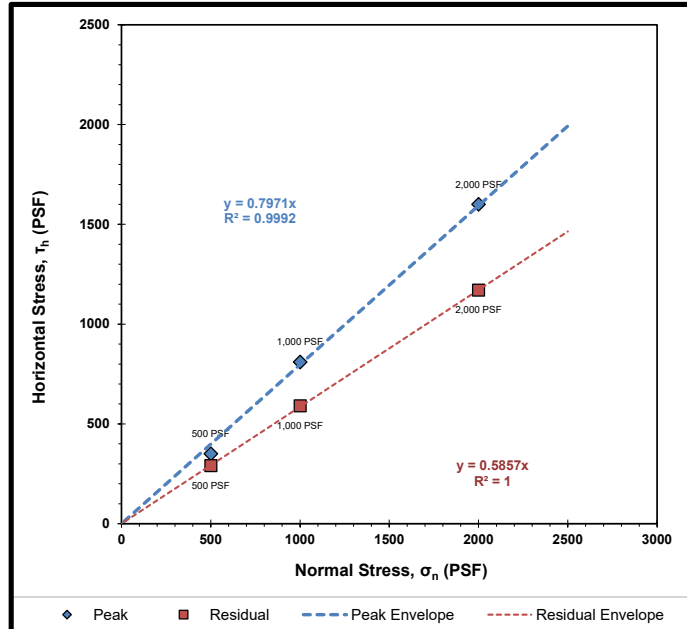
Sample Source: LDW21-GT18-GB-16.5-21.4 ft  
 Visual Soil Description: brown silty sand  
 Type of Specimen: Remolded Cylindrical Shear Box  
 Specimen Diameter (in): 2.5  
 Specimen Height (in): 1  
 Rate of Strain (in/min): 0.0208  
 Estimated Specific Gravity of Solids: 2.65

Summary of Sample Data: $\sigma_n=500$ PSF		
Initial Moisture Content (%)	29.4	
	Initial	Post-Consolidation
Dry Density (PCF):	107.0	107.9
Void Ratio:	0.575	0.562
Porosity (%):	36.5	36.0
Degree of Saturation (%):	saturated	saturated

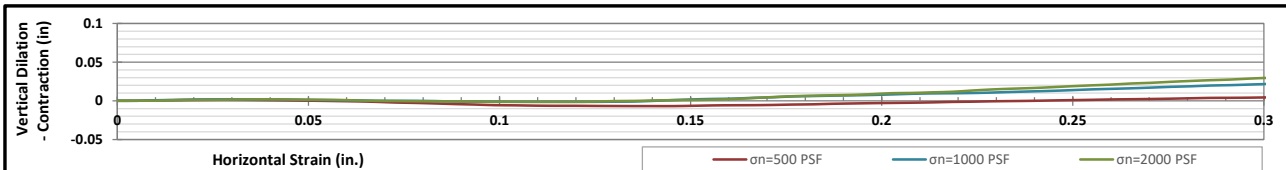
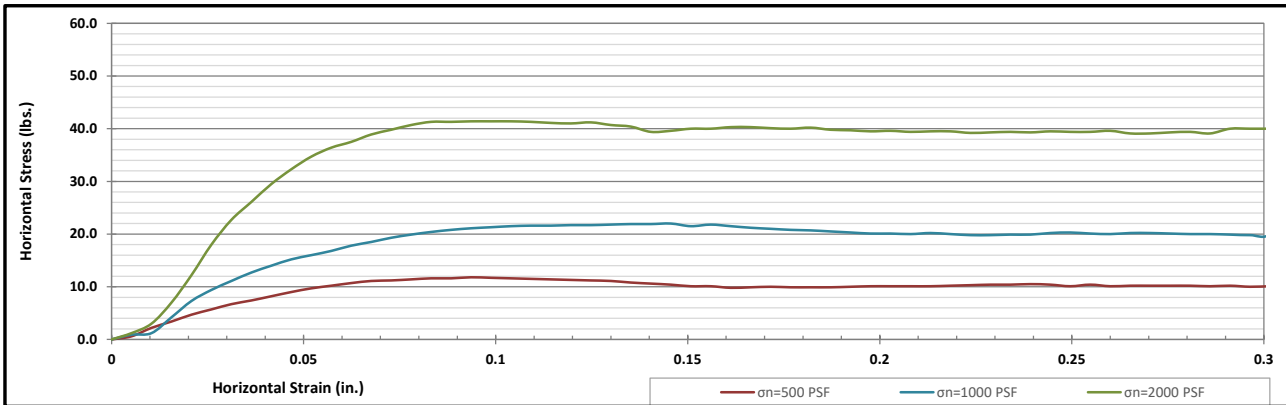
Summary of Sample Data: $\sigma_n=1000$ PSF		
Initial Moisture Content (%)	28.3	
	Initial	Post-Consolidation
Dry Density (PCF):	107.4	109.9
Void Ratio:	0.569	0.533
Porosity (%):	36.3	34.8
Degree of Saturation (%):	saturated	saturated

Summary of Sample Data: $\sigma_n=2000$ PSF		
Initial Moisture Content (%)	29.0	
	Initial	Post-Consolidation
Dry Density (PCF):	106.9	110.5
Void Ratio:	0.576	0.525
Porosity (%):	36.5	34.4
Degree of Saturation (%):	saturated	saturated

ESTIMATED STRENGTH PARAMETERS		
	PEAK	RESIDUAL
Angle of Internal Friction, $\phi$ (°):	39	30
Cohesion (PSF):	0	0



Failure Envelope Test Values:			
Normal Stress, $\sigma_n$ (PSF):	500	1000	2000
Peak Horizontal Stress, $\tau_h$ (PSF):	350	810	1600
Residual Horizontal Stress, $\tau_h$ (PSF):	290	590	1170



Corporate • 777 Chrysler Drive • Burlington, WA 98233 • Phone 360.755.1990 • Fax 360.755.1980  
 SW Region • 2118 Black Lake Blvd. S.W. • Olympia, WA 98512 • Phone 360.534.9777 • Fax 360.534.9779  
 NW Region • 805 Dupont, Suite #5 • Bellingham, WA 98225 • Phone 360.647.6061 • Fax 360.647.8111  
 Kitsap Region • 5451 N.W. Newberry Hill Road, Suite 101 • Silverdale, WA 98383 • Phone/Fax 360.698.6787

Visit our website: [www.mtc-inc.net](http://www.mtc-inc.net)

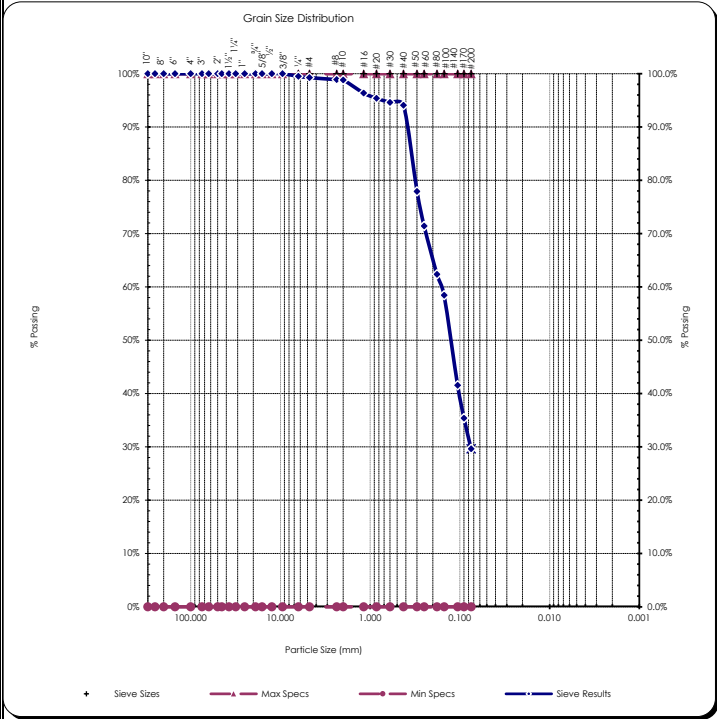


# Sieve Report

<b>Project:</b> Q.C. - Lower Duwamish Waterway <b>Project #:</b> 21B233 <b>Client:</b> Anchor QEA <b>Source:</b> LDW21-GT18-GB-21.4-26.5 ft <b>Sample#:</b> B21-1705	<b>Date Received:</b> 29-Jul-21 <b>Sampled By:</b> Client <b>Date Tested:</b> 13-Sep-21 <b>Tested By:</b> C. Kriss	<b>Unified Soil Classification System, ASTM-2487</b> SM, Silty Sand <b>Sample Color:</b> brown	 <b>ACCREDITED</b> Certificate #: 1366.01
--	---	---	---

<b>ASTM D2216, ASTM D2419, ASTM D4318, ASTM D5281</b>			
<b>Specifications</b> No Specs <b>Sample Meets Specs ?</b> N/A	D <sub>(5)</sub> = 0.013 mm D <sub>(10)</sub> = 0.025 mm D <sub>(15)</sub> = 0.038 mm D <sub>(30)</sub> = 0.076 mm D <sub>(50)</sub> = 0.128 mm D <sub>(60)</sub> = 0.162 mm D <sub>(90)</sub> = 0.393 mm Dust Ratio = 23/73	% Gravel = 0.7% % Sand = 69.6% % Silt & Clay = 29.7% Liquid Limit = n/a Plasticity Index = n/a Sand Equivalent = n/a Fracture %, 1 Face = n/a Fracture %, 2+ Faces = n/a	Coeff. of Curvature, C <sub>c</sub> = 1.41 Coeff. of Uniformity, C <sub>u</sub> = 6.40 Fineness Modulus = 0.74 Plastic Limit = n/a Moisture %, as sampled = 38.4% Req'd Sand Equivalent = Req'd Fracture %, 1 Face = Req'd Fracture %, 2+ Faces =

<b>ASTM C136, ASTM D6913, ASTM C117</b>					
<b>Sieve Size</b>		<b>Actual Cumulative Percent Passing</b>	<b>Interpolated Cumulative Percent Passing</b>	<b>Specs Max</b>	<b>Specs Min</b>
<b>US</b>	<b>Metric</b>				
12.00"	300.00		100%	100.0%	0.0%
10.00"	250.00		100%	100.0%	0.0%
8.00"	200.00		100%	100.0%	0.0%
6.00"	150.00		100%	100.0%	0.0%
4.00"	100.00		100%	100.0%	0.0%
3.00"	75.00		100%	100.0%	0.0%
2.50"	63.00		100%	100.0%	0.0%
2.00"	50.00	100%	100%	100.0%	0.0%
1.75"	45.00		100%	100.0%	0.0%
1.50"	37.50		100%	100.0%	0.0%
1.25"	31.50		100%	100.0%	0.0%
1.00"	25.00	100%	100%	100.0%	0.0%
3/4"	19.00	100%	100%	100.0%	0.0%
5/8"	16.00		100%	100.0%	0.0%
1/2"	12.50	100%	100%	100.0%	0.0%
3/8"	9.50	100%	100%	100.0%	0.0%
1/4"	6.30		100%	100.0%	0.0%
#4	4.75	99%	99%	100.0%	0.0%
#8	2.36		99%	100.0%	0.0%
#10	2.00	99%	99%	100.0%	0.0%
#16	1.18		96%	100.0%	0.0%
#20	0.850		95%	100.0%	0.0%
#30	0.600		95%	100.0%	0.0%
#40	0.425	94%	94%	100.0%	0.0%
#50	0.300		78%	100.0%	0.0%
#60	0.250		71%	100.0%	0.0%
#80	0.180		62%	100.0%	0.0%
#100	0.150	58%	58%	100.0%	0.0%
#140	0.106		42%	100.0%	0.0%
#170	0.090		35%	100.0%	0.0%
#200	0.075	29.7%	29.7%	100.0%	0.0%



Copyright Spears Engineering & Technical Services PS, 1996-98  
 All results apply only to actual locations and materials tested. As a mutual protection to clients, the public and ourselves, all reports are submitted as the confidential property of clients, and authorization for publication of statements, conclusions or extracts from or regarding our reports is reserved pending our written approval.

**Comments:** \_\_\_\_\_

Reviewed by:   
 Meghan Blodgett-Carrillo



**Client:** Anchor QEA  
**Address:** 21328 2nd Drive SE  
Bothell, WA 98021  
**Attn:** Garrett Timm  
**Revised on:** \_\_\_\_\_

**Date:** October 6, 2021  
**Project:** Q.C. - Lower Duwamish Waterway  
**Project #:** 21B233  
**Sample #:** B21-1787-1803  
**Date sampled:** 7-12-21 & 7-14-21

As requested MTC, Inc. has performed the following test(s) on the sample referenced above. The testing was performed in accordance with current applicable AASHTO or ASTM standards as indicated below. The results obtained in our laboratory were as follows below or on the attached pages:

	Test(s) Performed:	Test Results		Test(s) Performed:	Test Results
X	Sieve Analysis	Please See Attached Reports		Sulfate Soundness	
	Proctor			Bulk Density & Voids	
	Sand Equivalent			WSDOT Degradation	
	Fracture Count			LA Abrasion	
X	Moisture Content	Please See Attached Report	X	Direct Shear	Please See Attached Reports
	Specific Gravity, Coarse		X	Specific Gravity, Soils	Please See Attached Reports
	Specific Gravity, Fine				
X	Hydrometer Analysis	Please See Attached Reports			
X	Atterberg Limits	Please See Attached Reports			

If you have any questions concerning the test results, the procedures used, or if we can be of any further assistance please call on us at the number below.

Respectfully Submitted,  
 Meghan Blodgett-Carrillo  
 WABO Supervising Laboratory Technician




## Moisture Content - ASTM C566, ASTM D2216

**Project:** Q.C. - Lower Duwamish Waterway  
**Project #:** 21B233  
**Date Received:** July 29, 2021  
**Date Tested:** September 20, 2021

**Client:** Anchor QEA  
**Sampled by:** Client  
**Tested by:** A. Eifrig

Sample #	Location	Tare	Wet + Tare	Dry + Tare	Wgt. Of Moisture	Wgt. Of Soil	% Moisture
B21-1787	LDW21-GT15-GB-0-7.5 ft	233.4	1016.2	787.2	229.0	553.8	41.4%
B21-1788	LDW21-GT15-GB-7.5-9 ft	306.7	450.8	422.5	28.3	115.8	24.4%
B21-1789	LDW21-GT15-GB-7.5-15 ft	236.2	1288.2	1043.0	245.2	806.8	30.4%
B21-1790	LDW21-GT15-GB-15-17.5 ft	303.3	997.2	810.9	186.3	507.6	36.7%
B21-1791	LDW21-GT15-GB-17.5-19 ft	311.1	465.1	434.0	31.1	122.9	25.3%
B21-1792	LDW21-GT15-GB-17.5-25.4 ft	270.2	882.6	747.4	135.2	477.2	28.3%
B21-1793	LDW21-GT15-GB-25.4-27.5 ft	260.6	1270.0	1036.1	233.9	775.5	30.2%
B21-1794	LDW21-GT15-GB-27.5-29 ft	222.9	616.1	520.8	95.3	297.9	32.0%
B21-1795	LDW21-GT29-GB-0-1.5 ft	225.1	949.8	644.5	305.3	419.4	72.8%
B21-1796	LDW21-GT29-GB-0-10.6 ft	221.7	746.6	548.6	198.0	326.9	60.6%
B21-1797	LDW21-GT29-GB-11-12.5 ft	221.4	1082.5	801.0	281.5	579.6	48.6%
B21-1798	LDW21-GT29-GB-11-21 ft	224.4	738.0	646.6	91.4	422.2	21.6%
B21-1799	LDW21-GT29-GB-21-22.5 ft	222.3	408.6	349.3	59.3	127.0	46.7%
B21-1800	LDW21-GT29-GB-21-26 ft	233.8	1031.7	903.6	128.1	669.8	19.1%
B21-1801	LDW21-GT29-GB-26-28.9 ft	229.1	776.5	629.0	147.5	399.9	36.9%
B21-1802	LDW21-GT29-GB-28.9-31 ft	188.4	1285.9	988.6	297.3	800.2	37.2%
B21-1803	LDW21-GT29-GB-31-32.5 ft	225.3	925.7	756.5	169.2	531.2	31.9%

All results apply only to actual locations and materials tested. As a mutual protection to clients, the public and ourselves, all reports are submitted as the confidential property of clients, and authorization for publication of statements, conclusions or extracts from or regarding our reports is reserved pending our written approval.

Reviewed by:   
 Meghan Blodgett-Carrillo



### Moisture Content - ASTM D854

**Project:** Q.C. - Lower Duwamish Waterway

**Client:** Anchor QEA

**Project #:** 21B233

**Date Received:** July 29, 2021


**Sampled by:** Client

**Date Tested:** September 20, 2021

**Tested by:** A. Eifrig

Sample #	Location	Tare	Dry Soil + Tare	Mass of Dry Soil	Pycno ID	Mass of Pycno	Volume of Pycno	Density of Water @ Tx	Mass of Pycno filled w/ water & soils	Mass of Pycno filled w/ water	Temp. of Water, 0.1 *C	SpG of Soils	Temp. Correction Factor	Corrected SpG
B21-1787	LDW21-GT15-GB-0-7.5 ft	584.26	658.50	74.2	TSA-014	192.3	499.5	0.99749	735.04	690.54	23.2	2.4966051	0.99929	2.4948325
B21-1792	LDW21-GT15-GB-17.5-25.4 ft	493.62	594.11	100.5	TSA-016	197.2	499.5	0.99754	757.82	695.45	23.0	2.6360571	0.99933	2.634291
B21-1793	LDW21-GT15-GB-25.4-27.5 ft	500.82	575.98	75.2	TSA-022	198.0	499.5	0.99749	740.87	696.19	23.2	2.4661721	0.99929	2.4644211
B21-1796	LDW21-GT29-GB-0-10.6 ft	600.79	675.86	75.1	TSA-012	180.4	499.5	0.99752	722.04	678.65	23.1	2.3695318	0.99931	2.3678968
B21-1798	LDW21-GT29-GB-11-21 ft	584.33	685.35	101.0	TSA-017	187.9	499.4	0.99749	749.71	686.04	23.2	2.7049457	0.99929	2.7030252

All results apply only to actual locations and materials tested. As a mutual protection to clients, the public and ourselves, all reports are submitted as the confidential property of clients, and authorization for publication of statements, conclusions or extracts from or regarding our reports is reserved pending our written approval.

Reviewed by:   
 Meghan Blodgett-Carrillo

## ASTM D4318 - Liquid Limit, Plastic Limit and Plasticity Index of Soils

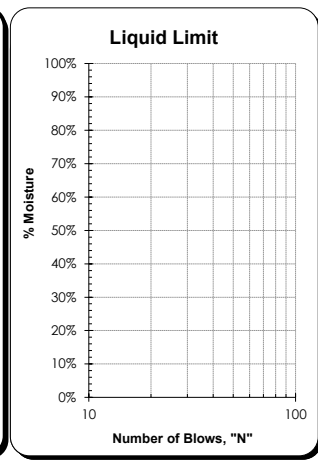
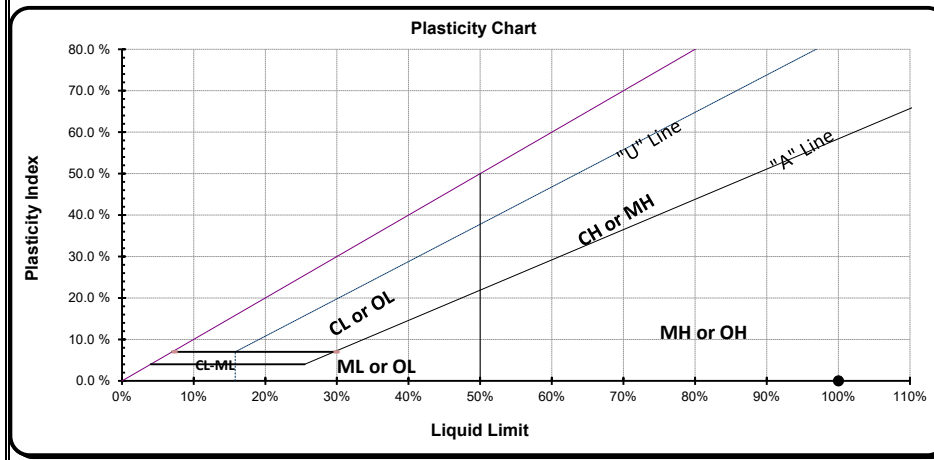
<b>Project:</b> Q.C. - Lower Duwamish Waterway <b>Project #:</b> 21B233 <b>Client:</b> Anchor QEA <b>Source:</b> LDW21-GT15-GB-0-7.5 ft <b>Sample #:</b> B21-1787	<b>Date Received:</b> 29-Jul-21 <b>Sampled By:</b> Client <b>Date Tested:</b> 20-Sep-21 <b>Tested By:</b> C. Kriss	<b>Visual Identification</b> Silt with Sand and Clay <b>Sample Color</b> brown
---	---	---

Liquid Limit Determination						
	#1	#2	#3	#4	#5	#6
Weight of Wet Soils + Pan:	Liquid limit cannot be established					
Weight of Dry Soils + Pan:						
Weight of Pan:						
Weight of Dry Soils:						
Weight of Moisture:						
% Moisture:						
Number of Blows:						



**Liquid Limit @ 25 Blows:** N/A  
**Plastic Limit:** N/A  
**Plasticity Index, I<sub>p</sub>:** N/A

Plastic Limit Determination						
	#1	#2	#3	#4	#5	#6
Weight of Wet Soils + Pan:	Plastic limit cannot be determined					
Weight of Dry Soils + Pan:						
Weight of Pan:						
Weight of Dry Soils:						
Weight of Moisture:						
% Moisture:						



All results apply only to actual locations and materials tested. As a mutual protection to clients, the public and ourselves, all reports are submitted as the confidential property of clients, and authorization for publication of statements, conclusions or extracts from or regarding our reports is reserved pending our written approval.

**Comments:** Liquid limit cannot be established as the material displays rapid dilation upon spreading into the cup. At lower moistures the material does not spread into the liquid limit cup without tearing the soil cake. Plastic limit cannot be determined as the material does not roll down to 1/8" threads before cracking or crumbling. Non-plastic.

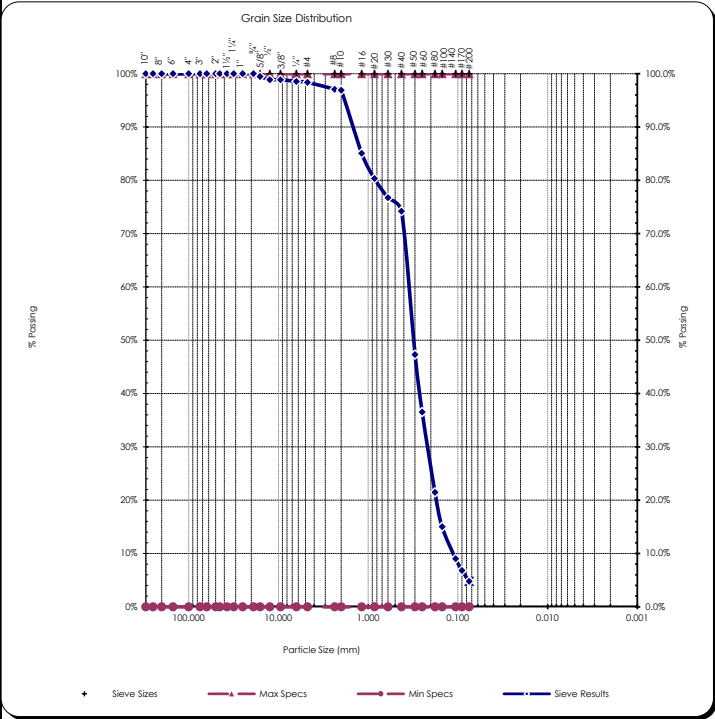
Reviewed by: \_\_\_\_\_  
 Meghan Blodgett-Carrillo

# Sieve Report

<b>Project:</b> Q.C. - Lower Duwamish Waterway <b>Project #:</b> 21B233 <b>Client:</b> Anchor QEA <b>Source:</b> LDW21-GT15-GB-7.5-15 ft <b>Sample#:</b> B21-1789	<b>Date Received:</b> 29-Jul-21 <b>Sampled By:</b> Client <b>Date Tested:</b> 20-Sep-21 <b>Tested By:</b> C. Kriss	<b>Unified Soil Classification System, ASTM-2487</b> SP, Poorly graded Sand <b>Sample Color:</b> brown	 <b>ACCREDITED</b> Certificate #: 1366.01
---	---	---	---

<b>ASTM D2216, ASTM D2419, ASTM D4318, ASTM D5281</b>			
<b>Specifications</b> No Specs <b>Sample Meets Specs ?</b> N/A	D <sub>(5)</sub> = 0.076 mm D <sub>(10)</sub> = 0.113 mm D <sub>(15)</sub> = 0.150 mm D <sub>(30)</sub> = 0.220 mm D <sub>(50)</sub> = 0.313 mm D <sub>(60)</sub> = 0.359 mm D <sub>(90)</sub> = 1.522 mm Dust Ratio = 2/31	% Gravel = 1.6% % Sand = 93.6% % Silt & Clay = 4.8% Liquid Limit = n/a Plasticity Index = n/a Sand Equivalent = n/a Fracture %, 1 Face = n/a Fracture %, 2+ Faces = n/a	Coeff. of Curvature, C <sub>c</sub> = 1.19 Coeff. of Uniformity, C <sub>u</sub> = 3.17 Fineness Modulus = 1.81 Plastic Limit = n/a Moisture %, as sampled = 30.4% Req'd Sand Equivalent = Req'd Fracture %, 1 Face = Req'd Fracture %, 2+ Faces =

<b>ASTM C136, ASTM D6913, ASTM C117</b>					
Sieve Size		Actual Cumulative Percent Passing	Interpolated Cumulative Percent Passing	Specs Max	Specs Min
US	Metric				
12.00"	300.00		100%	100.0%	0.0%
10.00"	250.00		100%	100.0%	0.0%
8.00"	200.00		100%	100.0%	0.0%
6.00"	150.00		100%	100.0%	0.0%
4.00"	100.00		100%	100.0%	0.0%
3.00"	75.00		100%	100.0%	0.0%
2.50"	63.00		100%	100.0%	0.0%
2.00"	50.00	100%	100%	100.0%	0.0%
1.75"	45.00	100%	100%	100.0%	0.0%
1.50"	37.50	100%	100%	100.0%	0.0%
1.25"	31.50	100%	100%	100.0%	0.0%
1.00"	25.00	100%	100%	100.0%	0.0%
3/4"	19.00	100%	100%	100.0%	0.0%
5/8"	16.00	99%	99%	100.0%	0.0%
1/2"	12.50	99%	99%	100.0%	0.0%
3/8"	9.50	99%	99%	100.0%	0.0%
1/4"	6.30	99%	99%	100.0%	0.0%
#4	4.75	98%	98%	100.0%	0.0%
#8	2.36	97%	97%	100.0%	0.0%
#10	2.00	97%	97%	100.0%	0.0%
#16	1.18	85%	85%	100.0%	0.0%
#20	0.850	80%	80%	100.0%	0.0%
#30	0.600	77%	77%	100.0%	0.0%
#40	0.425	74%	74%	100.0%	0.0%
#50	0.300	47%	47%	100.0%	0.0%
#60	0.250	37%	37%	100.0%	0.0%
#80	0.180	21%	21%	100.0%	0.0%
#100	0.150	15%	15%	100.0%	0.0%
#140	0.106	9%	9%	100.0%	0.0%
#170	0.090	7%	7%	100.0%	0.0%
#200	0.075	4.8%	4.8%	100.0%	0.0%



Copyright Spears Engineering & Technical Services PS, 1996-98

All results apply only to actual locations and materials tested. As a mutual protection to clients, the public and ourselves, all reports are submitted as the confidential property of clients, and authorization for publication of statements, conclusions or extracts from or regarding our reports is reserved pending our written approval.

**Comments:** \_\_\_\_\_

Reviewed by:   
 Meghan Blodgett-Carrillo



# Direct Shear Test Results:

ASTM D-3080



Project: Q.C. - Lower Duwamish Waterway  
 Project Number: 21B233  
 Laboratory Sample ID: B21-1789  
 Sample Date: 7/12/2021  
 Test Date: 9/28/2021  
 Technician: M. Carrillo

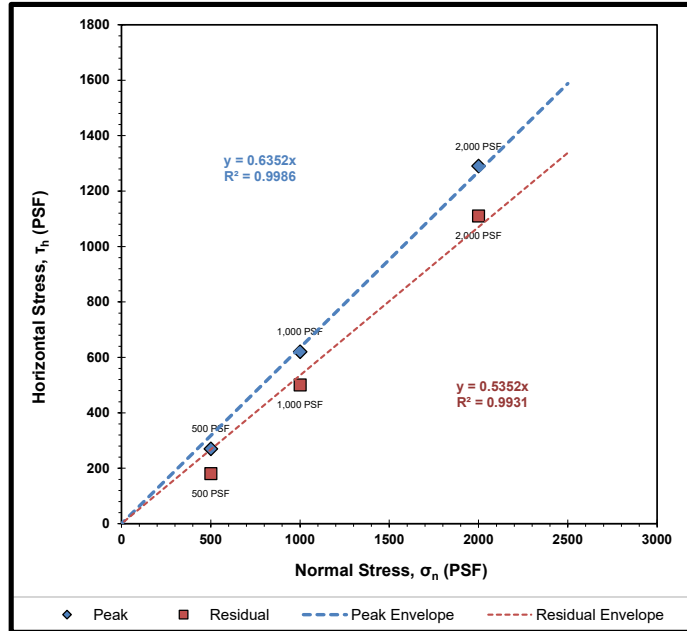
Sample Source: LDW21-GT15-GB-7.5-15 ft  
 Visual Soil Description: brown sand with silt  
 Type of Specimen: Remolded Cylindrical Shear Box  
 Specimen Diameter (in): 2.5  
 Specimen Height (in): 1  
 Rate of Strain (in/min): 0.0208  
 Estimated Specific Gravity of Solids: 2.65

Summary of Sample Data: $\sigma_n=500$ PSF		
Initial Moisture Content (%):	26.1	
	Initial	Post-Consolidation
Dry Density (PCF):	109.2	110.2
Void Ratio:	0.543	0.528
Porosity (%):	35.2	34.6
Degree of Saturation (%):	saturated	saturated

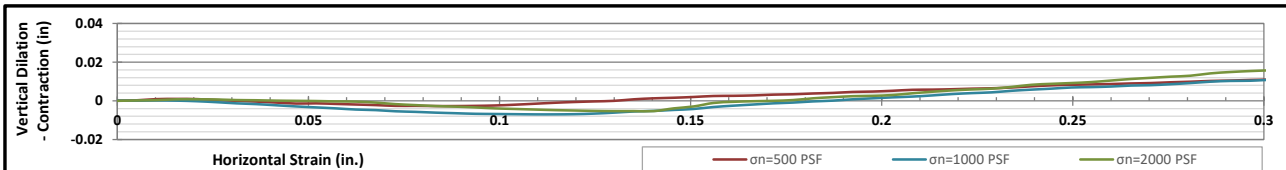
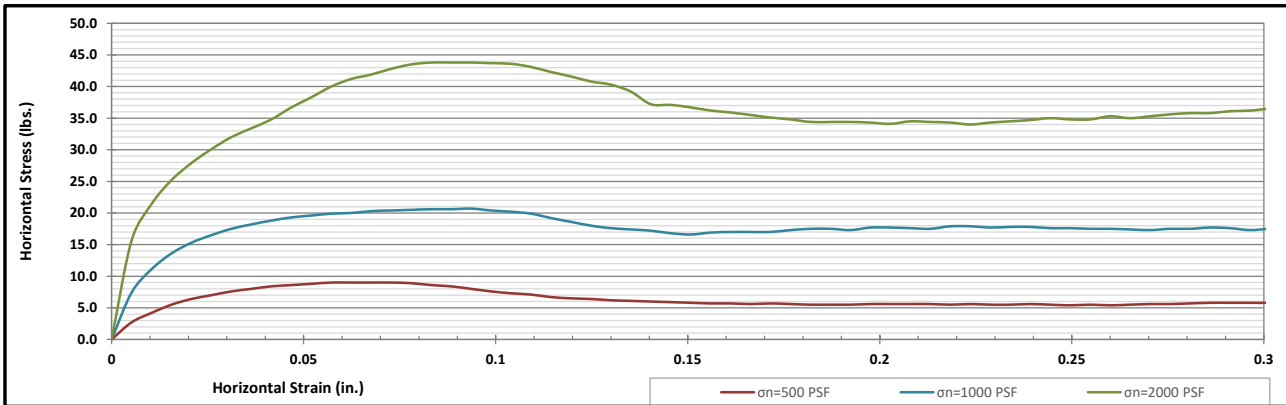
Summary of Sample Data: $\sigma_n=1000$ PSF		
Initial Moisture Content (%):	25.9	
	Initial	Post-Consolidation
Dry Density (PCF):	108.7	110.2
Void Ratio:	0.550	0.529
Porosity (%):	35.5	34.6
Degree of Saturation (%):	saturated	saturated

Summary of Sample Data: $\sigma_n=2000$ PSF		
Initial Moisture Content (%):	25.9	
	Initial	Post-Consolidation
Dry Density (PCF):	110.0	114.4
Void Ratio:	0.532	0.473
Porosity (%):	34.7	32.1
Degree of Saturation (%):	saturated	saturated

ESTIMATED STRENGTH PARAMETERS		
	PEAK	RESIDUAL
Angle of Internal Friction, $\phi$ (°):	32	28
Cohesion (PSF):	0	0



Failure Envelope Test Values:			
Normal Stress, $\sigma_n$ (PSF):	500	1000	2000
Peak Horizontal Stress, $\tau_h$ (PSF):	270	620	1290
Residual Horizontal Stress, $\tau_h$ (PSF):	180	500	1110



Corporate • 777 Chrysler Drive • Burlington, WA 98233 • Phone 360.755.1990 • Fax 360.755.1980  
 SW Region • 2118 Black Lake Blvd. S.W. • Olympia, WA 98512 • Phone 360.534.9777 • Fax 360.534.9779  
 NW Region • 805 Dupont, Suite #5 • Bellingham, WA 98225 • Phone 360.647.6061 • Fax 360.647.8111  
 Kitsap Region • 5451 N.W. Newberry Hill Road, Suite 101 • Silverdale, WA 98383 • Phone/Fax 360.698.6787

Visit our website: [www.mtc-inc.net](http://www.mtc-inc.net)

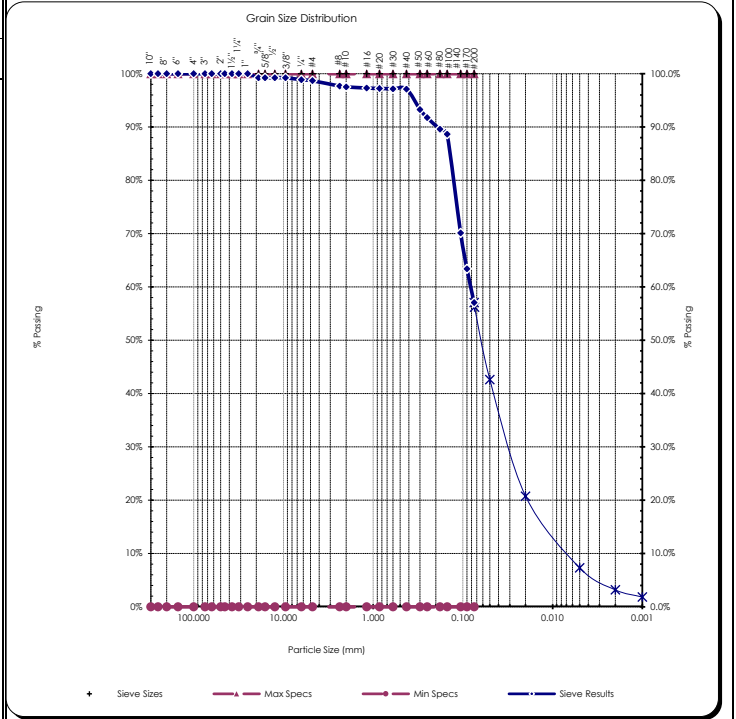
# Sieve Report

<b>Project:</b> Q.C. - Lower Duwamish Waterway <b>Project #:</b> 21B233 <b>Client:</b> Anchor QEA <b>Source:</b> LDW21-GT15-GB-15-17.5 ft <b>Sample#:</b> B21-1790	<b>Date Received:</b> 29-Jul-21 <b>Sampled By:</b> Client <b>Date Tested:</b> 20-Sep-21 <b>Tested By:</b> C. Kriss	<b>Visual Identification</b> Sandy Silt with Clay <b>Sample Color:</b> brown	 <b>ACCREDITED</b> Certificate #: 1366.01
--	---	---	---

<b>ASTM D2216, ASTM D2419, ASTM D4318, ASTM D5281</b>			
<b>Specifications</b> No Specs <b>Sample Meets Specs ?</b> N/A	D <sub>(5)</sub> = 0.004 mm D <sub>(10)</sub> = 0.006 mm D <sub>(15)</sub> = 0.012 mm D <sub>(30)</sub> = 0.039 mm D <sub>(50)</sub> = 0.067 mm D <sub>(60)</sub> = 0.082 mm D <sub>(90)</sub> = 0.193 mm Dust Ratio = 47/80	% Gravel = 1.3% % Sand = 41.6% % Silt & Clay = 57.1% Liquid Limit = n/a Plasticity Index = n/a Sand Equivalent = n/a Fracture %, 1 Face = n/a Fracture %, 2+ Faces = n/a	Coeff. of Curvature, C <sub>c</sub> = 2.92 Coeff. of Uniformity, C <sub>u</sub> = 12.63 Fineness Modulus = 0.29 Plastic Limit = n/a Moisture %, as sampled = 36.7% Req'd Sand Equivalent = Req'd Fracture %, 1 Face = Req'd Fracture %, 2+ Faces =

**ASTM C136, ASTM D6913, ASTM C117**

Sieve Size		Actual Cumulative Percent Passing	Interpolated Cumulative Percent Passing	Specs Max	Specs Min
US	Metric				
12.00"	300.00		100%	100.0%	0.0%
10.00"	250.00		100%	100.0%	0.0%
8.00"	200.00		100%	100.0%	0.0%
6.00"	150.00		100%	100.0%	0.0%
4.00"	100.00		100%	100.0%	0.0%
3.00"	75.00		100%	100.0%	0.0%
2.50"	63.00		100%	100.0%	0.0%
2.00"	50.00	100%	100%	100.0%	0.0%
1.75"	45.00		100%	100.0%	0.0%
1.50"	37.50		100%	100.0%	0.0%
1.25"	31.50		100%	100.0%	0.0%
1.00"	25.00	100%	100%	100.0%	0.0%
3/4"	19.00	99%	99%	100.0%	0.0%
5/8"	16.00		99%	100.0%	0.0%
1/2"	12.50	99%	99%	100.0%	0.0%
3/8"	9.50	99%	99%	100.0%	0.0%
1/4"	6.30		99%	100.0%	0.0%
#4	4.75	99%	99%	100.0%	0.0%
#8	2.36		98%	100.0%	0.0%
#10	2.00	98%	98%	100.0%	0.0%
#16	1.18		97%	100.0%	0.0%
#20	0.850		97%	100.0%	0.0%
#30	0.600		97%	100.0%	0.0%
#40	0.425	97%	97%	100.0%	0.0%
#50	0.300		93%	100.0%	0.0%
#60	0.250		92%	100.0%	0.0%
#80	0.180		90%	100.0%	0.0%
#100	0.150	89%	89%	100.0%	0.0%
#140	0.106		70%	100.0%	0.0%
#170	0.090		63%	100.0%	0.0%
#200	0.075	57.1%	57.1%	100.0%	0.0%



Copyright Spears Engineering & Technical Services PS, 1996-98  
 All results apply only to actual locations and materials tested. As a mutual protection to clients, the public and ourselves, all reports are submitted as the confidential property of clients, and authorization for publication of statements, conclusions or extracts from or regarding our reports is reserved pending our written approval.

**Comments:** \_\_\_\_\_

Reviewed by:   
 Meghan Blodgett-Carrillo

## Hydrometer Report

<b>Project:</b> Q.C. - Lower Duwamish Waterway <b>Project #:</b> 21B233 <b>Client:</b> Anchor QEA <b>Source:</b> LDW21-GT15-GB-15-17.5 ft <b>Sample#:</b> B21-1790	<b>Date Received:</b> 29-Jul-21 <b>Sampled By:</b> Client <b>Date Tested:</b> 20-Sep-21 <b>Tested By:</b> C. Kriss	<b>Visual Identification</b> Sandy Silt with Clay <b>Sample Color</b> brown																																																																																																									
<b>ASTM D7928, HYDROMETER ANALYSIS</b>		<b>ASTM D6913</b>																																																																																																									
Assumed Sp Gr : 2.65 Sample Weight: 75.02 grams Hydroscopic Moist.: 1.96% Adj. Sample Wgt : 73.58 grams		<b>Sieve Analysis</b> <b>Grain Size Distribution</b>																																																																																																									
<table border="1" style="width: 100%; border-collapse: collapse;"> <thead> <tr> <th>Hydrometer Reading Minutes</th> <th>Corrected Reading</th> <th>Percent Passing</th> <th>Soils Particle Diameter</th> </tr> </thead> <tbody> <tr><td>1</td><td>25.5</td><td>33.8%</td><td>0.0477 mm</td></tr> <tr><td>2</td><td>21</td><td>27.8%</td><td>0.0347 mm</td></tr> <tr><td>5</td><td>17</td><td>22.5%</td><td>0.0224 mm</td></tr> <tr><td>15</td><td>12</td><td>15.9%</td><td>0.0133 mm</td></tr> <tr><td>30</td><td>10</td><td>13.3%</td><td>0.0096 mm</td></tr> <tr><td>60</td><td>8</td><td>10.6%</td><td>0.0068 mm</td></tr> <tr><td>240</td><td>3.5</td><td>4.6%</td><td>0.0035 mm</td></tr> <tr><td>1440</td><td>2</td><td>2.7%</td><td>0.0014 mm</td></tr> </tbody> </table> <p>                 % Gravel: 1.3%                      <b>Liquid Limit:</b> n/a                  % Sand: 41.6%                      <b>Plastic Limit:</b> n/a                  % Silt: 49.7%                      <b>Plasticity Index:</b> n/a                  % Clay: 7.3%             </p>	Hydrometer Reading Minutes	Corrected Reading	Percent Passing	Soils Particle Diameter	1	25.5	33.8%	0.0477 mm	2	21	27.8%	0.0347 mm	5	17	22.5%	0.0224 mm	15	12	15.9%	0.0133 mm	30	10	13.3%	0.0096 mm	60	8	10.6%	0.0068 mm	240	3.5	4.6%	0.0035 mm	1440	2	2.7%	0.0014 mm		<table border="1" style="width: 100%; border-collapse: collapse;"> <thead> <tr> <th>Sieve Size</th> <th>Percent Passing</th> <th>Soils Particle Diameter</th> </tr> </thead> <tbody> <tr><td>3.0"</td><td>100%</td><td>75.000 mm</td></tr> <tr><td>2.0"</td><td>100%</td><td>50.000 mm</td></tr> <tr><td>1.5"</td><td>100%</td><td>37.500 mm</td></tr> <tr><td>1.25"</td><td>100%</td><td>31.500 mm</td></tr> <tr><td>1.0"</td><td>100%</td><td>25.000 mm</td></tr> <tr><td>3/4"</td><td>99%</td><td>19.000 mm</td></tr> <tr><td>5/8"</td><td>99%</td><td>16.000 mm</td></tr> <tr><td>1/2"</td><td>99%</td><td>12.500 mm</td></tr> <tr><td>3/8"</td><td>99%</td><td>9.500 mm</td></tr> <tr><td>1/4"</td><td>99%</td><td>6.300 mm</td></tr> <tr><td>#4</td><td>99%</td><td>4.750 mm</td></tr> <tr><td>#10</td><td>98%</td><td>2.000 mm</td></tr> <tr><td>#20</td><td>97%</td><td>0.850 mm</td></tr> <tr><td>#40</td><td>97%</td><td>0.425 mm</td></tr> <tr><td>#100</td><td>89%</td><td>0.150 mm</td></tr> <tr><td>#200</td><td>57.1%</td><td>0.075 mm</td></tr> <tr><td><b>Silts</b></td><td>56.2%</td><td>0.074 mm</td></tr> <tr><td></td><td>42.6%</td><td>0.050 mm</td></tr> <tr><td></td><td>20.8%</td><td>0.020 mm</td></tr> <tr><td><b>Clays</b></td><td>7.3%</td><td>0.005 mm</td></tr> <tr><td></td><td>3.2%</td><td>0.002 mm</td></tr> <tr><td><b>Colloids</b></td><td>1.8%</td><td>0.001 mm</td></tr> </tbody> </table>	Sieve Size	Percent Passing	Soils Particle Diameter	3.0"	100%	75.000 mm	2.0"	100%	50.000 mm	1.5"	100%	37.500 mm	1.25"	100%	31.500 mm	1.0"	100%	25.000 mm	3/4"	99%	19.000 mm	5/8"	99%	16.000 mm	1/2"	99%	12.500 mm	3/8"	99%	9.500 mm	1/4"	99%	6.300 mm	#4	99%	4.750 mm	#10	98%	2.000 mm	#20	97%	0.850 mm	#40	97%	0.425 mm	#100	89%	0.150 mm	#200	57.1%	0.075 mm	<b>Silts</b>	56.2%	0.074 mm		42.6%	0.050 mm		20.8%	0.020 mm	<b>Clays</b>	7.3%	0.005 mm		3.2%	0.002 mm	<b>Colloids</b>	1.8%	0.001 mm
Hydrometer Reading Minutes	Corrected Reading	Percent Passing	Soils Particle Diameter																																																																																																								
1	25.5	33.8%	0.0477 mm																																																																																																								
2	21	27.8%	0.0347 mm																																																																																																								
5	17	22.5%	0.0224 mm																																																																																																								
15	12	15.9%	0.0133 mm																																																																																																								
30	10	13.3%	0.0096 mm																																																																																																								
60	8	10.6%	0.0068 mm																																																																																																								
240	3.5	4.6%	0.0035 mm																																																																																																								
1440	2	2.7%	0.0014 mm																																																																																																								
Sieve Size	Percent Passing	Soils Particle Diameter																																																																																																									
3.0"	100%	75.000 mm																																																																																																									
2.0"	100%	50.000 mm																																																																																																									
1.5"	100%	37.500 mm																																																																																																									
1.25"	100%	31.500 mm																																																																																																									
1.0"	100%	25.000 mm																																																																																																									
3/4"	99%	19.000 mm																																																																																																									
5/8"	99%	16.000 mm																																																																																																									
1/2"	99%	12.500 mm																																																																																																									
3/8"	99%	9.500 mm																																																																																																									
1/4"	99%	6.300 mm																																																																																																									
#4	99%	4.750 mm																																																																																																									
#10	98%	2.000 mm																																																																																																									
#20	97%	0.850 mm																																																																																																									
#40	97%	0.425 mm																																																																																																									
#100	89%	0.150 mm																																																																																																									
#200	57.1%	0.075 mm																																																																																																									
<b>Silts</b>	56.2%	0.074 mm																																																																																																									
	42.6%	0.050 mm																																																																																																									
	20.8%	0.020 mm																																																																																																									
<b>Clays</b>	7.3%	0.005 mm																																																																																																									
	3.2%	0.002 mm																																																																																																									
<b>Colloids</b>	1.8%	0.001 mm																																																																																																									
<b>USDA Soil Textural Classification</b>																																																																																																											
<table border="1" style="width: 100%; border-collapse: collapse;"> <thead> <tr> <th></th> <th>Particle Size</th> </tr> </thead> <tbody> <tr><td>% Sand:</td><td>2.0 - 0.05 mm</td></tr> <tr><td>% Silt:</td><td>0.05 - 0.002 mm</td></tr> <tr><td>% Clay:</td><td>&lt; 0.002 mm</td></tr> </tbody> </table> <p style="text-align: center;"><b>USDA Soil Textural Classification</b> Sandy Loam</p>		Particle Size	% Sand:	2.0 - 0.05 mm	% Silt:	0.05 - 0.002 mm	% Clay:	< 0.002 mm																																																																																																			
	Particle Size																																																																																																										
% Sand:	2.0 - 0.05 mm																																																																																																										
% Silt:	0.05 - 0.002 mm																																																																																																										
% Clay:	< 0.002 mm																																																																																																										

All results apply only to actual locations and materials tested. As a mutual protection to clients, the public and ourselves, all reports are submitted as the confidential property of clients, and authorization for publication of statements, conclusions or extracts from or regarding our reports is reserved pending our written approval.

**Comments:** \_\_\_\_\_

\_\_\_\_\_

\_\_\_\_\_

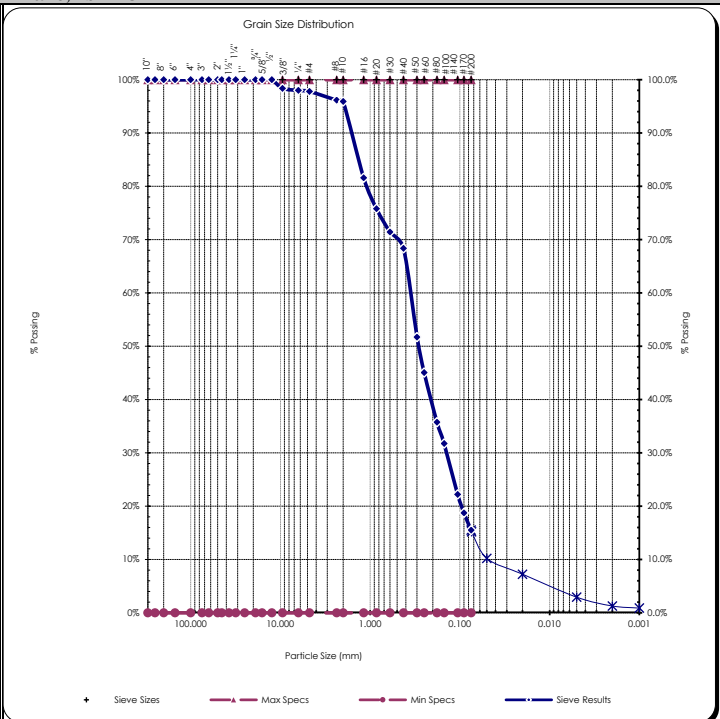
**Reviewed by:** \_\_\_\_\_  
 Meghan Blodgett-Carrillo

# Sieve Report

<b>Project:</b> Q.C. - Lower Duwamish Waterway <b>Project #:</b> 21B233 <b>Client:</b> Anchor QEA <b>Source:</b> LDW21-GT15-GB-17.5-19 ft <b>Sample#:</b> B21-1791	<b>Date Received:</b> 29-Jul-21 <b>Sampled By:</b> Client <b>Date Tested:</b> 20-Sep-21 <b>Tested By:</b> C. Kriss	<b>Unified Soils Classification System, ASTM D-2487</b> SM, Silty Sand <b>Sample Color:</b> brown	 <b>ACCREDITED</b> Certificate #: 1366.01
--	---	--	---

<b>ASTM D2216, ASTM D2419, ASTM D4318, ASTM D5281</b>			
<b>Specifications</b> No Specs <b>Sample Meets Specs ? N/A</b>	D <sub>(5)</sub> = 0.007 mm D <sub>(10)</sub> = 0.056 mm D <sub>(15)</sub> = 0.073 mm D <sub>(30)</sub> = 0.142 mm D <sub>(50)</sub> = 0.287 mm D <sub>(60)</sub> = 0.362 mm D <sub>(90)</sub> = 1.662 mm Dust Ratio = 22/97	% Gravel = 2.2% % Sand = 82.3% % Silt & Clay = 15.5% Liquid Limit = n/a Plasticity Index = n/a Sand Equivalent = n/a Fracture %, 1 Face = n/a Fracture %, 2+ Faces = n/a	Coeff. of Curvature, C <sub>c</sub> = 0.98 Coeff. of Uniformity, C <sub>u</sub> = 6.42 Fineness Modulus = 1.71 Plastic Limit = n/a Moisture %, as sampled = 25.3% Req'd Sand Equivalent = Req'd Fracture %, 1 Face = Req'd Fracture %, 2+ Faces =

<b>ASTM C136, ASTM D6913, ASTM C117</b>					
Sieve Size		Actual Cumulative Percent Passing	Interpolated Cumulative Percent Passing	Specs Max	Specs Min
US	Metric				
12.00"	300.00		100%	100.0%	0.0%
10.00"	250.00		100%	100.0%	0.0%
8.00"	200.00		100%	100.0%	0.0%
6.00"	150.00		100%	100.0%	0.0%
4.00"	100.00		100%	100.0%	0.0%
3.00"	75.00		100%	100.0%	0.0%
2.50"	63.00		100%	100.0%	0.0%
2.00"	50.00	100%	100%	100.0%	0.0%
1.75"	45.00	100%	100%	100.0%	0.0%
1.50"	37.50	100%	100%	100.0%	0.0%
1.25"	31.50	100%	100%	100.0%	0.0%
1.00"	25.00	100%	100%	100.0%	0.0%
3/4"	19.00	100%	100%	100.0%	0.0%
5/8"	16.00	100%	100%	100.0%	0.0%
1/2"	12.50	100%	100%	100.0%	0.0%
3/8"	9.50	98%	98%	100.0%	0.0%
1/4"	6.30	98%	98%	100.0%	0.0%
#4	4.75	98%	98%	100.0%	0.0%
#8	2.36	96%	96%	100.0%	0.0%
#10	2.00	96%	96%	100.0%	0.0%
#16	1.18	82%	82%	100.0%	0.0%
#20	0.850	76%	76%	100.0%	0.0%
#30	0.600	71%	71%	100.0%	0.0%
#40	0.425	68%	68%	100.0%	0.0%
#50	0.300	52%	52%	100.0%	0.0%
#60	0.250	45%	45%	100.0%	0.0%
#80	0.180	36%	36%	100.0%	0.0%
#100	0.150	32%	32%	100.0%	0.0%
#140	0.106	22%	22%	100.0%	0.0%
#170	0.090	19%	19%	100.0%	0.0%
#200	0.075	15.5%	15.5%	100.0%	0.0%




Copyright Spears Engineering & Technical Services PS, 1996-98  
 All results apply only to actual locations and materials tested. As a mutual protection to clients, the public and ourselves, all reports are submitted as the confidential property of clients, and authorization for publication of statements, conclusions or extracts from or regarding our reports is reserved pending our written approval.

**Comments:** \_\_\_\_\_

Reviewed by:   
 Meghan Blodgett-Carrillo



## Hydrometer Report

<b>Project:</b> Q.C. - Lower Duwamish Waterway <b>Project #:</b> 21B233 <b>Client :</b> Anchor QEA <b>Source:</b> LDW21-GT15-GB-17.5-19 ft <b>Sample#:</b> B21-1791	<b>Date Received:</b> 29-Jul-21 <b>Sampled By:</b> Client <b>Date Tested:</b> 20-Sep-21 <b>Tested By:</b> C. Kriss	<b>Unified Soils Classification System, ASTM D-2487</b> SM, Silty Sand <b>Sample Color</b> brown																																																																					
<b>ASTM D7928, HYDROMETER ANALYSIS</b>		<b>ASTM D6913</b>																																																																					
Assumed Sp Gr : 2.65 Sample Weight: 74.97 grams Hydrosopic Moist.: 1.06% Adj. Sample Wgt : 74.18 grams		<b>Sieve Analysis</b> <b>Grain Size Distribution</b>																																																																					
		<table border="1" style="width: 100%; border-collapse: collapse;"> <thead> <tr> <th>Sieve Size</th> <th>Percent Passing</th> <th>Soils Particle Diameter</th> </tr> </thead> <tbody> <tr><td>3.0"</td><td>100%</td><td>75.000 mm</td></tr> <tr><td>2.0"</td><td>100%</td><td>50.000 mm</td></tr> <tr><td>1.5"</td><td>100%</td><td>37.500 mm</td></tr> <tr><td>1.25"</td><td>100%</td><td>31.500 mm</td></tr> <tr><td>1.0"</td><td>100%</td><td>25.000 mm</td></tr> <tr><td>3/4"</td><td>100%</td><td>19.000 mm</td></tr> <tr><td>5/8"</td><td>100%</td><td>16.000 mm</td></tr> <tr><td>1/2"</td><td>100%</td><td>12.500 mm</td></tr> <tr><td>3/8"</td><td>98%</td><td>9.500 mm</td></tr> <tr><td>1/4"</td><td>98%</td><td>6.300 mm</td></tr> <tr><td>#4</td><td>98%</td><td>4.750 mm</td></tr> <tr><td>#10</td><td>96%</td><td>2.000 mm</td></tr> <tr><td>#20</td><td>76%</td><td>0.850 mm</td></tr> <tr><td>#40</td><td>68%</td><td>0.425 mm</td></tr> <tr><td>#100</td><td>32%</td><td>0.150 mm</td></tr> <tr><td>#200</td><td>15.5%</td><td>0.075 mm</td></tr> <tr><td><b>Silts</b></td><td>15.2%</td><td>0.074 mm</td></tr> <tr><td></td><td>10.2%</td><td>0.050 mm</td></tr> <tr><td></td><td>7.3%</td><td>0.020 mm</td></tr> <tr><td><b>Clays</b></td><td>3.0%</td><td>0.005 mm</td></tr> <tr><td></td><td>1.3%</td><td>0.002 mm</td></tr> <tr><td><b>Colloids</b></td><td>0.9%</td><td>0.001 mm</td></tr> </tbody> </table>	Sieve Size	Percent Passing	Soils Particle Diameter	3.0"	100%	75.000 mm	2.0"	100%	50.000 mm	1.5"	100%	37.500 mm	1.25"	100%	31.500 mm	1.0"	100%	25.000 mm	3/4"	100%	19.000 mm	5/8"	100%	16.000 mm	1/2"	100%	12.500 mm	3/8"	98%	9.500 mm	1/4"	98%	6.300 mm	#4	98%	4.750 mm	#10	96%	2.000 mm	#20	76%	0.850 mm	#40	68%	0.425 mm	#100	32%	0.150 mm	#200	15.5%	0.075 mm	<b>Silts</b>	15.2%	0.074 mm		10.2%	0.050 mm		7.3%	0.020 mm	<b>Clays</b>	3.0%	0.005 mm		1.3%	0.002 mm	<b>Colloids</b>	0.9%	0.001 mm
Sieve Size	Percent Passing	Soils Particle Diameter																																																																					
3.0"	100%	75.000 mm																																																																					
2.0"	100%	50.000 mm																																																																					
1.5"	100%	37.500 mm																																																																					
1.25"	100%	31.500 mm																																																																					
1.0"	100%	25.000 mm																																																																					
3/4"	100%	19.000 mm																																																																					
5/8"	100%	16.000 mm																																																																					
1/2"	100%	12.500 mm																																																																					
3/8"	98%	9.500 mm																																																																					
1/4"	98%	6.300 mm																																																																					
#4	98%	4.750 mm																																																																					
#10	96%	2.000 mm																																																																					
#20	76%	0.850 mm																																																																					
#40	68%	0.425 mm																																																																					
#100	32%	0.150 mm																																																																					
#200	15.5%	0.075 mm																																																																					
<b>Silts</b>	15.2%	0.074 mm																																																																					
	10.2%	0.050 mm																																																																					
	7.3%	0.020 mm																																																																					
<b>Clays</b>	3.0%	0.005 mm																																																																					
	1.3%	0.002 mm																																																																					
<b>Colloids</b>	0.9%	0.001 mm																																																																					
<table border="1" style="width: 100%; border-collapse: collapse;"> <thead> <tr> <th>Hydrometer Reading Minutes</th> <th>Corrected Reading</th> <th>Percent Passing</th> <th>Soils Particle Diameter</th> </tr> </thead> <tbody> <tr><td>1</td><td>7</td><td>9.1%</td><td>0.0532 mm</td></tr> <tr><td>2</td><td>7</td><td>9.1%</td><td>0.0376 mm</td></tr> <tr><td>5</td><td>6</td><td>7.8%</td><td>0.0239 mm</td></tr> <tr><td>15</td><td>5</td><td>6.5%</td><td>0.0139 mm</td></tr> <tr><td>30</td><td>4.5</td><td>5.8%</td><td>0.0098 mm</td></tr> <tr><td>60</td><td>4</td><td>5.2%</td><td>0.0070 mm</td></tr> <tr><td>240</td><td>1</td><td>1.3%</td><td>0.0035 mm</td></tr> <tr><td>1440</td><td>1</td><td>1.3%</td><td>0.0014 mm</td></tr> </tbody> </table>		Hydrometer Reading Minutes	Corrected Reading	Percent Passing	Soils Particle Diameter	1	7	9.1%	0.0532 mm	2	7	9.1%	0.0376 mm	5	6	7.8%	0.0239 mm	15	5	6.5%	0.0139 mm	30	4.5	5.8%	0.0098 mm	60	4	5.2%	0.0070 mm	240	1	1.3%	0.0035 mm	1440	1	1.3%	0.0014 mm																																		
Hydrometer Reading Minutes	Corrected Reading	Percent Passing	Soils Particle Diameter																																																																				
1	7	9.1%	0.0532 mm																																																																				
2	7	9.1%	0.0376 mm																																																																				
5	6	7.8%	0.0239 mm																																																																				
15	5	6.5%	0.0139 mm																																																																				
30	4.5	5.8%	0.0098 mm																																																																				
60	4	5.2%	0.0070 mm																																																																				
240	1	1.3%	0.0035 mm																																																																				
1440	1	1.3%	0.0014 mm																																																																				
% Gravel: 2.2% % Sand: 82.3% % Silt: 12.6% % Clay: 3.0%																																																																							
<b>USDA Soil Textural Classification</b>  <table border="1" style="width: 100%; border-collapse: collapse;"> <thead> <tr> <th></th> <th>Particle Size</th> </tr> </thead> <tbody> <tr> <td>% Sand:</td> <td>2.0 - 0.05 mm</td> </tr> <tr> <td>% Silt:</td> <td>0.05 - 0.002 mm</td> </tr> <tr> <td>% Clay:</td> <td>&lt; 0.002 mm</td> </tr> </tbody> </table>			Particle Size	% Sand:	2.0 - 0.05 mm	% Silt:	0.05 - 0.002 mm	% Clay:	< 0.002 mm																																																														
	Particle Size																																																																						
% Sand:	2.0 - 0.05 mm																																																																						
% Silt:	0.05 - 0.002 mm																																																																						
% Clay:	< 0.002 mm																																																																						
<b>USDA Soil Textural Classification</b> Sand																																																																							

All results apply only to actual locations and materials tested. As a mutual protection to clients, the public and ourselves, all reports are submitted as the confidential property of clients, and authorization for publication of statements, conclusions or extracts from or regarding our reports is reserved pending our written approval.

**Comments:** \_\_\_\_\_

\_\_\_\_\_

\_\_\_\_\_

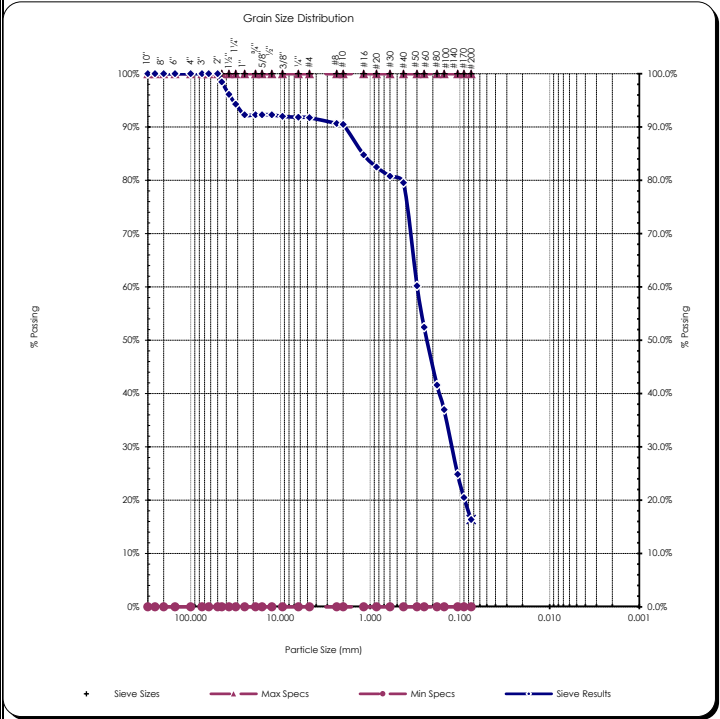
**Reviewed by:**  \_\_\_\_\_  
 Meghan Blodgett-Carrillo

# Sieve Report

<b>Project:</b> Q.C. - Lower Duwamish Waterway <b>Project #:</b> 21B233 <b>Client:</b> Anchor QEA <b>Source:</b> LDW21-GT15-GB-17.5-25.4 ft <b>Sample#:</b> B21-1792	<b>Date Received:</b> 29-Jul-21 <b>Sampled By:</b> Client <b>Date Tested:</b> 20-Sep-21 <b>Tested By:</b> C. Kriss	<b>Unified Soil Classification System, ASTM-2487</b> SM, Silty Sand <b>Sample Color:</b> brown	 <b>ACCREDITED</b> Certificate #: 1366.01
--	---	---	---

<b>ASTM D2216, ASTM D2419, ASTM D4318, ASTM D5281</b>			
<b>Specifications</b> No Specs <b>Sample Meets Specs ?</b> N/A	D <sub>(5)</sub> = 0.023 mm D <sub>(10)</sub> = 0.046 mm D <sub>(15)</sub> = 0.069 mm D <sub>(30)</sub> = 0.125 mm D <sub>(50)</sub> = 0.234 mm D <sub>(60)</sub> = 0.299 mm D <sub>(90)</sub> = 1.927 mm Dust Ratio = 7/34	% Gravel = 8.2% % Sand = 75.4% % Silt & Clay = 16.4% Liquid Limit = n/a Plasticity Index = n/a Sand Equivalent = n/a Fracture %, 1 Face = n/a Fracture %, 2+ Faces = n/a	Coeff. of Curvature, C <sub>c</sub> = 1.13 Coeff. of Uniformity, C <sub>u</sub> = 6.52 Fineness Modulus = 1.71 Plastic Limit = n/a Moisture %, as sampled = 28.3% Req'd Sand Equivalent = Req'd Fracture %, 1 Face = Req'd Fracture %, 2+ Faces =

<b>ASTM C136, ASTM D6913, ASTM C117</b>					
Sieve Size		Actual Cumulative Percent Passing	Interpolated Cumulative Percent Passing	Specs Max	Specs Min
US	Metric				
12.00"	300.00		100%	100.0%	0.0%
10.00"	250.00		100%	100.0%	0.0%
8.00"	200.00		100%	100.0%	0.0%
6.00"	150.00		100%	100.0%	0.0%
4.00"	100.00		100%	100.0%	0.0%
3.00"	75.00		100%	100.0%	0.0%
2.50"	63.00		100%	100.0%	0.0%
2.00"	50.00	100%	100%	100.0%	0.0%
1.75"	45.00		98%	100.0%	0.0%
1.50"	37.50		96%	100.0%	0.0%
1.25"	31.50		94%	100.0%	0.0%
1.00"	25.00	92%	92%	100.0%	0.0%
3/4"	19.00	92%	92%	100.0%	0.0%
5/8"	16.00		92%	100.0%	0.0%
1/2"	12.50	92%	92%	100.0%	0.0%
3/8"	9.50	92%	92%	100.0%	0.0%
1/4"	6.30		92%	100.0%	0.0%
#4	4.75	92%	92%	100.0%	0.0%
#8	2.36		91%	100.0%	0.0%
#10	2.00	91%	91%	100.0%	0.0%
#16	1.18		85%	100.0%	0.0%
#20	0.850		83%	100.0%	0.0%
#30	0.600		81%	100.0%	0.0%
#40	0.425	80%	80%	100.0%	0.0%
#50	0.300		60%	100.0%	0.0%
#60	0.250		52%	100.0%	0.0%
#80	0.180		42%	100.0%	0.0%
#100	0.150	37%	37%	100.0%	0.0%
#140	0.106		25%	100.0%	0.0%
#170	0.090		20%	100.0%	0.0%
#200	0.075	16.4%	16.4%	100.0%	0.0%



Copyright Spears Engineering & Technical Services PS, 1996-98  
 All results apply only to actual locations and materials tested. As a mutual protection to clients, the public and ourselves, all reports are submitted as the confidential property of clients, and authorization for publication of statements, conclusions or extracts from or regarding our reports is reserved pending our written approval.

**Comments:** \_\_\_\_\_

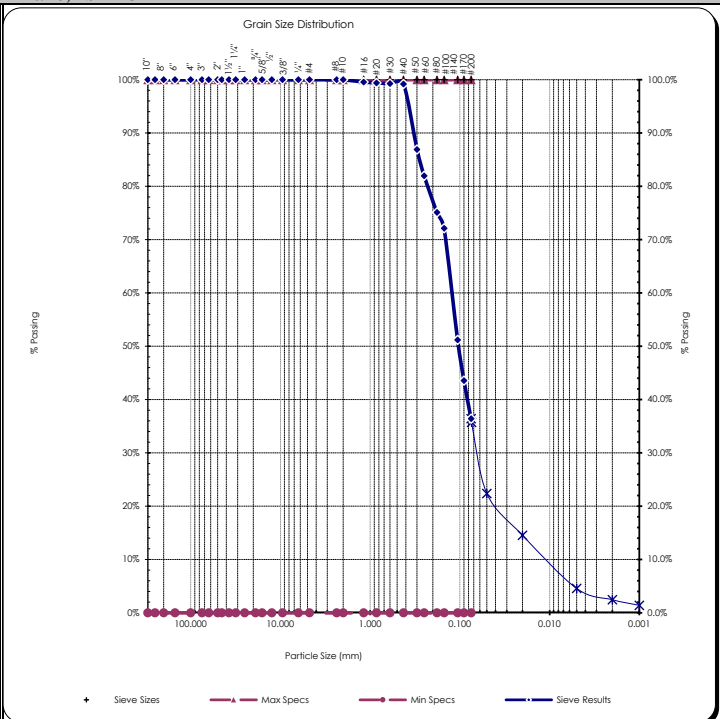
Reviewed by:   
 Meghan Blodgett-Carrillo

# Sieve Report

<b>Project:</b> Q.C. - Lower Duwamish Waterway <b>Project #:</b> 21B233 <b>Client:</b> Anchor QEA <b>Source:</b> LDW21-GT15-GB-25.4-27.5 ft <b>Sample#:</b> B21-1793	<b>Date Received:</b> 29-Jul-21 <b>Sampled By:</b> Client <b>Date Tested:</b> 20-Sep-21 <b>Tested By:</b> C. Kriss	<b>Unified Soils Classification System, ASTM D-2487</b> SM, Silty Sand <b>Sample Color:</b> brown	 Certificate #: 1366.01
--	---	--	----------------------------

<b>ASTM D2216, ASTM D2419, ASTM D4318, ASTM D5281</b>			
<b>Specifications</b> No Specs <b>Sample Meets Specs ?</b> N/A	D <sub>(5)</sub> = 0.006 mm D <sub>(10)</sub> = 0.010 mm D <sub>(15)</sub> = 0.022 mm D <sub>(30)</sub> = 0.066 mm D <sub>(50)</sub> = 0.104 mm D <sub>(60)</sub> = 0.125 mm D <sub>(90)</sub> = 0.331 mm Dust Ratio = 29/79	% Gravel = 0.0% % Sand = 63.6% % Silt & Clay = 36.4% Liquid Limit = n/a Plasticity Index = n/a Sand Equivalent = n/a Fracture %, 1 Face = n/a Fracture %, 2+ Faces = n/a	Coeff. of Curvature, C <sub>c</sub> = 3.56 Coeff. of Uniformity, C <sub>u</sub> = 12.70 Fineness Modulus = 0.42 Plastic Limit = n/a Moisture %, as sampled = 30.2% Req'd Sand Equivalent = Req'd Fracture %, 1 Face = Req'd Fracture %, 2+ Faces =

<b>ASTM C136, ASTM D6913, ASTM C117</b>					
Sieve Size		Actual Cumulative Percent Passing	Interpolated Cumulative Percent Passing	Specs Max	Specs Min
US	Metric				
12.00"	300.00		100%	100.0%	0.0%
10.00"	250.00		100%	100.0%	0.0%
8.00"	200.00		100%	100.0%	0.0%
6.00"	150.00		100%	100.0%	0.0%
4.00"	100.00		100%	100.0%	0.0%
3.00"	75.00		100%	100.0%	0.0%
2.50"	63.00		100%	100.0%	0.0%
2.00"	50.00	100%	100%	100.0%	0.0%
1.75"	45.00		100%	100.0%	0.0%
1.50"	37.50		100%	100.0%	0.0%
1.25"	31.50		100%	100.0%	0.0%
1.00"	25.00	100%	100%	100.0%	0.0%
3/4"	19.00	100%	100%	100.0%	0.0%
5/8"	16.00		100%	100.0%	0.0%
1/2"	12.50	100%	100%	100.0%	0.0%
3/8"	9.50	100%	100%	100.0%	0.0%
1/4"	6.30		100%	100.0%	0.0%
#4	4.75	100%	100%	100.0%	0.0%
#8	2.36		100%	100.0%	0.0%
#10	2.00	100%	100%	100.0%	0.0%
#16	1.18	100%	100%	100.0%	0.0%
#20	0.850	99%	99%	100.0%	0.0%
#30	0.600		99%	100.0%	0.0%
#40	0.425	99%	99%	100.0%	0.0%
#50	0.300		87%	100.0%	0.0%
#60	0.250		82%	100.0%	0.0%
#80	0.180		75%	100.0%	0.0%
#100	0.150	72%	72%	100.0%	0.0%
#140	0.106		51%	100.0%	0.0%
#170	0.090		44%	100.0%	0.0%
#200	0.075	36.4%	36.4%	100.0%	0.0%



Copyright Spears Engineering & Technical Services PS, 1996-98  
 All results apply only to actual locations and materials tested. As a mutual protection to clients, the public and ourselves, all reports are submitted as the confidential property of clients, and authorization for publication of statements, conclusions or extracts from or regarding our reports is reserved pending our written approval.

**Comments:** \_\_\_\_\_

Reviewed by:   
 Meghan Blodgett-Carrillo

## Hydrometer Report

<b>Project:</b> Q.C. - Lower Duwamish Waterway <b>Project #:</b> 21B233 <b>Client :</b> Anchor QEA <b>Source:</b> LDW21-GT15-GB-25.4-27.5 ft <b>Sample#:</b> B21-1793	<b>Date Received:</b> 29-Jul-21 <b>Sampled By:</b> Client <b>Date Tested:</b> 20-Sep-21 <b>Tested By:</b> C. Kriss	<b>Unified Soils Classification System, ASTM D-2487</b> SM, Silty Sand <b>Sample Color</b> brown																																																																																																									
<b>ASTM D7928, HYDROMETER ANALYSIS</b>		<b>ASTM D6913</b>																																																																																																									
Sp Gr : 2.46 Sample Weight: 76.16 grams Hydrosopic Moist.: 4.72% Adj. Sample Wgt : 72.73 grams																																																																																																											
<table style="width: 100%; border-collapse: collapse;"> <thead> <tr> <th style="text-align: left;">Hydrometer Reading</th> <th style="text-align: left;">Corrected Reading</th> <th style="text-align: left;">Percent Passing</th> <th style="text-align: left;">Soils Particle Diameter</th> </tr> </thead> <tbody> <tr><td>1</td><td>15</td><td>21.7%</td><td>0.0541 mm</td></tr> <tr><td>2</td><td>13.5</td><td>19.5%</td><td>0.0388 mm</td></tr> <tr><td>5</td><td>11</td><td>15.9%</td><td>0.0248 mm</td></tr> <tr><td>15</td><td>9</td><td>13.0%</td><td>0.0145 mm</td></tr> <tr><td>30</td><td>7.5</td><td>10.8%</td><td>0.0104 mm</td></tr> <tr><td>60</td><td>4.5</td><td>6.5%</td><td>0.0074 mm</td></tr> <tr><td>240</td><td>2.5</td><td>3.6%</td><td>0.0038 mm</td></tr> <tr><td>1440</td><td>1.5</td><td>2.2%</td><td>0.0015 mm</td></tr> </tbody> </table>		Hydrometer Reading	Corrected Reading	Percent Passing	Soils Particle Diameter	1	15	21.7%	0.0541 mm	2	13.5	19.5%	0.0388 mm	5	11	15.9%	0.0248 mm	15	9	13.0%	0.0145 mm	30	7.5	10.8%	0.0104 mm	60	4.5	6.5%	0.0074 mm	240	2.5	3.6%	0.0038 mm	1440	1.5	2.2%	0.0015 mm	<table style="width: 100%; border-collapse: collapse;"> <thead> <tr> <th style="text-align: left;">Sieve Size</th> <th style="text-align: left;">Percent Passing</th> <th style="text-align: left;">Soils Particle Diameter</th> </tr> </thead> <tbody> <tr><td>3.0"</td><td>100%</td><td>75.000 mm</td></tr> <tr><td>2.0"</td><td>100%</td><td>50.000 mm</td></tr> <tr><td>1.5"</td><td>100%</td><td>37.500 mm</td></tr> <tr><td>1.25"</td><td>100%</td><td>31.500 mm</td></tr> <tr><td>1.0"</td><td>100%</td><td>25.000 mm</td></tr> <tr><td>3/4"</td><td>100%</td><td>19.000 mm</td></tr> <tr><td>5/8"</td><td>100%</td><td>16.000 mm</td></tr> <tr><td>1/2"</td><td>100%</td><td>12.500 mm</td></tr> <tr><td>3/8"</td><td>100%</td><td>9.500 mm</td></tr> <tr><td>1/4"</td><td>100%</td><td>6.300 mm</td></tr> <tr><td>#4</td><td>100%</td><td>4.750 mm</td></tr> <tr><td>#10</td><td>100%</td><td>2.000 mm</td></tr> <tr><td>#20</td><td>99%</td><td>0.850 mm</td></tr> <tr><td>#40</td><td>99%</td><td>0.425 mm</td></tr> <tr><td>#100</td><td>72%</td><td>0.150 mm</td></tr> <tr><td>#200</td><td>36.4%</td><td>0.075 mm</td></tr> <tr><td><b>Silts</b></td><td>35.7%</td><td>0.074 mm</td></tr> <tr><td></td><td>22.4%</td><td>0.050 mm</td></tr> <tr><td></td><td>14.5%</td><td>0.020 mm</td></tr> <tr><td><b>Clays</b></td><td>4.6%</td><td>0.005 mm</td></tr> <tr><td></td><td>2.5%</td><td>0.002 mm</td></tr> <tr><td><b>Colloids</b></td><td>1.4%</td><td>0.001 mm</td></tr> </tbody> </table>	Sieve Size	Percent Passing	Soils Particle Diameter	3.0"	100%	75.000 mm	2.0"	100%	50.000 mm	1.5"	100%	37.500 mm	1.25"	100%	31.500 mm	1.0"	100%	25.000 mm	3/4"	100%	19.000 mm	5/8"	100%	16.000 mm	1/2"	100%	12.500 mm	3/8"	100%	9.500 mm	1/4"	100%	6.300 mm	#4	100%	4.750 mm	#10	100%	2.000 mm	#20	99%	0.850 mm	#40	99%	0.425 mm	#100	72%	0.150 mm	#200	36.4%	0.075 mm	<b>Silts</b>	35.7%	0.074 mm		22.4%	0.050 mm		14.5%	0.020 mm	<b>Clays</b>	4.6%	0.005 mm		2.5%	0.002 mm	<b>Colloids</b>	1.4%	0.001 mm
Hydrometer Reading	Corrected Reading	Percent Passing	Soils Particle Diameter																																																																																																								
1	15	21.7%	0.0541 mm																																																																																																								
2	13.5	19.5%	0.0388 mm																																																																																																								
5	11	15.9%	0.0248 mm																																																																																																								
15	9	13.0%	0.0145 mm																																																																																																								
30	7.5	10.8%	0.0104 mm																																																																																																								
60	4.5	6.5%	0.0074 mm																																																																																																								
240	2.5	3.6%	0.0038 mm																																																																																																								
1440	1.5	2.2%	0.0015 mm																																																																																																								
Sieve Size	Percent Passing	Soils Particle Diameter																																																																																																									
3.0"	100%	75.000 mm																																																																																																									
2.0"	100%	50.000 mm																																																																																																									
1.5"	100%	37.500 mm																																																																																																									
1.25"	100%	31.500 mm																																																																																																									
1.0"	100%	25.000 mm																																																																																																									
3/4"	100%	19.000 mm																																																																																																									
5/8"	100%	16.000 mm																																																																																																									
1/2"	100%	12.500 mm																																																																																																									
3/8"	100%	9.500 mm																																																																																																									
1/4"	100%	6.300 mm																																																																																																									
#4	100%	4.750 mm																																																																																																									
#10	100%	2.000 mm																																																																																																									
#20	99%	0.850 mm																																																																																																									
#40	99%	0.425 mm																																																																																																									
#100	72%	0.150 mm																																																																																																									
#200	36.4%	0.075 mm																																																																																																									
<b>Silts</b>	35.7%	0.074 mm																																																																																																									
	22.4%	0.050 mm																																																																																																									
	14.5%	0.020 mm																																																																																																									
<b>Clays</b>	4.6%	0.005 mm																																																																																																									
	2.5%	0.002 mm																																																																																																									
<b>Colloids</b>	1.4%	0.001 mm																																																																																																									
<b>USDA Soil Textural Classification</b>																																																																																																											
<table style="width: 100%; border-collapse: collapse;"> <thead> <tr> <th style="text-align: left;">Particle Size</th> <th style="text-align: left;">% Sand:</th> <th style="text-align: left;">% Silt:</th> <th style="text-align: left;">% Clay:</th> </tr> </thead> <tbody> <tr> <td>2.0 - 0.05 mm</td> <td>63.6%</td> <td>31.8%</td> <td>4.6%</td> </tr> <tr> <td>0.05 - 0.002 mm</td> <td></td> <td></td> <td></td> </tr> <tr> <td>&lt; 0.002 mm</td> <td></td> <td></td> <td></td> </tr> </tbody> </table>		Particle Size	% Sand:	% Silt:	% Clay:	2.0 - 0.05 mm	63.6%	31.8%	4.6%	0.05 - 0.002 mm				< 0.002 mm																																																																																													
Particle Size	% Sand:	% Silt:	% Clay:																																																																																																								
2.0 - 0.05 mm	63.6%	31.8%	4.6%																																																																																																								
0.05 - 0.002 mm																																																																																																											
< 0.002 mm																																																																																																											
<b>USDA Soil Textural Classification</b>																																																																																																											
Loamy Sand																																																																																																											

All results apply only to actual locations and materials tested. As a mutual protection to clients, the public and ourselves, all reports are submitted as the confidential property of clients, and authorization for publication of statements, conclusions or extracts from or regarding our reports is reserved pending our written approval.

**Comments:** \_\_\_\_\_

\_\_\_\_\_

\_\_\_\_\_

**Reviewed by:** \_\_\_\_\_  
 Meghan Blodgett-Carrillo



# Materials Testing & Consulting, Inc.

Geotechnical Engineering • Special Inspections • Materials Testing • Environmental Consulting



## ASTM D4318 - Liquid Limit, Plastic Limit and Plasticity Index of Soils

<b>Project:</b> Q.C. - Lower Duwamish Waterway <b>Project #:</b> 21B233 <b>Client:</b> Anchor QEA <b>Source:</b> LDW21-GT29-0-10.6 ft <b>Sample #:</b> B21-1796	<b>Date Received:</b> 29-Jul-21 <b>Sampled By:</b> Client <b>Date Tested:</b> 21-Sep-21 <b>Tested By:</b> C. Kriss	<b>Visual Identification</b> Silt <b>Sample Color</b> brown
---	---	--

Liquid Limit Determination						
	#1	#2	#3	#4	#5	#6
Weight of Wet Soils + Pan:	32.74	33.79	36.07			
Weight of Dry Soils + Pan:	28.61	29.18	30.52			
Weight of Pan:	19.91	19.73	19.61			
Weight of Dry Soils:	8.70	9.45	10.91			
Weight of Moisture:	4.13	4.61	5.55			
% Moisture:	47.5 %	48.8 %	50.9 %			
Number of Blows:	25	16	11			


Plastic Limit Determination						
	#1	#2	#3	#4	#5	#6
Weight of Wet Soils + Pan:						
Weight of Dry Soils + Pan:	Plastic limit cannot be determined					
Weight of Pan:						
Weight of Dry Soils:						
Weight of Moisture:						
% Moisture:						

**Liquid Limit @ 25 Blows:** 47 %

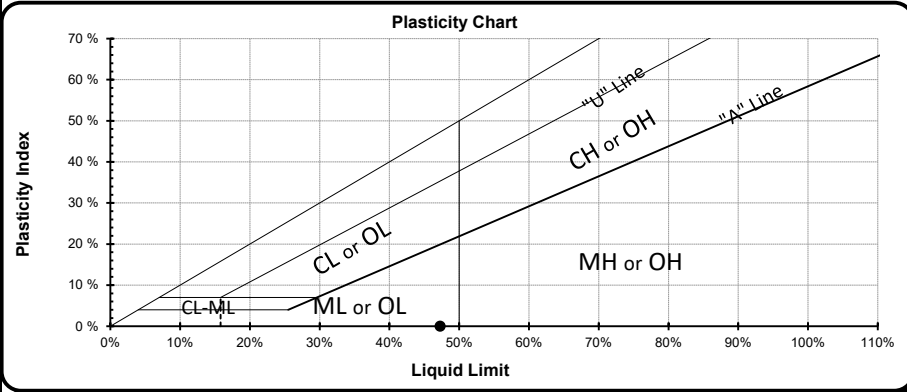
**Plastic Limit:** N/A

**Plasticity Index, I<sub>p</sub>:** N/A

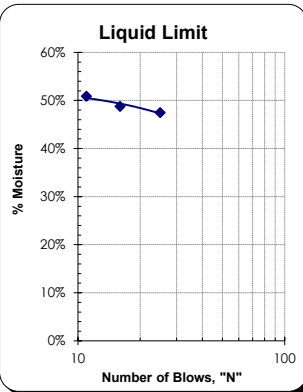


ACCREDITED  
Certificate #: 1366.01, 1366.02 & 1366.04



Copyright Spears Engineering & Technical Services PS, 1996-98



All results apply only to actual locations and materials tested. As a mutual protection to clients, the public and ourselves, all reports are submitted as the confidential property of clients, and authorization for publication of statements, conclusions or extracts from or regarding our reports is reserved pending our written approval.

**Comments:** Plastic limit cannot be determined as the material does not roll down to 1/8" threads before cracking or crumbling. Non-plastic.

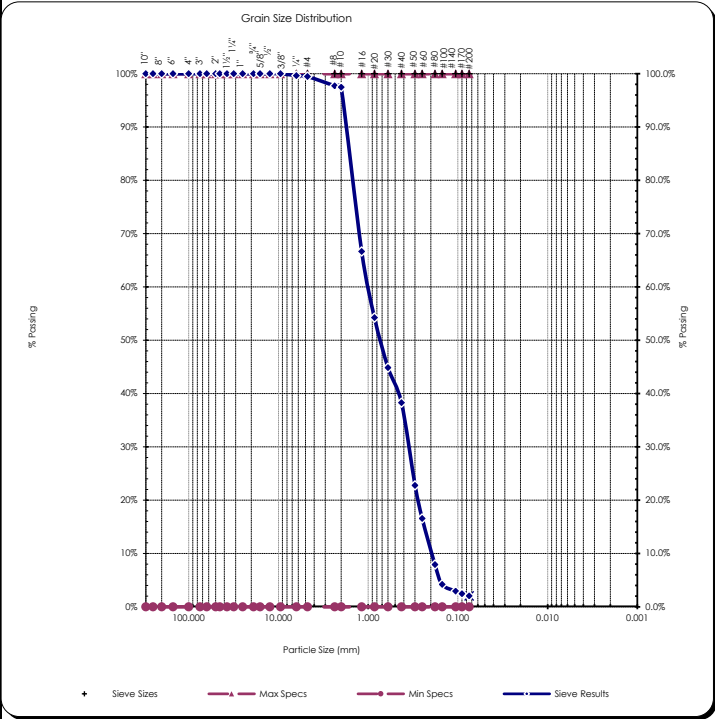
Reviewed by:   
 Meghan Blodgett-Carrillo

# Sieve Report

<b>Project:</b> Q.C. - Lower Duwamish Waterway <b>Project #:</b> 21B233 <b>Client:</b> Anchor QEA <b>Source:</b> LDW21-GT29-GB-11-21 ft <b>Sample#:</b> B21-1798	<b>Date Received:</b> 29-Jul-21 <b>Sampled By:</b> Client <b>Date Tested:</b> 20-Sep-21 <b>Tested By:</b> C. Kriss	<b>Unified Soil Classification System, ASTM-2487</b> SP, Poorly graded Sand <b>Sample Color:</b> brown	 <b>ACCREDITED</b> Certificate #: 1366.01
--	---	---	---

<b>ASTM D2216, ASTM D2419, ASTM D4318, ASTM D5281</b>			
<b>Specifications</b> No Specs <b>Sample Meets Specs ?</b> N/A	D <sub>(5)</sub> = 0.156 mm D <sub>(10)</sub> = 0.197 mm D <sub>(15)</sub> = 0.237 mm D <sub>(30)</sub> = 0.358 mm D <sub>(50)</sub> = 0.737 mm D <sub>(60)</sub> = 1.003 mm D <sub>(90)</sub> = 1.801 mm Dust Ratio = 3/56	% Gravel = 0.5% % Sand = 97.4% % Silt & Clay = 2.0% Liquid Limit = n/a Plasticity Index = n/a Sand Equivalent = n/a Fracture %, 1 Face = n/a Fracture %, 2+ Faces = n/a	Coeff. of Curvature, C <sub>c</sub> = 0.65 Coeff. of Uniformity, C <sub>u</sub> = 5.10 Fineness Modulus = 2.64 Plastic Limit = n/a Moisture %, as sampled = 21.6% Req'd Sand Equivalent = Req'd Fracture %, 1 Face = Req'd Fracture %, 2+ Faces =

<b>ASTM C136, ASTM D6913, ASTM C117</b>					
Sieve Size		Actual Cumulative Percent Passing	Interpolated Cumulative Percent Passing	Specs Max	Specs Min
US	Metric				
12.00"	300.00		100%	100.0%	0.0%
10.00"	250.00		100%	100.0%	0.0%
8.00"	200.00		100%	100.0%	0.0%
6.00"	150.00		100%	100.0%	0.0%
4.00"	100.00		100%	100.0%	0.0%
3.00"	75.00		100%	100.0%	0.0%
2.50"	63.00		100%	100.0%	0.0%
2.00"	50.00	100%	100%	100.0%	0.0%
1.75"	45.00	100%	100%	100.0%	0.0%
1.50"	37.50	100%	100%	100.0%	0.0%
1.25"	31.50	100%	100%	100.0%	0.0%
1.00"	25.00	100%	100%	100.0%	0.0%
3/4"	19.00	100%	100%	100.0%	0.0%
5/8"	16.00	100%	100%	100.0%	0.0%
1/2"	12.50	100%	100%	100.0%	0.0%
3/8"	9.50	100%	100%	100.0%	0.0%
1/4"	6.30	100%	100%	100.0%	0.0%
#4	4.75	99%	99%	100.0%	0.0%
#8	2.36		98%	100.0%	0.0%
#10	2.00	97%	97%	100.0%	0.0%
#16	1.18		67%	100.0%	0.0%
#20	0.850		54%	100.0%	0.0%
#30	0.600		45%	100.0%	0.0%
#40	0.425	38%	38%	100.0%	0.0%
#50	0.300		23%	100.0%	0.0%
#60	0.250		17%	100.0%	0.0%
#80	0.180		8%	100.0%	0.0%
#100	0.150	4%	4%	100.0%	0.0%
#140	0.106		3%	100.0%	0.0%
#170	0.090		2%	100.0%	0.0%
#200	0.075	2.0%	2.0%	100.0%	0.0%



Copyright Spears Engineering & Technical Services PS, 1996-98

All results apply only to actual locations and materials tested. As a mutual protection to clients, the public and ourselves, all reports are submitted as the confidential property of clients, and authorization for publication of statements, conclusions or extracts from or regarding our reports is reserved pending our written approval.

**Comments:** \_\_\_\_\_

Reviewed by:   
 Meghan Blodgett-Carrillo



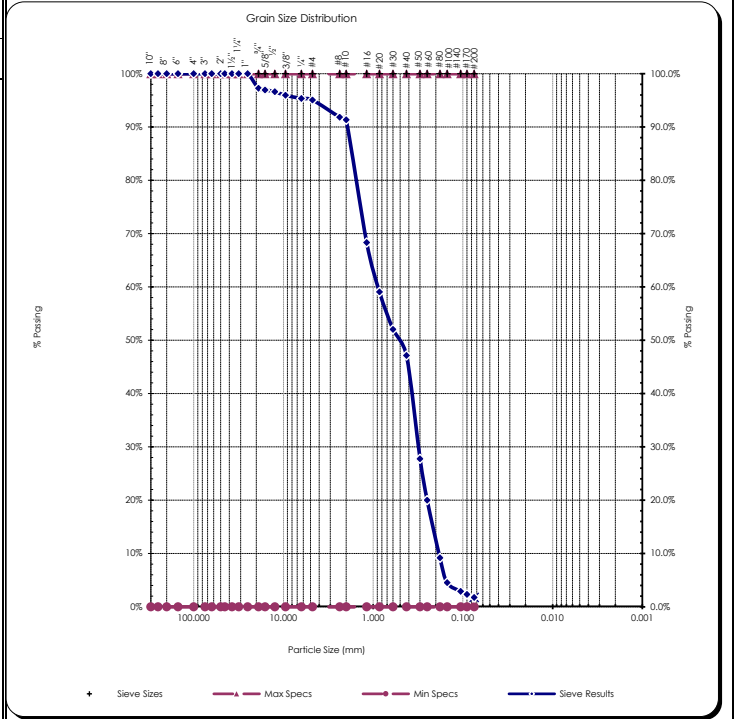
# Sieve Report

<b>Project:</b> Q.C. - Lower Duwamish Waterway <b>Project #:</b> 21B233 <b>Client:</b> Anchor QEA <b>Source:</b> LDW21-GT29-GB-21-26 ft <b>Sample#:</b> B21-1800	<b>Date Received:</b> 29-Jul-21 <b>Sampled By:</b> Client <b>Date Tested:</b> 20-Sep-21 <b>Tested By:</b> C. Kriss	<b>Unified Soil Classification System, ASTM-2487</b> SP, Poorly graded Sand <b>Sample Color:</b> gray	 Certificate #: 1366.01
--	---	--	----------------------------

<b>ASTM D2216, ASTM D2419, ASTM D4318, ASTM D5281</b>			
<b>Specifications</b> No Specs <b>Sample Meets Specs ? N/A</b>	D <sub>(5)</sub> = 0.153 mm D <sub>(10)</sub> = 0.185 mm D <sub>(15)</sub> = 0.218 mm D <sub>(30)</sub> = 0.314 mm D <sub>(50)</sub> = 0.527 mm D <sub>(60)</sub> = 0.883 mm D <sub>(90)</sub> = 1.952 mm Dust Ratio = 3/80	% Gravel = 4.9% % Sand = 93.3% % Silt & Clay = 1.8% Liquid Limit = n/a Plasticity Index = n/a Sand Equivalent = n/a Fracture %, 1 Face = n/a Fracture %, 2+ Faces = n/a	Coeff. of Curvature, C <sub>c</sub> = 0.60 Coeff. of Uniformity, C <sub>u</sub> = 4.77 Fineness Modulus = 2.67 Plastic Limit = n/a Moisture %, as sampled = 18.8% Req'd Sand Equivalent = Req'd Fracture %, 1 Face = Req'd Fracture %, 2+ Faces =

**ASTM C136, ASTM D6913, ASTM C117**

Sieve Size		Actual Cumulative Percent Passing	Interpolated Cumulative Percent Passing	Specs Max	Specs Min
US	Metric				
12.00"	300.00		100%	100.0%	0.0%
10.00"	250.00		100%	100.0%	0.0%
8.00"	200.00		100%	100.0%	0.0%
6.00"	150.00		100%	100.0%	0.0%
4.00"	100.00		100%	100.0%	0.0%
3.00"	75.00		100%	100.0%	0.0%
2.50"	63.00		100%	100.0%	0.0%
2.00"	50.00	100%	100%	100.0%	0.0%
1.75"	45.00		100%	100.0%	0.0%
1.50"	37.50		100%	100.0%	0.0%
1.25"	31.50		100%	100.0%	0.0%
1.00"	25.00	100%	100%	100.0%	0.0%
3/4"	19.00	97%	97%	100.0%	0.0%
5/8"	16.00		97%	100.0%	0.0%
1/2"	12.50	97%	97%	100.0%	0.0%
3/8"	9.50	96%	96%	100.0%	0.0%
1/4"	6.30		95%	100.0%	0.0%
#4	4.75	95%	95%	100.0%	0.0%
#8	2.36		92%	100.0%	0.0%
#10	2.00	91%	91%	100.0%	0.0%
#16	1.18		68%	100.0%	0.0%
#20	0.850		59%	100.0%	0.0%
#30	0.600		52%	100.0%	0.0%
#40	0.425	47%	47%	100.0%	0.0%
#50	0.300		28%	100.0%	0.0%
#60	0.250		20%	100.0%	0.0%
#80	0.180		9%	100.0%	0.0%
#100	0.150	5%	5%	100.0%	0.0%
#140	0.106		3%	100.0%	0.0%
#170	0.090		2%	100.0%	0.0%
#200	0.075	1.8%	1.8%	100.0%	0.0%



Copyright Spears Engineering & Technical Services PS, 1996-98  
 All results apply only to actual locations and materials tested. As a mutual protection to clients, the public and ourselves, all reports are submitted as the confidential property of clients, and authorization for publication of statements, conclusions or extracts from or regarding our reports is reserved pending our written approval.

**Comments:** \_\_\_\_\_

Reviewed by:   
 Meghan Blodgett-Carrillo

# Direct Shear Test Results:

ASTM D-3080



Project: Q.C. - Lower Duwamish Waterway  
 Project Number: 21B233  
 Laboratory Sample ID: B21-1800  
 Sample Date: 7/14/2021  
 Test Date: 9/29/2021  
 Technician: M. Carrillo

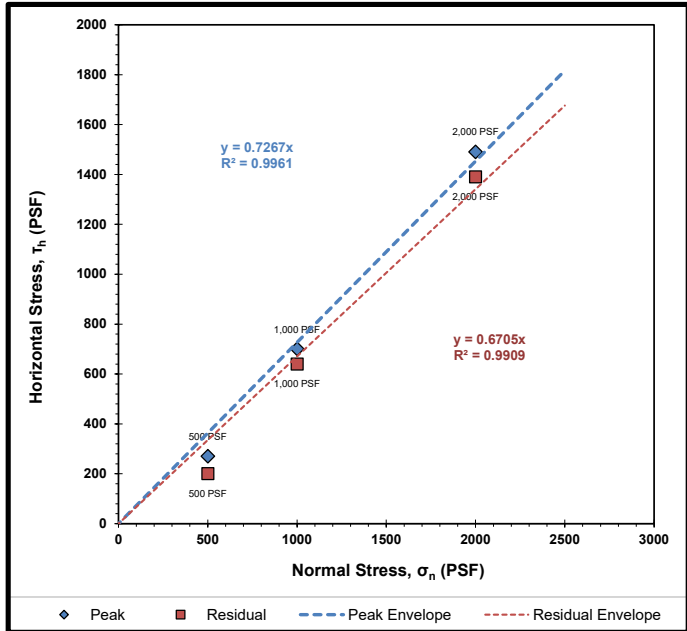
Sample Source: LDW21-GT29-GB-21-26 ft  
 Visual Soil Description: gray sand  
 Type of Specimen: Remolded Cylindrical Shear Box  
 Specimen Diameter (in): 2.5  
 Specimen Height (in): 1  
 Rate of Strain (in/min): 0.0208  
 Estimated Specific Gravity of Solids: 2.65

Summary of Sample Data: $\sigma_n=500$ PSF		
Initial Moisture Content (%)	23.0	
	Initial	Post-Consolidation
Dry Density (PCF):	107.5	108.1
Void Ratio:	0.567	0.558
Porosity (%):	36.2	35.8
Degree of Saturation (%):	saturated	saturated

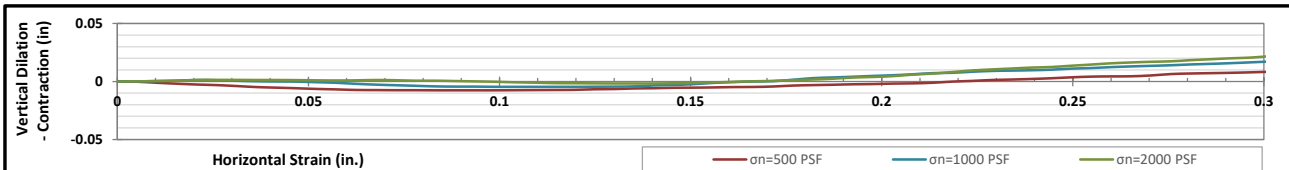
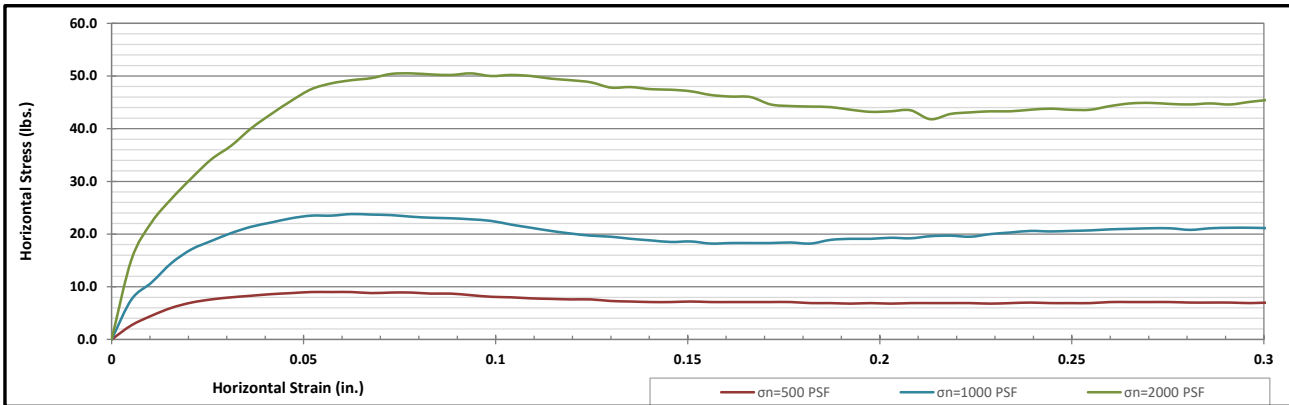
Summary of Sample Data: $\sigma_n=1000$ PSF		
Initial Moisture Content (%)	22.3	
	Initial	Post-Consolidation
Dry Density (PCF):	107.1	108.5
Void Ratio:	0.572	0.552
Porosity (%):	36.4	35.6
Degree of Saturation (%):	saturated	saturated

Summary of Sample Data: $\sigma_n=2000$ PSF		
Initial Moisture Content (%)	21.8	
	Initial	Post-Consolidation
Dry Density (PCF):	108.8	110.9
Void Ratio:	0.548	0.519
Porosity (%):	35.4	34.2
Degree of Saturation (%):	saturated	saturated

ESTIMATED STRENGTH PARAMETERS		
	PEAK	RESIDUAL
Angle of Internal Friction, $\phi$ (°):	36	34
Cohesion (PSF):	0	0



Failure Envelope Test Values:			
Normal Stress, $\sigma_n$ (PSF):	500	1000	2000
Peak Horizontal Stress, $\tau_h$ (PSF):	270	700	1490
Residual Horizontal Stress, $\tau_r$ (PSF):	200	640	1390



Corporate • 777 Chrysler Drive • Burlington, WA 98233 • Phone 360.755.1990 • Fax 360.755.1980  
 SW Region • 2118 Black Lake Blvd. S.W. • Olympia, WA 98512 • Phone 360.534.9777 • Fax 360.534.9779  
 NW Region • 805 Dupont, Suite #5 • Bellingham, WA 98225 • Phone 360.647.6061 • Fax 360.647.8111  
 Kitsap Region • 5451 N.W. Newberry Hill Road, Suite 101 • Silverdale, WA 98383 • Phone/Fax 360.698.6787

Visit our website: [www.mtc-inc.net](http://www.mtc-inc.net)

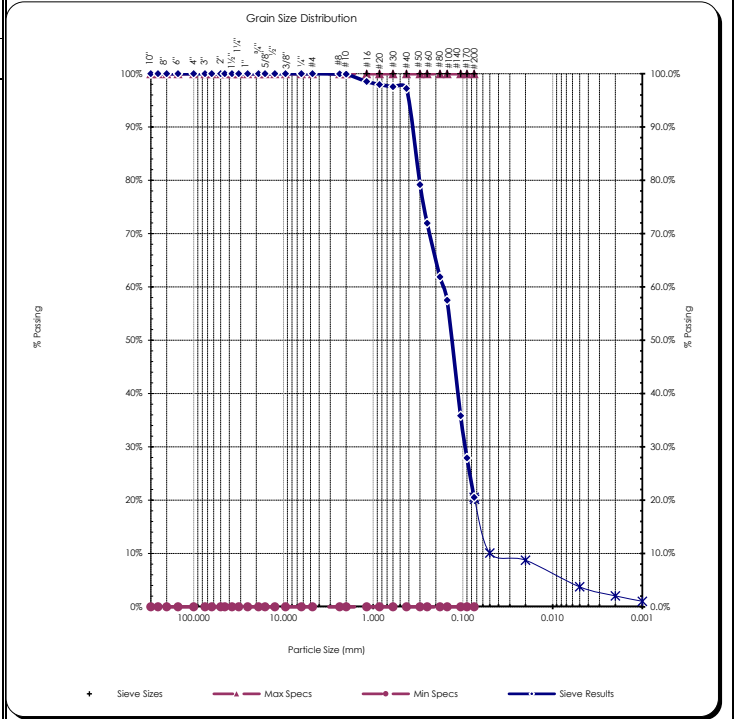
# Sieve Report

<b>Project:</b> Q.C. - Lower Duwamish Waterway <b>Project #:</b> 21B233 <b>Client:</b> Anchor QEA <b>Source:</b> LDW21-GT29-GB-26-28.9 ft <b>Sample#:</b> B21-1801	<b>Date Received:</b> 29-Jul-21 <b>Sampled By:</b> Client <b>Date Tested:</b> 20-Sep-21 <b>Tested By:</b> C. Kriss	<b>Unified Soils Classification System, ASTM D-2487</b> SM, Silty Sand <b>Sample Color:</b> brown	 <b>ACCREDITED</b> Certificate #: 1366.01
--	---	--	---

<b>ASTM D2216, ASTM D2419, ASTM D4318, ASTM D5281</b>			
<b>Specifications</b> No Specs <b>Sample Meets Specs ? N/A</b>	D <sub>(5)</sub> = 0.008 mm D <sub>(10)</sub> = 0.040 mm D <sub>(15)</sub> = 0.061 mm D <sub>(30)</sub> = 0.094 mm D <sub>(50)</sub> = 0.135 mm D <sub>(60)</sub> = 0.167 mm D <sub>(90)</sub> = 0.375 mm Dust Ratio = 15/71	% Gravel = 0.0% % Sand = 79.4% % Silt & Clay = 20.6% Liquid Limit = n/a Plasticity Index = n/a Sand Equivalent = n/a Fracture %, 1 Face = n/a Fracture %, 2+ Faces = n/a	Coeff. of Curvature, C <sub>c</sub> = 1.33 Coeff. of Uniformity, C <sub>u</sub> = 4.18 Fineness Modulus = 0.67 Plastic Limit = n/a Moisture %, as sampled = 36.9% Req'd Sand Equivalent = Req'd Fracture %, 1 Face = Req'd Fracture %, 2+ Faces =

**ASTM C136, ASTM D6913, ASTM C117**

Sieve Size		Actual Cumulative Percent Passing	Interpolated Cumulative Percent Passing	Specs Max	Specs Min
US	Metric				
12.00"	300.00		100%	100.0%	0.0%
10.00"	250.00		100%	100.0%	0.0%
8.00"	200.00		100%	100.0%	0.0%
6.00"	150.00		100%	100.0%	0.0%
4.00"	100.00		100%	100.0%	0.0%
3.00"	75.00		100%	100.0%	0.0%
2.50"	63.00		100%	100.0%	0.0%
2.00"	50.00	100%	100%	100.0%	0.0%
1.75"	45.00		100%	100.0%	0.0%
1.50"	37.50		100%	100.0%	0.0%
1.25"	31.50		100%	100.0%	0.0%
1.00"	25.00	100%	100%	100.0%	0.0%
3/4"	19.00	100%	100%	100.0%	0.0%
5/8"	16.00		100%	100.0%	0.0%
1/2"	12.50	100%	100%	100.0%	0.0%
3/8"	9.50	100%	100%	100.0%	0.0%
1/4"	6.30		100%	100.0%	0.0%
#4	4.75	100%	100%	100.0%	0.0%
#8	2.36		100%	100.0%	0.0%
#10	2.00	100%	100%	100.0%	0.0%
#16	1.18		99%	100.0%	0.0%
#20	0.850		98%	100.0%	0.0%
#30	0.600		98%	100.0%	0.0%
#40	0.425	97%	97%	100.0%	0.0%
#50	0.300		79%	100.0%	0.0%
#60	0.250		72%	100.0%	0.0%
#80	0.180		62%	100.0%	0.0%
#100	0.150	58%	58%	100.0%	0.0%
#140	0.106		36%	100.0%	0.0%
#170	0.090		28%	100.0%	0.0%
#200	0.075	20.6%	20.6%	100.0%	0.0%




Copyright Spears Engineering & Technical Services PS, 1996-98  
 All results apply only to actual locations and materials tested. As a mutual protection to clients, the public and ourselves, all reports are submitted as the confidential property of clients, and authorization for publication of statements, conclusions or extracts from or regarding our reports is reserved pending our written approval.

**Comments:** \_\_\_\_\_

Reviewed by:   
 Meghan Blodgett-Carrillo

## Hydrometer Report

<b>Project:</b> Q.C. - Lower Duwamish Waterway <b>Project #:</b> 21B233 <b>Client :</b> Anchor QEA <b>Source:</b> LDW21-GT29-GB-26-28.9 ft <b>Sample#:</b> B21-1801	<b>Date Received:</b> 29-Jul-21 <b>Sampled By:</b> Client <b>Date Tested:</b> 20-Sep-21 <b>Tested By:</b> C. Kriss	<b>Unified Soils Classification System, ASTM D-2487</b> SM, Silty Sand <b>Sample Color</b> brown																																																																					
<b>ASTM D7928, HYDROMETER ANALYSIS</b>		<b>ASTM D6913</b>																																																																					
Assumed Sp Gr : 2.65 Sample Weight: 100.10 grams Hydrosopic Moist.: 1.34% Adj. Sample Wgt : 98.78 grams		Sieve Analysis <b>Grain Size Distribution</b>																																																																					
		<table border="1" style="width: 100%; border-collapse: collapse;"> <thead> <tr> <th>Sieve Size</th> <th>Percent Passing</th> <th>Soils Particle Diameter</th> </tr> </thead> <tbody> <tr><td>3.0"</td><td>100%</td><td>75.000 mm</td></tr> <tr><td>2.0"</td><td>100%</td><td>50.000 mm</td></tr> <tr><td>1.5"</td><td>100%</td><td>37.500 mm</td></tr> <tr><td>1.25"</td><td>100%</td><td>31.500 mm</td></tr> <tr><td>1.0"</td><td>100%</td><td>25.000 mm</td></tr> <tr><td>3/4"</td><td>100%</td><td>19.000 mm</td></tr> <tr><td>5/8"</td><td>100%</td><td>16.000 mm</td></tr> <tr><td>1/2"</td><td>100%</td><td>12.500 mm</td></tr> <tr><td>3/8"</td><td>100%</td><td>9.500 mm</td></tr> <tr><td>1/4"</td><td>100%</td><td>6.300 mm</td></tr> <tr><td>#4</td><td>100%</td><td>4.750 mm</td></tr> <tr><td>#10</td><td>100%</td><td>2.000 mm</td></tr> <tr><td>#20</td><td>98%</td><td>0.850 mm</td></tr> <tr><td>#40</td><td>97%</td><td>0.425 mm</td></tr> <tr><td>#100</td><td>58%</td><td>0.150 mm</td></tr> <tr><td>#200</td><td>20.6%</td><td>0.075 mm</td></tr> <tr><td><b>Silts</b></td><td>20.2%</td><td>0.074 mm</td></tr> <tr><td></td><td>10.1%</td><td>0.050 mm</td></tr> <tr><td></td><td>8.7%</td><td>0.020 mm</td></tr> <tr><td><b>Clays</b></td><td>3.8%</td><td>0.005 mm</td></tr> <tr><td></td><td>2.1%</td><td>0.002 mm</td></tr> <tr><td><b>Colloids</b></td><td>1.1%</td><td>0.001 mm</td></tr> </tbody> </table>	Sieve Size	Percent Passing	Soils Particle Diameter	3.0"	100%	75.000 mm	2.0"	100%	50.000 mm	1.5"	100%	37.500 mm	1.25"	100%	31.500 mm	1.0"	100%	25.000 mm	3/4"	100%	19.000 mm	5/8"	100%	16.000 mm	1/2"	100%	12.500 mm	3/8"	100%	9.500 mm	1/4"	100%	6.300 mm	#4	100%	4.750 mm	#10	100%	2.000 mm	#20	98%	0.850 mm	#40	97%	0.425 mm	#100	58%	0.150 mm	#200	20.6%	0.075 mm	<b>Silts</b>	20.2%	0.074 mm		10.1%	0.050 mm		8.7%	0.020 mm	<b>Clays</b>	3.8%	0.005 mm		2.1%	0.002 mm	<b>Colloids</b>	1.1%	0.001 mm
Sieve Size	Percent Passing	Soils Particle Diameter																																																																					
3.0"	100%	75.000 mm																																																																					
2.0"	100%	50.000 mm																																																																					
1.5"	100%	37.500 mm																																																																					
1.25"	100%	31.500 mm																																																																					
1.0"	100%	25.000 mm																																																																					
3/4"	100%	19.000 mm																																																																					
5/8"	100%	16.000 mm																																																																					
1/2"	100%	12.500 mm																																																																					
3/8"	100%	9.500 mm																																																																					
1/4"	100%	6.300 mm																																																																					
#4	100%	4.750 mm																																																																					
#10	100%	2.000 mm																																																																					
#20	98%	0.850 mm																																																																					
#40	97%	0.425 mm																																																																					
#100	58%	0.150 mm																																																																					
#200	20.6%	0.075 mm																																																																					
<b>Silts</b>	20.2%	0.074 mm																																																																					
	10.1%	0.050 mm																																																																					
	8.7%	0.020 mm																																																																					
<b>Clays</b>	3.8%	0.005 mm																																																																					
	2.1%	0.002 mm																																																																					
<b>Colloids</b>	1.1%	0.001 mm																																																																					
<table border="1" style="width: 100%; border-collapse: collapse;"> <thead> <tr> <th>Hydrometer Reading Minutes</th> <th>Corrected Reading</th> <th>Percent Passing</th> <th>Soils Particle Diameter</th> </tr> </thead> <tbody> <tr><td>1</td><td>11.5</td><td>11.6%</td><td>0.0520 mm</td></tr> <tr><td>2</td><td>9.5</td><td>9.6%</td><td>0.0371 mm</td></tr> <tr><td>5</td><td>9</td><td>9.1%</td><td>0.0235 mm</td></tr> <tr><td>15</td><td>8</td><td>8.1%</td><td>0.0137 mm</td></tr> <tr><td>30</td><td>6</td><td>6.1%</td><td>0.0097 mm</td></tr> <tr><td>60</td><td>4</td><td>4.0%</td><td>0.0070 mm</td></tr> <tr><td>240</td><td>3.5</td><td>3.5%</td><td>0.0035 mm</td></tr> <tr><td>1440</td><td>1.5</td><td>1.5%</td><td>0.0014 mm</td></tr> </tbody> </table>		Hydrometer Reading Minutes	Corrected Reading	Percent Passing	Soils Particle Diameter	1	11.5	11.6%	0.0520 mm	2	9.5	9.6%	0.0371 mm	5	9	9.1%	0.0235 mm	15	8	8.1%	0.0137 mm	30	6	6.1%	0.0097 mm	60	4	4.0%	0.0070 mm	240	3.5	3.5%	0.0035 mm	1440	1.5	1.5%	0.0014 mm																																		
Hydrometer Reading Minutes	Corrected Reading	Percent Passing	Soils Particle Diameter																																																																				
1	11.5	11.6%	0.0520 mm																																																																				
2	9.5	9.6%	0.0371 mm																																																																				
5	9	9.1%	0.0235 mm																																																																				
15	8	8.1%	0.0137 mm																																																																				
30	6	6.1%	0.0097 mm																																																																				
60	4	4.0%	0.0070 mm																																																																				
240	3.5	3.5%	0.0035 mm																																																																				
1440	1.5	1.5%	0.0014 mm																																																																				
% Gravel: 0.0% % Sand: 79.4% % Silt: 16.8% % Clay: 3.8%																																																																							
<b>USDA Soil Textural Classification</b>  <table border="1" style="width: 100%; border-collapse: collapse;"> <thead> <tr> <th></th> <th>Particle Size</th> </tr> </thead> <tbody> <tr> <td>% Sand:</td> <td>2.0 - 0.05 mm</td> </tr> <tr> <td>% Silt:</td> <td>0.05 - 0.002 mm</td> </tr> <tr> <td>% Clay:</td> <td>&lt; 0.002 mm</td> </tr> </tbody> </table>			Particle Size	% Sand:	2.0 - 0.05 mm	% Silt:	0.05 - 0.002 mm	% Clay:	< 0.002 mm																																																														
	Particle Size																																																																						
% Sand:	2.0 - 0.05 mm																																																																						
% Silt:	0.05 - 0.002 mm																																																																						
% Clay:	< 0.002 mm																																																																						
<b>USDA Soil Textural Classification</b> Sand																																																																							

All results apply only to actual locations and materials tested. As a mutual protection to clients, the public and ourselves, all reports are submitted as the confidential property of clients, and authorization for publication of statements, conclusions or extracts from or regarding our reports is reserved pending our written approval.

**Comments:** \_\_\_\_\_  
 \_\_\_\_\_  
 \_\_\_\_\_

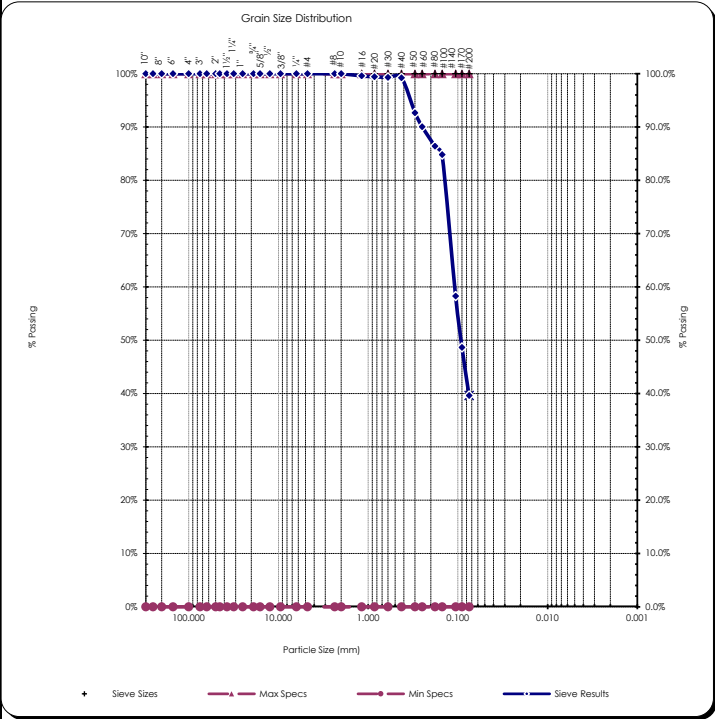
**Reviewed by:**   
 \_\_\_\_\_  
 Meghan Blodgett-Carrillo

# Sieve Report

<b>Project:</b> Q.C. - Lower Duwamish Waterway <b>Project #:</b> 21B233 <b>Client:</b> Anchor QEA <b>Source:</b> LDW21-GT29-GB-28.9-31 ft <b>Sample#:</b> B21-1802	<b>Date Received:</b> 29-Jul-21 <b>Sampled By:</b> Client <b>Date Tested:</b> 20-Sep-21 <b>Tested By:</b> C. Kriss	<b>Unified Soil Classification System, ASTM-2487</b> SM, Silty Sand <b>Sample Color:</b> brown	 <b>ACCREDITED</b> Certificate #: 1366.01
--	---	---	---

<b>ASTM D2216, ASTM D2419, ASTM D4318, ASTM D5281</b>			
<b>Specifications</b> No Specs <b>Sample Meets Specs ? N/A</b>	D <sub>(5)</sub> = 0.009 mm D <sub>(10)</sub> = 0.019 mm D <sub>(15)</sub> = 0.028 mm D <sub>(30)</sub> = 0.057 mm D <sub>(50)</sub> = 0.092 mm D <sub>(60)</sub> = 0.109 mm D <sub>(90)</sub> = 0.249 mm Dust Ratio = 2/5	% Gravel = 0.0% % Sand = 60.4% % Silt & Clay = 39.6% Liquid Limit = n/a Plasticity Index = n/a Sand Equivalent = n/a Fracture %, 1 Face = n/a Fracture %, 2+ Faces = n/a	Coeff. of Curvature, C <sub>c</sub> = 1.57 Coeff. of Uniformity, C <sub>u</sub> = 5.75 Fineness Modulus = 0.24 Plastic Limit = n/a Moisture %, as sampled = 37.2% Req'd Sand Equivalent = Req'd Fracture %, 1 Face = Req'd Fracture %, 2+ Faces =

<b>ASTM C136, ASTM D6913, ASTM C117</b>					
Sieve Size		Actual Cumulative Percent Passing	Interpolated Cumulative Percent Passing	Specs Max	Specs Min
US	Metric				
12.00"	300.00		100%	100.0%	0.0%
10.00"	250.00		100%	100.0%	0.0%
8.00"	200.00		100%	100.0%	0.0%
6.00"	150.00		100%	100.0%	0.0%
4.00"	100.00		100%	100.0%	0.0%
3.00"	75.00		100%	100.0%	0.0%
2.50"	63.00		100%	100.0%	0.0%
2.00"	50.00	100%	100%	100.0%	0.0%
1.75"	45.00	100%	100%	100.0%	0.0%
1.50"	37.50	100%	100%	100.0%	0.0%
1.25"	31.50	100%	100%	100.0%	0.0%
1.00"	25.00	100%	100%	100.0%	0.0%
3/4"	19.00	100%	100%	100.0%	0.0%
5/8"	16.00	100%	100%	100.0%	0.0%
1/2"	12.50	100%	100%	100.0%	0.0%
3/8"	9.50	100%	100%	100.0%	0.0%
1/4"	6.30	100%	100%	100.0%	0.0%
#4	4.75	100%	100%	100.0%	0.0%
#8	2.36	100%	100%	100.0%	0.0%
#10	2.00	100%	100%	100.0%	0.0%
#16	1.18	100%	100%	100.0%	0.0%
#20	0.850	99%	99%	100.0%	0.0%
#30	0.600	99%	99%	100.0%	0.0%
#40	0.425	99%	99%	100.0%	0.0%
#50	0.300	93%	93%	100.0%	0.0%
#60	0.250	90%	90%	100.0%	0.0%
#80	0.180	86%	86%	100.0%	0.0%
#100	0.150	85%	85%	100.0%	0.0%
#140	0.106	58%	58%	100.0%	0.0%
#170	0.090	49%	49%	100.0%	0.0%
#200	0.075	39.6%	39.6%	100.0%	0.0%



Copyright Spears Engineering & Technical Services PS, 1996-98  
 All results apply only to actual locations and materials tested. As a mutual protection to clients, the public and ourselves, all reports are submitted as the confidential property of clients, and authorization for publication of statements, conclusions or extracts from or regarding our reports is reserved pending our written approval.

**Comments:** \_\_\_\_\_

Reviewed by:   
 Meghan Blodgett-Carrillo



**Client:** Anchor QEA  
**Address:** 21328 2nd Drive SE  
Bothell, WA 98021  
**Attn:** Garrett Timm  
**Revised on:** \_\_\_\_\_

**Date:** October 14, 2021  
**Project:** Q.C. - Lower Duwamish Waterway  
**Project #:** 21B233  
**Sample #:** B21-1812 - 1832  
**Date sampled:** July 15, 2021

As requested MTC, Inc. has performed the following test(s) on the sample referenced above. The testing was performed in accordance with current applicable AASHTO or ASTM standards as indicated below. The results obtained in our laboratory were as follows below or on the attached pages:

	Test(s) Performed:	Test Results		Test(s) Performed:	Test Results
X	Sieve Analysis	Please See Attached Reports		Sulfate Soundness	
	Proctor			Bulk Density & Voids	
	Sand Equivalent			WSDOT Degradation	
	Fracture Count			LA Abrasion	
X	Moisture Content	Please See Attached Report	X	Direct Shear	Please See Attached Reports
	Specific Gravity, Coarse		X	Specific Gravity, Soils	Please See Attached Reports
	Specific Gravity, Fine				
X	Hydrometer Analysis	Please See Attached Reports			
X	Atterberg Limits	Please See Attached Reports			

If you have any questions concerning the test results, the procedures used, or if we can be of any further assistance please call on us at the number below.

Respectfully Submitted,  
 Meghan Blodgett-Carrillo  
 WABO Supervising Laboratory Technician





## Moisture Content - ASTM C566, ASTM D2216

**Project:** Q.C. - Lower Duwamish Waterway  
**Project #:** 21B233  
**Date Received:** July 29, 2021  
**Date Tested:** September 23, 2021

**Client:** Anchor QEA  
**Sampled by:** Client  
**Tested by:** A. Eifrig

Sample #	Location	Tare	Wet + Tare	Dry + Tare	Wgt. Of Moisture	Wgt. Of Soil	% Moisture
B21-1812	LDW21-GT25-GB-0-1.5 ft	233.7	903.3	628.8	274.5	395.1	69.5%
B21-1813	LDW21-GT25-GB-0-8.5 ft	260.6	578.9	450.1	128.8	189.5	68.0%
B21-1814	LDW21-GT25-GB-8.5-10 ft	306.5	1244.3	1034.1	210.2	727.6	28.9%
B21-1815	LDW21-GT25-GB-8.5-16.2 ft	234.4	975.8	829.1	146.7	594.7	24.7%
B21-1816	LDW21-GT25-GB-16.2-18.5 ft	301.0	1029.3	834.6	194.7	533.6	36.5%
B21-1817	LDW21-GT25-GB-18.5-20 ft	311.0	1016.3	872.1	144.2	561.1	25.7%
B21-1818	LDW21-GT25-GB-18.5-24.4 ft	182.5	963.7	746.1	217.6	563.6	38.6%
B21-1819	LDW21-GT25-GB-24.4-26ft	268.9	846.8	702.0	144.8	433.1	33.4%
B21-1820	LDW21-GT25-GB-26-28.5 ft	229.0	653.6	545.0	108.6	316.0	34.4%
B21-1821	LDW21-GT25-GB-28.5-30 ft	221.8	847.9	689.3	158.6	467.5	33.9%
B21-1822	LDW21-GT33-GB-0-1.5 ft	223.1	962.3	671.6	290.7	448.5	64.8%
B21-1823	LDW21-GT33-GB-0-10.4 ft	225.2	643.8	515.2	128.6	290.0	44.3%
B21-1824	LDW21-GT33-GB-11-12.5 ft	221.3	1042.8	776.6	266.2	555.3	47.9%
B21-1825	LDW21-GT33-GB-11-18.5 ft	225.3	614.1	543.5	70.6	318.2	22.2%
B21-1826	LDW21-GT33-GB-18.3-21 ft	215.8	753.3	613.6	139.7	397.8	35.1%
B21-1827	LDW21-GT33-GB-21-22.5 ft	220.8	673.2	554.6	118.6	333.8	35.5%
B21-1828	LDW21-GT33-GB-21-26.8 ft	217.3	766.4	626.0	140.4	408.7	34.4%
B21-1829	LDW21-GT33-GB-26.8-28.8 ft	233.1	799.7	630.2	169.5	397.1	42.7%
B21-1830	LDW21-GT33-GB-28.8-29.5 ft	223.1	1026.1	824.1	202.0	601.0	33.6%
B21-1831	LDW21-GT33-GB-29.5-31 ft	221.8	989.1	767.9	221.2	546.1	40.5%
B21-1832	LDW21-GT33-GB-31-32.5 ft	208.9	577.5	479.9	97.6	271.0	36.0%

All results apply only to actual locations and materials tested. As a mutual protection to clients, the public and ourselves, all reports are submitted as the confidential property of clients, and authorization for publication of statements, conclusions or extracts from or regarding our reports is reserved pending our written approval.

Reviewed by:   
 Meghan Blodgett-Carrillo



Moisture Content - ASTM D854

Project: Q.C. - Lower Duwamish Waterway

Client: Anchor QEA

Project #: 21B233

Date Received: July 29, 2021

Sampled by: Client

Date Tested: September 20, 2021

Tested by: A. Eifrig

Table with 15 columns: Sample #, Location, Tare, Dry Soil + Tare, Mass of Dry Soil, Pycno ID, Mass of Pycno, Volume of Pycno, Density of Water @ Tx, Mass of Pycno filled w/ water & soils, Mass of Pycno filled w/ water, Temp. of Water, 0.1 °C, SpG of Soils, Temp. Correction Factor, Corrected SpG. Contains 3 rows of data and several empty rows.

All results apply only to actual locations and materials tested. As a mutual protection to clients, the public and ourselves, all reports are submitted as the confidential property of clients, and authorization for publication of statements, conclusions or extracts from or regarding our reports is reserved pending our written approval.

Reviewed by: [Signature] Meghan Blodgett-Carrillo

# Materials Testing & Consulting, Inc.

Geotechnical Engineering • Special Inspections • Materials Testing • Environmental Consulting



## ASTM D4318 - Liquid Limit, Plastic Limit and Plasticity Index of Soils

<b>Project:</b> Q.C. - Lower Duwamish Waterway <b>Project #:</b> 21B233 <b>Client:</b> Anchor QEA, LLC <b>Source:</b> LDW21-GT25-GB-0-8.5 ft <b>Sample #:</b> B21-1813	<b>Date Received:</b> 29-Jul-21 <b>Sampled By:</b> Client <b>Date Tested:</b> 25-Sep-21 <b>Tested By:</b> K. Mendez	<b>Visual Identification</b> Silt with Clay <b>Sample Color</b> brown
--	--	--

Liquid Limit Determination						
	#1	#2	#3	#4	#5	#6
Weight of Wet Soils + Pan:	29.60	25.42	26.01			
Weight of Dry Soils + Pan:	25.96	21.62	21.93			
Weight of Pan:	19.65	15.20	15.00			
Weight of Dry Soils:	6.31	6.42	6.93			
Weight of Moisture:	3.64	3.80	4.08			
% Moisture:	57.7 %	59.2 %	58.9 %			
Number of Blows:	28	22	17			


Plastic Limit Determination						
	#1	#2	#3	#4	#5	#6
Weight of Wet Soils + Pan:	35.15	34.29				
Weight of Dry Soils + Pan:	33.00	32.39				
Weight of Pan:	28.27	28.20				
Weight of Dry Soils:	4.73	4.19				
Weight of Moisture:	2.15	1.90				
% Moisture:	45.5 %	45.4 %				

**Liquid Limit @ 25 Blows:** 58 %

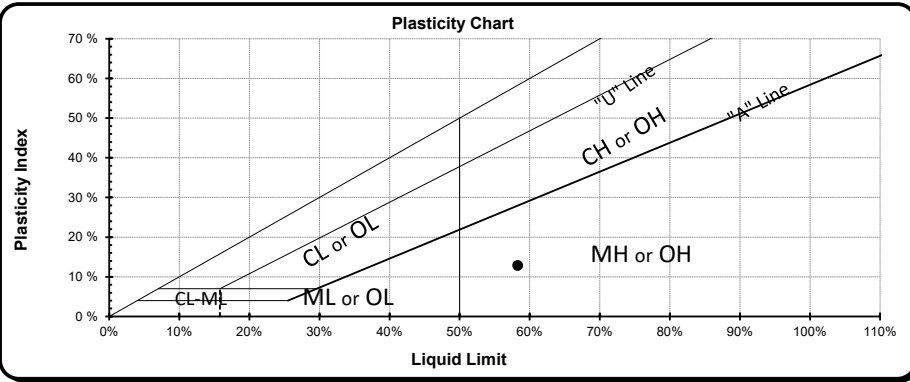
**Plastic Limit:** 45 %

**Plasticity Index, I<sub>p</sub>:** 13 %

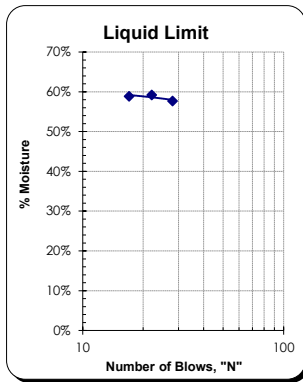


Certificate #: 1366.01, 1366.02 & 1366.04




Copyright Spears Engineering & Technical Services PS, 1996-98



All results apply only to actual locations and materials tested. As a mutual protection to clients, the public and ourselves, all reports are submitted as the confidential property of clients, and authorization for publication of statements, conclusions or extracts from or regarding our reports is reserved pending our written approval.

Comments: \_\_\_\_\_

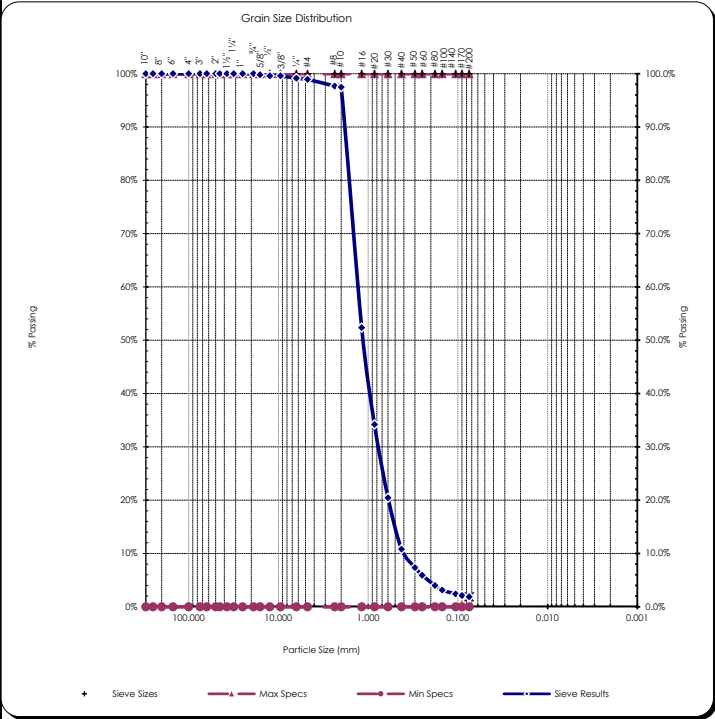
Reviewed by:   
 Meghan Blodgett-Carrillo

# Sieve Report

<b>Project:</b> Q.C. - Lower Duwamish Waterway <b>Project #:</b> 21B233 <b>Client:</b> Anchor QEA <b>Source:</b> LDW21-GT25-GB-8.5-16.2 ft <b>Sample#:</b> B21-1815	<b>Date Received:</b> 29-Jul-21 <b>Sampled By:</b> Client <b>Date Tested:</b> 25-Sep-21 <b>Tested By:</b> K. Mendez	<b>Unified Soil Classification System, ASTM-2487</b> SP, Poorly graded Sand <b>Sample Color:</b> brown	 <b>ACCREDITED</b> Certificate #: 1366.01
---	--	---	---

<b>ASTM D2216, ASTM D2419, ASTM D4318, ASTM D5281</b>			
<b>Specifications</b> No Specs <b>Sample Meets Specs ?</b> N/A	D <sub>(5)</sub> = 0.216 mm D <sub>(10)</sub> = 0.395 mm D <sub>(15)</sub> = 0.501 mm D <sub>(30)</sub> = 0.773 mm D <sub>(50)</sub> = 1.137 mm D <sub>(60)</sub> = 1.318 mm D <sub>(90)</sub> = 1.864 mm Dust Ratio = 17/97	% Gravel = 1.1% % Sand = 97.0% % Silt & Clay = 1.9% Liquid Limit = n/a Plasticity Index = n/a Sand Equivalent = n/a Fracture %, 1 Face = n/a Fracture %, 2+ Faces = n/a	Coeff. of Curvature, C <sub>c</sub> = 1.15 Coeff. of Uniformity, C <sub>u</sub> = 3.34 Fineness Modulus = 3.20 Plastic Limit = n/a Moisture %, as sampled = 24.7% Req'd Sand Equivalent = Req'd Fracture %, 1 Face = Req'd Fracture %, 2+ Faces =

<b>ASTM C136, ASTM D6913, ASTM C117</b>					
Sieve Size		Actual Cumulative Percent Passing	Interpolated Cumulative Percent Passing	Specs Max	Specs Min
US	Metric				
12.00"	300.00		100%	100.0%	0.0%
10.00"	250.00		100%	100.0%	0.0%
8.00"	200.00		100%	100.0%	0.0%
6.00"	150.00		100%	100.0%	0.0%
4.00"	100.00		100%	100.0%	0.0%
3.00"	75.00		100%	100.0%	0.0%
2.50"	63.00		100%	100.0%	0.0%
2.00"	50.00	100%	100%	100.0%	0.0%
1.75"	45.00	100%	100%	100.0%	0.0%
1.50"	37.50	100%	100%	100.0%	0.0%
1.25"	31.50	100%	100%	100.0%	0.0%
1.00"	25.00	100%	100%	100.0%	0.0%
3/4"	19.00	100%	100%	100.0%	0.0%
5/8"	16.00	100%	100%	100.0%	0.0%
1/2"	12.50	100%	100%	100.0%	0.0%
3/8"	9.50	100%	100%	100.0%	0.0%
1/4"	6.30	99%	99%	100.0%	0.0%
#4	4.75	99%	99%	100.0%	0.0%
#8	2.36	98%	98%	100.0%	0.0%
#10	2.00	97%	97%	100.0%	0.0%
#16	1.18	52%	52%	100.0%	0.0%
#20	0.850	34%	34%	100.0%	0.0%
#30	0.600	20%	20%	100.0%	0.0%
#40	0.425	11%	11%	100.0%	0.0%
#50	0.300	7%	7%	100.0%	0.0%
#60	0.250	6%	6%	100.0%	0.0%
#80	0.180	4%	4%	100.0%	0.0%
#100	0.150	3%	3%	100.0%	0.0%
#140	0.106	2%	2%	100.0%	0.0%
#170	0.090	2%	2%	100.0%	0.0%
#200	0.075	1.9%	1.9%	100.0%	0.0%



Copyright Spears Engineering & Technical Services PS, 1996-98

All results apply only to actual locations and materials tested. As a mutual protection to clients, the public and ourselves, all reports are submitted as the confidential property of clients, and authorization for publication of statements, conclusions or extracts from or regarding our reports is reserved pending our written approval.

**Comments:** \_\_\_\_\_

Reviewed by:   
 Meghan Blodgett-Carrillo

# Direct Shear Test Results:

ASTM D-3080



Project: Q.C. - Lower Duwamish Waterway  
 Project Number: 21B233  
 Laboratory Sample ID: B21-1815  
 Sample Date: 7/15/2021  
 Test Date: 9/30/2021  
 Technician: M. Carrillo

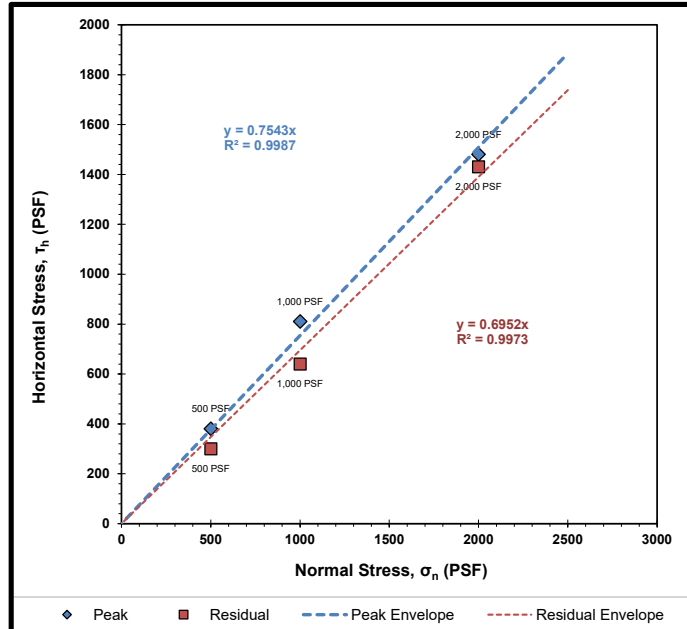
Sample Source: LDW21-GT25-GB-8.5-16.2 ft  
 Visual Soil Description: brown sand with silt  
 Type of Specimen: Remolded Cylindrical Shear Box  
 Specimen Diameter (in): 2.5  
 Specimen Height (in): 1  
 Rate of Strain (in/min): 0.0208  
 Estimated Specific Gravity of Solids: 2.65

Summary of Sample Data: $\sigma_n=500$ PSF		
Initial Moisture Content (%):	25.1	
	Initial	Post-Consolidation
Dry Density (PCF):	108.7	109.7
Void Ratio:	0.550	0.536
Porosity (%):	35.5	34.9
Degree of Saturation (%):	saturated	saturated

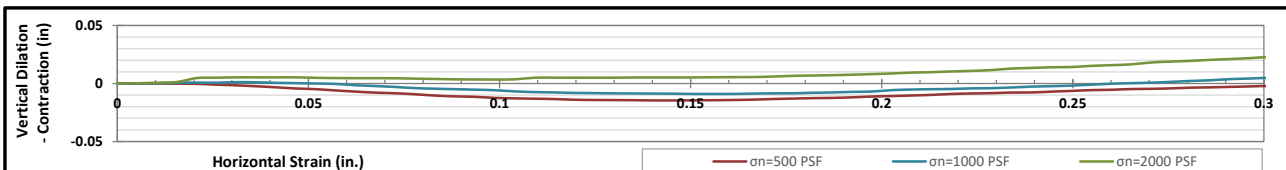
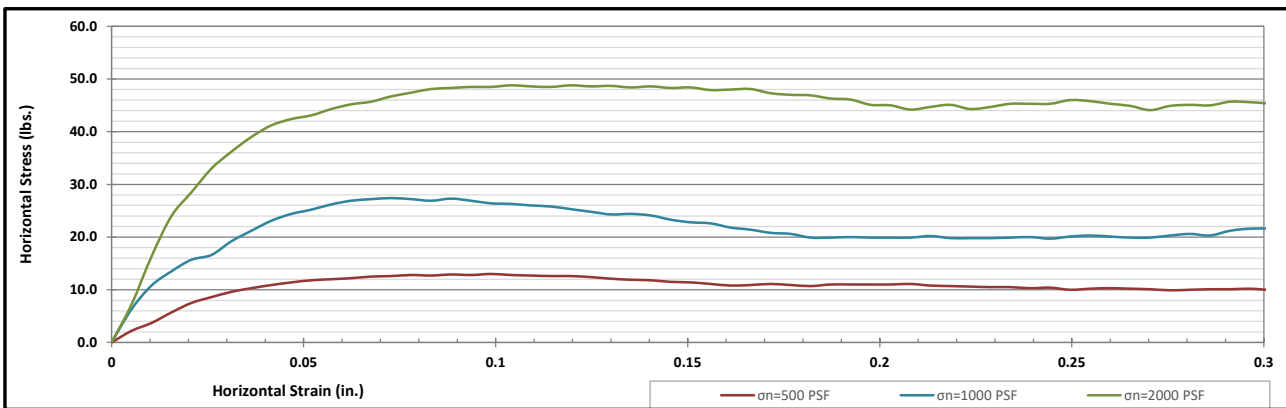
Summary of Sample Data: $\sigma_n=1000$ PSF		
Initial Moisture Content (%):	24.7	
	Initial	Post-Consolidation
Dry Density (PCF):	107.3	108.8
Void Ratio:	0.571	0.549
Porosity (%):	36.3	35.4
Degree of Saturation (%):	saturated	saturated

Summary of Sample Data: $\sigma_n=2000$ PSF		
Initial Moisture Content (%):	25.6	
	Initial	Post-Consolidation
Dry Density (PCF):	107.7	110.3
Void Ratio:	0.564	0.527
Porosity (%):	36.0	34.5
Degree of Saturation (%):	saturated	saturated

ESTIMATED STRENGTH PARAMETERS		
	PEAK	RESIDUAL
Angle of Internal Friction, $\phi$ (°):	37	35
Cohesion (PSF):	0	0



Failure Envelope Test Values:			
Normal Stress, $\sigma_n$ (PSF):	500	1000	2000
Peak Horizontal Stress, $\tau_h$ (PSF):	380	810	1480
Residual Horizontal Stress, $\tau_r$ (PSF):	300	640	1430



Corporate • 777 Chrysler Drive • Burlington, WA 98233 • Phone 360.755.1990 • Fax 360.755.1980  
 SW Region • 2118 Black Lake Blvd. S.W. • Olympia, WA 98512 • Phone 360.534.9777 • Fax 360.534.9779  
 NW Region • 805 Dupont, Suite #5 • Bellingham, WA 98225 • Phone 360.647.6061 • Fax 360.647.8111  
 Kitsap Region • 5451 N.W. Newberry Hill Road, Suite 101 • Silverdale, WA 98383 • Phone/Fax 360.698.6787


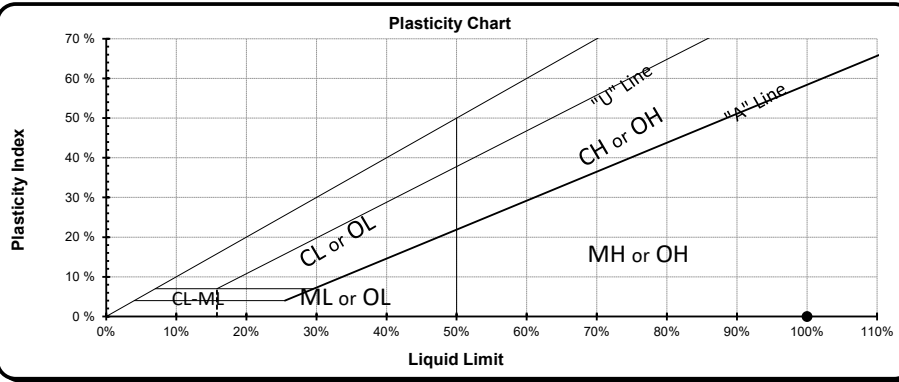
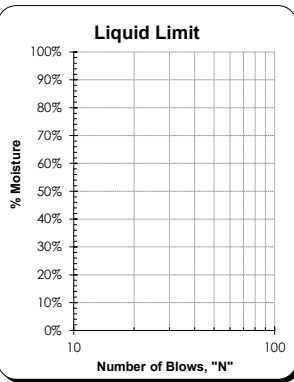
Visit our website: [www.mtc-inc.net](http://www.mtc-inc.net)

# Materials Testing & Consulting, Inc.

Geotechnical Engineering • Special Inspections • Materials Testing • Environmental Consulting



## ASTM D4318 - Liquid Limit, Plastic Limit and Plasticity Index of Soils

<b>Project:</b> Q.C. - Lower Duwamish Waterway <b>Project #:</b> 21B233 <b>Client:</b> Anchor QEA, LLC <b>Source:</b> LDW21-GT25-GB-16.2-18.5 ft <b>Sample #:</b> B21-1816	<b>Date Received:</b> 29-Jul-21 <b>Sampled By:</b> Client <b>Date Tested:</b> 25-Sep-21 <b>Tested By:</b> K. Mendez	<b>Visual Identification</b> Sand <b>Sample Color</b> grayish-brown				
<b>Liquid Limit Determination</b>						
#1                  #2                  #3                  #4                  #5                  #6						
Weight of Wet Soils + Pan:						
Weight of Dry Soils + Pan:	Unable to establish liquid limit					
Weight of Pan:						
Weight of Dry Soils:						
Weight of Moisture:						
% Moisture:						
Number of Blows:						
<b>Liquid Limit @ 25 Blows:</b> N/A <b>Plastic Limit:</b> N/A <b>Plasticity Index, I<sub>p</sub>:</b> N/A						
<b>Plastic Limit Determination</b>						
#1                  #2                  #3                  #4                  #5                  #6						
Weight of Wet Soils + Pan:						
Weight of Dry Soils + Pan:	Cannot determined plastic limit					
Weight of Pan:						
Weight of Dry Soils:						
Weight of Moisture:						
% Moisture:						
 <small>Certificate #: 1366.01, 1366.02 &amp; 1366.04</small>						
						
						

Copyright Spears Engineering & Technical Services PS, 1996-98  
 All results apply only to actual locations and materials tested. As a mutual protection to clients, the public and ourselves, all reports are submitted as the confidential property of clients, and authorization for publication of statements, conclusions or extracts from or regarding our reports is reserved pending our written approval.

**Comments:** Liquid limit cannot be established as the material displays rapid dilation. At lower moistures the material does not spread into the liquid limit device without tearing the soil cake. Plastic limit cannot be determined as the sample does not roll down to 1/8" threads before cracking or crumbling. Non-plastic.


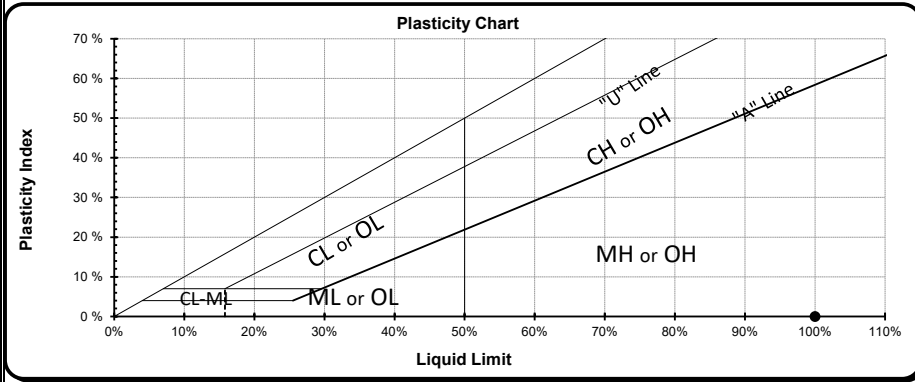
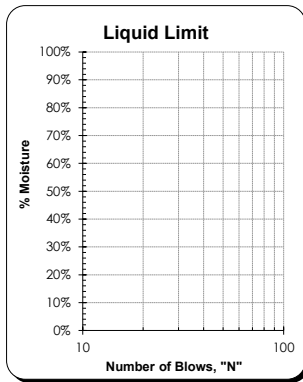
Reviewed by:   
 Meghan Blodgett-Carrillo

# Materials Testing & Consulting, Inc.

Geotechnical Engineering • Special Inspections • Materials Testing • Environmental Consulting



## ASTM D4318 - Liquid Limit, Plastic Limit and Plasticity Index of Soils

<b>Project:</b> Q.C. - Lower Duwamish Waterway <b>Project #:</b> 21B233 <b>Client:</b> Anchor QEA, LLC <b>Source:</b> LDW21-GT25-GB-18.5-24.4 ft <b>Sample #:</b> B21-1818	<b>Date Received:</b> 29-Jul-21 <b>Sampled By:</b> Client <b>Date Tested:</b> 25-Sep-21 <b>Tested By:</b> K. Mendez	<b>Visual Identification</b> Sand <b>Sample Color</b> grayish-brown				
<b>Liquid Limit Determination</b>						
#1                  #2                  #3                  #4                  #5                  #6						
Weight of Wet Soils + Pan:						
Weight of Dry Soils + Pan:	Unable to establish liquid limit					
Weight of Pan:						
Weight of Dry Soils:						
Weight of Moisture:						
% Moisture:						
Number of Blows:						
<b>Liquid Limit @ 25 Blows:</b> N/A <b>Plastic Limit:</b> N/A <b>Plasticity Index, I<sub>p</sub>:</b> N/A						
<b>Plastic Limit Determination</b>						
#1                  #2                  #3                  #4                  #5                  #6						
Weight of Wet Soils + Pan:						
Weight of Dry Soils + Pan:	Cannot determined plastic limit					
Weight of Pan:						
Weight of Dry Soils:						
Weight of Moisture:						
% Moisture:						
 Certificate #: 1366.01, 1366.02 & 1366.04						
						

Copyright Spears Engineering & Technical Services PS, 1996-98  
 All results apply only to actual locations and materials tested. As a mutual protection to clients, the public and ourselves, all reports are submitted as the confidential property of clients, and authorization for publication of statements, conclusions or extracts from or regarding our reports is reserved pending our written approval.

**Comments:** Liquid limit cannot be established as the material displays rapid dilation. At lower moistures the material does not spread into the liquid limit device without tearing the soil cake. Plastic limit cannot be determined as the sample does not roll down to 1/8" threads before cracking or crumbling. Non-plastic.

Reviewed by:   
 Meghan Blodgett-Carrillo

# Sieve Report

<b>Project:</b> Q.C. - Lower Duwamish Waterway <b>Project #:</b> 21B233 <b>Client:</b> Anchor QEA <b>Source:</b> LDW21-GT25-GB-26-28.5 ft <b>Sample#:</b> B21-1820	<b>Date Received:</b> 29-Jul-21 <b>Sampled By:</b> Client <b>Date Tested:</b> 25-Sep-21 <b>Tested By:</b> K. Mendez	<b>Visual Identification</b> Sandy Silt with Clay <b>Sample Color:</b> brown
--	--	---



**ASTM D2216, ASTM D2419, ASTM D4318, ASTM D5281**

**Specifications**

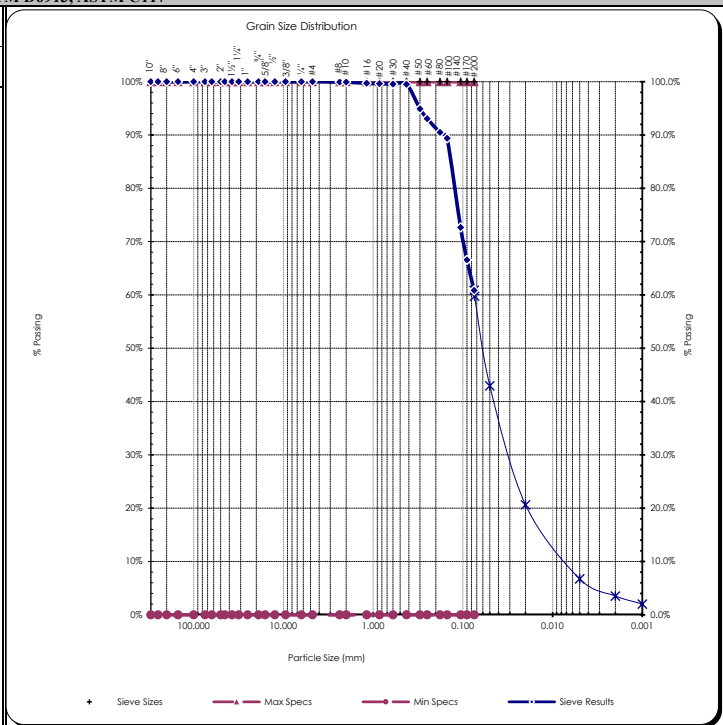
No Specs

**Sample Meets Specs ? N/A**

D <sub>(5)</sub> = 0.003 mm	% Gravel = 0.0%	Coeff. of Curvature, C <sub>c</sub> = 3.28
D <sub>(10)</sub> = 0.008 mm	% Sand = 39.1%	Coeff. of Uniformity, C <sub>u</sub> = 9.69
D <sub>(15)</sub> = 0.013 mm	% Silt & Clay = 60.9%	Fineness Modulus = 0.16
D <sub>(30)</sub> = 0.043 mm	Liquid Limit = n/a	Plastic Limit = n/a
D <sub>(50)</sub> = 0.065 mm	Plasticity Index = n/a	Moisture %, as sampled = 34.2%
D <sub>(60)</sub> = 0.074 mm	Sand Equivalent = n/a	Req'd Sand Equivalent =
D <sub>(90)</sub> = 0.167 mm	Fracture %, 1 Face = n/a	Req'd Fracture %, 1 Face =
Dust Ratio = 11/18	Fracture %, 2+ Faces = n/a	Req'd Fracture %, 2+ Faces =

**ASTM C136, ASTM D6913, ASTM C117**

Sieve Size		Actual Cumulative Percent Passing	Interpolated Cumulative Percent Passing	Specs Max	Specs Min
US	Metric				
12.00"	300.00		100%	100.0%	0.0%
10.00"	250.00		100%	100.0%	0.0%
8.00"	200.00		100%	100.0%	0.0%
6.00"	150.00		100%	100.0%	0.0%
4.00"	100.00		100%	100.0%	0.0%
3.00"	75.00		100%	100.0%	0.0%
2.50"	63.00		100%	100.0%	0.0%
2.00"	50.00	100%	100%	100.0%	0.0%
1.75"	45.00		100%	100.0%	0.0%
1.50"	37.50		100%	100.0%	0.0%
1.25"	31.50		100%	100.0%	0.0%
1.00"	25.00	100%	100%	100.0%	0.0%
3/4"	19.00	100%	100%	100.0%	0.0%
5/8"	16.00		100%	100.0%	0.0%
1/2"	12.50	100%	100%	100.0%	0.0%
3/8"	9.50	100%	100%	100.0%	0.0%
1/4"	6.30		100%	100.0%	0.0%
#4	4.75	100%	100%	100.0%	0.0%
#8	2.36		100%	100.0%	0.0%
#10	2.00	100%	100%	100.0%	0.0%
#16	1.18		100%	100.0%	0.0%
#20	0.850		100%	100.0%	0.0%
#30	0.600		100%	100.0%	0.0%
#40	0.425	100%	100%	100.0%	0.0%
#50	0.300		95%	100.0%	0.0%
#60	0.250		93%	100.0%	0.0%
#80	0.180		90%	100.0%	0.0%
#100	0.150	89%	89%	100.0%	0.0%
#140	0.106		73%	100.0%	0.0%
#170	0.090		67%	100.0%	0.0%
#200	0.075	60.9%	60.9%	100.0%	0.0%



Copyright Spears Engineering & Technical Services PS, 1996-98

All results apply only to actual locations and materials tested. As a mutual protection to clients, the public and ourselves, all reports are submitted as the confidential property of clients, and authorization for publication of statements, conclusions or extracts from or regarding our reports is reserved pending our written approval.

**Comments:**

Reviewed by:   
 Meghan Blodgett-Carrillo



## Hydrometer Report

<b>Project:</b> Q.C. - Lower Duwamish Waterway <b>Project #:</b> 21B233 <b>Client:</b> Anchor QEA <b>Source:</b> LDW21-GT25-GB-26-28.5 ft <b>Sample#:</b> B21-1820	<b>Date Received:</b> 29-Jul-21 <b>Sampled By:</b> Client <b>Date Tested:</b> 25-Sep-21 <b>Tested By:</b> K. Mendez	<b>Visual Identification</b> Sandy Silt with Clay <b>Sample Color</b> brown																																																																																																									
<b>ASTM D7928, HYDROMETER ANALYSIS</b>		<b>ASTM D6913</b>																																																																																																									
Sp Gr : 2.61 Sample Weight: 75.00 grams Hydroscopic Moist.: 10.50% Adj. Sample Wgt : 67.87 grams		Sieve Analysis <b>Grain Size Distribution</b>																																																																																																									
	<table border="1" style="width: 100%; border-collapse: collapse;"> <thead> <tr> <th>Hydrometer Reading Minutes</th> <th>Corrected Reading</th> <th>Percent Passing</th> <th>Soils Particle Diameter</th> </tr> </thead> <tbody> <tr><td>1</td><td>22</td><td>32.7%</td><td>0.0494 mm</td></tr> <tr><td>2</td><td>18</td><td>26.8%</td><td>0.0357 mm</td></tr> <tr><td>5</td><td>15.5</td><td>23.0%</td><td>0.0230 mm</td></tr> <tr><td>15</td><td>10.5</td><td>15.6%</td><td>0.0137 mm</td></tr> <tr><td>30</td><td>9</td><td>13.4%</td><td>0.0097 mm</td></tr> <tr><td>60</td><td>6</td><td>8.9%</td><td>0.0070 mm</td></tr> <tr><td>240</td><td>3.5</td><td>5.2%</td><td>0.0036 mm</td></tr> <tr><td>1440</td><td>2</td><td>3.0%</td><td>0.0015 mm</td></tr> </tbody> </table>	Hydrometer Reading Minutes	Corrected Reading	Percent Passing	Soils Particle Diameter	1	22	32.7%	0.0494 mm	2	18	26.8%	0.0357 mm	5	15.5	23.0%	0.0230 mm	15	10.5	15.6%	0.0137 mm	30	9	13.4%	0.0097 mm	60	6	8.9%	0.0070 mm	240	3.5	5.2%	0.0036 mm	1440	2	3.0%	0.0015 mm	<table border="1" style="width: 100%; border-collapse: collapse;"> <thead> <tr> <th>Sieve Size</th> <th>Percent Passing</th> <th>Soils Particle Diameter</th> </tr> </thead> <tbody> <tr><td>3.0"</td><td>100%</td><td>75.000 mm</td></tr> <tr><td>2.0"</td><td>100%</td><td>50.000 mm</td></tr> <tr><td>1.5"</td><td>100%</td><td>37.500 mm</td></tr> <tr><td>1.25"</td><td>100%</td><td>31.500 mm</td></tr> <tr><td>1.0"</td><td>100%</td><td>25.000 mm</td></tr> <tr><td>3/4"</td><td>100%</td><td>19.000 mm</td></tr> <tr><td>5/8"</td><td>100%</td><td>16.000 mm</td></tr> <tr><td>1/2"</td><td>100%</td><td>12.500 mm</td></tr> <tr><td>3/8"</td><td>100%</td><td>9.500 mm</td></tr> <tr><td>1/4"</td><td>100%</td><td>6.300 mm</td></tr> <tr><td>#4</td><td>100%</td><td>4.750 mm</td></tr> <tr><td>#10</td><td>100%</td><td>2.000 mm</td></tr> <tr><td>#20</td><td>100%</td><td>0.850 mm</td></tr> <tr><td>#40</td><td>100%</td><td>0.425 mm</td></tr> <tr><td>#100</td><td>89%</td><td>0.150 mm</td></tr> <tr><td>#200</td><td>60.9%</td><td>0.075 mm</td></tr> <tr><td><b>Silts</b></td><td>59.8%</td><td>0.074 mm</td></tr> <tr><td></td><td>42.9%</td><td>0.050 mm</td></tr> <tr><td></td><td>20.6%</td><td>0.020 mm</td></tr> <tr><td><b>Clays</b></td><td>6.8%</td><td>0.005 mm</td></tr> <tr><td></td><td>3.5%</td><td>0.002 mm</td></tr> <tr><td><b>Colloids</b></td><td>2.0%</td><td>0.001 mm</td></tr> </tbody> </table>	Sieve Size	Percent Passing	Soils Particle Diameter	3.0"	100%	75.000 mm	2.0"	100%	50.000 mm	1.5"	100%	37.500 mm	1.25"	100%	31.500 mm	1.0"	100%	25.000 mm	3/4"	100%	19.000 mm	5/8"	100%	16.000 mm	1/2"	100%	12.500 mm	3/8"	100%	9.500 mm	1/4"	100%	6.300 mm	#4	100%	4.750 mm	#10	100%	2.000 mm	#20	100%	0.850 mm	#40	100%	0.425 mm	#100	89%	0.150 mm	#200	60.9%	0.075 mm	<b>Silts</b>	59.8%	0.074 mm		42.9%	0.050 mm		20.6%	0.020 mm	<b>Clays</b>	6.8%	0.005 mm		3.5%	0.002 mm	<b>Colloids</b>	2.0%	0.001 mm
Hydrometer Reading Minutes	Corrected Reading	Percent Passing	Soils Particle Diameter																																																																																																								
1	22	32.7%	0.0494 mm																																																																																																								
2	18	26.8%	0.0357 mm																																																																																																								
5	15.5	23.0%	0.0230 mm																																																																																																								
15	10.5	15.6%	0.0137 mm																																																																																																								
30	9	13.4%	0.0097 mm																																																																																																								
60	6	8.9%	0.0070 mm																																																																																																								
240	3.5	5.2%	0.0036 mm																																																																																																								
1440	2	3.0%	0.0015 mm																																																																																																								
Sieve Size	Percent Passing	Soils Particle Diameter																																																																																																									
3.0"	100%	75.000 mm																																																																																																									
2.0"	100%	50.000 mm																																																																																																									
1.5"	100%	37.500 mm																																																																																																									
1.25"	100%	31.500 mm																																																																																																									
1.0"	100%	25.000 mm																																																																																																									
3/4"	100%	19.000 mm																																																																																																									
5/8"	100%	16.000 mm																																																																																																									
1/2"	100%	12.500 mm																																																																																																									
3/8"	100%	9.500 mm																																																																																																									
1/4"	100%	6.300 mm																																																																																																									
#4	100%	4.750 mm																																																																																																									
#10	100%	2.000 mm																																																																																																									
#20	100%	0.850 mm																																																																																																									
#40	100%	0.425 mm																																																																																																									
#100	89%	0.150 mm																																																																																																									
#200	60.9%	0.075 mm																																																																																																									
<b>Silts</b>	59.8%	0.074 mm																																																																																																									
	42.9%	0.050 mm																																																																																																									
	20.6%	0.020 mm																																																																																																									
<b>Clays</b>	6.8%	0.005 mm																																																																																																									
	3.5%	0.002 mm																																																																																																									
<b>Colloids</b>	2.0%	0.001 mm																																																																																																									
<b>USDA Soil Textural Classification</b>																																																																																																											
	<table border="1" style="width: 100%; border-collapse: collapse;"> <thead> <tr> <th>% Sand:</th> <th>Particle Size</th> </tr> </thead> <tbody> <tr><td>39.1%</td><td>2.0 - 0.05 mm</td></tr> <tr><td>54.1%</td><td>0.05 - 0.002 mm</td></tr> <tr><td>6.8%</td><td>&lt; 0.002 mm</td></tr> </tbody> </table>	% Sand:	Particle Size	39.1%	2.0 - 0.05 mm	54.1%	0.05 - 0.002 mm	6.8%	< 0.002 mm																																																																																																		
% Sand:	Particle Size																																																																																																										
39.1%	2.0 - 0.05 mm																																																																																																										
54.1%	0.05 - 0.002 mm																																																																																																										
6.8%	< 0.002 mm																																																																																																										
<b>USDA Soil Textural Classification</b>																																																																																																											
Sandy Loam																																																																																																											

All results apply only to actual locations and materials tested. As a mutual protection to clients, the public and ourselves, all reports are submitted as the confidential property of clients, and authorization for publication of statements, conclusions or extracts from or regarding our reports is reserved pending our written approval.

**Comments:** \_\_\_\_\_

\_\_\_\_\_

\_\_\_\_\_

**Reviewed by:** \_\_\_\_\_  
 Meghan Blodgett-Carrillo





# Sieve Report

<b>Project:</b> Q.C. - Lower Duwamish Waterway <b>Project #:</b> 21B233 <b>Client:</b> Anchor QEA <b>Source:</b> LDW21-GT33-GB-11-18.5 ft <b>Sample#:</b> B21-1825	<b>Date Received:</b> 29-Jul-21 <b>Sampled By:</b> Client <b>Date Tested:</b> 25-Sep-21 <b>Tested By:</b> K. Mendez	<b>Unified Soil Classification System, ASTM-2487</b> SP, Poorly graded Sand <b>Sample Color:</b> brown	 Certificate #: 1366.01
--	--	---	----------------------------

ASTM D2216, ASTM D2419, ASTM D4318, ASTM D5281

**Specifications**

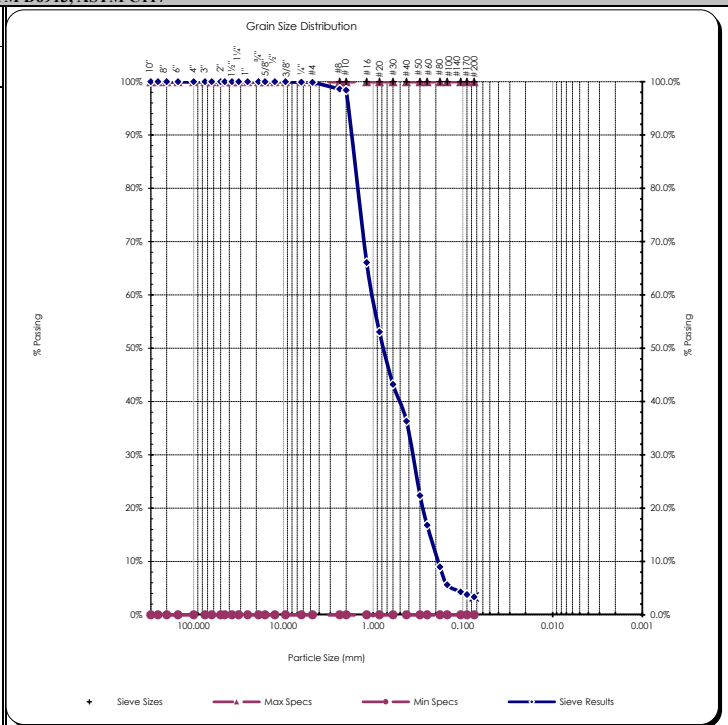
No Specs

Sample Meets Specs ? N/A

D <sub>(5)</sub> = 0.128 mm	% Gravel = 0.1%	Coeff. of Curvature, C <sub>c</sub> = 0.70
D <sub>(10)</sub> = 0.189 mm	% Sand = 96.5%	Coeff. of Uniformity, C <sub>u</sub> = 5.43
D <sub>(15)</sub> = 0.234 mm	% Silt & Clay = 3.4%	Fineness Modulus = 2.64
D <sub>(30)</sub> = 0.368 mm	Liquid Limit = n/a	Plastic Limit = n/a
D <sub>(50)</sub> = 0.772 mm	Plasticity Index = n/a	Moisture %, as sampled = 22.2%
D <sub>(60)</sub> = 1.025 mm	Sand Equivalent = n/a	Req'd Sand Equivalent =
D <sub>(90)</sub> = 1.786 mm	Fracture %, 1 Face = n/a	Req'd Fracture %, 1 Face =
Dust Ratio = 5/54	Fracture %, 2+ Faces = n/a	Req'd Fracture %, 2+ Faces =

ASTM C136, ASTM D6913, ASTM C117

Sieve Size		Actual Cumulative Percent Passing	Interpolated Cumulative Percent Passing	Specs Max	Specs Min
US	Metric				
12.00"	300.00		100%	100.0%	0.0%
10.00"	250.00		100%	100.0%	0.0%
8.00"	200.00		100%	100.0%	0.0%
6.00"	150.00		100%	100.0%	0.0%
4.00"	100.00		100%	100.0%	0.0%
3.00"	75.00		100%	100.0%	0.0%
2.50"	63.00		100%	100.0%	0.0%
2.00"	50.00	100%	100%	100.0%	0.0%
1.75"	45.00		100%	100.0%	0.0%
1.50"	37.50		100%	100.0%	0.0%
1.25"	31.50		100%	100.0%	0.0%
1.00"	25.00	100%	100%	100.0%	0.0%
3/4"	19.00	100%	100%	100.0%	0.0%
5/8"	16.00		100%	100.0%	0.0%
1/2"	12.50	100%	100%	100.0%	0.0%
3/8"	9.50	100%	100%	100.0%	0.0%
1/4"	6.30		100%	100.0%	0.0%
#4	4.75	100%	100%	100.0%	0.0%
#8	2.36		99%	100.0%	0.0%
#10	2.00	98%	98%	100.0%	0.0%
#16	1.18		66%	100.0%	0.0%
#20	0.850		53%	100.0%	0.0%
#30	0.600		43%	100.0%	0.0%
#40	0.425	36%	36%	100.0%	0.0%
#50	0.300		22%	100.0%	0.0%
#60	0.250		17%	100.0%	0.0%
#80	0.180		9%	100.0%	0.0%
#100	0.150	6%	6%	100.0%	0.0%
#140	0.106		4%	100.0%	0.0%
#170	0.090		4%	100.0%	0.0%
#200	0.075	3.4%	3.4%	100.0%	0.0%



Copyright Spears Engineering & Technical Services PS, 1996-98

All results apply only to actual locations and materials tested. As a mutual protection to clients, the public and ourselves, all reports are submitted as the confidential property of clients, and authorization for publication of statements, conclusions or extracts from or regarding our reports is reserved pending our written approval.

**Comments:**

Reviewed by:   
 Meghan Blodgett-Carrillo

# Direct Shear Test Results:

ASTM D-3080



Project: Q.C. - Lower Duwamish Waterway  
 Project Number: 21B233  
 Laboratory Sample ID: B21-1825  
 Sample Date: 7/15/2021  
 Test Date: 10/1/2021  
 Technician: M. Carrillo

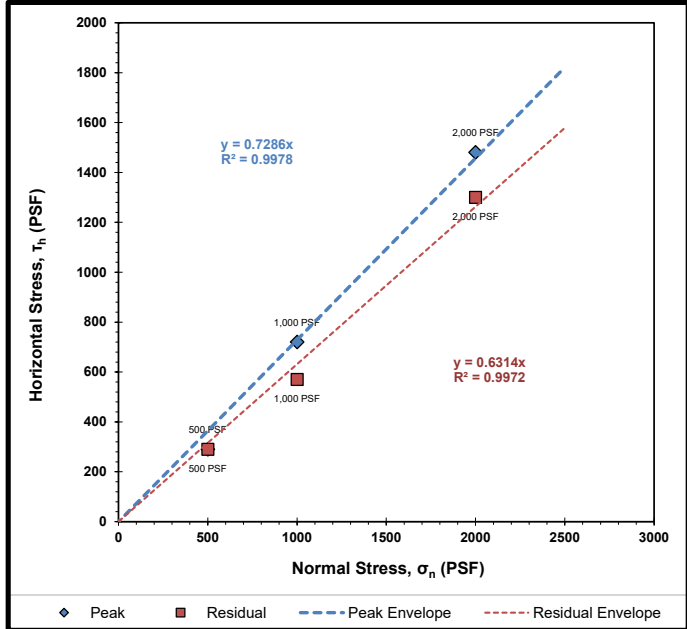
Sample Source: LDW21-GT33-GB-11-18.5 ft  
 Visual Soil Description: brown sand with silt  
 Type of Specimen: Remolded Cylindrical Shear Box  
 Specimen Diameter (in): 2.5  
 Specimen Height (in): 1  
 Rate of Strain (in/min): 0.0208  
 Estimated Specific Gravity of Solids: 2.65

Summary of Sample Data: $\sigma_n=500$ PSF		
Initial Moisture Content (%)	27.4	
	Initial	Post-Consolidation
Dry Density (PCF):	105.9	106.9
Void Ratio:	0.591	0.577
Porosity (%):	37.2	36.6
Degree of Saturation (%):	saturated	saturated

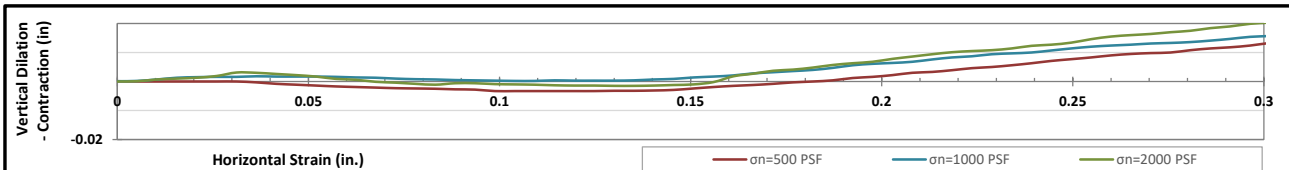
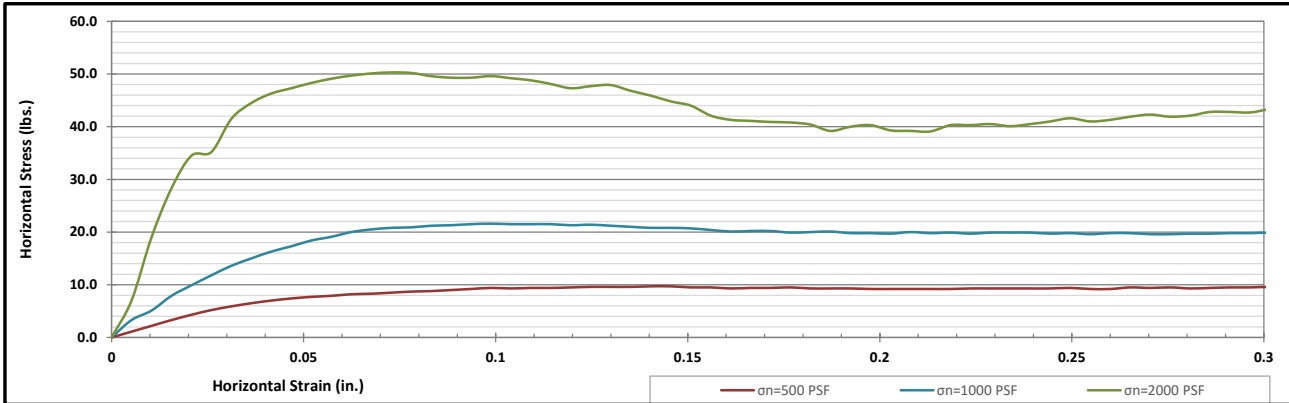
Summary of Sample Data: $\sigma_n=1000$ PSF		
Initial Moisture Content (%)	27.4	
	Initial	Post-Consolidation
Dry Density (PCF):	106.2	107.7
Void Ratio:	0.586	0.564
Porosity (%):	36.9	36.1
Degree of Saturation (%):	saturated	saturated

Summary of Sample Data: $\sigma_n=2000$ PSF		
Initial Moisture Content (%)	26.6	
	Initial	Post-Consolidation
Dry Density (PCF):	106.1	108.6
Void Ratio:	0.589	0.551
Porosity (%):	37.0	35.5
Degree of Saturation (%):	saturated	saturated

ESTIMATED STRENGTH PARAMETERS		
	PEAK	RESIDUAL
Angle of Internal Friction, $\phi$ (°):	38	32
Cohesion (PSF):	0	0



Failure Envelope Test Values:			
Normal Stress, $\sigma_n$ (PSF):	500	1000	2000
Peak Horizontal Stress, $\tau_h$ (PSF):	290	720	1480
Residual Horizontal Stress, $\tau_h$ (PSF):	290	570	1300



Corporate • 777 Chrysler Drive • Burlington, WA 98233 • Phone 360.755.1990 • Fax 360.755.1980  
 SW Region • 2118 Black Lake Blvd. S.W. • Olympia, WA 98512 • Phone 360.534.9777 • Fax 360.534.9779  
 NW Region • 805 Dupont, Suite #5 • Bellingham, WA 98225 • Phone 360.647.6061 • Fax 360.647.8111  
 Kitsap Region • 5451 N.W. Newberry Hill Road, Suite 101 • Silverdale, WA 98383 • Phone/Fax 360.698.6787


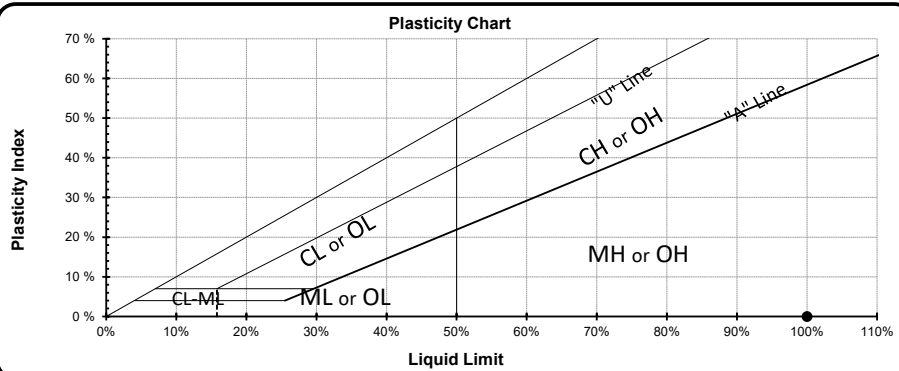
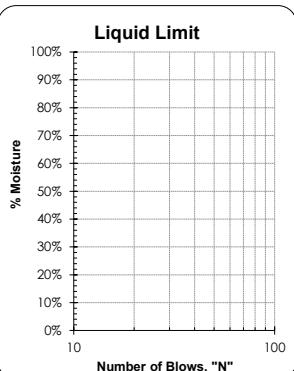
Visit our website: [www.mtc-inc.net](http://www.mtc-inc.net)

# Materials Testing & Consulting, Inc.

Geotechnical Engineering • Special Inspections • Materials Testing • Environmental Consulting



## ASTM D4318 - Liquid Limit, Plastic Limit and Plasticity Index of Soils

<b>Project:</b> Q.C. - Lower Duwamish Waterway <b>Project #:</b> 21B233 <b>Client:</b> Anchor QEA, LLC <b>Source:</b> LDW21-GT23-GB-18.3-21 ft <b>Sample #:</b> B21-1826	<b>Date Received:</b> 29-Jul-21 <b>Sampled By:</b> Client <b>Date Tested:</b> 25-Sep-21 <b>Tested By:</b> K. Mendez	<b>Visual Identification</b> Silty Sand <b>Sample Color</b> brown												
<div style="border: 1px solid red; padding: 2px; display: inline-block; color: red; font-weight: bold;">                     NAME CORRECTION:                      LDW21-GT33-18.5-21                 </div>														
<b>Liquid Limit Determination</b>														
Weight of Wet Soils + Pan: Weight of Dry Soils + Pan: Weight of Pan: Weight of Dry Soils: Weight of Moisture: % Moisture: Number of Blows:	<table border="1" style="width:100%; border-collapse: collapse;"> <tr> <th>#1</th><th>#2</th><th>#3</th><th>#4</th><th>#5</th><th>#6</th></tr> <tr> <td colspan="6" style="text-align: center;">Unable to establish liquid limit</td> </tr> </table>	#1	#2	#3	#4	#5	#6	Unable to establish liquid limit						<b>Liquid Limit @ 25 Blows:</b> N/A <b>Plastic Limit:</b> N/A <b>Plasticity Index, I<sub>p</sub>:</b> N/A
#1	#2	#3	#4	#5	#6									
Unable to establish liquid limit														
<b>Plastic Limit Determination</b>														
Weight of Wet Soils + Pan: Weight of Dry Soils + Pan: Weight of Pan: Weight of Dry Soils: Weight of Moisture: % Moisture:	<table border="1" style="width:100%; border-collapse: collapse;"> <tr> <th>#1</th><th>#2</th><th>#3</th><th>#4</th><th>#5</th><th>#6</th></tr> <tr> <td colspan="6" style="text-align: center;">Cannot determined plastic limit</td> </tr> </table>	#1	#2	#3	#4	#5	#6	Cannot determined plastic limit						 <small>Certificate #: 1366.01, 1366.02 &amp; 1366.04</small>
#1	#2	#3	#4	#5	#6									
Cannot determined plastic limit														
<b>Plasticity Chart</b>														
Plasticity Index		<b>Liquid Limit</b> 												

Copyright Spears Engineering & Technical Services PS, 1996-98  
 All results apply only to actual locations and materials tested. As a mutual protection to clients, the public and ourselves, all reports are submitted as the confidential property of clients, and authorization for publication of statements, conclusions or extracts from or regarding our reports is reserved pending our written approval.

**Comments:** Liquid limit cannot be established as the material displays rapid dilation. At lower moistures the material does not spread into the liquid limit device without tearing the soil cake. Plastic limit cannot be determined as the sample does not roll down to 1/8" threads before cracking or crumbling. Non-plastic.

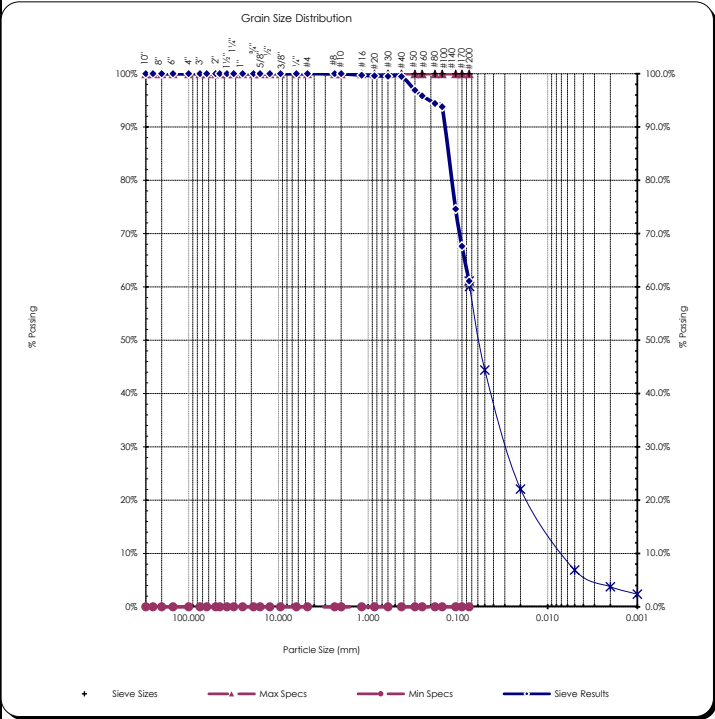
Reviewed by:   
 Meghan Blodgett-Carrillo

# Sieve Report

<b>Project:</b> Q.C. - Lower Duwamish Waterway <b>Project #:</b> 21B233 <b>Client:</b> Anchor QEA <b>Source:</b> LDW21-GT33-GB-21-26.8 ft <b>Sample#:</b> B21-1828	<b>Date Received:</b> 29-Jul-21 <b>Sampled By:</b> Client <b>Date Tested:</b> 25-Sep-21 <b>Tested By:</b> K. Mendez	<b>Unified Soils Classification System, ASTM D-2487</b> ML, Sandy Silt <b>Sample Color:</b> brown	 <b>ACCREDITED</b> Certificate #: 1366.01
--	--	--	---

<b>ASTM D2216, ASTM D2419, ASTM D4318, ASTM D5281</b>			
<b>Specifications</b> No Specs <b>Sample Meets Specs ? N/A</b>	D <sub>(5)</sub> = 0.004 mm D <sub>(10)</sub> = 0.007 mm D <sub>(15)</sub> = 0.010 mm D <sub>(30)</sub> = 0.036 mm D <sub>(50)</sub> = 0.064 mm D <sub>(60)</sub> = 0.074 mm D <sub>(90)</sub> = 0.141 mm Dust Ratio = 43/70	% Gravel = 0.0% % Sand = 38.9% % Silt & Clay = 61.1% Liquid Limit = 0.0% Plasticity Index = 0.0% Sand Equivalent = n/a Fracture %, 1 Face = n/a Fracture %, 2+ Faces = n/a	Coeff. of Curvature, C <sub>c</sub> = 2.51 Coeff. of Uniformity, C <sub>u</sub> = 10.39 Fineness Modulus = 0.10 Plastic Limit = 0.0% Moisture %, as sampled = 34.4% Req'd Sand Equivalent = Req'd Fracture %, 1 Face = Req'd Fracture %, 2+ Faces =

<b>ASTM C136, ASTM D6913, ASTM C117</b>					
Sieve Size		Actual Cumulative Percent Passing	Interpolated Cumulative Percent Passing	Specs Max	Specs Min
US	Metric				
12.00"	300.00		100%	100.0%	0.0%
10.00"	250.00		100%	100.0%	0.0%
8.00"	200.00		100%	100.0%	0.0%
6.00"	150.00		100%	100.0%	0.0%
4.00"	100.00		100%	100.0%	0.0%
3.00"	75.00		100%	100.0%	0.0%
2.50"	63.00		100%	100.0%	0.0%
2.00"	50.00	100%	100%	100.0%	0.0%
1.75"	45.00	100%	100%	100.0%	0.0%
1.50"	37.50	100%	100%	100.0%	0.0%
1.25"	31.50	100%	100%	100.0%	0.0%
1.00"	25.00	100%	100%	100.0%	0.0%
3/4"	19.00	100%	100%	100.0%	0.0%
5/8"	16.00	100%	100%	100.0%	0.0%
1/2"	12.50	100%	100%	100.0%	0.0%
3/8"	9.50	100%	100%	100.0%	0.0%
1/4"	6.30	100%	100%	100.0%	0.0%
#4	4.75	100%	100%	100.0%	0.0%
#8	2.36	100%	100%	100.0%	0.0%
#10	2.00	100%	100%	100.0%	0.0%
#16	1.18	100%	100%	100.0%	0.0%
#20	0.850	100%	100%	100.0%	0.0%
#30	0.600	100%	100%	100.0%	0.0%
#40	0.425	99%	99%	100.0%	0.0%
#50	0.300	97%	97%	100.0%	0.0%
#60	0.250	96%	96%	100.0%	0.0%
#80	0.180	94%	94%	100.0%	0.0%
#100	0.150	94%	94%	100.0%	0.0%
#140	0.106	75%	75%	100.0%	0.0%
#170	0.090	68%	68%	100.0%	0.0%
#200	0.075	61.1%	61.1%	100.0%	0.0%



Copyright Spears Engineering & Technical Services PS, 1996-98

All results apply only to actual locations and materials tested. As a mutual protection to clients, the public and ourselves, all reports are submitted as the confidential property of clients, and authorization for publication of statements, conclusions or extracts from or regarding our reports is reserved pending our written approval.

**Comments:** \_\_\_\_\_

**Reviewed by:**   
 \_\_\_\_\_  
 Meghan Blodgett-Carrillo

# Hydrometer Report

<b>Project:</b> Q.C. - Lower Duwamish Waterway <b>Project #:</b> 21B233 <b>Client:</b> Anchor QEA <b>Source:</b> LDW21-GT33-GB-21-26.8 ft <b>Sample#:</b> B21-1828	<b>Date Received:</b> 29-Jul-21 <b>Sampled By:</b> Client <b>Date Tested:</b> 25-Sep-21 <b>Tested By:</b> K. Mendez	<b>Unified Soils Classification System, ASTM D-2487</b> ML, Sandy Silt <b>Sample Color</b> brown																																																																					
<b>ASTM D7928, HYDROMETER ANALYSIS</b>		<b>ASTM D6913</b>																																																																					
Assumed Sp Gr : 2.65 Sample Weight: 75.85 grams Hydroscopic Moist.: 3.68% Adj. Sample Wgt : 73.16 grams																																																																							
<table style="width: 100%; border-collapse: collapse;"> <thead> <tr> <th style="text-align: left;">Hydrometer Reading</th> <th style="text-align: left;">Corrected Reading</th> <th style="text-align: left;">Percent Passing</th> <th style="text-align: left;">Soils Particle Diameter</th> </tr> </thead> <tbody> <tr><td>1</td><td>25</td><td>34.2%</td><td>0.0477 mm</td></tr> <tr><td>2</td><td>21.5</td><td>29.4%</td><td>0.0347 mm</td></tr> <tr><td>5</td><td>17.5</td><td>23.9%</td><td>0.0224 mm</td></tr> <tr><td>15</td><td>12.5</td><td>17.1%</td><td>0.0133 mm</td></tr> <tr><td>30</td><td>10.5</td><td>14.4%</td><td>0.0096 mm</td></tr> <tr><td>60</td><td>7</td><td>9.6%</td><td>0.0069 mm</td></tr> <tr><td>240</td><td>3.5</td><td>4.8%</td><td>0.0035 mm</td></tr> <tr><td>1440</td><td>2.5</td><td>3.4%</td><td>0.0014 mm</td></tr> </tbody> </table> <table style="width: 100%;"> <tr> <td style="width: 50%;">           % Gravel: 0.0%            % Sand: 38.9%            % Silt: 54.2%            % Clay: 6.9%         </td> <td style="width: 50%; text-align: right;">           Liquid Limit: 0.0 %            Plastic Limit: 0.0 %            Plasticity Index: 0.0 %         </td> </tr> </table>			Hydrometer Reading	Corrected Reading	Percent Passing	Soils Particle Diameter	1	25	34.2%	0.0477 mm	2	21.5	29.4%	0.0347 mm	5	17.5	23.9%	0.0224 mm	15	12.5	17.1%	0.0133 mm	30	10.5	14.4%	0.0096 mm	60	7	9.6%	0.0069 mm	240	3.5	4.8%	0.0035 mm	1440	2.5	3.4%	0.0014 mm	% Gravel: 0.0% % Sand: 38.9% % Silt: 54.2% % Clay: 6.9%	Liquid Limit: 0.0 % Plastic Limit: 0.0 % Plasticity Index: 0.0 %																															
Hydrometer Reading	Corrected Reading	Percent Passing	Soils Particle Diameter																																																																				
1	25	34.2%	0.0477 mm																																																																				
2	21.5	29.4%	0.0347 mm																																																																				
5	17.5	23.9%	0.0224 mm																																																																				
15	12.5	17.1%	0.0133 mm																																																																				
30	10.5	14.4%	0.0096 mm																																																																				
60	7	9.6%	0.0069 mm																																																																				
240	3.5	4.8%	0.0035 mm																																																																				
1440	2.5	3.4%	0.0014 mm																																																																				
% Gravel: 0.0% % Sand: 38.9% % Silt: 54.2% % Clay: 6.9%	Liquid Limit: 0.0 % Plastic Limit: 0.0 % Plasticity Index: 0.0 %																																																																						
<b>USDA Soil Textural Classification</b>		<b>Sieve Analysis</b> <b>Grain Size Distribution</b> <table style="width: 100%; border-collapse: collapse;"> <thead> <tr> <th style="text-align: left;">Sieve Size</th> <th style="text-align: left;">Percent Passing</th> <th style="text-align: left;">Soils Particle Diameter</th> </tr> </thead> <tbody> <tr><td>3.0"</td><td>100%</td><td>75.000 mm</td></tr> <tr><td>2.0"</td><td>100%</td><td>50.000 mm</td></tr> <tr><td>1.5"</td><td>100%</td><td>37.500 mm</td></tr> <tr><td>1.25"</td><td>100%</td><td>31.500 mm</td></tr> <tr><td>1.0"</td><td>100%</td><td>25.000 mm</td></tr> <tr><td>3/4"</td><td>100%</td><td>19.000 mm</td></tr> <tr><td>5/8"</td><td>100%</td><td>16.000 mm</td></tr> <tr><td>1/2"</td><td>100%</td><td>12.500 mm</td></tr> <tr><td>3/8"</td><td>100%</td><td>9.500 mm</td></tr> <tr><td>1/4"</td><td>100%</td><td>6.300 mm</td></tr> <tr><td>#4</td><td>100%</td><td>4.750 mm</td></tr> <tr><td>#10</td><td>100%</td><td>2.000 mm</td></tr> <tr><td>#20</td><td>100%</td><td>0.850 mm</td></tr> <tr><td>#40</td><td>99%</td><td>0.425 mm</td></tr> <tr><td>#100</td><td>94%</td><td>0.150 mm</td></tr> <tr><td>#200</td><td>61.1%</td><td>0.075 mm</td></tr> <tr><td style="text-align: center;">Sils</td><td>60.1%</td><td>0.074 mm</td></tr> <tr><td></td><td>44.4%</td><td>0.050 mm</td></tr> <tr><td></td><td>22.1%</td><td>0.020 mm</td></tr> <tr><td style="text-align: center;">Clays</td><td>6.9%</td><td>0.005 mm</td></tr> <tr><td></td><td>3.8%</td><td>0.002 mm</td></tr> <tr><td style="text-align: center;">Colloids</td><td>2.4%</td><td>0.001 mm</td></tr> </tbody> </table>	Sieve Size	Percent Passing	Soils Particle Diameter	3.0"	100%	75.000 mm	2.0"	100%	50.000 mm	1.5"	100%	37.500 mm	1.25"	100%	31.500 mm	1.0"	100%	25.000 mm	3/4"	100%	19.000 mm	5/8"	100%	16.000 mm	1/2"	100%	12.500 mm	3/8"	100%	9.500 mm	1/4"	100%	6.300 mm	#4	100%	4.750 mm	#10	100%	2.000 mm	#20	100%	0.850 mm	#40	99%	0.425 mm	#100	94%	0.150 mm	#200	61.1%	0.075 mm	Sils	60.1%	0.074 mm		44.4%	0.050 mm		22.1%	0.020 mm	Clays	6.9%	0.005 mm		3.8%	0.002 mm	Colloids	2.4%	0.001 mm
Sieve Size	Percent Passing	Soils Particle Diameter																																																																					
3.0"	100%	75.000 mm																																																																					
2.0"	100%	50.000 mm																																																																					
1.5"	100%	37.500 mm																																																																					
1.25"	100%	31.500 mm																																																																					
1.0"	100%	25.000 mm																																																																					
3/4"	100%	19.000 mm																																																																					
5/8"	100%	16.000 mm																																																																					
1/2"	100%	12.500 mm																																																																					
3/8"	100%	9.500 mm																																																																					
1/4"	100%	6.300 mm																																																																					
#4	100%	4.750 mm																																																																					
#10	100%	2.000 mm																																																																					
#20	100%	0.850 mm																																																																					
#40	99%	0.425 mm																																																																					
#100	94%	0.150 mm																																																																					
#200	61.1%	0.075 mm																																																																					
Sils	60.1%	0.074 mm																																																																					
	44.4%	0.050 mm																																																																					
	22.1%	0.020 mm																																																																					
Clays	6.9%	0.005 mm																																																																					
	3.8%	0.002 mm																																																																					
Colloids	2.4%	0.001 mm																																																																					
<table style="width: 100%;"> <tr> <td style="width: 50%;">           % Sand: 2.0 - 0.05 mm            % Silt: 0.05 - 0.002 mm            % Clay: &lt; 0.002 mm         </td> <td style="width: 50%; text-align: right;"> <b>USDA Soil Textural Classification</b>            Sandy Loam         </td> </tr> </table>		% Sand: 2.0 - 0.05 mm % Silt: 0.05 - 0.002 mm % Clay: < 0.002 mm	<b>USDA Soil Textural Classification</b> Sandy Loam																																																																				
% Sand: 2.0 - 0.05 mm % Silt: 0.05 - 0.002 mm % Clay: < 0.002 mm	<b>USDA Soil Textural Classification</b> Sandy Loam																																																																						

All results apply only to actual locations and materials tested. As a mutual protection to clients, the public and ourselves, all reports are submitted as the confidential property of clients, and authorization for publication of statements, conclusions or extracts from or regarding our reports is reserved pending our written approval.

**Comments:** \_\_\_\_\_

\_\_\_\_\_

\_\_\_\_\_


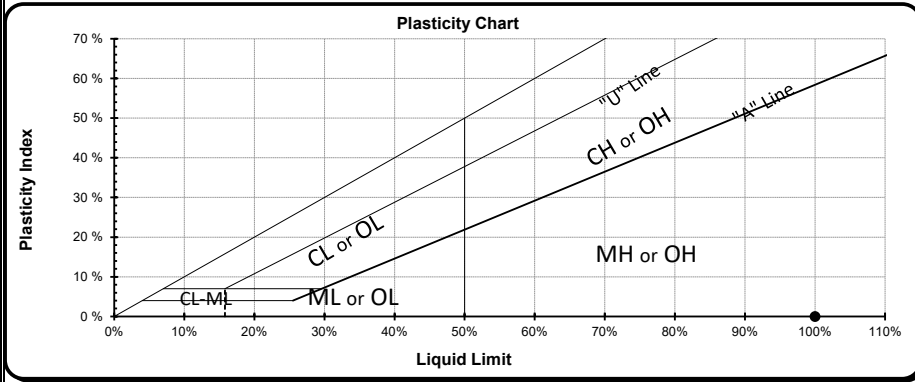
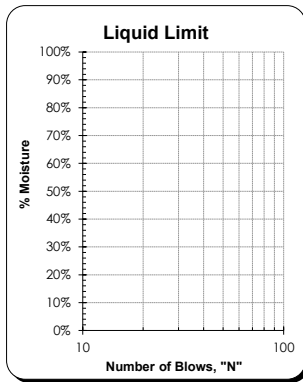
**Reviewed by:** \_\_\_\_\_  
 Meghan Blodgett-Carrillo

# Materials Testing & Consulting, Inc.

Geotechnical Engineering • Special Inspections • Materials Testing • Environmental Consulting



## ASTM D4318 - Liquid Limit, Plastic Limit and Plasticity Index of Soils

<b>Project:</b> Q.C. - Lower Duwamish Waterway <b>Project #:</b> 21B233 <b>Client:</b> Anchor QEA, LLC <b>Source:</b> LDW21-GT33-GB-21-26.8 ft <b>Sample #:</b> B21-1828	<b>Date Received:</b> 29-Jul-21 <b>Sampled By:</b> Client <b>Date Tested:</b> 25-Sep-21 <b>Tested By:</b> K. Mendez	<b>Unified Soils Classification System, ASTM D-2487</b> ML, Sandy Silt <b>Sample Color</b> brown				
<b>Liquid Limit Determination</b>						
#1                  #2                  #3                  #4                  #5                  #6						
Weight of Wet Soils + Pan:						
Weight of Dry Soils + Pan:	Unable to establish liquid limit					
Weight of Pan:						
Weight of Dry Soils:						
Weight of Moisture:						
% Moisture:						
Number of Blows:						
<b>Liquid Limit @ 25 Blows:</b> N/A <b>Plastic Limit:</b> N/A <b>Plasticity Index, I<sub>p</sub>:</b> N/A						
<b>Plastic Limit Determination</b>						
#1                  #2                  #3                  #4                  #5                  #6						
Weight of Wet Soils + Pan:						
Weight of Dry Soils + Pan:	Cannot determined plastic limit					
Weight of Pan:						
Weight of Dry Soils:						
Weight of Moisture:						
% Moisture:						
 <small>Certificate #: 1366.01, 1366.02 &amp; 1366.04</small>						
						
						

Copyright Spears Engineering & Technical Services PS, 1996-98  
 All results apply only to actual locations and materials tested. As a mutual protection to clients, the public and ourselves, all reports are submitted as the confidential property of clients, and authorization for publication of statements, conclusions or extracts from or regarding our reports is reserved pending our written approval.

**Comments:** Liquid limit cannot be established as the material displays rapid dilation. At lower moistures the material does not spread into the liquid limit device without tearing the soil cake. Plastic limit cannot be determined as the sample does not roll down to 1/8" threads before cracking or crumbling. Non-plastic.

Reviewed by:   
 Meghan Blodgett-Carrillo


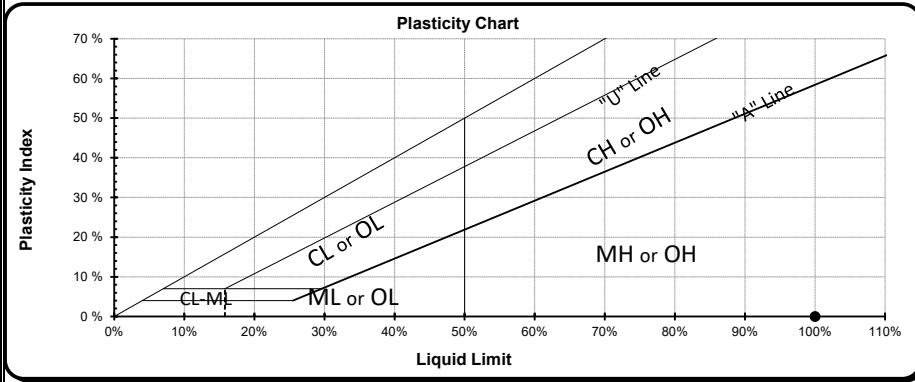
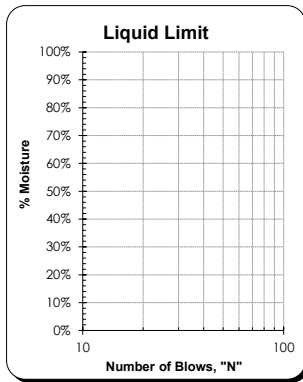


# Materials Testing & Consulting, Inc.

Geotechnical Engineering • Special Inspections • Materials Testing • Environmental Consulting



## ASTM D4318 - Liquid Limit, Plastic Limit and Plasticity Index of Soils

<b>Project:</b> Q.C. - Lower Duwamish Waterway <b>Project #:</b> 21B233 <b>Client:</b> Anchor QEA, LLC <b>Source:</b> LDW21-GT33-GB-26.8-28.8 ft <b>Sample #:</b> B21-1829	<b>Date Received:</b> 29-Jul-21 <b>Sampled By:</b> Client <b>Date Tested:</b> 25-Sep-21 <b>Tested By:</b> K. Mendez	<b>Visual Identification</b> Silty Sand <b>Sample Color</b> brown				
<b>Liquid Limit Determination</b>						
#1                  #2                  #3                  #4                  #5                  #6						
Weight of Wet Soils + Pan:						
Weight of Dry Soils + Pan:	Unable to establish liquid limit					
Weight of Pan:						
Weight of Dry Soils:						
Weight of Moisture:						
% Moisture:						
Number of Blows:						
<b>Liquid Limit @ 25 Blows:</b> N/A <b>Plastic Limit:</b> N/A <b>Plasticity Index, I<sub>p</sub>:</b> N/A						
<b>Plastic Limit Determination</b>						
#1                  #2                  #3                  #4                  #5                  #6						
Weight of Wet Soils + Pan:						
Weight of Dry Soils + Pan:	Cannot determined plastic limit					
Weight of Pan:						
Weight of Dry Soils:						
Weight of Moisture:						
% Moisture:						
						
						
						

Copyright Spears Engineering & Technical Services PS, 1996-98  
 All results apply only to actual locations and materials tested. As a mutual protection to clients, the public and ourselves, all reports are submitted as the confidential property of clients, and authorization for publication of statements, conclusions or extracts from or regarding our reports is reserved pending our written approval.

**Comments:** Liquid limit cannot be established as the material displays rapid dilation. At lower moistures the material does not spread into the liquid limit device without tearing the soil cake. Plastic limit cannot be determined as the sample does not roll down to 1/8" threads before cracking or crumbling. Non-plastic.

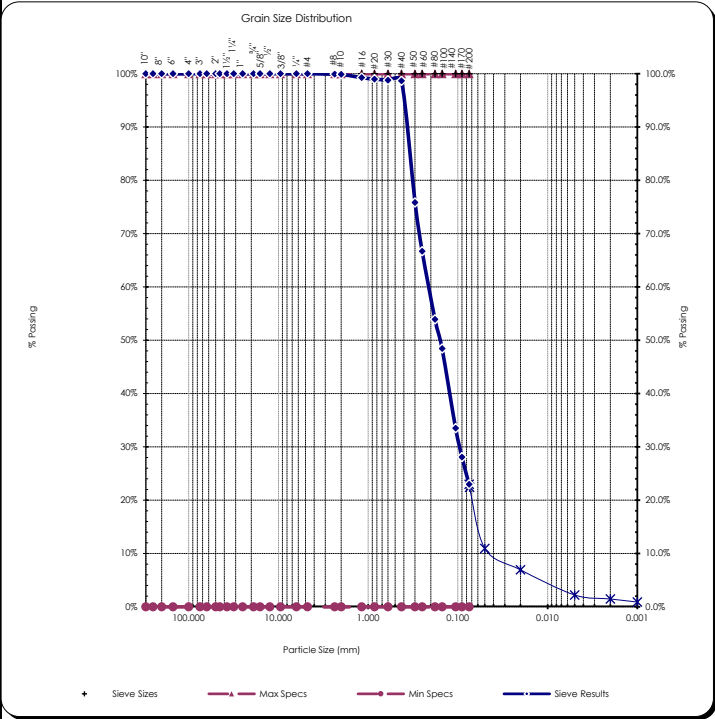
Reviewed by:   
 Meghan Blodgett-Carrillo

# Sieve Report

<b>Project:</b> Q.C. - Lower Duwamish Waterway <b>Project #:</b> 21B233 <b>Client:</b> Anchor QEA <b>Source:</b> LDW21-GT33-GB-28.8-29.5 ft <b>Sample#:</b> B21-1830	<b>Date Received:</b> 29-Jul-21 <b>Sampled By:</b> Client <b>Date Tested:</b> 25-Sep-21 <b>Tested By:</b> K. Mendez	<b>Unified Soils Classification System, ASTM D-2487</b> SM, Silty Sand <b>Sample Color:</b> brown	 <b>ACCREDITED</b> Certificate #: 1366.01
--	--	--	---

<b>ASTM D2216, ASTM D2419, ASTM D4318, ASTM D5281</b>			
<b>Specifications</b> No Specs <b>Sample Meets Specs ?</b> N/A	D <sub>(5)</sub> = 0.010 mm D <sub>(10)</sub> = 0.047 mm D <sub>(15)</sub> = 0.061 mm D <sub>(30)</sub> = 0.096 mm D <sub>(50)</sub> = 0.158 mm D <sub>(60)</sub> = 0.213 mm D <sub>(90)</sub> = 0.378 mm Dust Ratio = 7/30	% Gravel = 0.0% % Sand = 77.0% % Silt & Clay = 23.0% Liquid Limit = n/a Plasticity Index = n/a Sand Equivalent = n/a Fracture %, 1 Face = n/a Fracture %, 2+ Faces = n/a	Coeff. of Curvature, C <sub>c</sub> = 0.90 Coeff. of Uniformity, C <sub>u</sub> = 4.50 Fineness Modulus = 0.78 Plastic Limit = n/a Moisture %, as sampled = 33.6% Req'd Sand Equivalent = Req'd Fracture %, 1 Face = Req'd Fracture %, 2+ Faces =

<b>ASTM C136, ASTM D6913, ASTM C117</b>					
Sieve Size		Actual Cumulative Percent Passing	Interpolated Cumulative Percent Passing	Specs Max	Specs Min
US	Metric				
12.00"	300.00		100%	100.0%	0.0%
10.00"	250.00		100%	100.0%	0.0%
8.00"	200.00		100%	100.0%	0.0%
6.00"	150.00		100%	100.0%	0.0%
4.00"	100.00		100%	100.0%	0.0%
3.00"	75.00		100%	100.0%	0.0%
2.50"	63.00		100%	100.0%	0.0%
2.00"	50.00	100%	100%	100.0%	0.0%
1.75"	45.00	100%	100%	100.0%	0.0%
1.50"	37.50	100%	100%	100.0%	0.0%
1.25"	31.50	100%	100%	100.0%	0.0%
1.00"	25.00	100%	100%	100.0%	0.0%
3/4"	19.00	100%	100%	100.0%	0.0%
5/8"	16.00	100%	100%	100.0%	0.0%
1/2"	12.50	100%	100%	100.0%	0.0%
3/8"	9.50	100%	100%	100.0%	0.0%
1/4"	6.30	100%	100%	100.0%	0.0%
#4	4.75	100%	100%	100.0%	0.0%
#8	2.36	100%	100%	100.0%	0.0%
#10	2.00	100%	100%	100.0%	0.0%
#16	1.18	99%	99%	100.0%	0.0%
#20	0.850	99%	99%	100.0%	0.0%
#30	0.600	99%	99%	100.0%	0.0%
#40	0.425	99%	99%	100.0%	0.0%
#50	0.300	76%	76%	100.0%	0.0%
#60	0.250	67%	67%	100.0%	0.0%
#80	0.180	54%	54%	100.0%	0.0%
#100	0.150	48%	48%	100.0%	0.0%
#140	0.106	34%	34%	100.0%	0.0%
#170	0.090	28%	28%	100.0%	0.0%
#200	0.075	23.0%	23.0%	100.0%	0.0%




Copyright Spears Engineering & Technical Services PS, 1996-98  
 All results apply only to actual locations and materials tested. As a mutual protection to clients, the public and ourselves, all reports are submitted as the confidential property of clients, and authorization for publication of statements, conclusions or extracts from or regarding our reports is reserved pending our written approval.

**Comments:** \_\_\_\_\_

Reviewed by:   
 Meghan Blodgett-Carrillo



## Hydrometer Report

<b>Project:</b> Q.C. - Lower Duwamish Waterway <b>Project #:</b> 21B233 <b>Client:</b> Anchor QEA <b>Source:</b> LDW21-GT33-GB-28.8-29.5 ft <b>Sample#:</b> B21-1830	<b>Date Received:</b> 29-Jul-21 <b>Sampled By:</b> Client <b>Date Tested:</b> 25-Sep-21 <b>Tested By:</b> K. Mendez	<b>Unified Soils Classification System, ASTM D-2487</b> SM, Silty Sand <b>Sample Color</b> brown																																																																					
<b>ASTM D7928, HYDROMETER ANALYSIS</b>		<b>ASTM D6913</b>																																																																					
Assumed Sp Gr : 2.65 Sample Weight: 80.02 grams Hydroscopic Moist.: 4.80% Adj. Sample Wgt : 76.35 grams		<b>Sieve Analysis</b> <b>Grain Size Distribution</b>																																																																					
		<table border="1" style="width: 100%; border-collapse: collapse;"> <thead> <tr> <th>Sieve Size</th> <th>Percent Passing</th> <th>Soils Particle Diameter</th> </tr> </thead> <tbody> <tr><td>3.0"</td><td>100%</td><td>75.000 mm</td></tr> <tr><td>2.0"</td><td>100%</td><td>50.000 mm</td></tr> <tr><td>1.5"</td><td>100%</td><td>37.500 mm</td></tr> <tr><td>1.25"</td><td>100%</td><td>31.500 mm</td></tr> <tr><td>1.0"</td><td>100%</td><td>25.000 mm</td></tr> <tr><td>3/4"</td><td>100%</td><td>19.000 mm</td></tr> <tr><td>5/8"</td><td>100%</td><td>16.000 mm</td></tr> <tr><td>1/2"</td><td>100%</td><td>12.500 mm</td></tr> <tr><td>3/8"</td><td>100%</td><td>9.500 mm</td></tr> <tr><td>1/4"</td><td>100%</td><td>6.300 mm</td></tr> <tr><td>#4</td><td>100%</td><td>4.750 mm</td></tr> <tr><td>#10</td><td>100%</td><td>2.000 mm</td></tr> <tr><td>#20</td><td>99%</td><td>0.850 mm</td></tr> <tr><td>#40</td><td>99%</td><td>0.425 mm</td></tr> <tr><td>#100</td><td>48%</td><td>0.150 mm</td></tr> <tr><td>#200</td><td>23.0%</td><td>0.075 mm</td></tr> <tr><td><b>Silts</b></td><td>22.4%</td><td>0.074 mm</td></tr> <tr><td></td><td>10.9%</td><td>0.050 mm</td></tr> <tr><td></td><td>6.9%</td><td>0.020 mm</td></tr> <tr><td><b>Clays</b></td><td>2.2%</td><td>0.005 mm</td></tr> <tr><td></td><td>1.5%</td><td>0.002 mm</td></tr> <tr><td><b>Colloids</b></td><td>0.9%</td><td>0.001 mm</td></tr> </tbody> </table>	Sieve Size	Percent Passing	Soils Particle Diameter	3.0"	100%	75.000 mm	2.0"	100%	50.000 mm	1.5"	100%	37.500 mm	1.25"	100%	31.500 mm	1.0"	100%	25.000 mm	3/4"	100%	19.000 mm	5/8"	100%	16.000 mm	1/2"	100%	12.500 mm	3/8"	100%	9.500 mm	1/4"	100%	6.300 mm	#4	100%	4.750 mm	#10	100%	2.000 mm	#20	99%	0.850 mm	#40	99%	0.425 mm	#100	48%	0.150 mm	#200	23.0%	0.075 mm	<b>Silts</b>	22.4%	0.074 mm		10.9%	0.050 mm		6.9%	0.020 mm	<b>Clays</b>	2.2%	0.005 mm		1.5%	0.002 mm	<b>Colloids</b>	0.9%	0.001 mm
Sieve Size	Percent Passing	Soils Particle Diameter																																																																					
3.0"	100%	75.000 mm																																																																					
2.0"	100%	50.000 mm																																																																					
1.5"	100%	37.500 mm																																																																					
1.25"	100%	31.500 mm																																																																					
1.0"	100%	25.000 mm																																																																					
3/4"	100%	19.000 mm																																																																					
5/8"	100%	16.000 mm																																																																					
1/2"	100%	12.500 mm																																																																					
3/8"	100%	9.500 mm																																																																					
1/4"	100%	6.300 mm																																																																					
#4	100%	4.750 mm																																																																					
#10	100%	2.000 mm																																																																					
#20	99%	0.850 mm																																																																					
#40	99%	0.425 mm																																																																					
#100	48%	0.150 mm																																																																					
#200	23.0%	0.075 mm																																																																					
<b>Silts</b>	22.4%	0.074 mm																																																																					
	10.9%	0.050 mm																																																																					
	6.9%	0.020 mm																																																																					
<b>Clays</b>	2.2%	0.005 mm																																																																					
	1.5%	0.002 mm																																																																					
<b>Colloids</b>	0.9%	0.001 mm																																																																					
<table border="1" style="width: 100%; border-collapse: collapse;"> <thead> <tr> <th>Hydrometer Reading Minutes</th> <th>Corrected Reading</th> <th>Percent Passing</th> <th>Soils Particle Diameter</th> </tr> </thead> <tbody> <tr><td>1</td><td>8</td><td>10.5%</td><td>0.0529 mm</td></tr> <tr><td>2</td><td>7</td><td>9.2%</td><td>0.0376 mm</td></tr> <tr><td>5</td><td>5.5</td><td>7.2%</td><td>0.0240 mm</td></tr> <tr><td>15</td><td>5</td><td>6.5%</td><td>0.0139 mm</td></tr> <tr><td>30</td><td>4</td><td>5.2%</td><td>0.0098 mm</td></tr> <tr><td>60</td><td>2</td><td>2.6%</td><td>0.0070 mm</td></tr> <tr><td>240</td><td>1.5</td><td>2.0%</td><td>0.0035 mm</td></tr> <tr><td>1440</td><td>1</td><td>1.3%</td><td>0.0014 mm</td></tr> </tbody> </table>		Hydrometer Reading Minutes	Corrected Reading	Percent Passing	Soils Particle Diameter	1	8	10.5%	0.0529 mm	2	7	9.2%	0.0376 mm	5	5.5	7.2%	0.0240 mm	15	5	6.5%	0.0139 mm	30	4	5.2%	0.0098 mm	60	2	2.6%	0.0070 mm	240	1.5	2.0%	0.0035 mm	1440	1	1.3%	0.0014 mm																																		
Hydrometer Reading Minutes	Corrected Reading	Percent Passing	Soils Particle Diameter																																																																				
1	8	10.5%	0.0529 mm																																																																				
2	7	9.2%	0.0376 mm																																																																				
5	5.5	7.2%	0.0240 mm																																																																				
15	5	6.5%	0.0139 mm																																																																				
30	4	5.2%	0.0098 mm																																																																				
60	2	2.6%	0.0070 mm																																																																				
240	1.5	2.0%	0.0035 mm																																																																				
1440	1	1.3%	0.0014 mm																																																																				
% Gravel: 0.0% % Sand: 77.0% % Silt: 20.8% % Clay: 2.2%		Liquid Limit: n/a Plastic Limit: n/a Plasticity Index: n/a																																																																					
<b>USDA Soil Textural Classification</b>																																																																							
<table border="1" style="width: 100%; border-collapse: collapse;"> <thead> <tr> <th></th> <th>Particle Size</th> </tr> </thead> <tbody> <tr><td>% Sand:</td><td>2.0 - 0.05 mm</td></tr> <tr><td>% Silt:</td><td>0.05 - 0.002 mm</td></tr> <tr><td>% Clay:</td><td>&lt; 0.002 mm</td></tr> </tbody> </table>			Particle Size	% Sand:	2.0 - 0.05 mm	% Silt:	0.05 - 0.002 mm	% Clay:	< 0.002 mm																																																														
	Particle Size																																																																						
% Sand:	2.0 - 0.05 mm																																																																						
% Silt:	0.05 - 0.002 mm																																																																						
% Clay:	< 0.002 mm																																																																						
<b>USDA Soil Textural Classification</b>																																																																							
Sand																																																																							

All results apply only to actual locations and materials tested. As a mutual protection to clients, the public and ourselves, all reports are submitted as the confidential property of clients, and authorization for publication of statements, conclusions or extracts from or regarding our reports is reserved pending our written approval.

**Comments:** \_\_\_\_\_

\_\_\_\_\_

\_\_\_\_\_

**Reviewed by:**  \_\_\_\_\_  
 Meghan Blodgett-Carrillo

# Materials Testing & Consulting, Inc.

Geotechnical Engineering • Special Inspections • Materials Testing • Environmental Consulting



## ASTM D4318 - Liquid Limit, Plastic Limit and Plasticity Index of Soils

<b>Project:</b> Q.C. - Lower Duwamish Waterway <b>Project #:</b> 21B233 <b>Client:</b> Anchor QEA, LLC <b>Source:</b> LDW21-GT33-GB-29.5-31 ft <b>Sample #:</b> B21-1831	<b>Date Received:</b> 29-Jul-21 <b>Sampled By:</b> Client <b>Date Tested:</b> 25-Sep-21 <b>Tested By:</b> K. Mendez	<b>Visual Identification</b> Sandy Silt <b>Sample Color</b> brown				
<b>Liquid Limit Determination</b>						
#1                  #2                  #3                  #4                  #5                  #6						
Weight of Wet Soils + Pan:						
Weight of Dry Soils + Pan:	Unable to establish liquid limit					
Weight of Pan:						
Weight of Dry Soils:						
Weight of Moisture:						
% Moisture:						
Number of Blows:						
<b>Liquid Limit @ 25 Blows:</b> N/A <b>Plastic Limit:</b> N/A <b>Plasticity Index, I<sub>p</sub>:</b> N/A						
<b>Plastic Limit Determination</b>						
#1                  #2                  #3                  #4                  #5                  #6						
Weight of Wet Soils + Pan:						
Weight of Dry Soils + Pan:	Cannot determined plastic limit					
Weight of Pan:						
Weight of Dry Soils:						
Weight of Moisture:						
% Moisture:						
<small>Certificate #: 1366.01, 1366.02 &amp; 1366.04</small>						

Copyright Spears Engineering & Technical Services PS, 1996-98  
 All results apply only to actual locations and materials tested. As a mutual protection to clients, the public and ourselves, all reports are submitted as the confidential property of clients, and authorization for publication of statements, conclusions or extracts from or regarding our reports is reserved pending our written approval.

**Comments:** Liquid limit cannot be established as the material displays rapid dilation. At lower moistures the material does not spread into the liquid limit device without tearing the soil cake. Plastic limit cannot be determined as the sample does not roll down to 1/8" threads before cracking or crumbling. Non-plastic.

Reviewed by:   
 Meghan Blodgett-Carrillo



**Client:** Anchor QEA  
**Address:** 21328 2nd Drive SE  
Bothell, WA 98021  
**Attn:** Garrett Timm  
**Revised on:** \_\_\_\_\_

**Date:** October 19, 2021  
**Project:** Q.C. - Lower Duwamish Waterway  
**Project #:** 21B233  
**Sample #:** B21-1948 - 1965  
**Date sampled:** July 16, 2021

As requested MTC, Inc. has performed the following test(s) on the sample referenced above. The testing was performed in accordance with current applicable AASHTO or ASTM standards as indicated below. The results obtained in our laboratory were as follows below or on the attached pages:

	Test(s) Performed:	Test Results		Test(s) Performed:	Test Results
X	Sieve Analysis	Please See Attached Reports		Sulfate Soundness	
	Proctor			Bulk Density & Voids	
	Sand Equivalent			WSDOT Degradation	
	Fracture Count			LA Abrasion	
X	Moisture Content	Please See Attached Report	X	Direct Shear	Please See Attached Reports
	Specific Gravity, Coarse		X	Specific Gravity, Soils	Please See Attached Reports
	Specific Gravity, Fine				
X	Hydrometer Analysis	Please See Attached Reports			
X	Atterberg Limits	Please See Attached Reports			

If you have any questions concerning the test results, the procedures used, or if we can be of any further assistance please call on us at the number below.

Respectfully Submitted,  
 Meghan Blodgett-Carrillo  
 WABO Supervising Laboratory Technician



## Moisture Content - ASTM C566, ASTM D2216

**Project:** Q.C. - Lower Duwamish Waterway  
**Project #:** 21B233  
**Date Received:** July 29, 2021  
**Date Tested:** October 1, 2021

**Client:** Anchor QEA  
**Sampled by:** Client  
**Tested by:** A. Eifrig

Sample #	Location	Tare	Wet + Tare	Dry + Tare	Wgt. Of Moisture	Wgt. Of Soil	% Moisture
B21-1948	LDW21-GT39-GB-0-1.5 ft	182.2	359.3	304.7	54.6	122.5	44.6%
B21-1949	LDW21-GT39-GB-0-8.8 ft	229.5	1120.6	890.6	230.0	661.1	34.8%
B21-1950	LDW21-GT39-GB-8.8-10.5 ft	234.3	1839.1	1517.6	321.5	1283.3	25.1%
B21-1951	LDW21-GT39-GB-10.5-12 ft	222.9	1270.1	1072.1	198.0	849.2	23.3%
B21-1952	LDW21-GT39-GB-10.5-20.5 ft	228.8	652.9	584.6	68.3	355.8	19.2%
B21-1953	LDW21-GT39-GB-20.5-21 ft	225.2	577.3	508.6	68.7	283.4	24.2%
B21-1954	LDW21-GT39-GB-20.5-30.5 ft	234.4	1327.0	1148.4	178.6	914.0	19.5%
B21-1955	LDW21-GT39-GB-30.5-32 ft	233.2	876.4	747.6	128.8	514.4	25.0%
B21-1956	LDW21-GT23-GB-0-1.5 ft	223.0	462.7	361.7	101.0	138.7	72.8%
B21-1957	LDW21-GT23-GB-0-8.2 ft	221.9	900.9	625.0	275.9	403.1	68.4%
B21-1958	LDW21-GT23-GB-8.5-10 ft	215.4	919.5	775.8	143.7	560.4	25.6%
B21-1959	LDW21-GT23-GB-8.5-17.6 ft	234.7	1060.0	934.4	125.6	699.7	18.0%
B21-1960	LDW21-GT23-GB-17.6-18.5 ft	217.3	972.1	771.5	200.6	554.2	36.2%
B21-1961	LDW21-GT23-GB-18.5-20 ft	270.1	687.9	581.4	106.5	311.3	34.2%
B21-1962	LDW21-GT23-GB-21.1-22.8 ft	222.3	1022.4	815.3	207.1	593.0	34.9%
B21-1963	LDW21-GT23-GB-22.8-26.8 ft	266.3	870.9	724.1	146.8	457.8	32.1%
B21-1964	LDW21-GT23-GB-27.7-28.5 ft	224.7	963.8	779.9	183.9	555.2	33.1%
B21-1965	LDW21-GT23-GB-30.5-32 ft	235.2	627.7	539.1	88.6	303.9	29.2%

All results apply only to actual locations and materials tested. As a mutual protection to clients, the public and ourselves, all reports are submitted as the confidential property of clients, and authorization for publication of statements, conclusions or extracts from or regarding our reports is reserved pending our written approval.

Reviewed by: 

Meghan Blodgett-Carrillo  
 Environmental • Geotechnical Engineering • Special Inspection • Non-Destructive Testing • Materials Testing  
 Burlington | Olympia | Bellingham | Silverdale | Tukwila  
 360.755.1990  
 www.mtc-inc.net



# Materials Testing & Consulting, Inc.

Geotechnical Engineering • Special Inspections • Materials Testing • Environmental Consulting



## ASTM D4318 - Liquid Limit, Plastic Limit and Plasticity Index of Soils

<b>Project:</b> Q.C. - Lower Duwamish Waterway <b>Project #:</b> 21B233 <b>Client:</b> Anchor QEA, LLC <b>Source:</b> LDW21-GT39-GB-0-8.8 ft <b>Sample #:</b> B21-1949	<b>Date Received:</b> 29-Jul-21 <b>Sampled By:</b> Client <b>Date Tested:</b> 6-Oct-21 <b>Tested By:</b> C. Kriss	<b>Visual Identification</b> Silt with Sand <b>Sample Color</b> brown																										
<b>Liquid Limit Determination</b>																												
<table border="1" style="width:100%; border-collapse: collapse;"> <thead> <tr> <th></th> <th>#1</th> <th>#2</th> <th>#3</th> <th>#4</th> <th>#5</th> <th>#6</th> </tr> </thead> <tbody> <tr> <td>Weight of Wet Soils + Pan:</td> <td colspan="6" rowspan="6" style="background-color: yellow; text-align: center;">Unable to determine</td> </tr> <tr> <td>Weight of Dry Soils + Pan:</td> </tr> <tr> <td>Weight of Pan:</td> </tr> <tr> <td>Weight of Dry Soils:</td> </tr> <tr> <td>Weight of Moisture:</td> </tr> <tr> <td>% Moisture:</td> </tr> <tr> <td>Number of Blows:</td> <td colspan="6" style="background-color: yellow;"></td> </tr> </tbody> </table>				#1	#2	#3	#4	#5	#6	Weight of Wet Soils + Pan:	Unable to determine						Weight of Dry Soils + Pan:	Weight of Pan:	Weight of Dry Soils:	Weight of Moisture:	% Moisture:	Number of Blows:						
	#1	#2	#3	#4	#5	#6																						
Weight of Wet Soils + Pan:	Unable to determine																											
Weight of Dry Soils + Pan:																												
Weight of Pan:																												
Weight of Dry Soils:																												
Weight of Moisture:																												
% Moisture:																												
Number of Blows:																												
<b>Liquid Limit @ 25 Blows:</b> N/A <b>Plastic Limit:</b> N/A <b>Plasticity Index, I<sub>p</sub>:</b> N/A																												
<b>Plastic Limit Determination</b>																												
<table border="1" style="width:100%; border-collapse: collapse;"> <thead> <tr> <th></th> <th>#1</th> <th>#2</th> <th>#3</th> <th>#4</th> <th>#5</th> <th>#6</th> </tr> </thead> <tbody> <tr> <td>Weight of Wet Soils + Pan:</td> <td colspan="6" rowspan="6" style="background-color: yellow; text-align: center;">Unable to establish</td> </tr> <tr> <td>Weight of Dry Soils + Pan:</td> </tr> <tr> <td>Weight of Pan:</td> </tr> <tr> <td>Weight of Dry Soils:</td> </tr> <tr> <td>Weight of Moisture:</td> </tr> <tr> <td>% Moisture:</td> </tr> </tbody> </table>				#1	#2	#3	#4	#5	#6	Weight of Wet Soils + Pan:	Unable to establish						Weight of Dry Soils + Pan:	Weight of Pan:	Weight of Dry Soils:	Weight of Moisture:	% Moisture:							
	#1	#2	#3	#4	#5	#6																						
Weight of Wet Soils + Pan:	Unable to establish																											
Weight of Dry Soils + Pan:																												
Weight of Pan:																												
Weight of Dry Soils:																												
Weight of Moisture:																												
% Moisture:																												
<p style="font-size: small;">Copyright Spears Engineering &amp; Technical Services PS, 1996-98</p>																												

All results apply only to actual locations and materials tested. As a mutual protection to clients, the public and ourselves, all reports are submitted as the confidential property of clients, and authorization for publication of statements, conclusions or extracts from or regarding our reports is reserved pending our written approval.

**Comments:** Liquid limit cannot be determined as the material displays rapid dilation. At lower moistures the sample does not spread into the cup without tearing the soil cake. Unable to establish plastic limit as the material does not roll down to 1/8" threads before cracking or crumbling. Non-plastic.

Reviewed by:   
 Meghan Blodgett-Carrillo

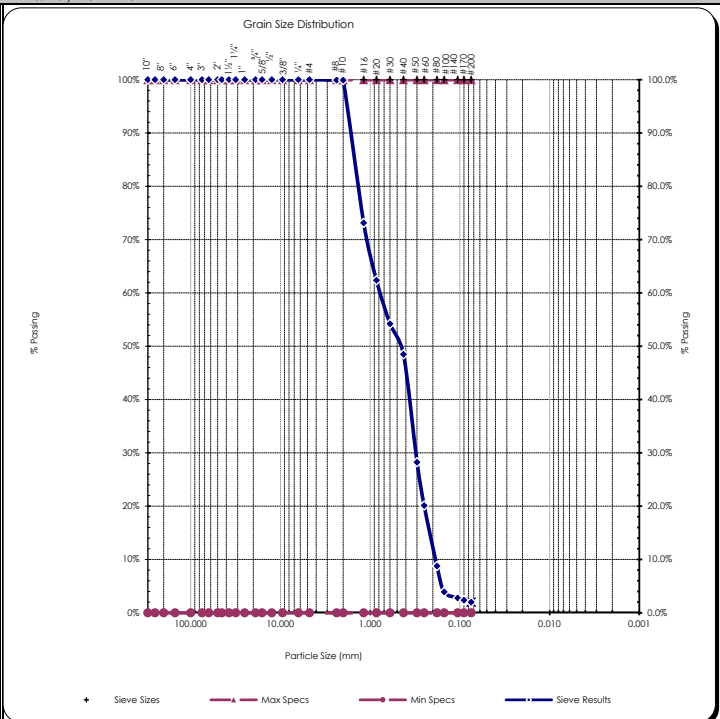


# Sieve Report

<b>Project:</b> Q.C. - Lower Duwamish Waterway <b>Project #:</b> 21B233 <b>Client:</b> Anchor QEA <b>Source:</b> LDW21-GT39-GB-8.8-10.5 ft <b>Sample#:</b> B21-1950	<b>Date Received:</b> 29-Jul-21 <b>Sampled By:</b> Client <b>Date Tested:</b> 4-Oct-21 <b>Tested By:</b> K. Mendez	<b>Unified Soil Classification System, ASTM-2487</b> SP, Poorly graded Sand <b>Sample Color:</b> grayish-brown	 <b>ACCREDITED</b> Certificate #: 1366.01
---	---	---	---

<b>ASTM D2216, ASTM D2419, ASTM D4318, ASTM D5281</b>			
<b>Specifications</b> No Specs <b>Sample Meets Specs ?</b> N/A	D <sub>(5)</sub> = 0.157 mm D <sub>(10)</sub> = 0.187 mm D <sub>(15)</sub> = 0.218 mm D <sub>(30)</sub> = 0.311 mm D <sub>(50)</sub> = 0.471 mm D <sub>(60)</sub> = 0.777 mm D <sub>(90)</sub> = 1.696 mm Dust Ratio = 1/24	% Gravel = 0.0% % Sand = 98.0% % Silt & Clay = 2.0% Liquid Limit = n/a Plasticity Index = n/a Sand Equivalent = n/a Fracture %, 1 Face = n/a Fracture %, 2+ Faces = n/a	Coeff. of Curvature, C <sub>c</sub> = 0.66 Coeff. of Uniformity, C <sub>u</sub> = 4.15 Fineness Modulus = 2.40 Plastic Limit = n/a Moisture %, as sampled = 25.0% Req'd Sand Equivalent = Req'd Fracture %, 1 Face = Req'd Fracture %, 2+ Faces =

<b>ASTM C136, ASTM D6913, ASTM C117</b>					
<b>Sieve Size</b>		<b>Actual Cumulative Percent Passing</b>	<b>Interpolated Cumulative Percent Passing</b>	<b>Specs Max</b>	<b>Specs Min</b>
<b>US</b>	<b>Metric</b>				
12.00"	300.00		100%	100.0%	0.0%
10.00"	250.00		100%	100.0%	0.0%
8.00"	200.00		100%	100.0%	0.0%
6.00"	150.00		100%	100.0%	0.0%
4.00"	100.00		100%	100.0%	0.0%
3.00"	75.00		100%	100.0%	0.0%
2.50"	63.00		100%	100.0%	0.0%
2.00"	50.00	100%	100%	100.0%	0.0%
1.75"	45.00	100%	100%	100.0%	0.0%
1.50"	37.50	100%	100%	100.0%	0.0%
1.25"	31.50	100%	100%	100.0%	0.0%
1.00"	25.00	100%	100%	100.0%	0.0%
3/4"	19.00	100%	100%	100.0%	0.0%
5/8"	16.00	100%	100%	100.0%	0.0%
1/2"	12.50	100%	100%	100.0%	0.0%
3/8"	9.50	100%	100%	100.0%	0.0%
1/4"	6.30	100%	100%	100.0%	0.0%
#4	4.75	100%	100%	100.0%	0.0%
#8	2.36	100%	100%	100.0%	0.0%
#10	2.00	100%	100%	100.0%	0.0%
#16	1.18		73%	100.0%	0.0%
#20	0.850		62%	100.0%	0.0%
#30	0.600		54%	100.0%	0.0%
#40	0.425	49%	49%	100.0%	0.0%
#50	0.300		28%	100.0%	0.0%
#60	0.250		20%	100.0%	0.0%
#80	0.180		9%	100.0%	0.0%
#100	0.150	4%	4%	100.0%	0.0%
#140	0.106		3%	100.0%	0.0%
#170	0.090		2%	100.0%	0.0%
#200	0.075	2.0%	2.0%	100.0%	0.0%



Copyright Spears Engineering & Technical Services PS, 1996-98  
 All results apply only to actual locations and materials tested. As a mutual protection to clients, the public and ourselves, all reports are submitted as the confidential property of clients, and authorization for publication of statements, conclusions or extracts from or regarding our reports is reserved pending our written approval.

**Comments:** \_\_\_\_\_

Reviewed by:   
 Meghan Blodgett-Carrillo

# Sieve Report

<b>Project:</b> Q.C. - Lower Duwamish Waterway <b>Project #:</b> 21B233 <b>Client:</b> Anchor QEA <b>Source:</b> LDW21-GT39-GB-10.5-20.5 ft <b>Sample#:</b> B21-1952	<b>Date Received:</b> 29-Jul-21 <b>Sampled By:</b> Client <b>Date Tested:</b> 4-Oct-21 <b>Tested By:</b> K. Mendez	<b>Unified Soil Classification System, ASTM-2487</b> SP-SM, Poorly graded Sand with Silt <b>Sample Color:</b> grayish-brown	 Certificate #: 1366.01
--	---	--	----------------------------

**ASTM D2216, ASTM D2419, ASTM D4318, ASTM D5281**

**Specifications**

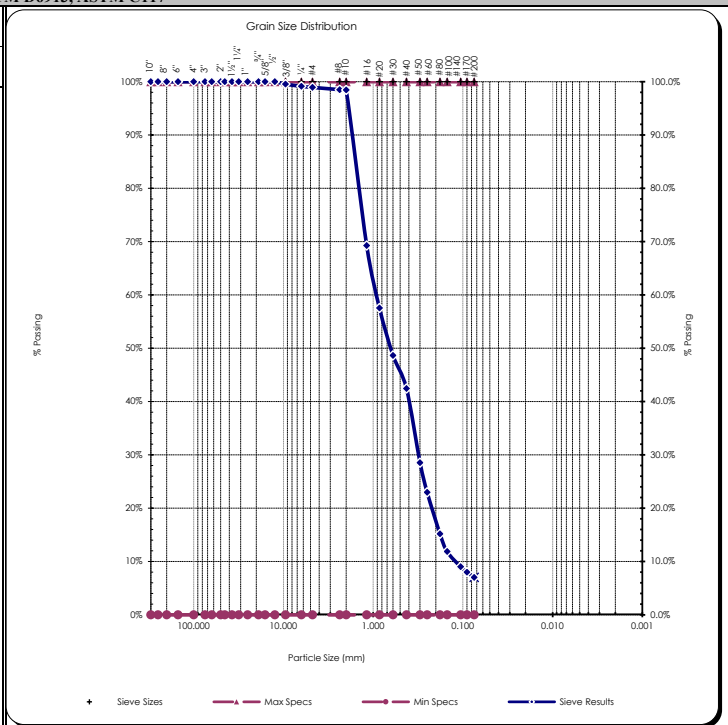
No Specs

Sample Meets Specs ? N/A

D <sub>(5)</sub> = 0.053 mm	% Gravel = 1.1%	Coeff. of Curvature, C <sub>c</sub> = 0.88
D <sub>(10)</sub> = 0.121 mm	% Sand = 91.9%	Coeff. of Uniformity, C <sub>u</sub> = 7.60
D <sub>(15)</sub> = 0.178 mm	% Silt & Clay = 7.0%	Fineness Modulus = 2.45
D <sub>(30)</sub> = 0.313 mm	Liquid Limit = n/a	Plastic Limit = n/a
D <sub>(50)</sub> = 0.638 mm	Plasticity Index = n/a	Moisture %, as sampled = 19.2%
D <sub>(60)</sub> = 0.919 mm	Sand Equivalent = n/a	Req'd Sand Equivalent =
D <sub>(90)</sub> = 1.762 mm	Fracture %, 1 Face = n/a	Req'd Fracture %, 1 Face =
Dust Ratio = 1/6	Fracture %, 2+ Faces = n/a	Req'd Fracture %, 2+ Faces =

**ASTM C136, ASTM D6913, ASTM C117**

Sieve Size		Actual Cumulative Percent Passing	Interpolated Cumulative Percent Passing	Specs Max	Specs Min
US	Metric				
12.00"	300.00		100%	100.0%	0.0%
10.00"	250.00		100%	100.0%	0.0%
8.00"	200.00		100%	100.0%	0.0%
6.00"	150.00		100%	100.0%	0.0%
4.00"	100.00		100%	100.0%	0.0%
3.00"	75.00		100%	100.0%	0.0%
2.50"	63.00		100%	100.0%	0.0%
2.00"	50.00	100%	100%	100.0%	0.0%
1.75"	45.00		100%	100.0%	0.0%
1.50"	37.50		100%	100.0%	0.0%
1.25"	31.50		100%	100.0%	0.0%
1.00"	25.00	100%	100%	100.0%	0.0%
3/4"	19.00	100%	100%	100.0%	0.0%
5/8"	16.00		100%	100.0%	0.0%
1/2"	12.50	100%	100%	100.0%	0.0%
3/8"	9.50	100%	100%	100.0%	0.0%
1/4"	6.30		99%	100.0%	0.0%
#4	4.75	99%	99%	100.0%	0.0%
#8	2.36		99%	100.0%	0.0%
#10	2.00	98%	98%	100.0%	0.0%
#16	1.18		69%	100.0%	0.0%
#20	0.850		58%	100.0%	0.0%
#30	0.600		49%	100.0%	0.0%
#40	0.425	42%	42%	100.0%	0.0%
#50	0.300		29%	100.0%	0.0%
#60	0.250		23%	100.0%	0.0%
#80	0.180		15%	100.0%	0.0%
#100	0.150	12%	12%	100.0%	0.0%
#140	0.106		9%	100.0%	0.0%
#170	0.090		8%	100.0%	0.0%
#200	0.075	7.0%	7.0%	100.0%	0.0%



Copyright Spears Engineering & Technical Services PS, 1996-98

All results apply only to actual locations and materials tested. As a mutual protection to clients, the public and ourselves, all reports are submitted as the confidential property of clients, and authorization for publication of statements, conclusions or extracts from or regarding our reports is reserved pending our written approval.

**Comments:**

Reviewed by:   
 Meghan Blodgett-Carrillo

# Direct Shear Test Results:

ASTM D-3080



Project: Q.C. - Lower Duwamish Waterway  
 Project Number: 21B233  
 Laboratory Sample ID: B21-1952  
 Sample Date: 7/16/2021  
 Test Date: 10/4/2021  
 Technician: M. Carrillo

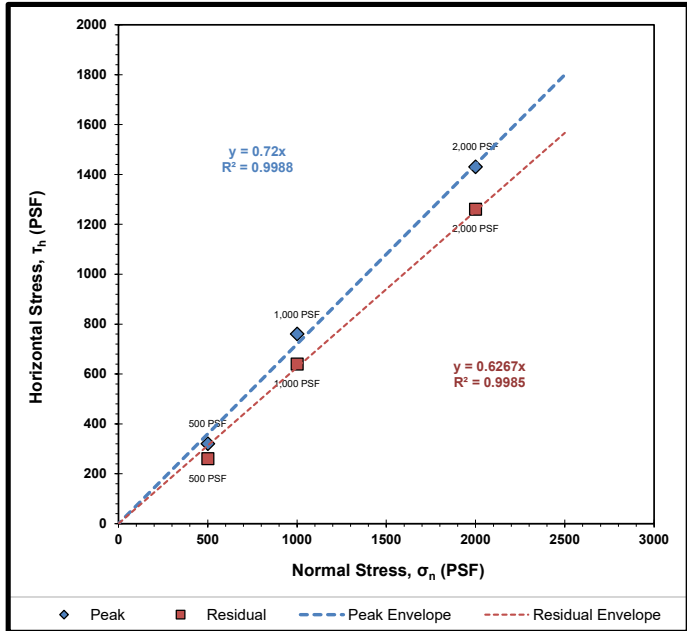
Sample Source: LDW21-GT39-GB-10.5-20.5 ft  
 Visual Soil Description: grayish-brown sand  
 Type of Specimen: Remolded Cylindrical Shear Box  
 Specimen Diameter (in): 2.5  
 Specimen Height (in): 1  
 Rate of Strain (in/min): 0.0208  
 Estimated Specific Gravity of Solids: 2.65

Summary of Sample Data: $\sigma_n=500$ PSF		
Initial Moisture Content (%)	26.0	
	Initial	Post-Consolidation
Dry Density (PCF):	109.4	111.1
Void Ratio:	0.540	0.516
Porosity (%):	35.1	34.0
Degree of Saturation (%):	saturated	saturated

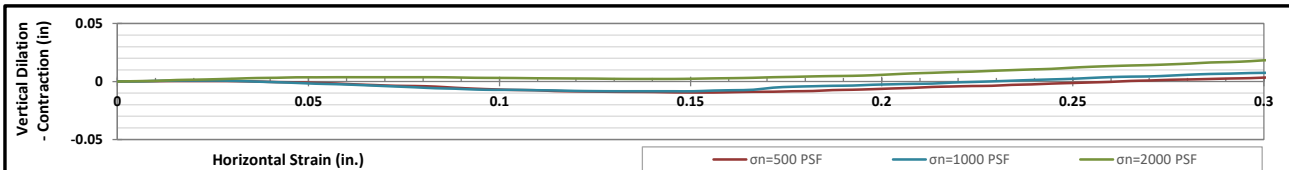
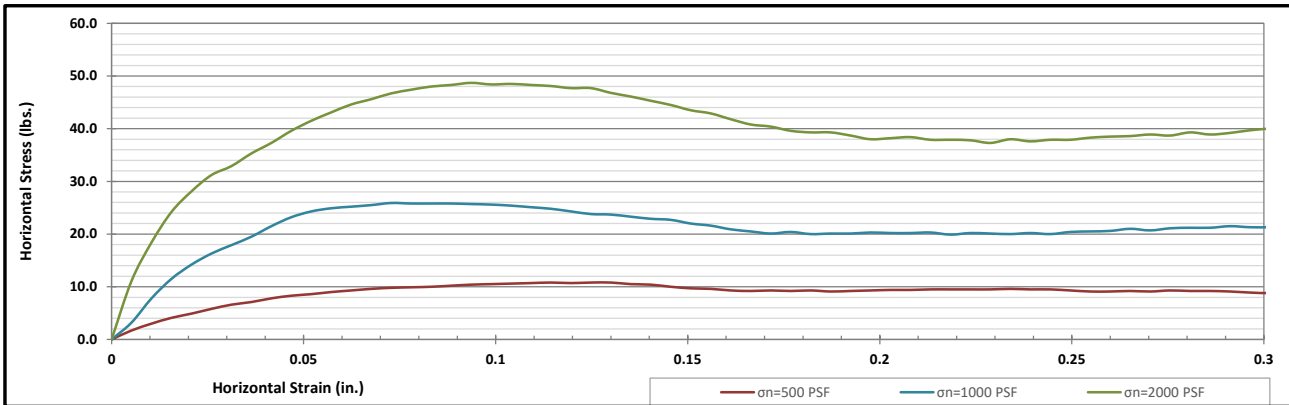
Summary of Sample Data: $\sigma_n=1000$ PSF		
Initial Moisture Content (%)	26.7	
	Initial	Post-Consolidation
Dry Density (PCF):	107.4	109.6
Void Ratio:	0.569	0.537
Porosity (%):	36.3	34.9
Degree of Saturation (%):	saturated	saturated

Summary of Sample Data: $\sigma_n=2000$ PSF		
Initial Moisture Content (%)	25.2	
	Initial	Post-Consolidation
Dry Density (PCF):	109.0	113.2
Void Ratio:	0.546	0.488
Porosity (%):	35.3	32.8
Degree of Saturation (%):	saturated	saturated

ESTIMATED STRENGTH PARAMETERS		
	PEAK	RESIDUAL
Angle of Internal Friction, $\phi$ (°):	36	32
Cohesion (PSF):	0	0



Failure Envelope Test Values:			
Normal Stress, $\sigma_n$ (PSF):	500	1000	2000
Peak Horizontal Stress, $\tau_h$ (PSF):	320	760	1430
Residual Horizontal Stress, $\tau_r$ (PSF):	260	640	1260



Corporate • 777 Chrysler Drive • Burlington, WA 98233 • Phone 360.755.1990 • Fax 360.755.1980  
 SW Region • 2118 Black Lake Blvd. S.W. • Olympia, WA 98512 • Phone 360.534.9777 • Fax 360.534.9779  
 NW Region • 805 Dupont, Suite #5 • Bellingham, WA 98225 • Phone 360.647.6061 • Fax 360.647.8111  
 Kitsap Region • 5451 N.W. Newberry Hill Road, Suite 101 • Silverdale, WA 98383 • Phone/Fax 360.698.6787

Visit our website: [www.mtc-inc.net](http://www.mtc-inc.net)

# Sieve Report

<b>Project:</b> Q.C. - Lower Duwamish Waterway <b>Project #:</b> 21B233 <b>Client:</b> Anchor QEA <b>Source:</b> LDW21-GT39-GB-20.5-30.5 ft <b>Sample#:</b> B21-1954	<b>Date Received:</b> 29-Jul-21 <b>Sampled By:</b> Client <b>Date Tested:</b> 4-Oct-21 <b>Tested By:</b> K. Mendez	<b>Unified Soil Classification System, ASTM-2487</b> SP, Poorly graded Sand <b>Sample Color:</b> gray	 Certificate #: 1366.01
--	---	--	----------------------------

ASTM D2216, ASTM D2419, ASTM D4318, ASTM D5281

**Specifications**

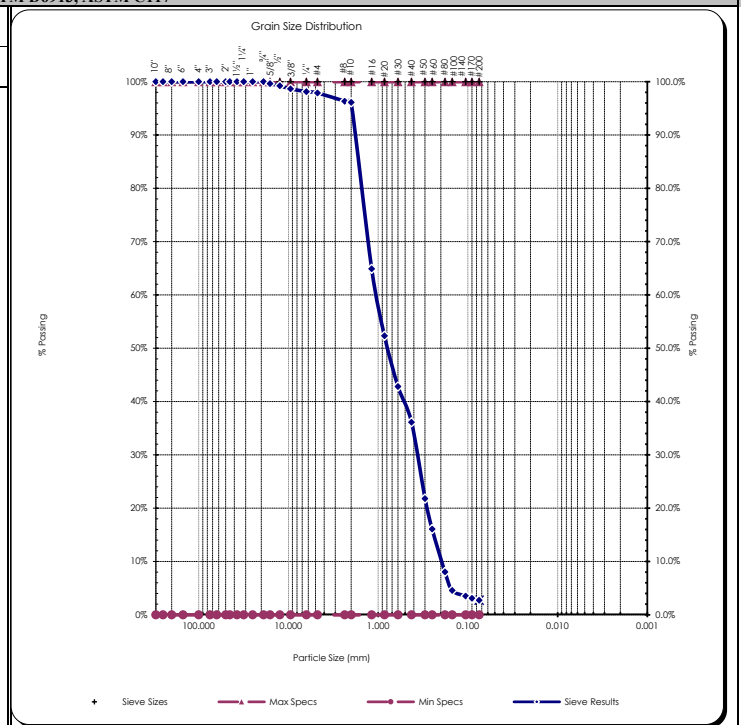
No Specs

Sample Meets Specs ? N/A

$D_{(5)} = 0.153$ mm $D_{(10)} = 0.197$ mm $D_{(15)} = 0.241$ mm $D_{(30)} = 0.371$ mm $D_{(50)} = 0.789$ mm $D_{(60)} = 1.051$ mm $D_{(90)} = 1.839$ mm Dust Ratio = 1/13	% Gravel = 2.1% % Sand = 95.1% % Silt & Clay = 2.8% Liquid Limit = n/a Plasticity Index = n/a Sand Equivalent = n/a Fracture %, 1 Face = n/a Fracture %, 2+ Faces = n/a	Coeff. of Curvature, $C_c = 0.67$ Coeff. of Uniformity, $C_u = 5.34$ Fineness Modulus = 2.73 Plastic Limit = n/a Moisture %, as sampled = 19.5% Req'd Sand Equivalent = Req'd Fracture %, 1 Face = Req'd Fracture %, 2+ Faces =
---	--	--

ASTM C136, ASTM D6913, ASTM C117

Sieve Size		Actual Cumulative Percent Passing	Interpolated Cumulative Percent Passing	Specs Max	Specs Min
US	Metric				
12.00"	300.00		100%	100.0%	0.0%
10.00"	250.00		100%	100.0%	0.0%
8.00"	200.00		100%	100.0%	0.0%
6.00"	150.00		100%	100.0%	0.0%
4.00"	100.00		100%	100.0%	0.0%
3.00"	75.00		100%	100.0%	0.0%
2.50"	63.00		100%	100.0%	0.0%
2.00"	50.00	100%	100%	100.0%	0.0%
1.75"	45.00		100%	100.0%	0.0%
1.50"	37.50		100%	100.0%	0.0%
1.25"	31.50		100%	100.0%	0.0%
1.00"	25.00	100%	100%	100.0%	0.0%
3/4"	19.00	100%	100%	100.0%	0.0%
5/8"	16.00		100%	100.0%	0.0%
1/2"	12.50	99%	99%	100.0%	0.0%
3/8"	9.50	99%	99%	100.0%	0.0%
1/4"	6.30		98%	100.0%	0.0%
#4	4.75	98%	98%	100.0%	0.0%
#8	2.36		96%	100.0%	0.0%
#10	2.00	96%	96%	100.0%	0.0%
#16	1.18		65%	100.0%	0.0%
#20	0.850		52%	100.0%	0.0%
#30	0.600		43%	100.0%	0.0%
#40	0.425	36%	36%	100.0%	0.0%
#50	0.300		22%	100.0%	0.0%
#60	0.250		16%	100.0%	0.0%
#80	0.180		8%	100.0%	0.0%
#100	0.150	5%	5%	100.0%	0.0%
#140	0.106		4%	100.0%	0.0%
#170	0.090		3%	100.0%	0.0%
#200	0.075	2.8%	2.8%	100.0%	0.0%



Copyright Spears Engineering & Technical Services PS, 1996-98

All results apply only to actual locations and materials tested. As a mutual protection to clients, the public and ourselves, all reports are submitted as the confidential property of clients, and authorization for publication of statements, conclusions or extracts from or regarding our reports is reserved pending our written approval.

**Comments:**

Reviewed by:   
 Meghan Blodgett-Carrillo

# Materials Testing & Consulting, Inc.

Geotechnical Engineering • Special Inspections • Materials Testing • Environmental Consulting



## ASTM D4318 - Liquid Limit, Plastic Limit and Plasticity Index of Soils

<b>Project:</b> Q.C. - Lower Duwamish Waterway <b>Project #:</b> 21B233 <b>Client:</b> Anchor QEA, LLC <b>Source:</b> LDW21-GT23-GB-0-8.2 ft <b>Sample #:</b> B21-1957	<b>Date Received:</b> 29-Jul-21 <b>Sampled By:</b> Client <b>Date Tested:</b> 6-Oct-21 <b>Tested By:</b> C. Kriss	<b>Visual Identification</b> Silt with Sand <b>Sample Color</b> brown
--	--	--

Liquid Limit Determination						
	#1	#2	#3	#4	#5	#6
Weight of Wet Soils + Pan:	33.87	31.07	35.40			
Weight of Dry Soils + Pan:	29.74	27.66	30.53			
Weight of Pan:	19.98	19.72	19.51			
Weight of Dry Soils:	9.76	7.94	11.02			
Weight of Moisture:	4.13	3.41	4.87			
% Moisture:	42.3 %	43.0 %	44.2 %			
Number of Blows:	25	20	13			


Plastic Limit Determination						
	#1	#2	#3	#4	#5	#6
Weight of Wet Soils + Pan:						
Weight of Dry Soils + Pan:	Unable to establish					
Weight of Pan:						
Weight of Dry Soils:						
Weight of Moisture:						
% Moisture:						

**Liquid Limit @ 25 Blows:** 42 %

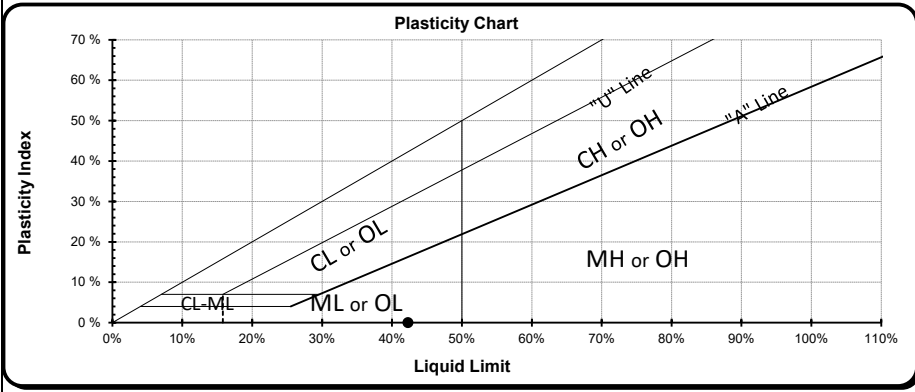
**Plastic Limit:** N/A

**Plasticity Index, I<sub>p</sub>:** N/A

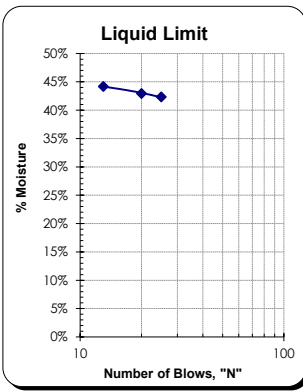


ACCREDITED  
Certificate #: 1366.01, 1366.02 & 1366.04



Copyright Spears Engineering & Technical Services PS, 1996-98



All results apply only to actual locations and materials tested. As a mutual protection to clients, the public and ourselves, all reports are submitted as the confidential property of clients, and authorization for publication of statements, conclusions or extracts from or regarding our reports is reserved pending our written approval.

**Comments:** Unable to establish plastic limit as the material does not roll down to 1/8" threads before cracking or crumbling. Non-plastic.

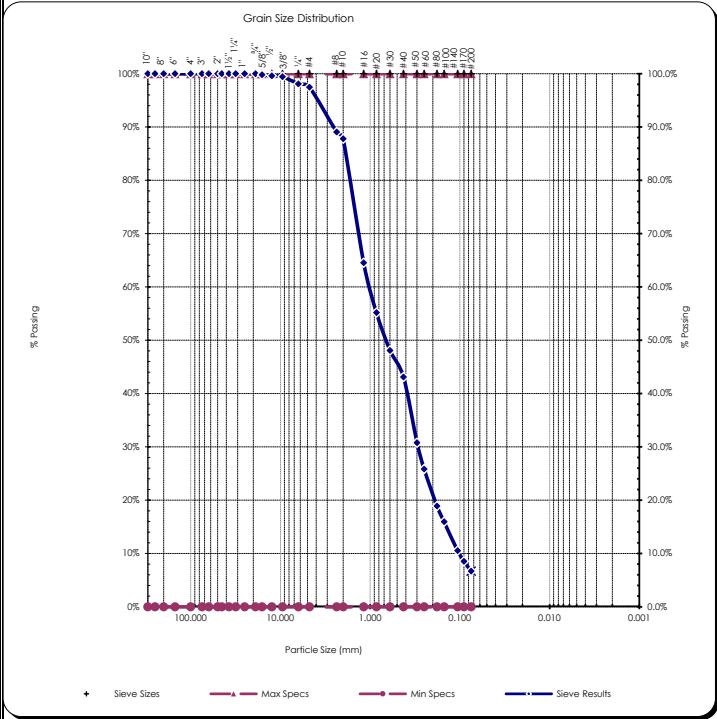
Reviewed by:   
 Meghan Blodgett-Carrillo

# Sieve Report

<b>Project:</b> Q.C. - Lower Duwamish Waterway <b>Project #:</b> 21B233 <b>Client:</b> Anchor QEA <b>Source:</b> LDW21-GT23-GB-8.5-17.6 ft <b>Sample#:</b> B21-1959	<b>Date Received:</b> 29-Jul-21 <b>Sampled By:</b> Client <b>Date Tested:</b> 4-Oct-21 <b>Tested By:</b> K. Mendez	<b>Unified Soil Classification System, ASTM-2487</b> SP-SM, Poorly graded Sand with Silt <b>Sample Color:</b> grayish-brown	 <b>ACCREDITED</b> Certificate #: 1366.01
---	---	--	---

<b>ASTM D2216, ASTM D2419, ASTM D4318, ASTM D5281</b>			
<b>Specifications</b> No Specs <b>Sample Meets Specs ?</b> N/A	D <sub>(5)</sub> = 0.056 mm D <sub>(10)</sub> = 0.102 mm D <sub>(15)</sub> = 0.142 mm D <sub>(30)</sub> = 0.292 mm D <sub>(50)</sub> = 0.667 mm D <sub>(60)</sub> = 1.020 mm D <sub>(90)</sub> = 2.624 mm Dust Ratio = 7/45	% Gravel = 2.5% % Sand = 90.8% % Silt & Clay = 6.7% Liquid Limit = n/a Plasticity Index = n/a Sand Equivalent = n/a Fracture %, 1 Face = n/a Fracture %, 2+ Faces = n/a	Coeff. of Curvature, C <sub>c</sub> = 0.82 Coeff. of Uniformity, C <sub>u</sub> = 10.03 Fineness Modulus = 2.55 Plastic Limit = n/a Moisture %, as sampled = 18.0% Req'd Sand Equivalent = Req'd Fracture %, 1 Face = Req'd Fracture %, 2+ Faces =

<b>ASTM C136, ASTM D6913, ASTM C117</b>					
<b>Sieve Size</b>		<b>Actual Cumulative Percent Passing</b>	<b>Interpolated Cumulative Percent Passing</b>	<b>Specs Max</b>	<b>Specs Min</b>
<b>US</b>	<b>Metric</b>				
12.00"	300.00		100%	100.0%	0.0%
10.00"	250.00		100%	100.0%	0.0%
8.00"	200.00		100%	100.0%	0.0%
6.00"	150.00		100%	100.0%	0.0%
4.00"	100.00		100%	100.0%	0.0%
3.00"	75.00		100%	100.0%	0.0%
2.50"	63.00		100%	100.0%	0.0%
2.00"	50.00	100%	100%	100.0%	0.0%
1.75"	45.00	100%	100%	100.0%	0.0%
1.50"	37.50	100%	100%	100.0%	0.0%
1.25"	31.50	100%	100%	100.0%	0.0%
1.00"	25.00	100%	100%	100.0%	0.0%
3/4"	19.00	100%	100%	100.0%	0.0%
5/8"	16.00	100%	100%	100.0%	0.0%
1/2"	12.50	100%	100%	100.0%	0.0%
3/8"	9.50	99%	99%	100.0%	0.0%
1/4"	6.30	98%	98%	100.0%	0.0%
#4	4.75	97%	97%	100.0%	0.0%
#8	2.36	89%	89%	100.0%	0.0%
#10	2.00	88%	88%	100.0%	0.0%
#16	1.18	65%	65%	100.0%	0.0%
#20	0.850	55%	55%	100.0%	0.0%
#30	0.600	48%	48%	100.0%	0.0%
#40	0.425	43%	43%	100.0%	0.0%
#50	0.300	31%	31%	100.0%	0.0%
#60	0.250	26%	26%	100.0%	0.0%
#80	0.180	19%	19%	100.0%	0.0%
#100	0.150	16%	16%	100.0%	0.0%
#140	0.106	11%	11%	100.0%	0.0%
#170	0.090	9%	9%	100.0%	0.0%
#200	0.075	6.7%	6.7%	100.0%	0.0%



Copyright Spears Engineering & Technical Services PS, 1996-98  
 All results apply only to actual locations and materials tested. As a mutual protection to clients, the public and ourselves, all reports are submitted as the confidential property of clients, and authorization for publication of statements, conclusions or extracts from or regarding our reports is reserved pending our written approval.

**Comments:** \_\_\_\_\_

Reviewed by:   
 Meghan Blodgett-Carrillo

# Direct Shear Test Results:

ASTM D-3080



Project: Q.C. - Lower Duwamish Waterway  
 Project Number: 21B233  
 Laboratory Sample ID: B21-1959  
 Sample Date: 7/16/2021  
 Test Date: 10/5/2021  
 Technician: M. Carrillo

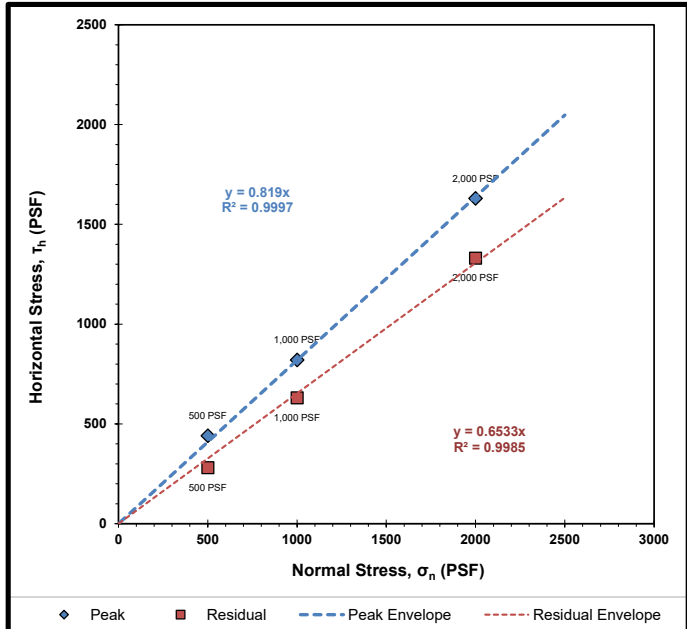
Sample Source: LDW21-GT23-GB-8.5-17.6 ft  
 Visual Soil Description: grayish-brown sand  
 Type of Specimen: Remolded Cylindrical Shear Box  
 Specimen Diameter (in): 2.5  
 Specimen Height (in): 1  
 Rate of Strain (in/min): 0.0208  
 Estimated Specific Gravity of Solids: 2.65

Summary of Sample Data: $\sigma_n=500$ PSF		
Initial Moisture Content (%)	22.6	
	Initial	Post-Consolidation
Dry Density (PCF):	109.4	111.1
Void Ratio:	0.539	0.517
Porosity (%):	35.0	34.1
Degree of Saturation (%):	saturated	saturated

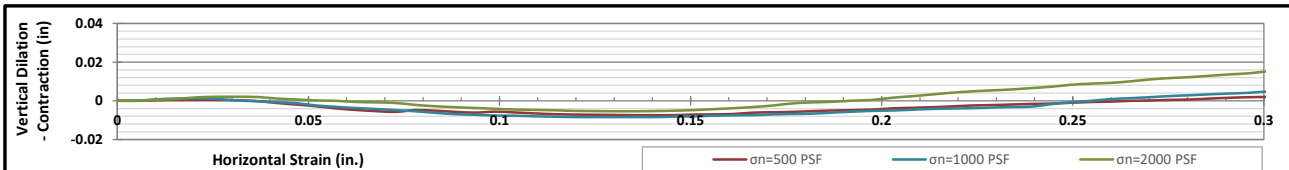
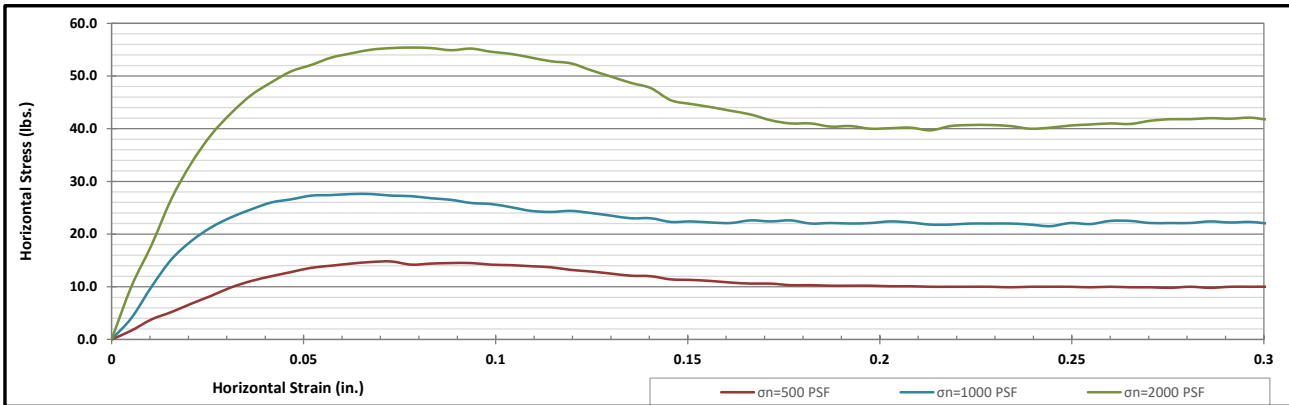
Summary of Sample Data: $\sigma_n=1000$ PSF		
Initial Moisture Content (%)	22.2	
	Initial	Post-Consolidation
Dry Density (PCF):	110.1	111.8
Void Ratio:	0.531	0.507
Porosity (%):	34.7	33.7
Degree of Saturation (%):	saturated	saturated

Summary of Sample Data: $\sigma_n=2000$ PSF		
Initial Moisture Content (%)	23.3	
	Initial	Post-Consolidation
Dry Density (PCF):	109.0	114.1
Void Ratio:	0.545	0.476
Porosity (%):	35.3	32.3
Degree of Saturation (%):	saturated	saturated

ESTIMATED STRENGTH PARAMETERS		
	PEAK	RESIDUAL
Angle of Internal Friction, $\phi$ (°):	39	33
Cohesion (PSF):	0	0



Failure Envelope Test Values:			
Normal Stress, $\sigma_n$ (PSF):	500	1000	2000
Peak Horizontal Stress, $\tau_h$ (PSF):	440	820	1630
Residual Horizontal Stress, $\tau_r$ (PSF):	280	630	1330



Corporate • 777 Chrysler Drive • Burlington, WA 98233 • Phone 360.755.1990 • Fax 360.755.1980  
 SW Region • 2118 Black Lake Blvd. S.W. • Olympia, WA 98512 • Phone 360.534.9777 • Fax 360.534.9779  
 NW Region • 805 Dupont, Suite #5 • Bellingham, WA 98225 • Phone 360.647.6061 • Fax 360.647.8111  
 Kitsap Region • 5451 N.W. Newberry Hill Road, Suite 101 • Silverdale, WA 98383 • Phone/Fax 360.698.6787

Visit our website: [www.mtc-inc.net](http://www.mtc-inc.net)

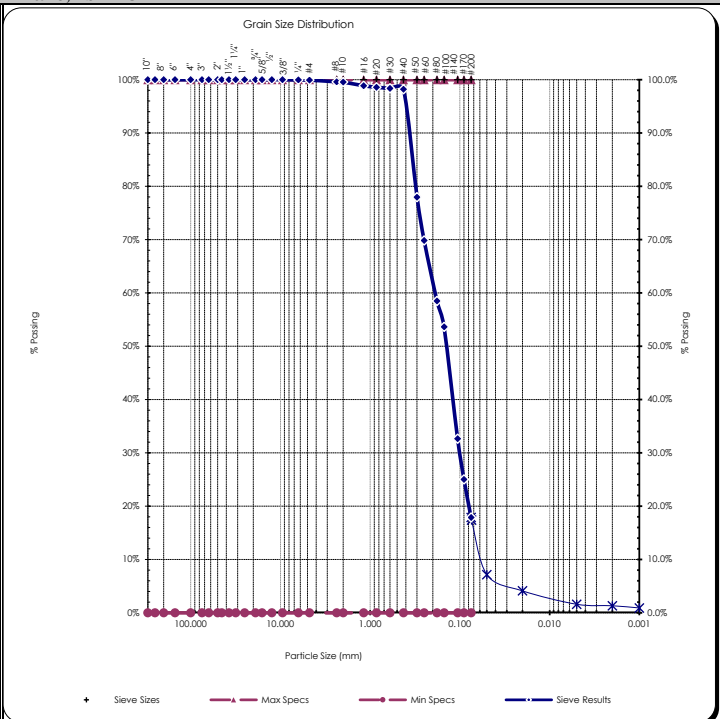


# Sieve Report

<b>Project:</b> Q.C. - Lower Duwamish Waterway <b>Project #:</b> 21B233 <b>Client:</b> Anchor QEA <b>Source:</b> LDW21-GT23-GB-17.6-18.5 ft <b>Sample#:</b> B21-1960	<b>Date Received:</b> 29-Jul-21 <b>Sampled By:</b> Client <b>Date Tested:</b> 4-Oct-21 <b>Tested By:</b> K. Mendez	<b>Unified Soil Classification System, ASTM-2487</b> SM, Silty Sand <b>Sample Color:</b> grayish-brown	 <b>ACCREDITED</b> Certificate #: 1366.01
--	---	---	---

<b>ASTM D2216, ASTM D2419, ASTM D4318, ASTM D5281</b>			
<b>Specifications</b> No Specs <b>Sample Meets Specs ? N/A</b>	D <sub>(5)</sub> = 0.028 mm D <sub>(10)</sub> = 0.059 mm D <sub>(15)</sub> = 0.069 mm D <sub>(30)</sub> = 0.100 mm D <sub>(50)</sub> = 0.142 mm D <sub>(60)</sub> = 0.189 mm D <sub>(90)</sub> = 0.374 mm Dust Ratio = 2/11	% Gravel = 0.1% % Sand = 82.0% % Silt & Clay = 17.9% Liquid Limit = n/a Plasticity Index = n/a Sand Equivalent = n/a Fracture %, 1 Face = n/a Fracture %, 2+ Faces = n/a	Coeff. of Curvature, C <sub>c</sub> = 0.90 Coeff. of Uniformity, C <sub>u</sub> = 3.20 Fineness Modulus = 0.72 Plastic Limit = n/a Moisture %, as sampled = 36.2% Req'd Sand Equivalent = Req'd Fracture %, 1 Face = Req'd Fracture %, 2+ Faces =

<b>ASTM C136, ASTM D6913, ASTM C117</b>					
Sieve Size		Actual Cumulative Percent Passing	Interpolated Cumulative Percent Passing	Specs Max	Specs Min
US	Metric				
12.00"	300.00		100%	100.0%	0.0%
10.00"	250.00		100%	100.0%	0.0%
8.00"	200.00		100%	100.0%	0.0%
6.00"	150.00		100%	100.0%	0.0%
4.00"	100.00		100%	100.0%	0.0%
3.00"	75.00		100%	100.0%	0.0%
2.50"	63.00		100%	100.0%	0.0%
2.00"	50.00	100%	100%	100.0%	0.0%
1.75"	45.00		100%	100.0%	0.0%
1.50"	37.50		100%	100.0%	0.0%
1.25"	31.50		100%	100.0%	0.0%
1.00"	25.00	100%	100%	100.0%	0.0%
3/4"	19.00	100%	100%	100.0%	0.0%
5/8"	16.00		100%	100.0%	0.0%
1/2"	12.50	100%	100%	100.0%	0.0%
3/8"	9.50	100%	100%	100.0%	0.0%
1/4"	6.30		100%	100.0%	0.0%
#4	4.75	100%	100%	100.0%	0.0%
#8	2.36		100%	100.0%	0.0%
#10	2.00	100%	100%	100.0%	0.0%
#16	1.18		99%	100.0%	0.0%
#20	0.850		99%	100.0%	0.0%
#30	0.600		98%	100.0%	0.0%
#40	0.425	98%	98%	100.0%	0.0%
#50	0.300		78%	100.0%	0.0%
#60	0.250		70%	100.0%	0.0%
#80	0.180		59%	100.0%	0.0%
#100	0.150	54%	54%	100.0%	0.0%
#140	0.106		33%	100.0%	0.0%
#170	0.090		25%	100.0%	0.0%
#200	0.075	17.9%	17.9%	100.0%	0.0%



Copyright Spears Engineering & Technical Services PS, 1996-98  
 All results apply only to actual locations and materials tested. As a mutual protection to clients, the public and ourselves, all reports are submitted as the confidential property of clients, and authorization for publication of statements, conclusions or extracts from or regarding our reports is reserved pending our written approval.


**Comments:** \_\_\_\_\_

Reviewed by: *Meghan Blodgett-Carrillo*  
 Meghan Blodgett-Carrillo





## Hydrometer Report

<b>Project:</b> Q.C. - Lower Duwamish Waterway <b>Project #:</b> 21B233 <b>Client:</b> Anchor QEA <b>Source:</b> LDW21-GT23-GB-17.6-18.5 ft <b>Sample#:</b> B21-1960	<b>Date Received:</b> 29-Jul-21 <b>Sampled By:</b> Client <b>Date Tested:</b> 4-Oct-21 <b>Tested By:</b> K. Mendez	<b>Unified Soil Classification System, ASTM-2487</b> SM, Silty Sand <b>Sample Color</b> grayish-brown																																																																					
<b>ASTM D7928, HYDROMETER ANALYSIS</b>		<b>ASTM D6913</b>																																																																					
Assumed Sp Gr : 2.65 Sample Weight: 75.28 grams Hydroscopic Moist.: 1.16% Adj. Sample Wgt : 74.42 grams		<b>Sieve Analysis</b> <b>Grain Size Distribution</b>																																																																					
		<table border="1" style="width: 100%; border-collapse: collapse;"> <thead> <tr> <th>Sieve Size</th> <th>Percent Passing</th> <th>Soils Particle Diameter</th> </tr> </thead> <tbody> <tr><td>3.0"</td><td>100%</td><td>75.000 mm</td></tr> <tr><td>2.0"</td><td>100%</td><td>50.000 mm</td></tr> <tr><td>1.5"</td><td>100%</td><td>37.500 mm</td></tr> <tr><td>1.25"</td><td>100%</td><td>31.500 mm</td></tr> <tr><td>1.0"</td><td>100%</td><td>25.000 mm</td></tr> <tr><td>3/4"</td><td>100%</td><td>19.000 mm</td></tr> <tr><td>5/8"</td><td>100%</td><td>16.000 mm</td></tr> <tr><td>1/2"</td><td>100%</td><td>12.500 mm</td></tr> <tr><td>3/8"</td><td>100%</td><td>9.500 mm</td></tr> <tr><td>1/4"</td><td>100%</td><td>6.300 mm</td></tr> <tr><td>#4</td><td>100%</td><td>4.750 mm</td></tr> <tr><td>#10</td><td>100%</td><td>2.000 mm</td></tr> <tr><td>#20</td><td>99%</td><td>0.850 mm</td></tr> <tr><td>#40</td><td>98%</td><td>0.425 mm</td></tr> <tr><td>#100</td><td>54%</td><td>0.150 mm</td></tr> <tr><td>#200</td><td>17.9%</td><td>0.075 mm</td></tr> <tr><td><b>Silts</b></td><td>17.4%</td><td>0.074 mm</td></tr> <tr><td></td><td>7.2%</td><td>0.050 mm</td></tr> <tr><td></td><td>4.1%</td><td>0.020 mm</td></tr> <tr><td><b>Clays</b></td><td>1.6%</td><td>0.005 mm</td></tr> <tr><td></td><td>1.3%</td><td>0.002 mm</td></tr> <tr><td><b>Colloids</b></td><td>0.9%</td><td>0.001 mm</td></tr> </tbody> </table>	Sieve Size	Percent Passing	Soils Particle Diameter	3.0"	100%	75.000 mm	2.0"	100%	50.000 mm	1.5"	100%	37.500 mm	1.25"	100%	31.500 mm	1.0"	100%	25.000 mm	3/4"	100%	19.000 mm	5/8"	100%	16.000 mm	1/2"	100%	12.500 mm	3/8"	100%	9.500 mm	1/4"	100%	6.300 mm	#4	100%	4.750 mm	#10	100%	2.000 mm	#20	99%	0.850 mm	#40	98%	0.425 mm	#100	54%	0.150 mm	#200	17.9%	0.075 mm	<b>Silts</b>	17.4%	0.074 mm		7.2%	0.050 mm		4.1%	0.020 mm	<b>Clays</b>	1.6%	0.005 mm		1.3%	0.002 mm	<b>Colloids</b>	0.9%	0.001 mm
Sieve Size	Percent Passing	Soils Particle Diameter																																																																					
3.0"	100%	75.000 mm																																																																					
2.0"	100%	50.000 mm																																																																					
1.5"	100%	37.500 mm																																																																					
1.25"	100%	31.500 mm																																																																					
1.0"	100%	25.000 mm																																																																					
3/4"	100%	19.000 mm																																																																					
5/8"	100%	16.000 mm																																																																					
1/2"	100%	12.500 mm																																																																					
3/8"	100%	9.500 mm																																																																					
1/4"	100%	6.300 mm																																																																					
#4	100%	4.750 mm																																																																					
#10	100%	2.000 mm																																																																					
#20	99%	0.850 mm																																																																					
#40	98%	0.425 mm																																																																					
#100	54%	0.150 mm																																																																					
#200	17.9%	0.075 mm																																																																					
<b>Silts</b>	17.4%	0.074 mm																																																																					
	7.2%	0.050 mm																																																																					
	4.1%	0.020 mm																																																																					
<b>Clays</b>	1.6%	0.005 mm																																																																					
	1.3%	0.002 mm																																																																					
<b>Colloids</b>	0.9%	0.001 mm																																																																					
<table border="1" style="width: 100%; border-collapse: collapse;"> <thead> <tr> <th>Hydrometer Reading Minutes</th> <th>Corrected Reading</th> <th>Percent Passing</th> <th>Soils Particle Diameter</th> </tr> </thead> <tbody> <tr><td>1</td><td>5.5</td><td>7.4%</td><td>0.0537 mm</td></tr> <tr><td>2</td><td>4.5</td><td>6.0%</td><td>0.0381 mm</td></tr> <tr><td>5</td><td>3.5</td><td>4.7%</td><td>0.0243 mm</td></tr> <tr><td>15</td><td>2.5</td><td>3.3%</td><td>0.0141 mm</td></tr> <tr><td>30</td><td>2</td><td>2.7%</td><td>0.0100 mm</td></tr> <tr><td>60</td><td>1.5</td><td>2.0%</td><td>0.0071 mm</td></tr> <tr><td>240</td><td>1</td><td>1.3%</td><td>0.0035 mm</td></tr> <tr><td>1440</td><td>1</td><td>1.3%</td><td>0.0014 mm</td></tr> </tbody> </table>		Hydrometer Reading Minutes	Corrected Reading	Percent Passing	Soils Particle Diameter	1	5.5	7.4%	0.0537 mm	2	4.5	6.0%	0.0381 mm	5	3.5	4.7%	0.0243 mm	15	2.5	3.3%	0.0141 mm	30	2	2.7%	0.0100 mm	60	1.5	2.0%	0.0071 mm	240	1	1.3%	0.0035 mm	1440	1	1.3%	0.0014 mm																																		
Hydrometer Reading Minutes	Corrected Reading	Percent Passing	Soils Particle Diameter																																																																				
1	5.5	7.4%	0.0537 mm																																																																				
2	4.5	6.0%	0.0381 mm																																																																				
5	3.5	4.7%	0.0243 mm																																																																				
15	2.5	3.3%	0.0141 mm																																																																				
30	2	2.7%	0.0100 mm																																																																				
60	1.5	2.0%	0.0071 mm																																																																				
240	1	1.3%	0.0035 mm																																																																				
1440	1	1.3%	0.0014 mm																																																																				
% Gravel: 0.1% <b>Liquid Limit:</b> n/a % Sand: 82.0% <b>Plastic Limit:</b> n/a % Silt: 16.3% <b>Plasticity Index:</b> n/a % Clay: 1.6%																																																																							
<b>USDA Soil Textural Classification</b>																																																																							
<table border="1" style="width: 100%; border-collapse: collapse;"> <thead> <tr> <th></th> <th>Particle Size</th> </tr> </thead> <tbody> <tr><td>% Sand:</td><td>2.0 - 0.05 mm</td></tr> <tr><td>% Silt:</td><td>0.05 - 0.002 mm</td></tr> <tr><td>% Clay:</td><td>&lt; 0.002 mm</td></tr> </tbody> </table>			Particle Size	% Sand:	2.0 - 0.05 mm	% Silt:	0.05 - 0.002 mm	% Clay:	< 0.002 mm																																																														
	Particle Size																																																																						
% Sand:	2.0 - 0.05 mm																																																																						
% Silt:	0.05 - 0.002 mm																																																																						
% Clay:	< 0.002 mm																																																																						
<b>USDA Soil Textural Classification</b>																																																																							
Sand																																																																							

All results apply only to actual locations and materials tested. As a mutual protection to clients, the public and ourselves, all reports are submitted as the confidential property of clients, and authorization for publication of statements, conclusions or extracts from or regarding our reports is reserved pending our written approval.

**Comments:** \_\_\_\_\_

\_\_\_\_\_

\_\_\_\_\_

**Reviewed by:**  \_\_\_\_\_

Meghan Blodgett-Carrillo

# Materials Testing & Consulting, Inc.

Geotechnical Engineering • Special Inspections • Materials Testing • Environmental Consulting



## ASTM D4318 - Liquid Limit, Plastic Limit and Plasticity Index of Soils

<b>Project:</b> Q.C. - Lower Duwamish Waterway <b>Project #:</b> 21B233 <b>Client:</b> Anchor QEA, LLC <b>Source:</b> LDW21-GT23-GB-21.1-22.8 ft <b>Sample #:</b> B21-1962	<b>Date Received:</b> 29-Jul-21 <b>Sampled By:</b> Client <b>Date Tested:</b> 6-Oct-21 <b>Tested By:</b> C. Kriss	<b>Visual Identification</b> Sandy Silt <b>Sample Color</b> brown																										
<b>Liquid Limit Determination</b>																												
<table border="1" style="width: 100%; border-collapse: collapse;"> <thead> <tr> <th></th> <th>#1</th> <th>#2</th> <th>#3</th> <th>#4</th> <th>#5</th> <th>#6</th> </tr> </thead> <tbody> <tr> <td>Weight of Wet Soils + Pan:</td> <td colspan="6" rowspan="6" style="background-color: yellow; text-align: center;">Unable to determine</td> </tr> <tr> <td>Weight of Dry Soils + Pan:</td> </tr> <tr> <td>Weight of Pan:</td> </tr> <tr> <td>Weight of Dry Soils:</td> </tr> <tr> <td>Weight of Moisture:</td> </tr> <tr> <td>% Moisture:</td> </tr> <tr> <td>Number of Blows:</td> <td colspan="6" style="background-color: yellow;"></td> </tr> </tbody> </table>				#1	#2	#3	#4	#5	#6	Weight of Wet Soils + Pan:	Unable to determine						Weight of Dry Soils + Pan:	Weight of Pan:	Weight of Dry Soils:	Weight of Moisture:	% Moisture:	Number of Blows:						
	#1	#2	#3	#4	#5	#6																						
Weight of Wet Soils + Pan:	Unable to determine																											
Weight of Dry Soils + Pan:																												
Weight of Pan:																												
Weight of Dry Soils:																												
Weight of Moisture:																												
% Moisture:																												
Number of Blows:																												
<b>Liquid Limit @ 25 Blows:</b> N/A <b>Plastic Limit:</b> N/A <b>Plasticity Index, I<sub>p</sub>:</b> N/A																												
<b>Plastic Limit Determination</b>																												
<table border="1" style="width: 100%; border-collapse: collapse;"> <thead> <tr> <th></th> <th>#1</th> <th>#2</th> <th>#3</th> <th>#4</th> <th>#5</th> <th>#6</th> </tr> </thead> <tbody> <tr> <td>Weight of Wet Soils + Pan:</td> <td colspan="6" rowspan="6" style="background-color: yellow; text-align: center;">Unable to establish</td> </tr> <tr> <td>Weight of Dry Soils + Pan:</td> </tr> <tr> <td>Weight of Pan:</td> </tr> <tr> <td>Weight of Dry Soils:</td> </tr> <tr> <td>Weight of Moisture:</td> </tr> <tr> <td>% Moisture:</td> </tr> </tbody> </table>				#1	#2	#3	#4	#5	#6	Weight of Wet Soils + Pan:	Unable to establish						Weight of Dry Soils + Pan:	Weight of Pan:	Weight of Dry Soils:	Weight of Moisture:	% Moisture:							
	#1	#2	#3	#4	#5	#6																						
Weight of Wet Soils + Pan:	Unable to establish																											
Weight of Dry Soils + Pan:																												
Weight of Pan:																												
Weight of Dry Soils:																												
Weight of Moisture:																												
% Moisture:																												
<p style="font-size: small;">Copyright Spears Engineering &amp; Technical Services PS, 1996-98</p>																												

All results apply only to actual locations and materials tested. As a mutual protection to clients, the public and ourselves, all reports are submitted as the confidential property of clients, and authorization for publication of statements, conclusions or extracts from or regarding our reports is reserved pending our written approval.

**Comments:** Liquid limit cannot be determined as the material displays rapid dilation. At lower moistures the sample does not spread into the cup without tearing the soil cake. Unable to establish plastic limit as the material does not roll down to 1/8" threads before cracking or crumbling. Non-plastic.

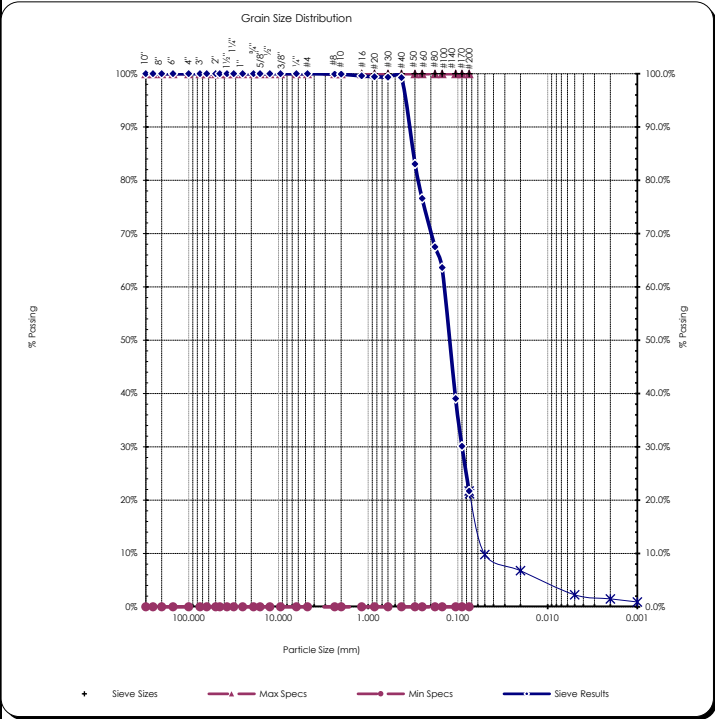
Reviewed by:   
 \_\_\_\_\_  
 Meghan Blodgett-Carrillo

# Sieve Report

<b>Project:</b> Q.C. - Lower Duwamish Waterway <b>Project #:</b> 21B233 <b>Client:</b> Anchor QEA <b>Source:</b> LDW21-GT23-GB-22.8-26.8 ft <b>Sample#:</b> B21-1963	<b>Date Received:</b> 29-Jul-21 <b>Sampled By:</b> Client <b>Date Tested:</b> 4-Oct-21 <b>Tested By:</b> K. Mendez	<b>Unified Soil Classification System, ASTM-2487</b> SM, Silty Sand <b>Sample Color:</b> brown	 <b>ACCREDITED</b> Certificate #: 1366.01
--	---	---	---

<b>ASTM D2216, ASTM D2419, ASTM D4318, ASTM D5281</b>			
<b>Specifications</b> No Specs <b>Sample Meets Specs ? N/A</b>	D <sub>(5)</sub> = 0.011 mm D <sub>(10)</sub> = 0.053 mm D <sub>(15)</sub> = 0.063 mm D <sub>(30)</sub> = 0.090 mm D <sub>(50)</sub> = 0.126 mm D <sub>(60)</sub> = 0.143 mm D <sub>(90)</sub> = 0.353 mm Dust Ratio = 7/32	% Gravel = 0.0% % Sand = 78.3% % Silt & Clay = 21.7% Liquid Limit = n/a Plasticity Index = n/a Sand Equivalent = n/a Fracture %, 1 Face = n/a Fracture %, 2+ Faces = n/a	Coeff. of Curvature, C <sub>c</sub> = 1.05 Coeff. of Uniformity, C <sub>u</sub> = 2.69 Fineness Modulus = 0.54 Plastic Limit = n/a Moisture %, as sampled = 32.1% Req'd Sand Equivalent = Req'd Fracture %, 1 Face = Req'd Fracture %, 2+ Faces =

<b>ASTM C136, ASTM D6913, ASTM C117</b>					
Sieve Size		Actual Cumulative Percent Passing	Interpolated Cumulative Percent Passing	Specs Max	Specs Min
US	Metric				
12.00"	300.00		100%	100.0%	0.0%
10.00"	250.00		100%	100.0%	0.0%
8.00"	200.00		100%	100.0%	0.0%
6.00"	150.00		100%	100.0%	0.0%
4.00"	100.00		100%	100.0%	0.0%
3.00"	75.00		100%	100.0%	0.0%
2.50"	63.00		100%	100.0%	0.0%
2.00"	50.00	100%	100%	100.0%	0.0%
1.75"	45.00	100%	100%	100.0%	0.0%
1.50"	37.50	100%	100%	100.0%	0.0%
1.25"	31.50	100%	100%	100.0%	0.0%
1.00"	25.00	100%	100%	100.0%	0.0%
3/4"	19.00	100%	100%	100.0%	0.0%
5/8"	16.00	100%	100%	100.0%	0.0%
1/2"	12.50	100%	100%	100.0%	0.0%
3/8"	9.50	100%	100%	100.0%	0.0%
1/4"	6.30	100%	100%	100.0%	0.0%
#4	4.75	100%	100%	100.0%	0.0%
#8	2.36	100%	100%	100.0%	0.0%
#10	2.00	100%	100%	100.0%	0.0%
#16	1.18	100%	100%	100.0%	0.0%
#20	0.850	99%	99%	100.0%	0.0%
#30	0.600	99%	99%	100.0%	0.0%
#40	0.425	99%	99%	100.0%	0.0%
#50	0.300	83%	83%	100.0%	0.0%
#60	0.250	77%	77%	100.0%	0.0%
#80	0.180	68%	68%	100.0%	0.0%
#100	0.150	64%	64%	100.0%	0.0%
#140	0.106	39%	39%	100.0%	0.0%
#170	0.090	30%	30%	100.0%	0.0%
#200	0.075	21.7%	21.7%	100.0%	0.0%



Copyright Spears Engineering & Technical Services PS, 1996-98  
 All results apply only to actual locations and materials tested. As a mutual protection to clients, the public and ourselves, all reports are submitted as the confidential property of clients, and authorization for publication of statements, conclusions or extracts from or regarding our reports is reserved pending our written approval.

**Comments:** \_\_\_\_\_

Reviewed by: Meghan Blodgett-Carrillo  
 Meghan Blodgett-Carrillo

## Hydrometer Report

<b>Project:</b> Q.C. - Lower Duwamish Waterway <b>Project #:</b> 21B233 <b>Client:</b> Anchor QEA <b>Source:</b> LDW21-GT23-GB-22.8-26.8 ft <b>Sample#:</b> B21-1963 <b>Date Received:</b> 29-Jul-21 <b>Sampled By:</b> Client <b>Date Tested:</b> 4-Oct-21 <b>Tested By:</b> K. Mendez	<b>Unified Soil Classification System, ASTM-2487</b> SM, Silty Sand <b>Sample Color</b> brown																																																																																																																																											
<b>ASTM D7928, HYDROMETER ANALYSIS</b>	<b>ASTM D6913</b>																																																																																																																																											
<table style="width: 100%;"> <tr> <td><b>Assumed Sp Gr :</b></td> <td style="text-align: right;">2.65</td> <td></td> </tr> <tr> <td><b>Sample Weight:</b></td> <td style="text-align: right;">76.06</td> <td>grams</td> </tr> <tr> <td><b>Hydroscopic Moist.:</b></td> <td style="text-align: right;">1.08%</td> <td></td> </tr> <tr> <td><b>Adj. Sample Wgt :</b></td> <td style="text-align: right;">75.25</td> <td>grams</td> </tr> </table> <table style="width: 100%;"> <thead> <tr> <th style="text-align: left;">Hydrometer Reading</th> <th style="text-align: left;">Corrected Reading</th> <th style="text-align: left;">Percent Passing</th> <th style="text-align: left;">Soils Particle Diameter</th> </tr> </thead> <tbody> <tr><td>1</td><td style="text-align: right;">7.5</td><td style="text-align: right;">10.0%</td><td style="text-align: right;">0.0532 mm</td></tr> <tr><td>2</td><td style="text-align: right;">6.5</td><td style="text-align: right;">8.6%</td><td style="text-align: right;">0.0378 mm</td></tr> <tr><td>5</td><td style="text-align: right;">5.5</td><td style="text-align: right;">7.3%</td><td style="text-align: right;">0.0240 mm</td></tr> <tr><td>15</td><td style="text-align: right;">4.5</td><td style="text-align: right;">6.0%</td><td style="text-align: right;">0.0139 mm</td></tr> <tr><td>30</td><td style="text-align: right;">3.5</td><td style="text-align: right;">4.6%</td><td style="text-align: right;">0.0099 mm</td></tr> <tr><td>60</td><td style="text-align: right;">2</td><td style="text-align: right;">2.7%</td><td style="text-align: right;">0.0070 mm</td></tr> <tr><td>240</td><td style="text-align: right;">1.5</td><td style="text-align: right;">2.0%</td><td style="text-align: right;">0.0035 mm</td></tr> <tr><td>1440</td><td style="text-align: right;">1</td><td style="text-align: right;">1.3%</td><td style="text-align: right;">0.0014 mm</td></tr> </tbody> </table> <table style="width: 100%;"> <tr> <td><b>% Gravel:</b></td> <td style="text-align: right;">0.0%</td> <td><b>Liquid Limit:</b></td> <td style="text-align: right;">n/a</td> </tr> <tr> <td><b>% Sand:</b></td> <td style="text-align: right;">78.3%</td> <td><b>Plastic Limit:</b></td> <td style="text-align: right;">n/a</td> </tr> <tr> <td><b>% Silt:</b></td> <td style="text-align: right;">19.5%</td> <td><b>Plasticity Index:</b></td> <td style="text-align: right;">n/a</td> </tr> <tr> <td><b>% Clay:</b></td> <td style="text-align: right;">2.3%</td> <td></td> <td></td> </tr> </table>	<b>Assumed Sp Gr :</b>	2.65		<b>Sample Weight:</b>	76.06	grams	<b>Hydroscopic Moist.:</b>	1.08%		<b>Adj. Sample Wgt :</b>	75.25	grams	Hydrometer Reading	Corrected Reading	Percent Passing	Soils Particle Diameter	1	7.5	10.0%	0.0532 mm	2	6.5	8.6%	0.0378 mm	5	5.5	7.3%	0.0240 mm	15	4.5	6.0%	0.0139 mm	30	3.5	4.6%	0.0099 mm	60	2	2.7%	0.0070 mm	240	1.5	2.0%	0.0035 mm	1440	1	1.3%	0.0014 mm	<b>% Gravel:</b>	0.0%	<b>Liquid Limit:</b>	n/a	<b>% Sand:</b>	78.3%	<b>Plastic Limit:</b>	n/a	<b>% Silt:</b>	19.5%	<b>Plasticity Index:</b>	n/a	<b>% Clay:</b>	2.3%			<table style="width: 100%;"> <tr> <th colspan="3" style="text-align: center;">Sieve Analysis</th> </tr> <tr> <th colspan="3" style="text-align: center;">Grain Size Distribution</th> </tr> <tr> <th style="text-align: left;">Sieve Size</th> <th style="text-align: left;">Percent Passing</th> <th style="text-align: left;">Soils Particle Diameter</th> </tr> <tr><td>3.0"</td><td style="text-align: right;">100%</td><td style="text-align: right;">75.000 mm</td></tr> <tr><td>2.0"</td><td style="text-align: right;">100%</td><td style="text-align: right;">50.000 mm</td></tr> <tr><td>1.5"</td><td style="text-align: right;">100%</td><td style="text-align: right;">37.500 mm</td></tr> <tr><td>1.25"</td><td style="text-align: right;">100%</td><td style="text-align: right;">31.500 mm</td></tr> <tr><td>1.0"</td><td style="text-align: right;">100%</td><td style="text-align: right;">25.000 mm</td></tr> <tr><td>3/4"</td><td style="text-align: right;">100%</td><td style="text-align: right;">19.000 mm</td></tr> <tr><td>5/8"</td><td style="text-align: right;">100%</td><td style="text-align: right;">16.000 mm</td></tr> <tr><td>1/2"</td><td style="text-align: right;">100%</td><td style="text-align: right;">12.500 mm</td></tr> <tr><td>3/8"</td><td style="text-align: right;">100%</td><td style="text-align: right;">9.500 mm</td></tr> <tr><td>1/4"</td><td style="text-align: right;">100%</td><td style="text-align: right;">6.300 mm</td></tr> <tr><td>#4</td><td style="text-align: right;">100%</td><td style="text-align: right;">4.750 mm</td></tr> <tr><td>#10</td><td style="text-align: right;">100%</td><td style="text-align: right;">2.000 mm</td></tr> <tr><td>#20</td><td style="text-align: right;">99%</td><td style="text-align: right;">0.850 mm</td></tr> <tr><td>#40</td><td style="text-align: right;">99%</td><td style="text-align: right;">0.425 mm</td></tr> <tr><td>#100</td><td style="text-align: right;">64%</td><td style="text-align: right;">0.150 mm</td></tr> <tr><td>#200</td><td style="text-align: right;">21.7%</td><td style="text-align: right;">0.075 mm</td></tr> <tr><td><b>Silts</b></td><td style="text-align: right;">21.2%</td><td style="text-align: right;">0.074 mm</td></tr> <tr><td></td><td style="text-align: right;">9.8%</td><td style="text-align: right;">0.050 mm</td></tr> <tr><td></td><td style="text-align: right;">6.8%</td><td style="text-align: right;">0.020 mm</td></tr> <tr><td><b>Clays</b></td><td style="text-align: right;">2.3%</td><td style="text-align: right;">0.005 mm</td></tr> <tr><td></td><td style="text-align: right;">1.5%</td><td style="text-align: right;">0.002 mm</td></tr> <tr><td><b>Colloids</b></td><td style="text-align: right;">0.9%</td><td style="text-align: right;">0.001 mm</td></tr> </table>	Sieve Analysis			Grain Size Distribution			Sieve Size	Percent Passing	Soils Particle Diameter	3.0"	100%	75.000 mm	2.0"	100%	50.000 mm	1.5"	100%	37.500 mm	1.25"	100%	31.500 mm	1.0"	100%	25.000 mm	3/4"	100%	19.000 mm	5/8"	100%	16.000 mm	1/2"	100%	12.500 mm	3/8"	100%	9.500 mm	1/4"	100%	6.300 mm	#4	100%	4.750 mm	#10	100%	2.000 mm	#20	99%	0.850 mm	#40	99%	0.425 mm	#100	64%	0.150 mm	#200	21.7%	0.075 mm	<b>Silts</b>	21.2%	0.074 mm		9.8%	0.050 mm		6.8%	0.020 mm	<b>Clays</b>	2.3%	0.005 mm		1.5%	0.002 mm	<b>Colloids</b>	0.9%	0.001 mm
<b>Assumed Sp Gr :</b>	2.65																																																																																																																																											
<b>Sample Weight:</b>	76.06	grams																																																																																																																																										
<b>Hydroscopic Moist.:</b>	1.08%																																																																																																																																											
<b>Adj. Sample Wgt :</b>	75.25	grams																																																																																																																																										
Hydrometer Reading	Corrected Reading	Percent Passing	Soils Particle Diameter																																																																																																																																									
1	7.5	10.0%	0.0532 mm																																																																																																																																									
2	6.5	8.6%	0.0378 mm																																																																																																																																									
5	5.5	7.3%	0.0240 mm																																																																																																																																									
15	4.5	6.0%	0.0139 mm																																																																																																																																									
30	3.5	4.6%	0.0099 mm																																																																																																																																									
60	2	2.7%	0.0070 mm																																																																																																																																									
240	1.5	2.0%	0.0035 mm																																																																																																																																									
1440	1	1.3%	0.0014 mm																																																																																																																																									
<b>% Gravel:</b>	0.0%	<b>Liquid Limit:</b>	n/a																																																																																																																																									
<b>% Sand:</b>	78.3%	<b>Plastic Limit:</b>	n/a																																																																																																																																									
<b>% Silt:</b>	19.5%	<b>Plasticity Index:</b>	n/a																																																																																																																																									
<b>% Clay:</b>	2.3%																																																																																																																																											
Sieve Analysis																																																																																																																																												
Grain Size Distribution																																																																																																																																												
Sieve Size	Percent Passing	Soils Particle Diameter																																																																																																																																										
3.0"	100%	75.000 mm																																																																																																																																										
2.0"	100%	50.000 mm																																																																																																																																										
1.5"	100%	37.500 mm																																																																																																																																										
1.25"	100%	31.500 mm																																																																																																																																										
1.0"	100%	25.000 mm																																																																																																																																										
3/4"	100%	19.000 mm																																																																																																																																										
5/8"	100%	16.000 mm																																																																																																																																										
1/2"	100%	12.500 mm																																																																																																																																										
3/8"	100%	9.500 mm																																																																																																																																										
1/4"	100%	6.300 mm																																																																																																																																										
#4	100%	4.750 mm																																																																																																																																										
#10	100%	2.000 mm																																																																																																																																										
#20	99%	0.850 mm																																																																																																																																										
#40	99%	0.425 mm																																																																																																																																										
#100	64%	0.150 mm																																																																																																																																										
#200	21.7%	0.075 mm																																																																																																																																										
<b>Silts</b>	21.2%	0.074 mm																																																																																																																																										
	9.8%	0.050 mm																																																																																																																																										
	6.8%	0.020 mm																																																																																																																																										
<b>Clays</b>	2.3%	0.005 mm																																																																																																																																										
	1.5%	0.002 mm																																																																																																																																										
<b>Colloids</b>	0.9%	0.001 mm																																																																																																																																										
<b>USDA Soil Textural Classification</b>																																																																																																																																												
<table style="width: 100%;"> <tr> <td></td> <td style="text-align: left;"><b>Particle Size</b></td> </tr> <tr> <td><b>% Sand:</b></td> <td style="text-align: left;">2.0 - 0.05 mm</td> </tr> <tr> <td><b>% Silt:</b></td> <td style="text-align: left;">0.05 - 0.002 mm</td> </tr> <tr> <td><b>% Clay:</b></td> <td style="text-align: left;">&lt; 0.002 mm</td> </tr> </table> <p style="text-align: center;"><b>USDA Soil Textural Classification</b> Sand</p>		<b>Particle Size</b>	<b>% Sand:</b>	2.0 - 0.05 mm	<b>% Silt:</b>	0.05 - 0.002 mm	<b>% Clay:</b>	< 0.002 mm																																																																																																																																				
	<b>Particle Size</b>																																																																																																																																											
<b>% Sand:</b>	2.0 - 0.05 mm																																																																																																																																											
<b>% Silt:</b>	0.05 - 0.002 mm																																																																																																																																											
<b>% Clay:</b>	< 0.002 mm																																																																																																																																											

All results apply only to actual locations and materials tested. As a mutual protection to clients, the public and ourselves, all reports are submitted as the confidential property of clients, and authorization for publication of statements, conclusions or extracts from or regarding our reports is reserved pending our written approval.

**Comments:** \_\_\_\_\_

\_\_\_\_\_

\_\_\_\_\_

**Reviewed by:** \_\_\_\_\_  
 Meghan Blodgett-Carrillo



**Client:** Anchor QEA  
**Address:** 21328 2nd Drive SE  
Bothell, WA 98021  
**Attn:** Garrett Timm  
**Revised on:** \_\_\_\_\_

**Date:** October 19, 2021  
**Project:** Q.C. - Lower Duwamish Waterway  
**Project #:** 21B233  
**Sample #:** B21-2050-2069  
**Date sampled:** 8-4-21 & 8-5-21

As requested MTC, Inc. has performed the following test(s) on the sample referenced above. The testing was performed in accordance with current applicable AASHTO or ASTM standards as indicated below. The results obtained in our laboratory were as follows below or on the attached pages:

	Test(s) Performed:	Test Results		Test(s) Performed:	Test Results
X	Sieve Analysis	Please See Attached Reports		Sulfate Soundness	
	Proctor			Bulk Density & Voids	
	Sand Equivalent			WSDOT Degradation	
	Fracture Count			LA Abrasion	
X	Moisture Content	Please See Attached Report	X	Direct Shear	Please See Attached Reports
	Specific Gravity, Coarse		X	Specific Gravity, Soils	Please See Attached Reports
	Specific Gravity, Fine				
X	Hydrometer Analysis	Please See Attached Reports			
X	Atterberg Limits	Please See Attached Reports			

If you have any questions concerning the test results, the procedures used, or if we can be of any further assistance please call on us at the number below.

Respectfully Submitted,  
 Meghan Blodgett-Carrillo  
 WABO Supervising Laboratory Technician



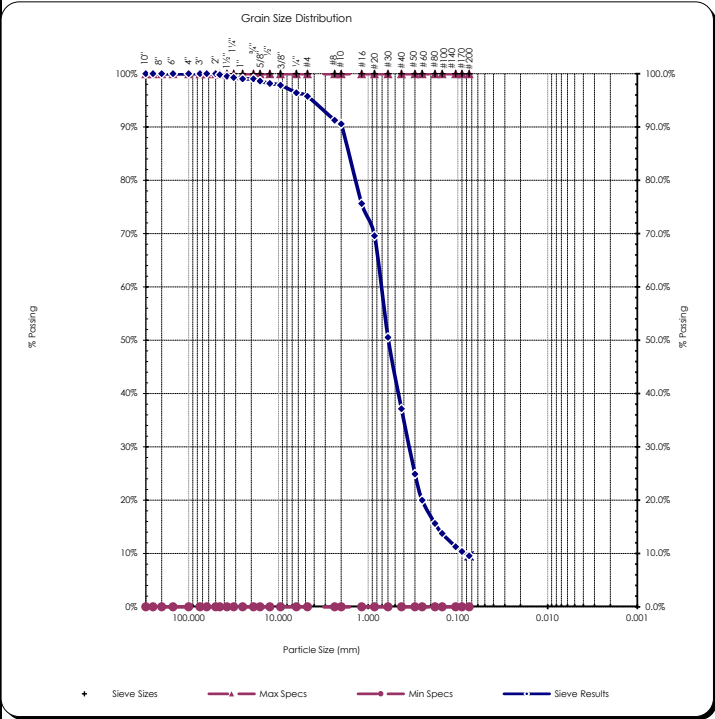


# Sieve Report

<b>Project:</b> Q.C. - Lower Duwamish Waterway <b>Project #:</b> 21B233 <b>Client:</b> Anchor QEA <b>Source:</b> LDW21-GT44-GB-0-5 ft <b>Sample#:</b> B21-2050	<b>Date Received:</b> 29-Jul-21 <b>Sampled By:</b> Client <b>Date Tested:</b> 8-Oct-21 <b>Tested By:</b> A. Eifrig	<b>Unified Soil Classification System, ASTM-2487</b> SW-SC, Well-graded Sand with Silty Clay <b>Sample Color:</b> brown	 <b>ACCREDITED</b> Certificate #: 1366.01
--	---	--	---

<b>ASTM D2216, ASTM D2419, ASTM D4318, ASTM D5281</b>			
<b>Specifications</b> No Specs <b>Sample Meets Specs ?</b> N/A	D <sub>(5)</sub> = 0.039 mm D <sub>(10)</sub> = 0.083 mm D <sub>(15)</sub> = 0.170 mm D <sub>(30)</sub> = 0.352 mm D <sub>(50)</sub> = 0.593 mm D <sub>(60)</sub> = 0.724 mm D <sub>(90)</sub> = 1.967 mm Dust Ratio = 9/35	% Gravel = 4.2% % Sand = 86.2% % Silt & Clay = 9.6% Liquid Limit = n/a Plasticity Index = n/a Sand Equivalent = n/a Fracture %, 1 Face = n/a Fracture %, 2+ Faces = n/a	Coeff. of Curvature, C <sub>c</sub> = 2.07 Coeff. of Uniformity, C <sub>u</sub> = 8.74 Fineness Modulus = 2.51 Plastic Limit = n/a Moisture %, as sampled = 27.9% Req'd Sand Equivalent = Req'd Fracture %, 1 Face = Req'd Fracture %, 2+ Faces =

<b>ASTM C136, ASTM D6913, ASTM C117</b>					
Sieve Size		Actual Cumulative Percent Passing	Interpolated Cumulative Percent Passing	Specs Max	Specs Min
US	Metric				
12.00"	300.00		100%	100.0%	0.0%
10.00"	250.00		100%	100.0%	0.0%
8.00"	200.00		100%	100.0%	0.0%
6.00"	150.00		100%	100.0%	0.0%
4.00"	100.00		100%	100.0%	0.0%
3.00"	75.00		100%	100.0%	0.0%
2.50"	63.00		100%	100.0%	0.0%
2.00"	50.00	100%	100%	100.0%	0.0%
1.75"	45.00		100%	100.0%	0.0%
1.50"	37.50		100%	100.0%	0.0%
1.25"	31.50		99%	100.0%	0.0%
1.00"	25.00	99%	99%	100.0%	0.0%
3/4"	19.00	99%	99%	100.0%	0.0%
5/8"	16.00		99%	100.0%	0.0%
1/2"	12.50	98%	98%	100.0%	0.0%
3/8"	9.50	98%	98%	100.0%	0.0%
1/4"	6.30		96%	100.0%	0.0%
#4	4.75	96%	96%	100.0%	0.0%
#8	2.36		91%	100.0%	0.0%
#10	2.00	91%	91%	100.0%	0.0%
#16	1.18		76%	100.0%	0.0%
#20	0.850	70%	70%	100.0%	0.0%
#30	0.600		51%	100.0%	0.0%
#40	0.425	37%	37%	100.0%	0.0%
#50	0.300		25%	100.0%	0.0%
#60	0.250	20%	20%	100.0%	0.0%
#80	0.180		16%	100.0%	0.0%
#100	0.150	14%	14%	100.0%	0.0%
#140	0.106		11%	100.0%	0.0%
#170	0.090		10%	100.0%	0.0%
#200	0.075	9.6%	9.6%	100.0%	0.0%



Copyright Spears Engineering & Technical Services PS, 1996-98  
 All results apply only to actual locations and materials tested. As a mutual protection to clients, the public and ourselves, all reports are submitted as the confidential property of clients, and authorization for publication of statements, conclusions or extracts from or regarding our reports is reserved pending our written approval.

**Comments:** \_\_\_\_\_

Reviewed by:   
 Meghan Blodgett-Carrillo



# Direct Shear Test Results:

ASTM D-3080



Project: Q.C. - Lower Duwamish Waterway  
 Project Number: 21B233  
 Laboratory Sample ID: B21-2050  
 Sample Date: 8/4/2021  
 Test Date: 10/13/2021  
 Technician: M. Carrillo

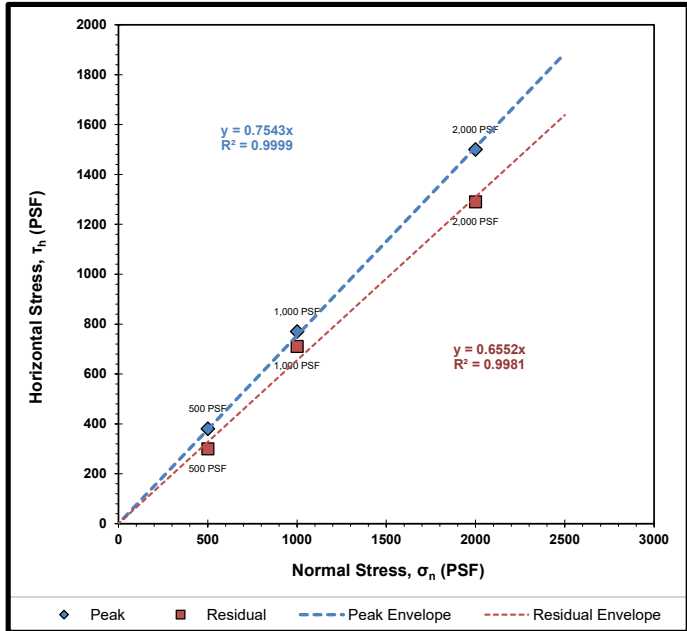
Sample Source: LDW21-GT44-GB-0-5 ft  
 Visual Soil Description: brown silty sand with gravel  
 Type of Specimen: Remolded Cylindrical Shear Box  
 Specimen Diameter (in): 2.5  
 Specimen Height (in): 1  
 Rate of Strain (in/min): 0.0208  
 Estimated Specific Gravity of Solids: 2.65

Summary of Sample Data: $\sigma_n=500$ PSF		
Initial Moisture Content (%)	24.6	
	Initial	Post-Consolidation
Dry Density (PCF):	109.7	110.8
Void Ratio:	0.536	0.520
Porosity (%):	34.9	34.2
Degree of Saturation (%):	saturated	saturated

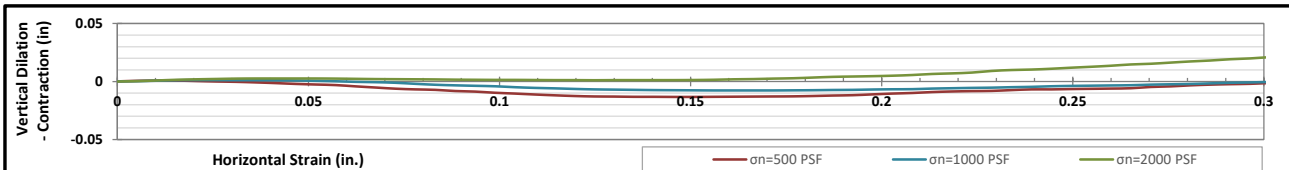
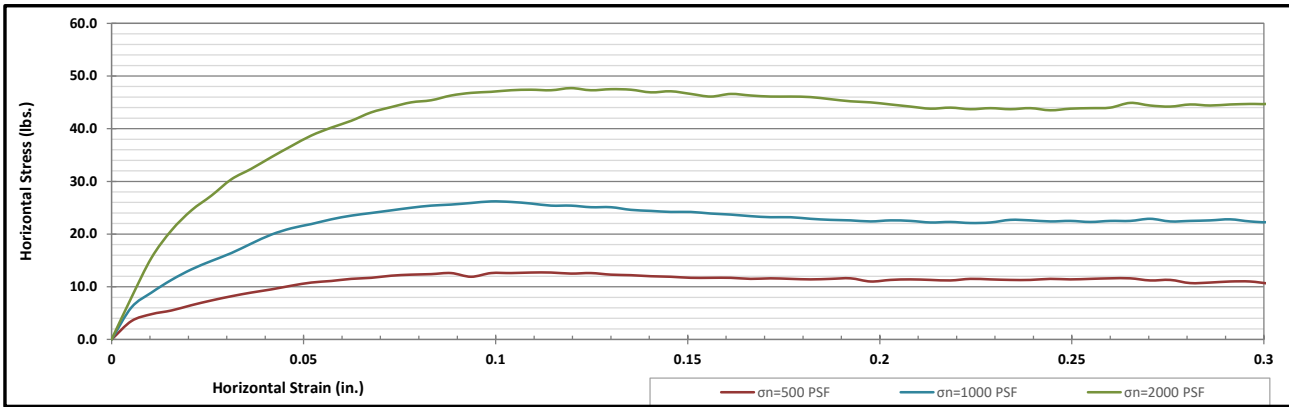
Summary of Sample Data: $\sigma_n=1000$ PSF		
Initial Moisture Content (%)	23.8	
	Initial	Post-Consolidation
Dry Density (PCF):	110.7	113.4
Void Ratio:	0.523	0.486
Porosity (%):	34.3	32.7
Degree of Saturation (%):	saturated	saturated

Summary of Sample Data: $\sigma_n=2000$ PSF		
Initial Moisture Content (%)	23.8	
	Initial	Post-Consolidation
Dry Density (PCF):	110.9	114.3
Void Ratio:	0.520	0.473
Porosity (%):	34.2	32.1
Degree of Saturation (%):	saturated	saturated

ESTIMATED STRENGTH PARAMETERS		
	PEAK	RESIDUAL
Angle of Internal Friction, $\phi$ (°):	37	33
Cohesion (PSF):	0	0



Failure Envelope Test Values:			
Normal Stress, $\sigma_n$ (PSF):	500	1000	2000
Peak Horizontal Stress, $\tau_h$ (PSF):	380	770	1500
Residual Horizontal Stress, $\tau_r$ (PSF):	300	710	1290



Corporate • 777 Chrysler Drive • Burlington, WA 98233 • Phone 360.755.1990 • Fax 360.755.1980  
 SW Region • 2118 Black Lake Blvd. S.W. • Olympia, WA 98512 • Phone 360.534.9777 • Fax 360.534.9779  
 NW Region • 805 Dupont, Suite #5 • Bellingham, WA 98225 • Phone 360.647.6061 • Fax 360.647.8111  
 Kitsap Region • 5451 N.W. Newberry Hill Road, Suite 101 • Silverdale, WA 98383 • Phone/Fax 360.698.6787

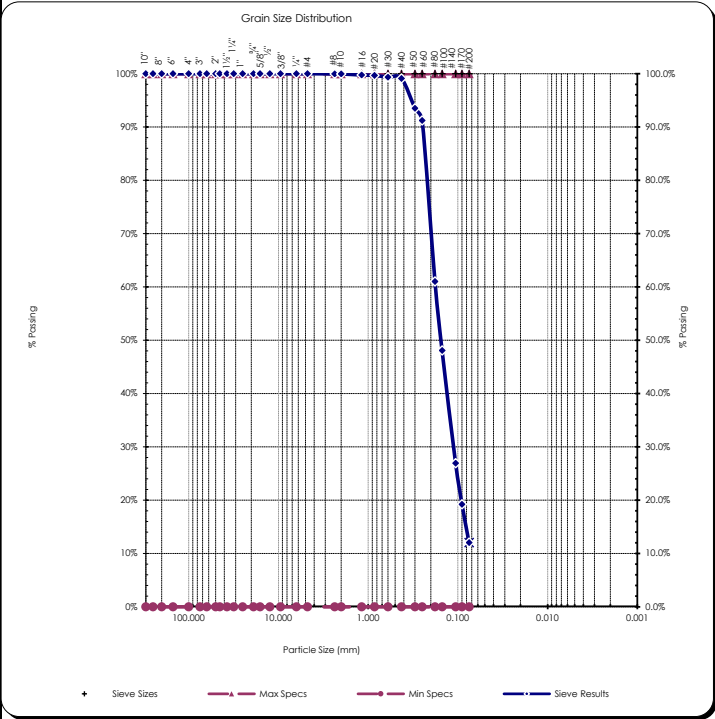
Visit our website: [www.mtc-inc.net](http://www.mtc-inc.net)

# Sieve Report

<b>Project:</b> Q.C. - Lower Duwamish Waterway <b>Project #:</b> 21B233 <b>Client:</b> Anchor QEA <b>Source:</b> LDW21-GT44-GB-5-10 ft <b>Sample#:</b> B21-2053	<b>Date Received:</b> 29-Jul-21 <b>Sampled By:</b> Client <b>Date Tested:</b> 8-Oct-21 <b>Tested By:</b> A. Eifrig	<b>Unified Soil Classification System, ASTM-2487</b> SM, Silty Sand <b>Sample Color:</b> dark brown	 <b>ACCREDITED</b> Certificate #: 1366.01
---	---	--	---

<b>ASTM D2216, ASTM D2419, ASTM D4318, ASTM D5281</b>			
<b>Specifications</b> No Specs <b>Sample Meets Specs ?</b> N/A	D <sub>(5)</sub> = 0.031 mm D <sub>(10)</sub> = 0.062 mm D <sub>(15)</sub> = 0.081 mm D <sub>(30)</sub> = 0.112 mm D <sub>(50)</sub> = 0.154 mm D <sub>(60)</sub> = 0.178 mm D <sub>(90)</sub> = 0.247 mm Dust Ratio = 9/74	% Gravel = 0.0% % Sand = 88.0% % Silt & Clay = 12.0% Liquid Limit = n/a Plasticity Index = n/a Sand Equivalent = n/a Fracture %, 1 Face = n/a Fracture %, 2+ Faces = n/a	Coeff. of Curvature, C <sub>c</sub> = 1.14 Coeff. of Uniformity, C <sub>u</sub> = 2.85 Fineness Modulus = 0.59 Plastic Limit = n/a Moisture %, as sampled = 32.0% Req'd Sand Equivalent = Req'd Fracture %, 1 Face = Req'd Fracture %, 2+ Faces =

<b>ASTM C136, ASTM D6913, ASTM C117</b>					
Sieve Size		Actual Cumulative Percent Passing	Interpolated Cumulative Percent Passing	Specs Max	Specs Min
US	Metric				
12.00"	300.00		100%	100.0%	0.0%
10.00"	250.00		100%	100.0%	0.0%
8.00"	200.00		100%	100.0%	0.0%
6.00"	150.00		100%	100.0%	0.0%
4.00"	100.00		100%	100.0%	0.0%
3.00"	75.00		100%	100.0%	0.0%
2.50"	63.00		100%	100.0%	0.0%
2.00"	50.00	100%	100%	100.0%	0.0%
1.75"	45.00	100%	100%	100.0%	0.0%
1.50"	37.50	100%	100%	100.0%	0.0%
1.25"	31.50	100%	100%	100.0%	0.0%
1.00"	25.00	100%	100%	100.0%	0.0%
3/4"	19.00	100%	100%	100.0%	0.0%
5/8"	16.00	100%	100%	100.0%	0.0%
1/2"	12.50	100%	100%	100.0%	0.0%
3/8"	9.50	100%	100%	100.0%	0.0%
1/4"	6.30	100%	100%	100.0%	0.0%
#4	4.75	100%	100%	100.0%	0.0%
#8	2.36	100%	100%	100.0%	0.0%
#10	2.00	100%	100%	100.0%	0.0%
#16	1.18	100%	100%	100.0%	0.0%
#20	0.850	100%	100%	100.0%	0.0%
#30	0.600	99%	99%	100.0%	0.0%
#40	0.425	99%	99%	100.0%	0.0%
#50	0.300	93%	93%	100.0%	0.0%
#60	0.250	91%	91%	100.0%	0.0%
#80	0.180	61%	61%	100.0%	0.0%
#100	0.150	48%	48%	100.0%	0.0%
#140	0.106	27%	27%	100.0%	0.0%
#170	0.090	19%	19%	100.0%	0.0%
#200	0.075	12.0%	12.0%	100.0%	0.0%



Copyright Spears Engineering & Technical Services PS, 1996-98  
 All results apply only to actual locations and materials tested. As a mutual protection to clients, the public and ourselves, all reports are submitted as the confidential property of clients, and authorization for publication of statements, conclusions or extracts from or regarding our reports is reserved pending our written approval.

**Comments:** \_\_\_\_\_

Reviewed by:   
 Meghan Blodgett-Carrillo

# Sieve Report

<b>Project:</b> Q.C. - Lower Duwamish Waterway <b>Project #:</b> 21B233 <b>Client:</b> Anchor QEA <b>Source:</b> LDW21-GT44-GB-10-15 ft <b>Sample#:</b> B21-2055	<b>Date Received:</b> 29-Jul-21 <b>Sampled By:</b> Client <b>Date Tested:</b> 8-Oct-21 <b>Tested By:</b> A. Eifrig	<b>Unified Soil Classification System, ASTM-2487</b> SP-SM, Poorly graded Sand with Silt <b>Sample Color:</b> dark brown	 <b>ACCREDITED</b> Certificate #: 1366.01
--	---	---	---

**ASTM D2216, ASTM D2419, ASTM D4318, ASTM D5281**

**Specifications**

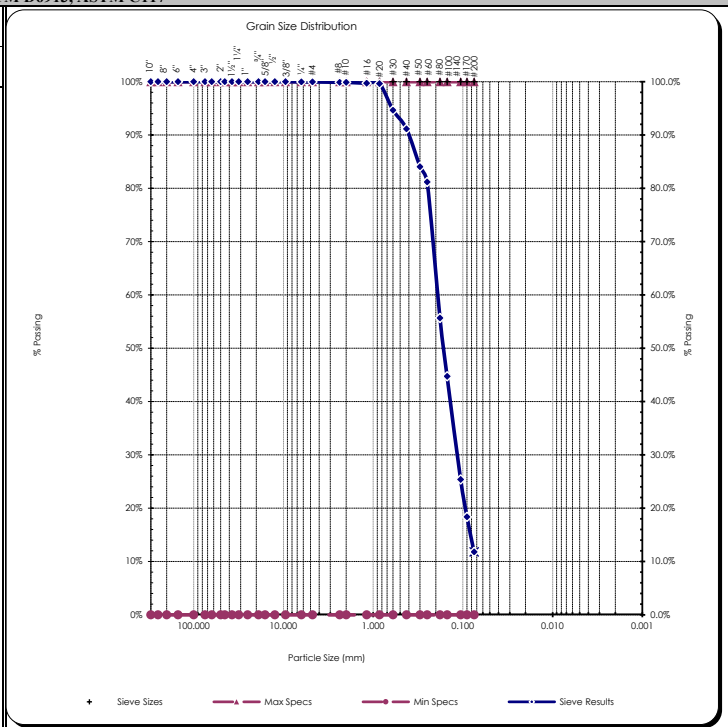
No Specs

Sample Meets Specs ? **N/A**

D <sub>(5)</sub> = 0.032 mm	% Gravel = 0.0%	Coeff. of Curvature, C <sub>c</sub> = 1.11
D <sub>(10)</sub> = 0.064 mm	% Sand = 88.2%	Coeff. of Uniformity, C <sub>u</sub> = 3.02
D <sub>(15)</sub> = 0.082 mm	% Silt & Clay = 11.8%	Fineness Modulus = 0.77
D <sub>(30)</sub> = 0.116 mm	Liquid Limit = n/a	Plastic Limit = n/a
D <sub>(50)</sub> = 0.164 mm	Plasticity Index = n/a	Moisture %, as sampled = 29.7%
D <sub>(60)</sub> = 0.192 mm	Sand Equivalent = n/a	Req'd Sand Equivalent =
D <sub>(90)</sub> = 0.404 mm	Fracture %, 1 Face = n/a	Req'd Fracture %, 1 Face =
Dust Ratio = 11/85	Fracture %, 2+ Faces = n/a	Req'd Fracture %, 2+ Faces =

**ASTM C136, ASTM D6913, ASTM C117**

Sieve Size		Actual Cumulative Percent Passing	Interpolated Cumulative Percent Passing	Specs Max	Specs Min
US	Metric				
12.00"	300.00		100%	100.0%	0.0%
10.00"	250.00		100%	100.0%	0.0%
8.00"	200.00		100%	100.0%	0.0%
6.00"	150.00		100%	100.0%	0.0%
4.00"	100.00		100%	100.0%	0.0%
3.00"	75.00		100%	100.0%	0.0%
2.50"	63.00		100%	100.0%	0.0%
2.00"	50.00	100%	100%	100.0%	0.0%
1.75"	45.00	100%	100%	100.0%	0.0%
1.50"	37.50	100%	100%	100.0%	0.0%
1.25"	31.50	100%	100%	100.0%	0.0%
1.00"	25.00	100%	100%	100.0%	0.0%
3/4"	19.00	100%	100%	100.0%	0.0%
5/8"	16.00	100%	100%	100.0%	0.0%
1/2"	12.50	100%	100%	100.0%	0.0%
3/8"	9.50	100%	100%	100.0%	0.0%
1/4"	6.30	100%	100%	100.0%	0.0%
#4	4.75	100%	100%	100.0%	0.0%
#8	2.36	100%	100%	100.0%	0.0%
#10	2.00	100%	100%	100.0%	0.0%
#16	1.18	100%	100%	100.0%	0.0%
#20	0.850	100%	100%	100.0%	0.0%
#30	0.600	95%	95%	100.0%	0.0%
#40	0.425	91%	91%	100.0%	0.0%
#50	0.300	84%	84%	100.0%	0.0%
#60	0.250	81%	81%	100.0%	0.0%
#80	0.180	56%	56%	100.0%	0.0%
#100	0.150	45%	45%	100.0%	0.0%
#140	0.106	25%	25%	100.0%	0.0%
#170	0.090	18%	18%	100.0%	0.0%
#200	0.075	11.8%	11.8%	100.0%	0.0%



Copyright Spears Engineering & Technical Services PS, 1996-98

All results apply only to actual locations and materials tested. As a mutual protection to clients, the public and ourselves, all reports are submitted as the confidential property of clients, and authorization for publication of statements, conclusions or extracts from or regarding our reports is reserved pending our written approval.

**Comments:**

Reviewed by:   
 Meghan Blodgett-Carrillo



# Sieve Report

<b>Project:</b> Q.C. - Lower Duwamish Waterway <b>Project #:</b> 21B233 <b>Client:</b> Anchor QEA <b>Source:</b> LDW21-GT44-GB-15-20 ft <b>Sample#:</b> B21-2057	<b>Date Received:</b> 29-Jul-21 <b>Sampled By:</b> Client <b>Date Tested:</b> 8-Oct-21 <b>Tested By:</b> A. Eifrig	<b>Visual Identification</b> Sandy Silt <b>Sample Color:</b> dark brown	 Certificate #: 1366.01
--	---	--	----------------------------

**ASTM D2216, ASTM D2419, ASTM D4318, ASTM D5281**

**Specifications**

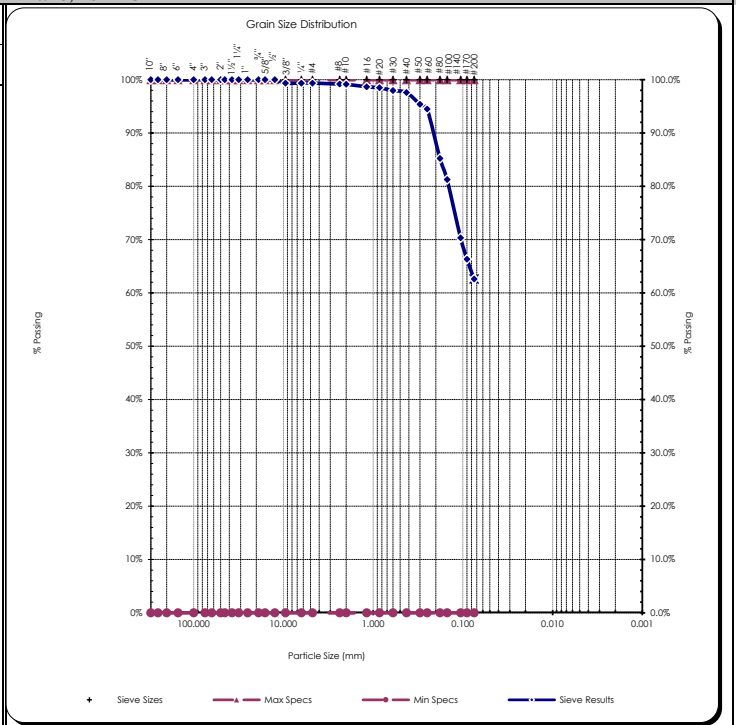
No Specs

Sample Meets Specs ? **N/A**

D <sub>(5)</sub> = 0.006 mm	% Gravel = 0.6%	Coeff. of Curvature, C <sub>c</sub> = 1.50
D <sub>(10)</sub> = 0.012 mm	% Sand = 36.7%	Coeff. of Uniformity, C <sub>u</sub> = 6.00
D <sub>(15)</sub> = 0.018 mm	% Silt & Clay = 62.6%	Fineness Modulus = 0.29
D <sub>(30)</sub> = 0.036 mm	Liquid Limit = n/a	Plastic Limit = n/a
D <sub>(50)</sub> = 0.060 mm	Plasticity Index = n/a	Moisture %, as sampled = 36.8%
D <sub>(60)</sub> = 0.072 mm	Sand Equivalent = n/a	Req'd Sand Equivalent =
D <sub>(90)</sub> = 0.216 mm	Fracture %, 1 Face = n/a	Req'd Fracture %, 1 Face =
Dust Ratio = 43/67	Fracture %, 2+ Faces = n/a	Req'd Fracture %, 2+ Faces =

**ASTM C136, ASTM D6913, ASTM C117**

Sieve Size		Actual Cumulative Percent Passing	Interpolated Cumulative Percent Passing	Specs Max	Specs Min
US	Metric				
12.00"	300.00		100%	100.0%	0.0%
10.00"	250.00		100%	100.0%	0.0%
8.00"	200.00		100%	100.0%	0.0%
6.00"	150.00		100%	100.0%	0.0%
4.00"	100.00		100%	100.0%	0.0%
3.00"	75.00		100%	100.0%	0.0%
2.50"	63.00		100%	100.0%	0.0%
2.00"	50.00	100%	100%	100.0%	0.0%
1.75"	45.00		100%	100.0%	0.0%
1.50"	37.50		100%	100.0%	0.0%
1.25"	31.50		100%	100.0%	0.0%
1.00"	25.00	100%	100%	100.0%	0.0%
3/4"	19.00	100%	100%	100.0%	0.0%
5/8"	16.00		100%	100.0%	0.0%
1/2"	12.50	100%	100%	100.0%	0.0%
3/8"	9.50	99%	99%	100.0%	0.0%
1/4"	6.30		99%	100.0%	0.0%
#4	4.75	99%	99%	100.0%	0.0%
#8	2.36		99%	100.0%	0.0%
#10	2.00	99%	99%	100.0%	0.0%
#16	1.18		99%	100.0%	0.0%
#20	0.850	98%	98%	100.0%	0.0%
#30	0.600		98%	100.0%	0.0%
#40	0.425	98%	98%	100.0%	0.0%
#50	0.300		95%	100.0%	0.0%
#60	0.250	94%	94%	100.0%	0.0%
#80	0.180		85%	100.0%	0.0%
#100	0.150	81%	81%	100.0%	0.0%
#140	0.106		70%	100.0%	0.0%
#170	0.090		66%	100.0%	0.0%
#200	0.075	62.6%	62.6%	100.0%	0.0%



Copyright Spears Engineering & Technical Services PS, 1996-98

All results apply only to actual locations and materials tested. As a mutual protection to clients, the public and ourselves, all reports are submitted as the confidential property of clients, and authorization for publication of statements, conclusions or extracts from or regarding our reports is reserved pending our written approval.

**Comments:**

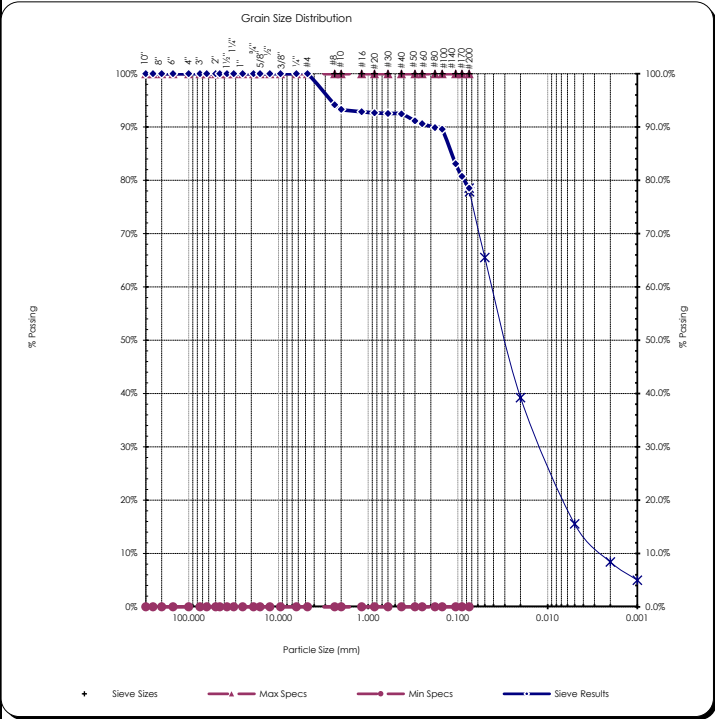
Reviewed by:   
 Meghan Blodgett-Carrillo

# Sieve Report

<b>Project:</b> Q.C. - Lower Duwamish Waterway <b>Project #:</b> 21B233 <b>Client:</b> Anchor QEA <b>Source:</b> LDW21-GT44-GB-20-25 ft <b>Sample#:</b> B21-2059	<b>Date Received:</b> 29-Jul-21 <b>Sampled By:</b> Client <b>Date Tested:</b> 8-Oct-21 <b>Tested By:</b> A. Eifrig	<b>Visual Identification</b> Sandy Silt with Clay <b>Sample Color:</b> brown	 <b>ACCREDITED</b> Certificate #: 1366.01
--	---	---	---

<b>ASTM D2216, ASTM D2419, ASTM D4318, ASTM D5281</b>			
<b>Specifications</b> No Specs <b>Sample Meets Specs ?</b> N/A	D <sub>(5)</sub> = 0.001 mm D <sub>(10)</sub> = 0.003 mm D <sub>(15)</sub> = 0.005 mm D <sub>(30)</sub> = 0.014 mm D <sub>(50)</sub> = 0.032 mm D <sub>(60)</sub> = 0.048 mm D <sub>(90)</sub> = 0.190 mm Dust Ratio = 17/20	% Gravel = 0.0% % Sand = 21.5% % Silt & Clay = 78.5% Liquid Limit = n/a Plasticity Index = n/a Sand Equivalent = n/a Fracture %, 1 Face = n/a Fracture %, 2+ Faces = n/a	Coeff. of Curvature, C <sub>c</sub> = 1.61 Coeff. of Uniformity, C <sub>u</sub> = 17.87 Fineness Modulus = 0.40 Plastic Limit = n/a Moisture %, as sampled = 37.4% Req'd Sand Equivalent = Req'd Fracture %, 1 Face = Req'd Fracture %, 2+ Faces =

<b>ASTM C136, ASTM D6913, ASTM C117</b>					
Sieve Size		Actual Cumulative Percent Passing	Interpolated Cumulative Percent Passing	Specs Max	Specs Min
US	Metric				
12.00"	300.00		100%	100.0%	0.0%
10.00"	250.00		100%	100.0%	0.0%
8.00"	200.00		100%	100.0%	0.0%
6.00"	150.00		100%	100.0%	0.0%
4.00"	100.00		100%	100.0%	0.0%
3.00"	75.00		100%	100.0%	0.0%
2.50"	63.00		100%	100.0%	0.0%
2.00"	50.00	100%	100%	100.0%	0.0%
1.75"	45.00	100%	100%	100.0%	0.0%
1.50"	37.50	100%	100%	100.0%	0.0%
1.25"	31.50	100%	100%	100.0%	0.0%
1.00"	25.00	100%	100%	100.0%	0.0%
3/4"	19.00	100%	100%	100.0%	0.0%
5/8"	16.00	100%	100%	100.0%	0.0%
1/2"	12.50	100%	100%	100.0%	0.0%
3/8"	9.50	100%	100%	100.0%	0.0%
1/4"	6.30	100%	100%	100.0%	0.0%
#4	4.75	100%	100%	100.0%	0.0%
#8	2.36		94%	100.0%	0.0%
#10	2.00	93%	93%	100.0%	0.0%
#16	1.18		93%	100.0%	0.0%
#20	0.850		93%	100.0%	0.0%
#30	0.600		93%	100.0%	0.0%
#40	0.425	92%	92%	100.0%	0.0%
#50	0.300		91%	100.0%	0.0%
#60	0.250		91%	100.0%	0.0%
#80	0.180		90%	100.0%	0.0%
#100	0.150	90%	90%	100.0%	0.0%
#140	0.106		83%	100.0%	0.0%
#170	0.090		81%	100.0%	0.0%
#200	0.075	78.5%	78.5%	100.0%	0.0%



Copyright Spears Engineering & Technical Services PS, 1996-98  
 All results apply only to actual locations and materials tested. As a mutual protection to clients, the public and ourselves, all reports are submitted as the confidential property of clients, and authorization for publication of statements, conclusions or extracts from or regarding our reports is reserved pending our written approval.

**Comments:** \_\_\_\_\_

Reviewed by:   
 Meghan Blodgett-Carrillo

## Hydrometer Report

<p><b>Project:</b> Q.C. - Lower Duwamish Waterway    <b>Date Received:</b> 29-Jul-21  <b>Project #:</b> 21B233    <b>Sampled By:</b> Client  <b>Client:</b> Anchor QEA    <b>Date Tested:</b> 8-Oct-21  <b>Source:</b> LDW21-GT44-GB-20-25 ft    <b>Tested By:</b> A. Eifrig  <b>Sample#:</b> B21-2059</p>	<p><b>Visual Identification</b> Sandy Silt with Clay <b>Sample Color</b> brown</p>																																																																																																																																																			
<b>ASTM D7928, HYDROMETER ANALYSIS</b>	<b>ASTM D6913</b>																																																																																																																																																			
<table style="width: 100%;"> <tr> <td><b>Assumed Sp Gr :</b></td> <td style="text-align: right;">2.65</td> <td></td> </tr> <tr> <td><b>Sample Weight:</b></td> <td style="text-align: right;">75.15</td> <td>grams</td> </tr> <tr> <td><b>Hydroscopic Moist.:</b></td> <td style="text-align: right;">3.83%</td> <td></td> </tr> <tr> <td><b>Adj. Sample Wgt :</b></td> <td style="text-align: right;">72.38</td> <td>grams</td> </tr> </table> <table style="width: 100%;"> <tr> <td style="text-align: center;"><b>Hydrometer</b></td> <td></td> <td></td> <td></td> </tr> <tr> <td style="text-align: center;"><b>Reading</b></td> <td style="text-align: center;"><b>Corrected</b></td> <td style="text-align: center;"><b>Percent</b></td> <td style="text-align: center;"><b>Soils Particle</b></td> </tr> <tr> <td style="text-align: center;"><b>Minutes</b></td> <td style="text-align: center;"><b>Reading</b></td> <td style="text-align: center;"><b>Passing</b></td> <td style="text-align: center;"><b>Diameter</b></td> </tr> <tr> <td style="text-align: center;">1</td> <td style="text-align: center;">43</td> <td style="text-align: center;">55.4%</td> <td style="text-align: center;">0.0414 mm</td> </tr> <tr> <td style="text-align: center;">2</td> <td style="text-align: center;">38</td> <td style="text-align: center;">49.0%</td> <td style="text-align: center;">0.0307 mm</td> </tr> <tr> <td style="text-align: center;">5</td> <td style="text-align: center;">31</td> <td style="text-align: center;">40.0%</td> <td style="text-align: center;">0.0204 mm</td> </tr> <tr> <td style="text-align: center;">15</td> <td style="text-align: center;">21</td> <td style="text-align: center;">27.1%</td> <td style="text-align: center;">0.0127 mm</td> </tr> <tr> <td style="text-align: center;">30</td> <td style="text-align: center;">18</td> <td style="text-align: center;">23.2%</td> <td style="text-align: center;">0.0091 mm</td> </tr> <tr> <td style="text-align: center;">60</td> <td style="text-align: center;">15</td> <td style="text-align: center;">19.3%</td> <td style="text-align: center;">0.0065 mm</td> </tr> <tr> <td style="text-align: center;">240</td> <td style="text-align: center;">9</td> <td style="text-align: center;">11.6%</td> <td style="text-align: center;">0.0034 mm</td> </tr> <tr> <td style="text-align: center;">1440</td> <td style="text-align: center;">5.5</td> <td style="text-align: center;">7.1%</td> <td style="text-align: center;">0.0014 mm</td> </tr> </table> <table style="width: 100%;"> <tr> <td><b>% Gravel:</b></td> <td style="text-align: right;">0.0%</td> <td><b>Liquid Limit:</b></td> <td style="text-align: right;">n/a</td> </tr> <tr> <td><b>% Sand:</b></td> <td style="text-align: right;">21.5%</td> <td><b>Plastic Limit:</b></td> <td style="text-align: right;">n/a</td> </tr> <tr> <td><b>% Silt:</b></td> <td style="text-align: right;">63.0%</td> <td><b>Plasticity Index:</b></td> <td style="text-align: right;">n/a</td> </tr> <tr> <td><b>% Clay:</b></td> <td style="text-align: right;">15.5%</td> <td></td> <td></td> </tr> </table>	<b>Assumed Sp Gr :</b>	2.65		<b>Sample Weight:</b>	75.15	grams	<b>Hydroscopic Moist.:</b>	3.83%		<b>Adj. Sample Wgt :</b>	72.38	grams	<b>Hydrometer</b>				<b>Reading</b>	<b>Corrected</b>	<b>Percent</b>	<b>Soils Particle</b>	<b>Minutes</b>	<b>Reading</b>	<b>Passing</b>	<b>Diameter</b>	1	43	55.4%	0.0414 mm	2	38	49.0%	0.0307 mm	5	31	40.0%	0.0204 mm	15	21	27.1%	0.0127 mm	30	18	23.2%	0.0091 mm	60	15	19.3%	0.0065 mm	240	9	11.6%	0.0034 mm	1440	5.5	7.1%	0.0014 mm	<b>% Gravel:</b>	0.0%	<b>Liquid Limit:</b>	n/a	<b>% Sand:</b>	21.5%	<b>Plastic Limit:</b>	n/a	<b>% Silt:</b>	63.0%	<b>Plasticity Index:</b>	n/a	<b>% Clay:</b>	15.5%			<table style="width: 100%;"> <tr> <td colspan="3" style="text-align: center;"><b>Sieve Analysis</b></td> </tr> <tr> <td colspan="3" style="text-align: center;"><b>Grain Size Distribution</b></td> </tr> <tr> <td style="text-align: center;"><b>Sieve Size</b></td> <td style="text-align: center;"><b>Percent Passing</b></td> <td style="text-align: center;"><b>Soils Particle Diameter</b></td> </tr> <tr><td style="text-align: center;">3.0"</td><td style="text-align: center;">100%</td><td style="text-align: center;">75.000 mm</td></tr> <tr><td style="text-align: center;">2.0"</td><td style="text-align: center;">100%</td><td style="text-align: center;">50.000 mm</td></tr> <tr><td style="text-align: center;">1.5"</td><td style="text-align: center;">100%</td><td style="text-align: center;">37.500 mm</td></tr> <tr><td style="text-align: center;">1.25"</td><td style="text-align: center;">100%</td><td style="text-align: center;">31.500 mm</td></tr> <tr><td style="text-align: center;">1.0"</td><td style="text-align: center;">100%</td><td style="text-align: center;">25.000 mm</td></tr> <tr><td style="text-align: center;">3/4"</td><td style="text-align: center;">100%</td><td style="text-align: center;">19.000 mm</td></tr> <tr><td style="text-align: center;">5/8"</td><td style="text-align: center;">100%</td><td style="text-align: center;">16.000 mm</td></tr> <tr><td style="text-align: center;">1/2"</td><td style="text-align: center;">100%</td><td style="text-align: center;">12.500 mm</td></tr> <tr><td style="text-align: center;">3/8"</td><td style="text-align: center;">100%</td><td style="text-align: center;">9.500 mm</td></tr> <tr><td style="text-align: center;">1/4"</td><td style="text-align: center;">100%</td><td style="text-align: center;">6.300 mm</td></tr> <tr><td style="text-align: center;">#4</td><td style="text-align: center;">100%</td><td style="text-align: center;">4.750 mm</td></tr> <tr><td style="text-align: center;">#10</td><td style="text-align: center;">93%</td><td style="text-align: center;">2.000 mm</td></tr> <tr><td style="text-align: center;">#20</td><td style="text-align: center;">93%</td><td style="text-align: center;">0.850 mm</td></tr> <tr><td style="text-align: center;">#40</td><td style="text-align: center;">92%</td><td style="text-align: center;">0.425 mm</td></tr> <tr><td style="text-align: center;">#100</td><td style="text-align: center;">90%</td><td style="text-align: center;">0.150 mm</td></tr> <tr><td style="text-align: center;">#200</td><td style="text-align: center;">78.5%</td><td style="text-align: center;">0.075 mm</td></tr> <tr><td style="text-align: center;"><b>Silts</b></td><td style="text-align: center;">77.8%</td><td style="text-align: center;">0.074 mm</td></tr> <tr><td></td><td style="text-align: center;">65.5%</td><td style="text-align: center;">0.050 mm</td></tr> <tr><td></td><td style="text-align: center;">39.3%</td><td style="text-align: center;">0.020 mm</td></tr> <tr><td style="text-align: center;"><b>Clays</b></td><td style="text-align: center;">15.5%</td><td style="text-align: center;">0.005 mm</td></tr> <tr><td></td><td style="text-align: center;">8.4%</td><td style="text-align: center;">0.002 mm</td></tr> <tr><td style="text-align: center;"><b>Colloids</b></td><td style="text-align: center;">5.0%</td><td style="text-align: center;">0.001 mm</td></tr> </table>	<b>Sieve Analysis</b>			<b>Grain Size Distribution</b>			<b>Sieve Size</b>	<b>Percent Passing</b>	<b>Soils Particle Diameter</b>	3.0"	100%	75.000 mm	2.0"	100%	50.000 mm	1.5"	100%	37.500 mm	1.25"	100%	31.500 mm	1.0"	100%	25.000 mm	3/4"	100%	19.000 mm	5/8"	100%	16.000 mm	1/2"	100%	12.500 mm	3/8"	100%	9.500 mm	1/4"	100%	6.300 mm	#4	100%	4.750 mm	#10	93%	2.000 mm	#20	93%	0.850 mm	#40	92%	0.425 mm	#100	90%	0.150 mm	#200	78.5%	0.075 mm	<b>Silts</b>	77.8%	0.074 mm		65.5%	0.050 mm		39.3%	0.020 mm	<b>Clays</b>	15.5%	0.005 mm		8.4%	0.002 mm	<b>Colloids</b>	5.0%	0.001 mm
<b>Assumed Sp Gr :</b>	2.65																																																																																																																																																			
<b>Sample Weight:</b>	75.15	grams																																																																																																																																																		
<b>Hydroscopic Moist.:</b>	3.83%																																																																																																																																																			
<b>Adj. Sample Wgt :</b>	72.38	grams																																																																																																																																																		
<b>Hydrometer</b>																																																																																																																																																				
<b>Reading</b>	<b>Corrected</b>	<b>Percent</b>	<b>Soils Particle</b>																																																																																																																																																	
<b>Minutes</b>	<b>Reading</b>	<b>Passing</b>	<b>Diameter</b>																																																																																																																																																	
1	43	55.4%	0.0414 mm																																																																																																																																																	
2	38	49.0%	0.0307 mm																																																																																																																																																	
5	31	40.0%	0.0204 mm																																																																																																																																																	
15	21	27.1%	0.0127 mm																																																																																																																																																	
30	18	23.2%	0.0091 mm																																																																																																																																																	
60	15	19.3%	0.0065 mm																																																																																																																																																	
240	9	11.6%	0.0034 mm																																																																																																																																																	
1440	5.5	7.1%	0.0014 mm																																																																																																																																																	
<b>% Gravel:</b>	0.0%	<b>Liquid Limit:</b>	n/a																																																																																																																																																	
<b>% Sand:</b>	21.5%	<b>Plastic Limit:</b>	n/a																																																																																																																																																	
<b>% Silt:</b>	63.0%	<b>Plasticity Index:</b>	n/a																																																																																																																																																	
<b>% Clay:</b>	15.5%																																																																																																																																																			
<b>Sieve Analysis</b>																																																																																																																																																				
<b>Grain Size Distribution</b>																																																																																																																																																				
<b>Sieve Size</b>	<b>Percent Passing</b>	<b>Soils Particle Diameter</b>																																																																																																																																																		
3.0"	100%	75.000 mm																																																																																																																																																		
2.0"	100%	50.000 mm																																																																																																																																																		
1.5"	100%	37.500 mm																																																																																																																																																		
1.25"	100%	31.500 mm																																																																																																																																																		
1.0"	100%	25.000 mm																																																																																																																																																		
3/4"	100%	19.000 mm																																																																																																																																																		
5/8"	100%	16.000 mm																																																																																																																																																		
1/2"	100%	12.500 mm																																																																																																																																																		
3/8"	100%	9.500 mm																																																																																																																																																		
1/4"	100%	6.300 mm																																																																																																																																																		
#4	100%	4.750 mm																																																																																																																																																		
#10	93%	2.000 mm																																																																																																																																																		
#20	93%	0.850 mm																																																																																																																																																		
#40	92%	0.425 mm																																																																																																																																																		
#100	90%	0.150 mm																																																																																																																																																		
#200	78.5%	0.075 mm																																																																																																																																																		
<b>Silts</b>	77.8%	0.074 mm																																																																																																																																																		
	65.5%	0.050 mm																																																																																																																																																		
	39.3%	0.020 mm																																																																																																																																																		
<b>Clays</b>	15.5%	0.005 mm																																																																																																																																																		
	8.4%	0.002 mm																																																																																																																																																		
<b>Colloids</b>	5.0%	0.001 mm																																																																																																																																																		
<b>USDA Soil Textural Classification</b>																																																																																																																																																				
<table style="width: 100%;"> <tr> <td></td> <td style="text-align: center;"><b>Particle Size</b></td> </tr> <tr> <td><b>% Sand:</b></td> <td style="text-align: center;">2.0 - 0.05 mm</td> </tr> <tr> <td><b>% Silt:</b></td> <td style="text-align: center;">0.05 - 0.002 mm</td> </tr> <tr> <td><b>% Clay:</b></td> <td style="text-align: center;">&lt; 0.002 mm</td> </tr> </table> <p style="text-align: center;"><b>USDA Soil Textural Classification</b> Silt Loam</p>		<b>Particle Size</b>	<b>% Sand:</b>	2.0 - 0.05 mm	<b>% Silt:</b>	0.05 - 0.002 mm	<b>% Clay:</b>	< 0.002 mm																																																																																																																																												
	<b>Particle Size</b>																																																																																																																																																			
<b>% Sand:</b>	2.0 - 0.05 mm																																																																																																																																																			
<b>% Silt:</b>	0.05 - 0.002 mm																																																																																																																																																			
<b>% Clay:</b>	< 0.002 mm																																																																																																																																																			

All results apply only to actual locations and materials tested. As a mutual protection to clients, the public and ourselves, all reports are submitted as the confidential property of clients, and authorization for publication of statements, conclusions or extracts from or regarding our reports is reserved pending our written approval.

**Comments:** \_\_\_\_\_  
 \_\_\_\_\_  
 \_\_\_\_\_

**Reviewed by:**   
 \_\_\_\_\_  
 Meghan Blodgett-Carrillo

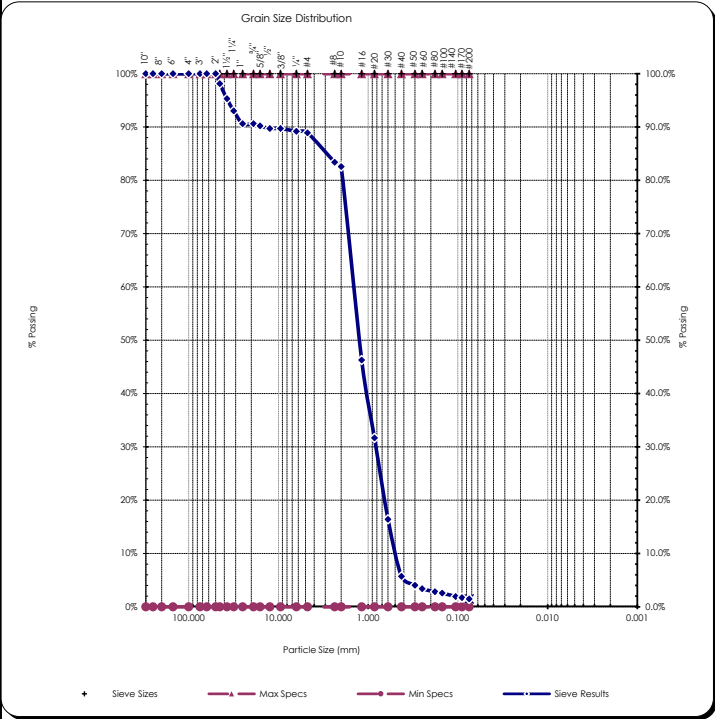


# Sieve Report

<b>Project:</b> Q.C. - Lower Duwamish Waterway <b>Project #:</b> 21B233 <b>Client:</b> Anchor QEA <b>Source:</b> LDW21-GT44-GB-25-28.7 ft <b>Sample#:</b> B21-2060	<b>Date Received:</b> 29-Jul-21 <b>Sampled By:</b> Client <b>Date Tested:</b> 8-Oct-21 <b>Tested By:</b> A. Eifrig	<b>Unified Soils Classification System, ASTM D-2487</b> SP, Poorly graded Sand <b>Sample Color:</b> brown	 Certificate #: 1366.01
--	---	--	----------------------------

<b>ASTM D2216, ASTM D2419, ASTM D4318, ASTM D5281</b>			
<b>Specifications</b> No Specs <b>Sample Meets Specs ?</b> N/A	D <sub>(5)</sub> = 0.370 mm D <sub>(10)</sub> = 0.495 mm D <sub>(15)</sub> = 0.577 mm D <sub>(30)</sub> = 0.822 mm D <sub>(50)</sub> = 1.264 mm D <sub>(60)</sub> = 1.490 mm D <sub>(90)</sub> = 14.510 mm Dust Ratio = 6/23	% Gravel = 11.1% % Sand = 87.4% % Silt & Clay = 1.5% Liquid Limit = n/a Plasticity Index = n/a Sand Equivalent = n/a Fracture %, 1 Face = n/a Fracture %, 2+ Faces = n/a	Coeff. of Curvature, C <sub>c</sub> = 0.92 Coeff. of Uniformity, C <sub>u</sub> = 3.01 Fineness Modulus = 3.78 Plastic Limit = n/a Moisture %, as sampled = 14.2% Req'd Sand Equivalent = Req'd Fracture %, 1 Face = Req'd Fracture %, 2+ Faces =

<b>ASTM C136, ASTM D6913, ASTM C117</b>					
Sieve Size		Actual Cumulative Percent Passing	Interpolated Cumulative Percent Passing	Specs Max	Specs Min
US	Metric				
12.00"	300.00		100%	100.0%	0.0%
10.00"	250.00		100%	100.0%	0.0%
8.00"	200.00		100%	100.0%	0.0%
6.00"	150.00		100%	100.0%	0.0%
4.00"	100.00		100%	100.0%	0.0%
3.00"	75.00		100%	100.0%	0.0%
2.50"	63.00		100%	100.0%	0.0%
2.00"	50.00	100%	100%	100.0%	0.0%
1.75"	45.00		98%	100.0%	0.0%
1.50"	37.50		95%	100.0%	0.0%
1.25"	31.50		93%	100.0%	0.0%
1.00"	25.00	91%	91%	100.0%	0.0%
3/4"	19.00	91%	91%	100.0%	0.0%
5/8"	16.00		90%	100.0%	0.0%
1/2"	12.50	90%	90%	100.0%	0.0%
3/8"	9.50	90%	90%	100.0%	0.0%
1/4"	6.30		89%	100.0%	0.0%
#4	4.75	89%	89%	100.0%	0.0%
#8	2.36		83%	100.0%	0.0%
#10	2.00	83%	83%	100.0%	0.0%
#16	1.18		46%	100.0%	0.0%
#20	0.850	32%	32%	100.0%	0.0%
#30	0.600		16%	100.0%	0.0%
#40	0.425	6%	6%	100.0%	0.0%
#50	0.300		4%	100.0%	0.0%
#60	0.250	3%	3%	100.0%	0.0%
#80	0.180		3%	100.0%	0.0%
#100	0.150	3%	3%	100.0%	0.0%
#140	0.106		2%	100.0%	0.0%
#170	0.090		2%	100.0%	0.0%
#200	0.075	1.5%	1.5%	100.0%	0.0%



Copyright Spears Engineering & Technical Services PS, 1996-98  
 All results apply only to actual locations and materials tested. As a mutual protection to clients, the public and ourselves, all reports are submitted as the confidential property of clients, and authorization for publication of statements, conclusions or extracts from or regarding our reports is reserved pending our written approval.

**Comments:** \_\_\_\_\_

Reviewed by:   
 Meghan Blodgett-Carrillo



# Sieve Report

<b>Project:</b> Q.C. - Lower Duwamish Waterway <b>Project #:</b> 21B233 <b>Client:</b> Anchor QEA <b>Source:</b> LDW21-GT44-GB-28.7-30 ft <b>Sample#:</b> B21-2061	<b>Date Received:</b> 29-Jul-21 <b>Sampled By:</b> Client <b>Date Tested:</b> 8-Oct-21 <b>Tested By:</b> A. Eifrig	<b>Visual Identification</b> Sandy Silt <b>Sample Color:</b> brown	ACCREDITED Certificate #: 1366.01
--	---	---	--------------------------------------

**ASTM D2216, ASTM D2419, ASTM D4318, ASTM D5281**

**Specifications**

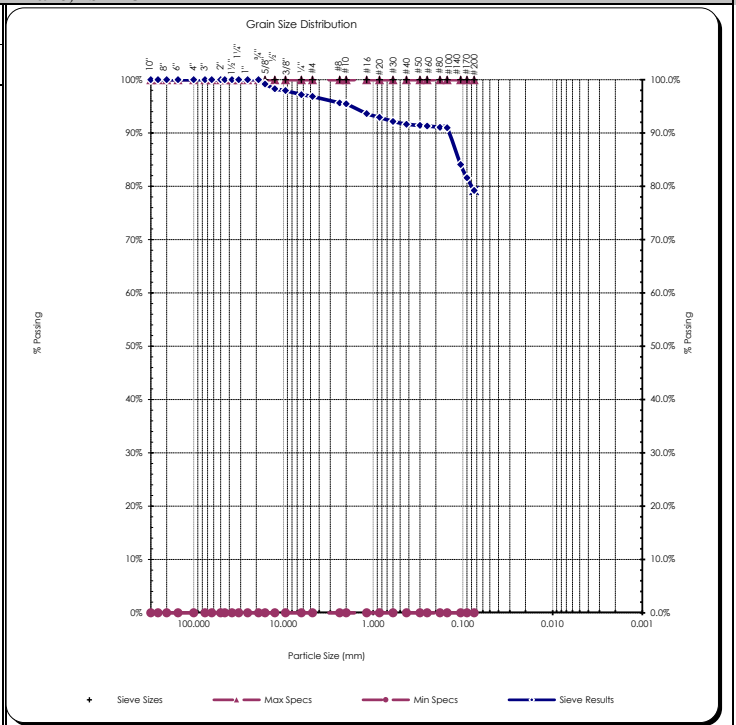
No Specs

**Sample Meets Specs ? N/A**

D <sub>(5)</sub> = 0.005 mm	% Gravel = 3.2%	Coeff. of Curvature, C <sub>c</sub> = 1.50
D <sub>(10)</sub> = 0.009 mm	% Sand = 17.6%	Coeff. of Uniformity, C <sub>u</sub> = 6.00
D <sub>(15)</sub> = 0.014 mm	% Silt & Clay = 79.2%	Fineness Modulus = 0.41
D <sub>(30)</sub> = 0.028 mm	Liquid Limit = n/a	Plastic Limit = n/a
D <sub>(50)</sub> = 0.047 mm	Plasticity Index = n/a	Moisture %, as sampled = 37.0%
D <sub>(60)</sub> = 0.057 mm	Sand Equivalent = n/a	Req'd Sand Equivalent =
D <sub>(90)</sub> = 0.144 mm	Fracture %, 1 Face = n/a	Req'd Fracture %, 1 Face =
Dust Ratio = 51/59	Fracture %, 2+ Faces = n/a	Req'd Fracture %, 2+ Faces =

**ASTM C136, ASTM D6913, ASTM C117**

Sieve Size		Actual Cumulative Percent Passing	Interpolated Cumulative Percent Passing	Specs Max	Specs Min
US	Metric				
12.00"	300.00		100%	100.0%	0.0%
10.00"	250.00		100%	100.0%	0.0%
8.00"	200.00		100%	100.0%	0.0%
6.00"	150.00		100%	100.0%	0.0%
4.00"	100.00		100%	100.0%	0.0%
3.00"	75.00		100%	100.0%	0.0%
2.50"	63.00		100%	100.0%	0.0%
2.00"	50.00	100%	100%	100.0%	0.0%
1.75"	45.00		100%	100.0%	0.0%
1.50"	37.50		100%	100.0%	0.0%
1.25"	31.50		100%	100.0%	0.0%
1.00"	25.00	100%	100%	100.0%	0.0%
3/4"	19.00	100%	100%	100.0%	0.0%
5/8"	16.00		99%	100.0%	0.0%
1/2"	12.50	98%	98%	100.0%	0.0%
3/8"	9.50	98%	98%	100.0%	0.0%
1/4"	6.30		97%	100.0%	0.0%
#4	4.75	97%	97%	100.0%	0.0%
#8	2.36		96%	100.0%	0.0%
#10	2.00	95%	95%	100.0%	0.0%
#16	1.18		94%	100.0%	0.0%
#20	0.850	93%	93%	100.0%	0.0%
#30	0.600		92%	100.0%	0.0%
#40	0.425	92%	92%	100.0%	0.0%
#50	0.300		91%	100.0%	0.0%
#60	0.250	91%	91%	100.0%	0.0%
#80	0.180		91%	100.0%	0.0%
#100	0.150	91%	91%	100.0%	0.0%
#140	0.106		84%	100.0%	0.0%
#170	0.090		82%	100.0%	0.0%
#200	0.075	79.2%	79.2%	100.0%	0.0%



Copyright Spears Engineering & Technical Services PS, 1996-98

All results apply only to actual locations and materials tested. As a mutual protection to clients, the public and ourselves, all reports are submitted as the confidential property of clients, and authorization for publication of statements, conclusions or extracts from or regarding our reports is reserved pending our written approval.

**Comments:** \_\_\_\_\_

Reviewed by: \_\_\_\_\_  
 Meghan Blodgett-Carrillo



# Direct Shear Test Results:

ASTM D-3080



Project: Q.C. - Lower Duwamish Waterway  
 Project Number: 21B233  
 Laboratory Sample ID: B21-2065  
 Sample Date: 8/5/2021  
 Test Date: 10/15/2021  
 Technician: M. Carrillo

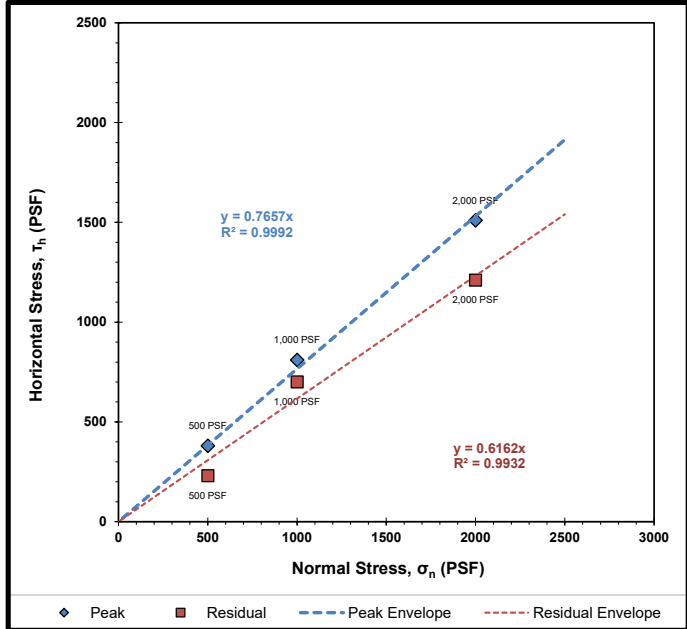
Sample Source: LDW21-GT48-GB-5-10 ft  
 Visual Soil Description: brown silty sand with gravel  
 Type of Specimen: Remolded Cylindrical Shear Box  
 Specimen Diameter (in): 2.5  
 Specimen Height (in): 1  
 Rate of Strain (in/min): 0.0208  
 Estimated Specific Gravity of Solids: 2.65

Summary of Sample Data: $\sigma_n=500$ PSF		
	Initial Moisture Content (%)	
	Initial	Post-Consolidation
Dry Density (PCF):	-4530.4	-4603.6
Void Ratio:	-1.037	-1.037
Porosity (%):	2789.0	2832.4
Degree of Saturation (%):	-97.6	saturated

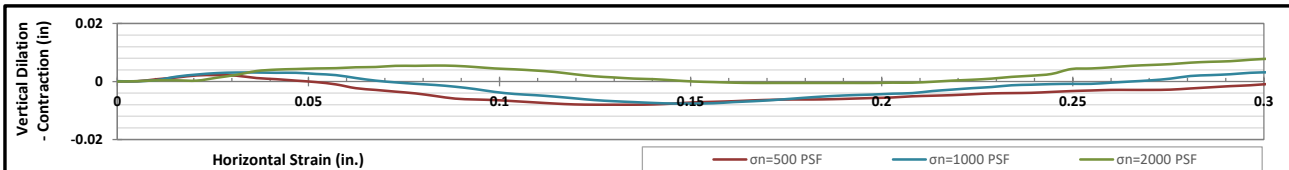
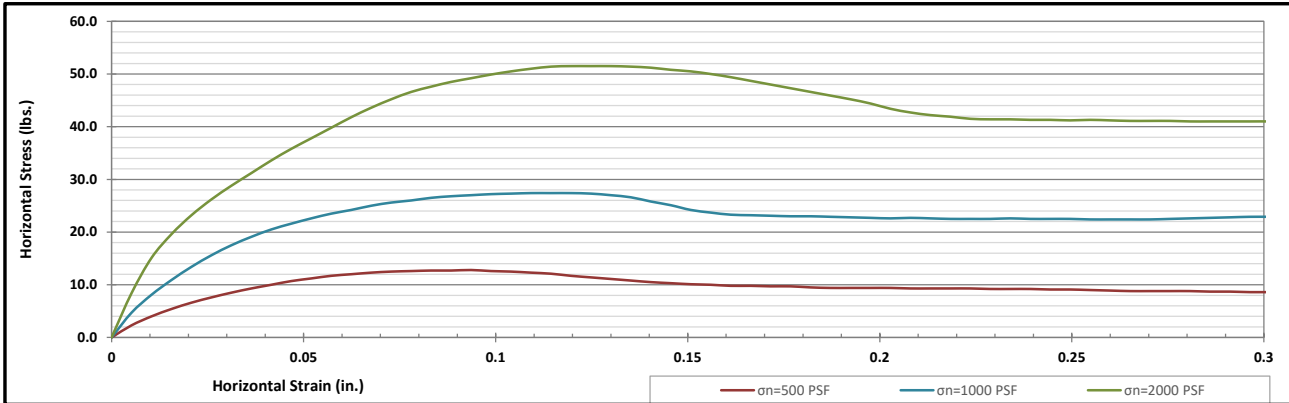
Summary of Sample Data: $\sigma_n=1000$ PSF		
	Initial Moisture Content (%)	
	Initial	Post-Consolidation
Dry Density (PCF):	100.8	104.7
Void Ratio:	0.672	0.610
Porosity (%):	40.2	37.9
Degree of Saturation (%):	saturated	saturated

Summary of Sample Data: $\sigma_n=2000$ PSF		
	Initial Moisture Content (%)	
	Initial	Post-Consolidation
Dry Density (PCF):	100.6	106.4
Void Ratio:	0.675	0.584
Porosity (%):	40.3	36.9
Degree of Saturation (%):	saturated	saturated

ESTIMATED STRENGTH PARAMETERS		
	PEAK	RESIDUAL
Angle of Internal Friction, $\phi$ (°):	37	32
Cohesion (PSF):	0	0



Failure Envelope Test Values:			
Normal Stress, $\sigma_n$ (PSF):	500	1000	2000
Peak Horizontal Stress, $\tau_h$ (PSF):	380	810	1510
Residual Horizontal Stress, $\tau_r$ (PSF):	230	700	1210



Corporate • 777 Chrysler Drive • Burlington, WA 98233 • Phone 360.755.1990 • Fax 360.755.1980  
 SW Region • 2118 Black Lake Blvd. S.W. • Olympia, WA 98512 • Phone 360.534.9777 • Fax 360.534.9779  
 NW Region • 805 Dupont, Suite #5 • Bellingham, WA 98225 • Phone 360.647.6061 • Fax 360.647.8111  
 Kitsap Region • 5451 N.W. Newberry Hill Road, Suite 101 • Silverdale, WA 98383 • Phone/Fax 360.698.6787

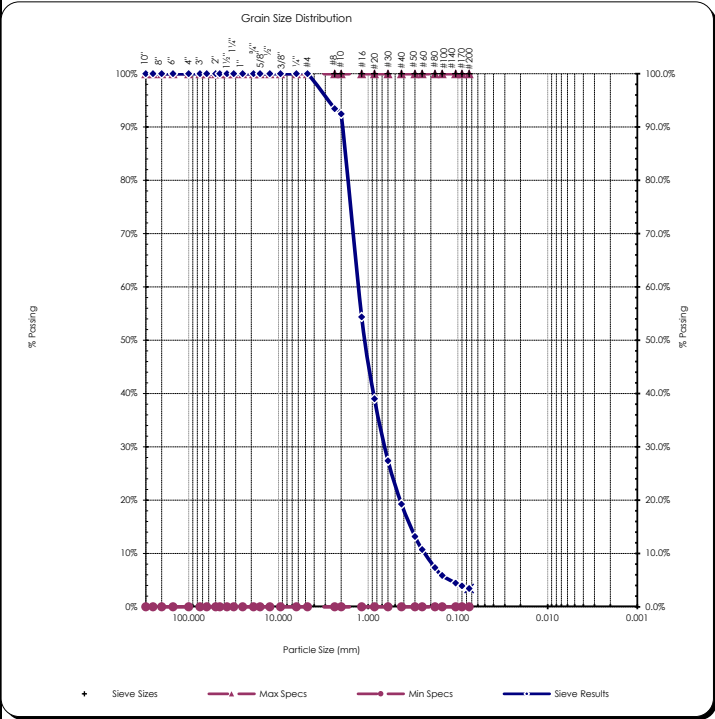
Visit our website: [www.mtc-inc.net](http://www.mtc-inc.net)

# Sieve Report

<b>Project:</b> Q.C. - Lower Duwamish Waterway <b>Project #:</b> 21B233 <b>Client:</b> Anchor QEA <b>Source:</b> LDW21-GT48-GB-0-5 ft <b>Sample#:</b> B21-2063	<b>Date Received:</b> 29-Jul-21 <b>Sampled By:</b> Client <b>Date Tested:</b> 8-Oct-21 <b>Tested By:</b> A. Eifrig	<b>Unified Soils Classification System, ASTM D-2487</b> SP, Poorly graded Sand <b>Sample Color:</b> brown	 <b>ACCREDITED</b> Certificate #: 1366.01
--	---	--	---

<b>ASTM D2216, ASTM D2419, ASTM D4318, ASTM D5281</b>			
<b>Specifications</b> No Specs <b>Sample Meets Specs ?</b> N/A	D <sub>(5)</sub> = 0.123 mm D <sub>(10)</sub> = 0.234 mm D <sub>(15)</sub> = 0.337 mm D <sub>(30)</sub> = 0.655 mm D <sub>(50)</sub> = 1.086 mm D <sub>(60)</sub> = 1.301 mm D <sub>(90)</sub> = 1.947 mm Dust Ratio = 7/39	% Gravel = 0.0% % Sand = 96.5% % Silt & Clay = 3.5% Liquid Limit = n/a Plasticity Index = n/a Sand Equivalent = n/a Fracture %, 1 Face = n/a Fracture %, 2+ Faces = n/a	Coeff. of Curvature, C <sub>c</sub> = 1.41 Coeff. of Uniformity, C <sub>u</sub> = 5.55 Fineness Modulus = 3.06 Plastic Limit = n/a Moisture %, as sampled = 22.2% Req'd Sand Equivalent = Req'd Fracture %, 1 Face = Req'd Fracture %, 2+ Faces =

<b>ASTM C136, ASTM D6913, ASTM C117</b>					
Sieve Size		Actual Cumulative Percent Passing	Interpolated Cumulative Percent Passing	Specs Max	Specs Min
US	Metric				
12.00"	300.00		100%	100.0%	0.0%
10.00"	250.00		100%	100.0%	0.0%
8.00"	200.00		100%	100.0%	0.0%
6.00"	150.00		100%	100.0%	0.0%
4.00"	100.00		100%	100.0%	0.0%
3.00"	75.00		100%	100.0%	0.0%
2.50"	63.00		100%	100.0%	0.0%
2.00"	50.00	100%	100%	100.0%	0.0%
1.75"	45.00	100%	100%	100.0%	0.0%
1.50"	37.50	100%	100%	100.0%	0.0%
1.25"	31.50	100%	100%	100.0%	0.0%
1.00"	25.00	100%	100%	100.0%	0.0%
3/4"	19.00	100%	100%	100.0%	0.0%
5/8"	16.00	100%	100%	100.0%	0.0%
1/2"	12.50	100%	100%	100.0%	0.0%
3/8"	9.50	100%	100%	100.0%	0.0%
1/4"	6.30	100%	100%	100.0%	0.0%
#4	4.75	100%	100%	100.0%	0.0%
#8	2.36		93%	100.0%	0.0%
#10	2.00	92%	92%	100.0%	0.0%
#16	1.18		54%	100.0%	0.0%
#20	0.850		39%	100.0%	0.0%
#30	0.600		27%	100.0%	0.0%
#40	0.425	19%	19%	100.0%	0.0%
#50	0.300		13%	100.0%	0.0%
#60	0.250		11%	100.0%	0.0%
#80	0.180		7%	100.0%	0.0%
#100	0.150	6%	6%	100.0%	0.0%
#140	0.106		4%	100.0%	0.0%
#170	0.090		4%	100.0%	0.0%
#200	0.075	3.5%	3.5%	100.0%	0.0%



Copyright Spears Engineering & Technical Services PS, 1996-98  
 All results apply only to actual locations and materials tested. As a mutual protection to clients, the public and ourselves, all reports are submitted as the confidential property of clients, and authorization for publication of statements, conclusions or extracts from or regarding our reports is reserved pending our written approval.

**Comments:** \_\_\_\_\_

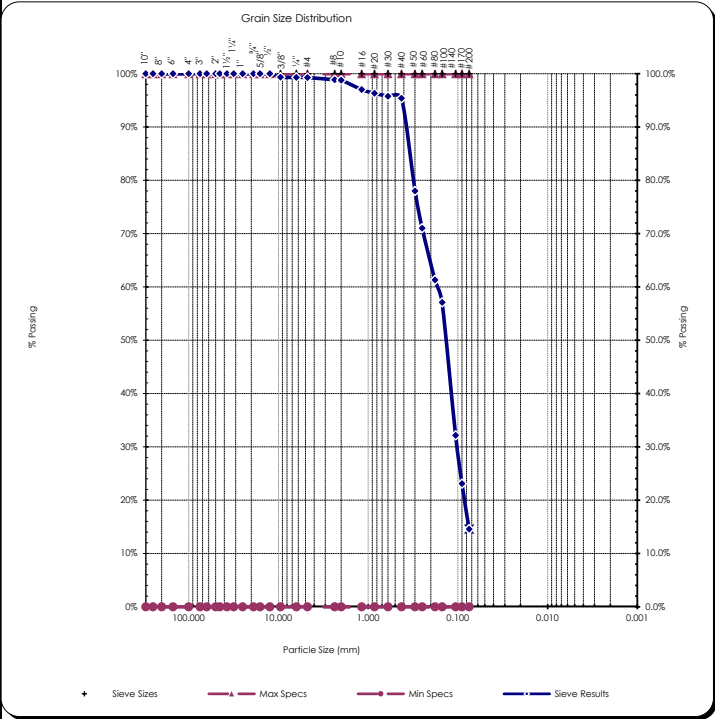
Reviewed by:   
 Meghan Blodgett-Carrillo

# Sieve Report

<b>Project:</b> Q.C. - Lower Duwamish Waterway <b>Project #:</b> 21B233 <b>Client:</b> Anchor QEA <b>Source:</b> LDW21-GT48-GB-5-10 ft <b>Sample#:</b> B21-2065	<b>Date Received:</b> 29-Jul-21 <b>Sampled By:</b> Client <b>Date Tested:</b> 8-Oct-21 <b>Tested By:</b> A. Eifrig	<b>Unified Soils Classification System, ASTM D-2487</b> SM, Silty Sand <b>Sample Color:</b> brown	 <b>ACCREDITED</b> Certificate #: 1366.01
---	---	--	---

<b>ASTM D2216, ASTM D2419, ASTM D4318, ASTM D5281</b>			
<b>Specifications</b> No Specs <b>Sample Meets Specs ?</b> N/A	D <sub>(5)</sub> = 0.026 mm D <sub>(10)</sub> = 0.051 mm D <sub>(15)</sub> = 0.076 mm D <sub>(30)</sub> = 0.102 mm D <sub>(50)</sub> = 0.137 mm D <sub>(60)</sub> = 0.171 mm D <sub>(90)</sub> = 0.386 mm Dust Ratio = 15/98	% Gravel = 0.7% % Sand = 84.7% % Silt & Clay = 14.6% Liquid Limit = n/a Plasticity Index = n/a Sand Equivalent = n/a Fracture %, 1 Face = n/a Fracture %, 2+ Faces = n/a	Coeff. of Curvature, C <sub>c</sub> = 1.19 Coeff. of Uniformity, C <sub>u</sub> = 3.32 Fineness Modulus = 0.75 Plastic Limit = n/a Moisture %, as sampled = 39.5% Req'd Sand Equivalent = Req'd Fracture %, 1 Face = Req'd Fracture %, 2+ Faces =

<b>ASTM C136, ASTM D6913, ASTM C117</b>					
Sieve Size		Actual Cumulative Percent Passing	Interpolated Cumulative Percent Passing	Specs Max	Specs Min
US	Metric				
12.00"	300.00		100%	100.0%	0.0%
10.00"	250.00		100%	100.0%	0.0%
8.00"	200.00		100%	100.0%	0.0%
6.00"	150.00		100%	100.0%	0.0%
4.00"	100.00		100%	100.0%	0.0%
3.00"	75.00		100%	100.0%	0.0%
2.50"	63.00		100%	100.0%	0.0%
2.00"	50.00	100%	100%	100.0%	0.0%
1.75"	45.00	100%	100%	100.0%	0.0%
1.50"	37.50	100%	100%	100.0%	0.0%
1.25"	31.50	100%	100%	100.0%	0.0%
1.00"	25.00	100%	100%	100.0%	0.0%
3/4"	19.00	100%	100%	100.0%	0.0%
5/8"	16.00	100%	100%	100.0%	0.0%
1/2"	12.50	100%	100%	100.0%	0.0%
3/8"	9.50	99%	99%	100.0%	0.0%
1/4"	6.30	99%	99%	100.0%	0.0%
#4	4.75	99%	99%	100.0%	0.0%
#8	2.36	99%	99%	100.0%	0.0%
#10	2.00	99%	99%	100.0%	0.0%
#16	1.18	97%	97%	100.0%	0.0%
#20	0.850	96%	96%	100.0%	0.0%
#30	0.600	96%	96%	100.0%	0.0%
#40	0.425	95%	95%	100.0%	0.0%
#50	0.300	78%	78%	100.0%	0.0%
#60	0.250	71%	71%	100.0%	0.0%
#80	0.180	61%	61%	100.0%	0.0%
#100	0.150	57%	57%	100.0%	0.0%
#140	0.106	32%	32%	100.0%	0.0%
#170	0.090	23%	23%	100.0%	0.0%
#200	0.075	14.6%	14.6%	100.0%	0.0%



Copyright Spears Engineering & Technical Services PS, 1996-98

All results apply only to actual locations and materials tested. As a mutual protection to clients, the public and ourselves, all reports are submitted as the confidential property of clients, and authorization for publication of statements, conclusions or extracts from or regarding our reports is reserved pending our written approval.

**Comments:** \_\_\_\_\_

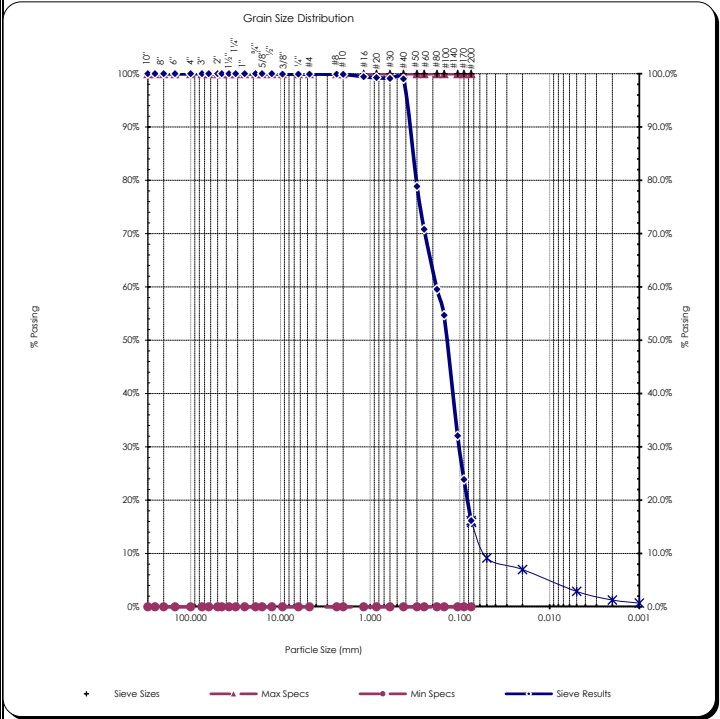
Reviewed by:   
 Meghan Blodgett-Carrillo

# Sieve Report

<b>Project:</b> Q.C. - Lower Duwamish Waterway <b>Project #:</b> 21B233 <b>Client:</b> Anchor QEA <b>Source:</b> LDW21-GT48-GB-10-15 ft <b>Sample#:</b> B21-2066	<b>Date Received:</b> 29-Jul-21 <b>Sampled By:</b> Client <b>Date Tested:</b> 8-Oct-21 <b>Tested By:</b> A. Eifrig	<b>Unified Soils Classification System, ASTM D-2487</b> SM, Silty Sand <b>Sample Color:</b> dark brown	 <b>ACCREDITED</b> Certificate #: 1366.01
--	---	---	---

<b>ASTM D2216, ASTM D2419, ASTM D4318, ASTM D5281</b>			
<b>Specifications</b> No Specs <b>Sample Meets Specs ? N/A</b>	D <sub>(5)</sub> = 0.009 mm D <sub>(10)</sub> = 0.056 mm D <sub>(15)</sub> = 0.071 mm D <sub>(30)</sub> = 0.102 mm D <sub>(50)</sub> = 0.141 mm D <sub>(60)</sub> = 0.183 mm D <sub>(90)</sub> = 0.369 mm Dust Ratio = 8/49	% Gravel = 0.1% % Sand = 83.7% % Silt & Clay = 16.2% Liquid Limit = n/a Plasticity Index = n/a Sand Equivalent = n/a Fracture %, 1 Face = n/a Fracture %, 2+ Faces = n/a	Coeff. of Curvature, C <sub>c</sub> = 1.02 Coeff. of Uniformity, C <sub>u</sub> = 3.29 Fineness Modulus = 0.68 Plastic Limit = n/a Moisture %, as sampled = 30.7% Req'd Sand Equivalent = Req'd Fracture %, 1 Face = Req'd Fracture %, 2+ Faces =

<b>ASTM C136, ASTM D6913, ASTM C117</b>					
Sieve Size		Actual Cumulative Percent Passing	Interpolated Cumulative Percent Passing	Specs Max	Specs Min
US	Metric				
12.00"	300.00		100%	100.0%	0.0%
10.00"	250.00		100%	100.0%	0.0%
8.00"	200.00		100%	100.0%	0.0%
6.00"	150.00		100%	100.0%	0.0%
4.00"	100.00		100%	100.0%	0.0%
3.00"	75.00		100%	100.0%	0.0%
2.50"	63.00		100%	100.0%	0.0%
2.00"	50.00	100%	100%	100.0%	0.0%
1.75"	45.00	100%	100%	100.0%	0.0%
1.50"	37.50	100%	100%	100.0%	0.0%
1.25"	31.50	100%	100%	100.0%	0.0%
1.00"	25.00	100%	100%	100.0%	0.0%
3/4"	19.00	100%	100%	100.0%	0.0%
5/8"	16.00	100%	100%	100.0%	0.0%
1/2"	12.50	100%	100%	100.0%	0.0%
3/8"	9.50	100%	100%	100.0%	0.0%
1/4"	6.30	100%	100%	100.0%	0.0%
#4	4.75	100%	100%	100.0%	0.0%
#8	2.36	100%	100%	100.0%	0.0%
#10	2.00	100%	100%	100.0%	0.0%
#16	1.18	99%	99%	100.0%	0.0%
#20	0.850	99%	99%	100.0%	0.0%
#30	0.600	99%	99%	100.0%	0.0%
#40	0.425	99%	99%	100.0%	0.0%
#50	0.300	79%	79%	100.0%	0.0%
#60	0.250	71%	71%	100.0%	0.0%
#80	0.180	60%	60%	100.0%	0.0%
#100	0.150	55%	55%	100.0%	0.0%
#140	0.106	32%	32%	100.0%	0.0%
#170	0.090	24%	24%	100.0%	0.0%
#200	0.075	16.2%	16.2%	100.0%	0.0%



Copyright Spears Engineering & Technical Services PS, 1996-98  
 All results apply only to actual locations and materials tested. As a mutual protection to clients, the public and ourselves, all reports are submitted as the confidential property of clients, and authorization for publication of statements, conclusions or extracts from or regarding our reports is reserved pending our written approval.

**Comments:** \_\_\_\_\_

Reviewed by:   
 Meghan Blodgett-Carrillo

## Hydrometer Report

<p><b>Project:</b> Q.C. - Lower Duwamish Waterway    <b>Date Received:</b> 29-Jul-21  <b>Project #:</b> 21B233    <b>Sampled By:</b> Client  <b>Client:</b> Anchor QEA    <b>Date Tested:</b> 8-Oct-21  <b>Source:</b> LDW21-GT48-GB-10-15 ft    <b>Tested By:</b> A. Eifrig  <b>Sample#:</b> B21-2066</p>	<p><b>Unified Soils Classification System, ASTM D-2487</b>  SM, Silty Sand  <b>Sample Color</b>  dark brown</p>																																																																																																									
<b>ASTM D7928, HYDROMETER ANALYSIS</b>	<b>ASTM D6913</b>																																																																																																									
<p>Sp Gr : 2.62  Sample Weight: 100.83 grams  Hydroscopic Moist.: 3.02%  Adj. Sample Wgt : 97.87 grams</p> <div style="text-align: center;"> </div> <table style="width: 100%; border-collapse: collapse; margin-top: 10px;"> <thead> <tr> <th style="text-align: left;">Hydrometer Reading</th> <th style="text-align: left;">Corrected Reading</th> <th style="text-align: left;">Percent Passing</th> <th style="text-align: left;">Soils Particle Diameter</th> </tr> </thead> <tbody> <tr><td>1</td><td>9</td><td>9.3%</td><td>0.0533 mm</td></tr> <tr><td>2</td><td>8</td><td>8.2%</td><td>0.0380 mm</td></tr> <tr><td>5</td><td>7</td><td>7.2%</td><td>0.0242 mm</td></tr> <tr><td>15</td><td>6.5</td><td>6.7%</td><td>0.0140 mm</td></tr> <tr><td>30</td><td>5.5</td><td>5.7%</td><td>0.0100 mm</td></tr> <tr><td>60</td><td>4</td><td>4.1%</td><td>0.0071 mm</td></tr> <tr><td>240</td><td>2</td><td>2.1%</td><td>0.0036 mm</td></tr> <tr><td>1440</td><td>1</td><td>1.0%</td><td>0.0015 mm</td></tr> </tbody> </table> <p style="margin-top: 10px;"> <b>% Gravel:</b> 0.1%                      <b>Liquid Limit:</b> n/a  <b>% Sand:</b> 83.7%                      <b>Plastic Limit:</b> n/a  <b>% Silt:</b> 13.3%                      <b>Plasticity Index:</b> n/a  <b>% Clay:</b> 2.9% </p>	Hydrometer Reading	Corrected Reading	Percent Passing	Soils Particle Diameter	1	9	9.3%	0.0533 mm	2	8	8.2%	0.0380 mm	5	7	7.2%	0.0242 mm	15	6.5	6.7%	0.0140 mm	30	5.5	5.7%	0.0100 mm	60	4	4.1%	0.0071 mm	240	2	2.1%	0.0036 mm	1440	1	1.0%	0.0015 mm	<p style="text-align: center;">Sieve Analysis Grain Size Distribution</p> <table style="width: 100%; border-collapse: collapse;"> <thead> <tr> <th style="text-align: left;">Sieve Size</th> <th style="text-align: left;">Percent Passing</th> <th style="text-align: left;">Soils Particle Diameter</th> </tr> </thead> <tbody> <tr><td>3.0"</td><td>100%</td><td>75.000 mm</td></tr> <tr><td>2.0"</td><td>100%</td><td>50.000 mm</td></tr> <tr><td>1.5"</td><td>100%</td><td>37.500 mm</td></tr> <tr><td>1.25"</td><td>100%</td><td>31.500 mm</td></tr> <tr><td>1.0"</td><td>100%</td><td>25.000 mm</td></tr> <tr><td>3/4"</td><td>100%</td><td>19.000 mm</td></tr> <tr><td>5/8"</td><td>100%</td><td>16.000 mm</td></tr> <tr><td>1/2"</td><td>100%</td><td>12.500 mm</td></tr> <tr><td>3/8"</td><td>100%</td><td>9.500 mm</td></tr> <tr><td>1/4"</td><td>100%</td><td>6.300 mm</td></tr> <tr><td>#4</td><td>100%</td><td>4.750 mm</td></tr> <tr><td>#10</td><td>100%</td><td>2.000 mm</td></tr> <tr><td>#20</td><td>99%</td><td>0.850 mm</td></tr> <tr><td>#40</td><td>99%</td><td>0.425 mm</td></tr> <tr><td>#100</td><td>55%</td><td>0.150 mm</td></tr> <tr><td>#200</td><td>16.2%</td><td>0.075 mm</td></tr> <tr><td style="padding-left: 20px;"><b>Silts</b></td><td>15.9%</td><td>0.074 mm</td></tr> <tr><td></td><td>9.1%</td><td>0.050 mm</td></tr> <tr><td></td><td>7.0%</td><td>0.020 mm</td></tr> <tr><td style="padding-left: 20px;"><b>Clays</b></td><td>2.9%</td><td>0.005 mm</td></tr> <tr><td></td><td>1.3%</td><td>0.002 mm</td></tr> <tr><td style="padding-left: 20px;"><b>Colloids</b></td><td>0.7%</td><td>0.001 mm</td></tr> </tbody> </table>	Sieve Size	Percent Passing	Soils Particle Diameter	3.0"	100%	75.000 mm	2.0"	100%	50.000 mm	1.5"	100%	37.500 mm	1.25"	100%	31.500 mm	1.0"	100%	25.000 mm	3/4"	100%	19.000 mm	5/8"	100%	16.000 mm	1/2"	100%	12.500 mm	3/8"	100%	9.500 mm	1/4"	100%	6.300 mm	#4	100%	4.750 mm	#10	100%	2.000 mm	#20	99%	0.850 mm	#40	99%	0.425 mm	#100	55%	0.150 mm	#200	16.2%	0.075 mm	<b>Silts</b>	15.9%	0.074 mm		9.1%	0.050 mm		7.0%	0.020 mm	<b>Clays</b>	2.9%	0.005 mm		1.3%	0.002 mm	<b>Colloids</b>	0.7%	0.001 mm
Hydrometer Reading	Corrected Reading	Percent Passing	Soils Particle Diameter																																																																																																							
1	9	9.3%	0.0533 mm																																																																																																							
2	8	8.2%	0.0380 mm																																																																																																							
5	7	7.2%	0.0242 mm																																																																																																							
15	6.5	6.7%	0.0140 mm																																																																																																							
30	5.5	5.7%	0.0100 mm																																																																																																							
60	4	4.1%	0.0071 mm																																																																																																							
240	2	2.1%	0.0036 mm																																																																																																							
1440	1	1.0%	0.0015 mm																																																																																																							
Sieve Size	Percent Passing	Soils Particle Diameter																																																																																																								
3.0"	100%	75.000 mm																																																																																																								
2.0"	100%	50.000 mm																																																																																																								
1.5"	100%	37.500 mm																																																																																																								
1.25"	100%	31.500 mm																																																																																																								
1.0"	100%	25.000 mm																																																																																																								
3/4"	100%	19.000 mm																																																																																																								
5/8"	100%	16.000 mm																																																																																																								
1/2"	100%	12.500 mm																																																																																																								
3/8"	100%	9.500 mm																																																																																																								
1/4"	100%	6.300 mm																																																																																																								
#4	100%	4.750 mm																																																																																																								
#10	100%	2.000 mm																																																																																																								
#20	99%	0.850 mm																																																																																																								
#40	99%	0.425 mm																																																																																																								
#100	55%	0.150 mm																																																																																																								
#200	16.2%	0.075 mm																																																																																																								
<b>Silts</b>	15.9%	0.074 mm																																																																																																								
	9.1%	0.050 mm																																																																																																								
	7.0%	0.020 mm																																																																																																								
<b>Clays</b>	2.9%	0.005 mm																																																																																																								
	1.3%	0.002 mm																																																																																																								
<b>Colloids</b>	0.7%	0.001 mm																																																																																																								
<b>USDA Soil Textural Classification</b>																																																																																																										
<table style="width: 100%; border-collapse: collapse;"> <tr> <td style="width: 30%;"><b>% Sand:</b></td> <td>2.0 - 0.05 mm</td> </tr> <tr> <td><b>% Silt:</b></td> <td>0.05 - 0.002 mm</td> </tr> <tr> <td><b>% Clay:</b></td> <td>&lt; 0.002 mm</td> </tr> </table> <p style="text-align: center; margin-top: 10px;"> <b>USDA Soil Textural Classification</b>  Sand </p>	<b>% Sand:</b>	2.0 - 0.05 mm	<b>% Silt:</b>	0.05 - 0.002 mm	<b>% Clay:</b>	< 0.002 mm																																																																																																				
<b>% Sand:</b>	2.0 - 0.05 mm																																																																																																									
<b>% Silt:</b>	0.05 - 0.002 mm																																																																																																									
<b>% Clay:</b>	< 0.002 mm																																																																																																									

All results apply only to actual locations and materials tested. As a mutual protection to clients, the public and ourselves, all reports are submitted as the confidential property of clients, and authorization for publication of statements, conclusions or extracts from or regarding our reports is reserved pending our written approval.

**Comments:** \_\_\_\_\_  
\_\_\_\_\_  
\_\_\_\_\_

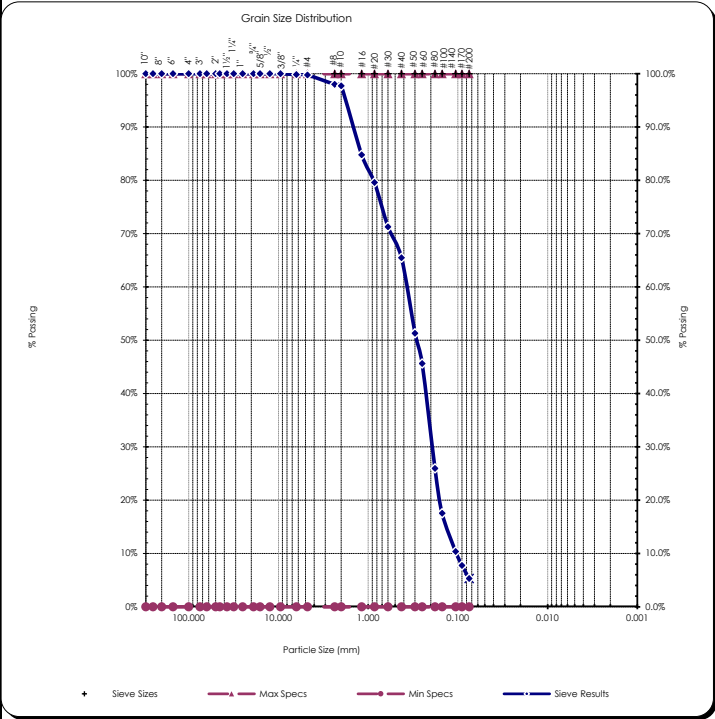
**Reviewed by:**   
\_\_\_\_\_ Meghan Blodgett-Carrillo

# Sieve Report

<b>Project:</b> Q.C. - Lower Duwamish Waterway <b>Project #:</b> 21B233 <b>Client:</b> Anchor QEA <b>Source:</b> LDW21-GT48-GB-15-18.2 ft <b>Sample#:</b> B21-2067	<b>Date Received:</b> 29-Jul-21 <b>Sampled By:</b> Client <b>Date Tested:</b> 8-Oct-21 <b>Tested By:</b> A. Eifrig	<b>Unified Soils Classification System, ASTM D-2487</b> SP-SM, Poorly graded Sand with Silt <b>Sample Color:</b> dark brown	 <b>ACCREDITED</b> Certificate #: 1366.01
--	---	--	---

<b>ASTM D2216, ASTM D2419, ASTM D4318, ASTM D5281</b>			
<b>Specifications</b> No Specs <b>Sample Meets Specs ?</b> N/A	D <sub>(5)</sub> = 0.070 mm D <sub>(10)</sub> = 0.104 mm D <sub>(15)</sub> = 0.134 mm D <sub>(30)</sub> = 0.194 mm D <sub>(50)</sub> = 0.288 mm D <sub>(60)</sub> = 0.377 mm D <sub>(90)</sub> = 1.510 mm Dust Ratio = 4/49	% Gravel = 0.2% % Sand = 94.4% % Silt & Clay = 5.3% Liquid Limit = n/a Plasticity Index = n/a Sand Equivalent = n/a Fracture %, 1 Face = n/a Fracture %, 2+ Faces = n/a	Coeff. of Curvature, C <sub>c</sub> = 0.97 Coeff. of Uniformity, C <sub>u</sub> = 3.64 Fineness Modulus = 1.77 Plastic Limit = n/a Moisture %, as sampled = 21.9% Req'd Sand Equivalent = Req'd Fracture %, 1 Face = Req'd Fracture %, 2+ Faces =

<b>ASTM C136, ASTM D6913, ASTM C117</b>					
<b>Sieve Size</b>		<b>Actual Cumulative Percent Passing</b>	<b>Interpolated Cumulative Percent Passing</b>	<b>Specs Max</b>	<b>Specs Min</b>
<b>US</b>	<b>Metric</b>				
12.00"	300.00		100%	100.0%	0.0%
10.00"	250.00		100%	100.0%	0.0%
8.00"	200.00		100%	100.0%	0.0%
6.00"	150.00		100%	100.0%	0.0%
4.00"	100.00		100%	100.0%	0.0%
3.00"	75.00		100%	100.0%	0.0%
2.50"	63.00		100%	100.0%	0.0%
2.00"	50.00	100%	100%	100.0%	0.0%
1.75"	45.00	100%	100%	100.0%	0.0%
1.50"	37.50	100%	100%	100.0%	0.0%
1.25"	31.50	100%	100%	100.0%	0.0%
1.00"	25.00	100%	100%	100.0%	0.0%
3/4"	19.00	100%	100%	100.0%	0.0%
5/8"	16.00	100%	100%	100.0%	0.0%
1/2"	12.50	100%	100%	100.0%	0.0%
3/8"	9.50	100%	100%	100.0%	0.0%
1/4"	6.30	100%	100%	100.0%	0.0%
#4	4.75	100%	100%	100.0%	0.0%
#8	2.36	100%	100%	100.0%	0.0%
#10	2.00	98%	98%	100.0%	0.0%
#16	1.18	85%	85%	100.0%	0.0%
#20	0.850	80%	80%	100.0%	0.0%
#30	0.600	71%	71%	100.0%	0.0%
#40	0.425	65%	65%	100.0%	0.0%
#50	0.300	51%	51%	100.0%	0.0%
#60	0.250	46%	46%	100.0%	0.0%
#80	0.180	26%	26%	100.0%	0.0%
#100	0.150	18%	18%	100.0%	0.0%
#140	0.106	10%	10%	100.0%	0.0%
#170	0.090	8%	8%	100.0%	0.0%
#200	0.075	5.3%	5.3%	100.0%	0.0%



Copyright Spears Engineering & Technical Services PS, 1996-98  
 All results apply only to actual locations and materials tested. As a mutual protection to clients, the public and ourselves, all reports are submitted as the confidential property of clients, and authorization for publication of statements, conclusions or extracts from or regarding our reports is reserved pending our written approval.

**Comments:** \_\_\_\_\_

Reviewed by:   
 Meghan Blodgett-Carrillo

# Sieve Report

<b>Project:</b> Q.C. - Lower Duwamish Waterway <b>Project #:</b> 21B233 <b>Client:</b> Anchor QEA <b>Source:</b> LDW21-GT48-GB-18.2-19.5 ft <b>Sample#:</b> B21-2068	<b>Date Received:</b> 29-Jul-21 <b>Sampled By:</b> Client <b>Date Tested:</b> 8-Oct-21 <b>Tested By:</b> A. Eifrig	<b>Visual Identification</b> Sandy Silt <b>Sample Color:</b> brown
--	---	---



**ASTM D2216, ASTM D2419, ASTM D4318, ASTM D5281**

**Specifications**

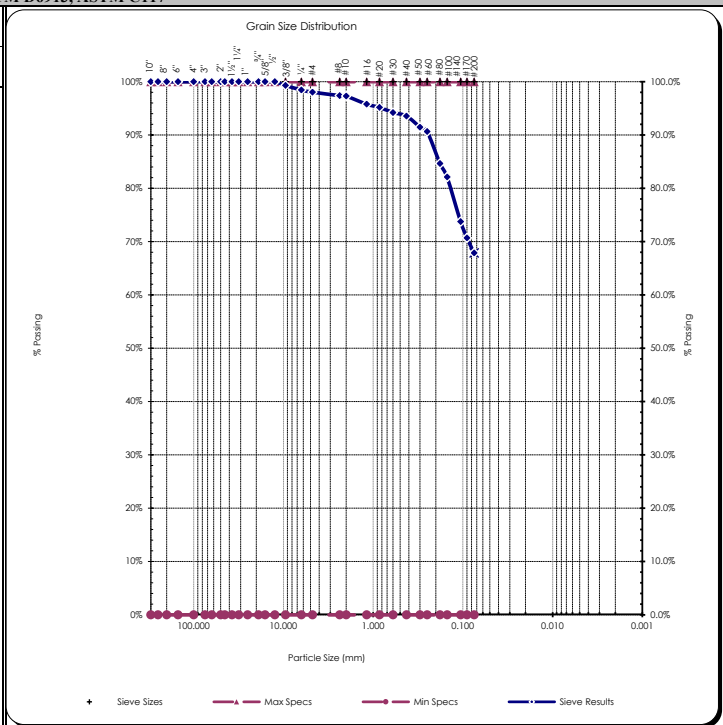
No Specs

Sample Meets Specs ? **N/A**

D <sub>(5)</sub> = 0.006 mm	% Gravel = 2.0%	Coeff. of Curvature, C <sub>c</sub> = 1.50
D <sub>(10)</sub> = 0.011 mm	% Sand = 30.2%	Coeff. of Uniformity, C <sub>u</sub> = 6.00
D <sub>(15)</sub> = 0.017 mm	% Silt & Clay = 67.9%	Fineness Modulus = 0.42
D <sub>(30)</sub> = 0.033 mm	Liquid Limit = n/a	Plastic Limit = n/a
D <sub>(50)</sub> = 0.055 mm	Plasticity Index = n/a	Moisture %, as sampled = 30.8%
D <sub>(60)</sub> = 0.066 mm	Sand Equivalent = n/a	Req'd Sand Equivalent =
D <sub>(90)</sub> = 0.242 mm	Fracture %, 1 Face = n/a	Req'd Fracture %, 1 Face =
Dust Ratio = 37/51	Fracture %, 2+ Faces = n/a	Req'd Fracture %, 2+ Faces =

**ASTM C136, ASTM D6913, ASTM C117**

Sieve Size		Actual Cumulative Percent Passing	Interpolated Cumulative Percent Passing	Specs Max	Specs Min
US	Metric				
12.00"	300.00		100%	100.0%	0.0%
10.00"	250.00		100%	100.0%	0.0%
8.00"	200.00		100%	100.0%	0.0%
6.00"	150.00		100%	100.0%	0.0%
4.00"	100.00		100%	100.0%	0.0%
3.00"	75.00		100%	100.0%	0.0%
2.50"	63.00		100%	100.0%	0.0%
2.00"	50.00	100%	100%	100.0%	0.0%
1.75"	45.00		100%	100.0%	0.0%
1.50"	37.50		100%	100.0%	0.0%
1.25"	31.50		100%	100.0%	0.0%
1.00"	25.00	100%	100%	100.0%	0.0%
3/4"	19.00	100%	100%	100.0%	0.0%
5/8"	16.00		100%	100.0%	0.0%
1/2"	12.50	100%	100%	100.0%	0.0%
3/8"	9.50	99%	99%	100.0%	0.0%
1/4"	6.30		98%	100.0%	0.0%
#4	4.75	98%	98%	100.0%	0.0%
#8	2.36		97%	100.0%	0.0%
#10	2.00	97%	97%	100.0%	0.0%
#16	1.18		96%	100.0%	0.0%
#20	0.850	95%	95%	100.0%	0.0%
#30	0.600		94%	100.0%	0.0%
#40	0.425	94%	94%	100.0%	0.0%
#50	0.300		91%	100.0%	0.0%
#60	0.250	91%	91%	100.0%	0.0%
#80	0.180		85%	100.0%	0.0%
#100	0.150	82%	82%	100.0%	0.0%
#140	0.106		74%	100.0%	0.0%
#170	0.090		71%	100.0%	0.0%
#200	0.075	67.9%	67.9%	100.0%	0.0%



Copyright Spears Engineering & Technical Services PS, 1996-98

All results apply only to actual locations and materials tested. As a mutual protection to clients, the public and ourselves, all reports are submitted as the confidential property of clients, and authorization for publication of statements, conclusions or extracts from or regarding our reports is reserved pending our written approval.

**Comments:**

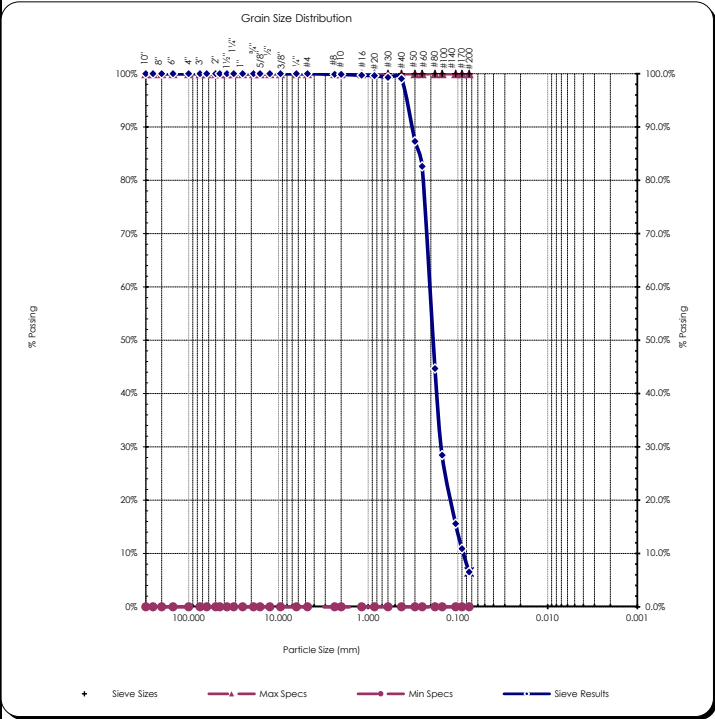
Reviewed by:   
 Meghan Blodgett-Carrillo

# Sieve Report

<b>Project:</b> Q.C. - Lower Duwamish Waterway <b>Project #:</b> 21B233 <b>Client:</b> Anchor QEA <b>Source:</b> LDW21-GT48-GB-20-21.6 ft <b>Sample#:</b> B21-2069	<b>Date Received:</b> 29-Jul-21 <b>Sampled By:</b> Client <b>Date Tested:</b> 8-Oct-21 <b>Tested By:</b> A. Eifrig	<b>Unified Soils Classification System, ASTM D-2487</b> SP-SM, Poorly graded Sand with Silt <b>Sample Color:</b> dark brown	 <b>ACCREDITED</b> Certificate #: 1366.01
--	---	--	---

<b>ASTM D2216, ASTM D2419, ASTM D4318, ASTM D5281</b>			
<b>Specifications</b> No Specs <b>Sample Meets Specs ?</b> N/A	D <sub>(5)</sub> = 0.057 mm D <sub>(10)</sub> = 0.087 mm D <sub>(15)</sub> = 0.104 mm D <sub>(30)</sub> = 0.153 mm D <sub>(50)</sub> = 0.190 mm D <sub>(60)</sub> = 0.208 mm D <sub>(90)</sub> = 0.329 mm Dust Ratio = 6/91	% Gravel = 0.0% % Sand = 93.5% % Silt & Clay = 6.5% Liquid Limit = n/a Plasticity Index = n/a Sand Equivalent = n/a Fracture %, 1 Face = n/a Fracture %, 2+ Faces = n/a	Coeff. of Curvature, C <sub>c</sub> = 1.29 Coeff. of Uniformity, C <sub>u</sub> = 2.40 Fineness Modulus = 0.85 Plastic Limit = n/a Moisture %, as sampled = 31.2% Req'd Sand Equivalent = Req'd Fracture %, 1 Face = Req'd Fracture %, 2+ Faces =

<b>ASTM C136, ASTM D6913, ASTM C117</b>					
<b>Sieve Size</b>		<b>Actual Cumulative Percent Passing</b>	<b>Interpolated Cumulative Percent Passing</b>	<b>Specs Max</b>	<b>Specs Min</b>
<b>US</b>	<b>Metric</b>				
12.00"	300.00		100%	100.0%	0.0%
10.00"	250.00		100%	100.0%	0.0%
8.00"	200.00		100%	100.0%	0.0%
6.00"	150.00		100%	100.0%	0.0%
4.00"	100.00		100%	100.0%	0.0%
3.00"	75.00		100%	100.0%	0.0%
2.50"	63.00		100%	100.0%	0.0%
2.00"	50.00	100%	100%	100.0%	0.0%
1.75"	45.00	100%	100%	100.0%	0.0%
1.50"	37.50	100%	100%	100.0%	0.0%
1.25"	31.50	100%	100%	100.0%	0.0%
1.00"	25.00	100%	100%	100.0%	0.0%
3/4"	19.00	100%	100%	100.0%	0.0%
5/8"	16.00	100%	100%	100.0%	0.0%
1/2"	12.50	100%	100%	100.0%	0.0%
3/8"	9.50	100%	100%	100.0%	0.0%
1/4"	6.30	100%	100%	100.0%	0.0%
#4	4.75	100%	100%	100.0%	0.0%
#8	2.36	100%	100%	100.0%	0.0%
#10	2.00	100%	100%	100.0%	0.0%
#16	1.18	100%	100%	100.0%	0.0%
#20	0.850	100%	100%	100.0%	0.0%
#30	0.600		99%	100.0%	0.0%
#40	0.425	99%	99%	100.0%	0.0%
#50	0.300		87%	100.0%	0.0%
#60	0.250	83%	83%	100.0%	0.0%
#80	0.180		45%	100.0%	0.0%
#100	0.150	28%	28%	100.0%	0.0%
#140	0.106		16%	100.0%	0.0%
#170	0.090		11%	100.0%	0.0%
#200	0.075	6.5%	6.5%	100.0%	0.0%



Copyright Spears Engineering & Technical Services PS, 1996-98  
 All results apply only to actual locations and materials tested. As a mutual protection to clients, the public and ourselves, all reports are submitted as the confidential property of clients, and authorization for publication of statements, conclusions or extracts from or regarding our reports is reserved pending our written approval.

**Comments:** \_\_\_\_\_

Reviewed by:   
 Meghan Blodgett-Carrillo





October 19, 2021  
HWA Project No. 2012-002-23 Task 51

**Materials Testing & Consulting, Inc.**

777 Chrysler Drive  
Burlington, WA 98233

Attention: Ms. Meghan Blodgett-Carrillo

Subject: **LABORATORY TESTING REPORT**  
**QC - Lower Duwamish Waterway**  
**MTC Project Number: 21B233**

Dear Ms. Blodgett-Carrillo;

In accordance with your request, HWA GeoSciences Inc. (HWA) performed laboratory testing for the above referenced project. Herein we present the results of our laboratory analyses, which are summarized on the attached Figures. The laboratory testing program was performed in general accordance with your instructions and appropriate ASTM Standards as outlined below.

**SAMPLE DESCRIPTION:** The subject samples were delivered to our laboratory on August 26, 2021 by MTC personnel. The samples were delivered in four Shelby tubes and were designated with exploration ID and depth of sampling. The soil samples were classified using visual-manual methods. The descriptions may be found on the attached Summary of Material Properties, Figure 1.

**MOISTURE CONTENT OF SOIL:** The moisture contents of the soil samples (percent by dry mass) were determined in general accordance with ASTM D2216. The results are shown on Figure 1.

**SPECIFIC GRAVITY OF SOILS:** The specific gravity of the selected samples was determined using method ASTM D854. The test results are shown on the attached Summary of Material Properties, Figure 1.

**LIQUID LIMIT, PLASTIC LIMIT, AND PLASTICITY INDEX OF SOILS (ATTERBERG LIMITS):** The plasticity index of each specified sample was tested using method ASTM D4318, multi-point method. The results are reported on the attached Liquid Limit, Plastic Limit, and Plasticity Index of Soils Report, Figure 2.

**CONSOLIDATED UNDRAINED TRIAXIAL COMPRESSION OF SOILS:** Selected samples were tested in general accordance with method ASTM D4767 to determine the shear strength characteristics of the soil. The samples were extruded from Shelby tubes, and the test specimens were trimmed to obtain a cylindrical test sample with a length to diameter ratio between 2:1 and 2.5:1. The specimens were carefully weighed and measured prior to testing.

Three trials were run at varying confining stresses specified by the client. Each sample was run using a single specimen to perform a multi-stage shear test.

The multi-stage method was performed by first consolidating the sample at the lowest specified confining pressure. The sample was then sheared until the change in pore pressure was at or near its estimated peak. After reaching the peak change in pore pressure, the shear phase was terminated, and the specimen was reconsolidated at the middle consolidation pressure. Under the second consolidation pressure the sample was again sheared until the change in pore pressure was at or near its estimated peak, at which point the shear was terminated. The sample was reconsolidated a third and final time under the highest confining pressure and shearing was performed to sample failure, concluding the test.

For sample LDW21-GT33-GB at 6.0-8.0', the test was terminated at 20.5% strain due to a spike in pore pressure caused by a perforation in the membrane encasing the sample. As a result, the final moisture content of the sample was affected due to the ingress of water from the surrounding water filled pressure cell. The final moisture content for this sample was determined to be 70.7%.

The Consolidated Undrained test results are summarized and plotted graphically in Figures 3-6.

**ONE DIMENSIONAL CONSOLIDATION PROPERTIES OF SOIL:** The consolidation properties of selected soil samples were measured in general accordance with ASTM D 2435. Saturation was maintained by inundation of the sample throughout the test. The samples were subjected to increasing increments of total stress, the duration of which was selected to exceed the time required for completion of primary consolidation as defined in the Standard, Method B. Unloading of the sample was carried out incrementally. The primary compression test results are presented on the attached Consolidation Test Reports, Figures 7-10.



**CLOSURE:** Experience has shown that test values on soil and other natural materials vary with each representative sample. As such, HWA has no knowledge as to the extent and quantity of material the tested samples may represent. HWA also makes no warranty as to how representative either the samples tested or the test results obtained are to actual field conditions. It is a well-established fact that sampling methods present varying degrees of disturbance that affect sample representativeness.

No copy should be made of this report except in its entirety.

We appreciate the opportunity to provide laboratory testing services on this project. Should you have any questions or comments, or if we may be of further service, please call.

Sincerely,

**HWA GEOSCIENCES INC.**

Greg Barker  
Materials Laboratory Supervisor

Steven E. Greene, L.G., L.E.G.  
Principal Engineering Geologist  
Vice President

Attachments:

Figure 1  
Figure 2  
Figures 3-6  
Figures 7-10

Summary of Material Properties  
Liquid Limit, Plastic Limit and Plasticity Index of Soils  
Consolidated Undrained Triaxial Compression Test for Cohesive Soils  
Consolidation Test Report

EXPLORATION DESIGNATION	TOP DEPTH (feet)	BOTTOM DEPTH (feet)	MOISTURE CONTENT (%)	ORGANIC CONTENT (%)	SPECIFIC GRAVITY	ATTERBERG LIMITS (%)			% GRAVEL	% SAND	% FINES	ASTM SOIL CLASSIFICATION	SAMPLE DESCRIPTION
						LL	PL	PI					
LDW21-GT23-GB,	28.5	30.5	33.3		2.617	26	25	1				SM	Dark grayish-brown, silty SAND
LDW21-GT33-GB,	6.0	8.0	58.6		2.612	38	36	2				ML	Very dark grayish-brown, SILT with sand
LDW21-GT33-GB,	21.0	23.0	35.3		2.643	31	29	2				SM	Very dark grayish-brown, silty SAND
LDW21-GT53-SPT,	30.0	32.0	43.6		2.627	38	27	11				ML	Very dark grayish-brown, SILT with sand

Notes: 1. This table summarizes information presented elsewhere in the report and should be used in conjunction with the report test, other graphs and tables, and the exploration logs.  
2. The soil classifications in this table are based on ASTM D2487 and D2488 as applicable.

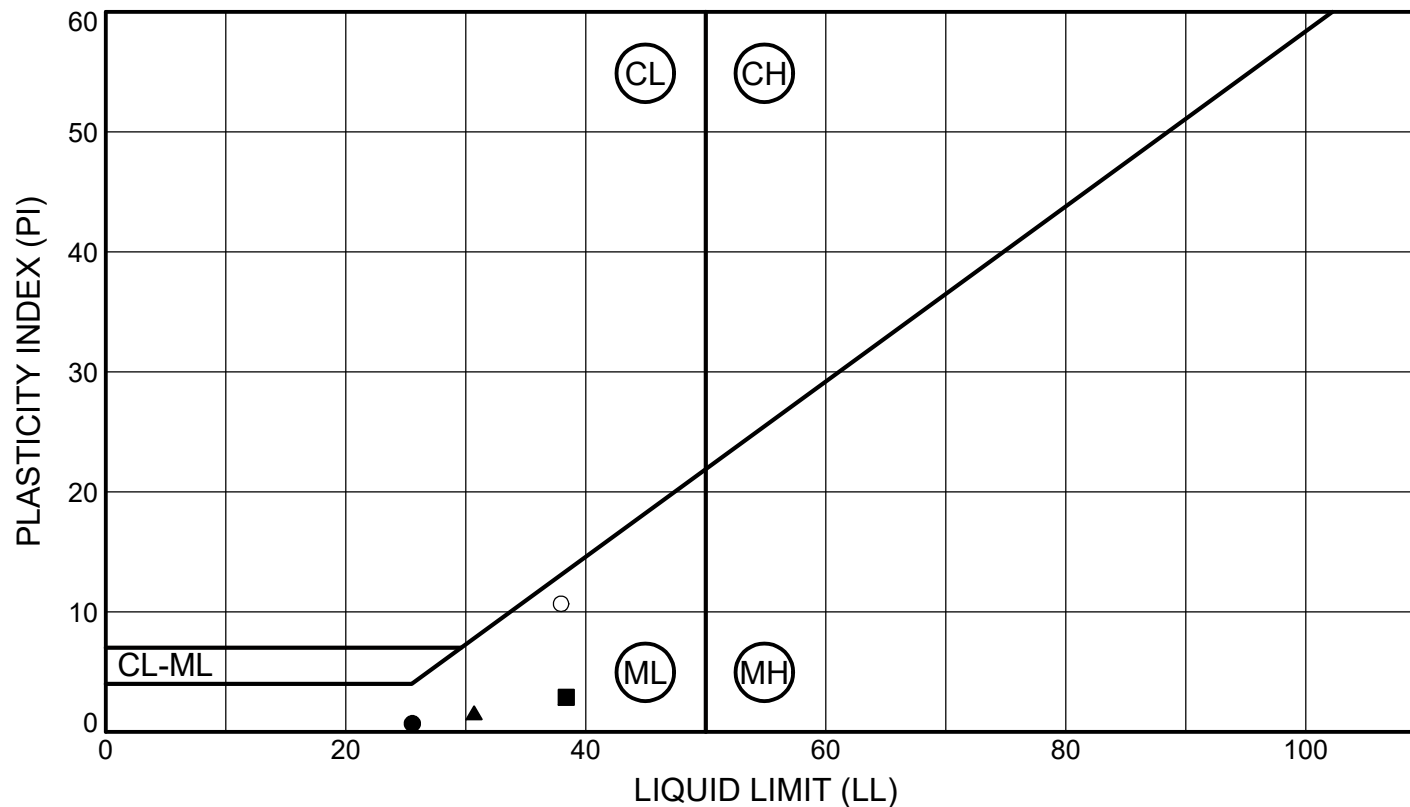


MLT for MTC, Inc.  
QC - Lower Duwamish Waterway  
Client Project No.: 21B233

SUMMARY OF MATERIAL PROPERTIES

PAGE: 1 of 1

PROJECT NO.: 2012-002 T51 FIGURE: 1



SYMBOL	SAMPLE	DEPTH (ft)	CLASSIFICATION	% MC	LL	PL	PI	% Fines
●	LDW21-GT23-GB	28.5 - 30.5	(SM) Dark grayish-brown, silty SAND	33	26	25	1	
■	LDW21-GT33-GB	6.0 - 8.0	(ML) Very dark grayish-brown, SILT with sand	59	38	36	2	
▲	LDW21-GT33-GB	21.0 - 23.0	(SM) Very dark grayish-brown, silty SAND	35	31	29	2	
○	LDW21-GT53-SPT	30.0 - 32.0	(ML) Very dark grayish-brown, SILT with sand	44	38	27	11	



MLT for MTC, Inc.  
 QC - Lower Duwamish Waterway  
 Client Project No.: 21B233

LIQUID LIMIT, PLASTIC LIMIT AND  
 PLASTICITY INDEX OF SOILS  
 METHOD ASTM D4318

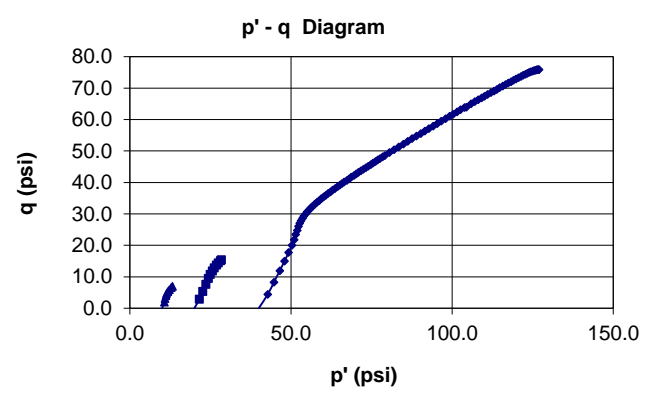
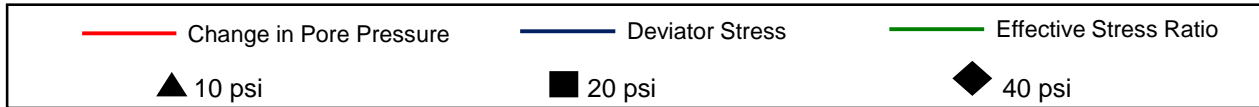
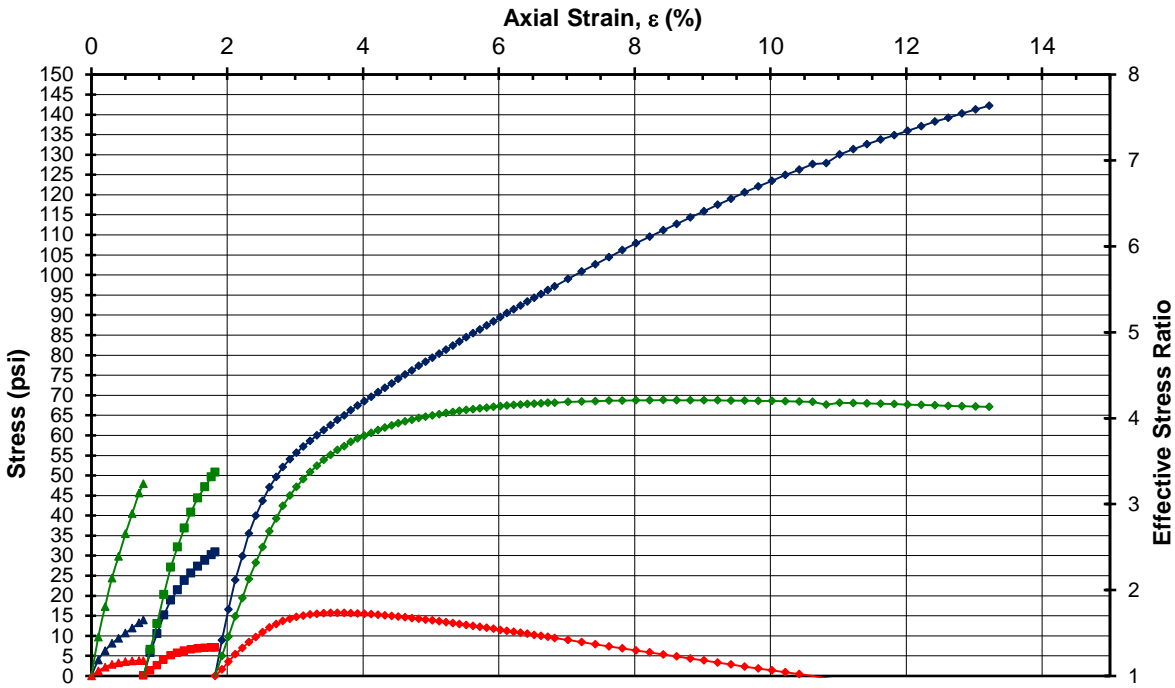
PROJECT NO.: 2012-002 T51 FIGURE: 2

**HWA GeoSciences Inc - Materials Testing Laboratory**

**Consolidated-Undrained Triaxial Compression Test for Cohesive Soils (ASTM D 4767)**

Project Name:	Lower Duwamish Waterway		Date:	8/27/2021			
Project No.:	2012-002-23 T51	Exploration ID:	LDW21-GT23-GB				
Technician:	DW	Sample No.:	n/a				
Sample Description:	Dark grayish-brown, silty SAND (SM)		Sample Depth, ft:	28.5-30.5'			
Confining Pressures:	<b>10 psi</b>	<b>20 psi</b>	<b>40 psi</b>	Consolidation T50 Values (minutes)			
Initial Moisture:	33.4%	Final Moisture:	32.4%	10 psi	20 psi	40 psi	
Initial Wet Density, pcf:	115.2				0.6	0.6	1.0
Initial Dry Density, pcf:	86.3						

**Deviator Stress, Excess Pore Pressure and Effective Stress Ratio**

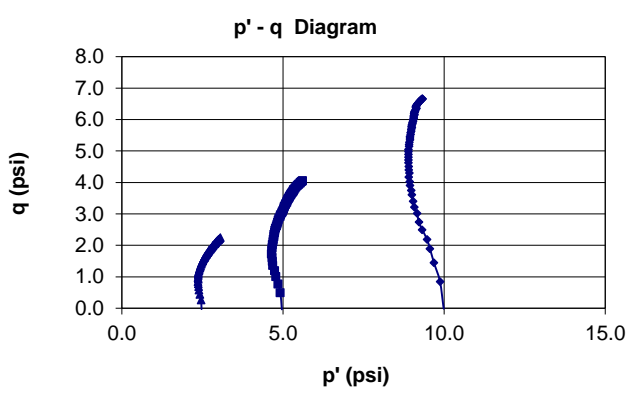
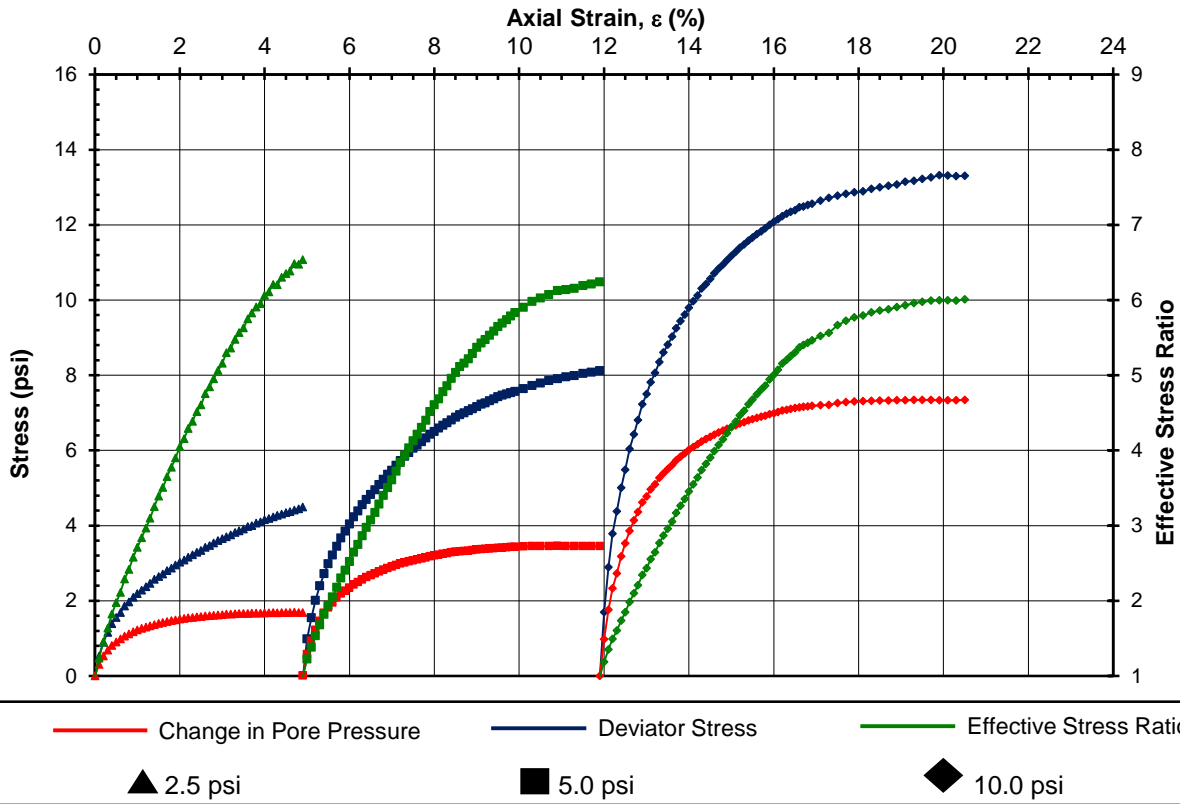


**HWA GeoSciences Inc - Materials Testing Laboratory**

**Consolidated-Undrained Triaxial Compression Test for Cohesive Soils (ASTM D 4767)**

Project Name:	Lower Duwamish Waterway		Date:	8/28/2021		
Project No.:	2012-002-23 T51	Exploration ID:	LDW21-GT33-GB			
Technician:	GB	Sample No:	n/a			
Sample Description:	Very dark grayish-brown, SILT with sand (ML)		Sample Depth, ft:	6.0 - 8.0		
Confining Pressures:	<b>2.5 psi</b>	<b>5.0 psi</b>	<b>10.0 psi</b>	Consolidation T50 Values (minutes)		
Initial Moisture:	64.8%	Final Moisture:	see report	2.5 psi	5.0 psi	10.0 psi
Initial Wet Density, pcf:	93.4			91.13	83.21	162.0
Initial Dry Density, pcf:	56.7					

**Deviator Stress, Excess Pore Pressure and Effective Stress Ratio**



Reviewed by: \_\_\_\_\_ SEG \_\_\_\_\_

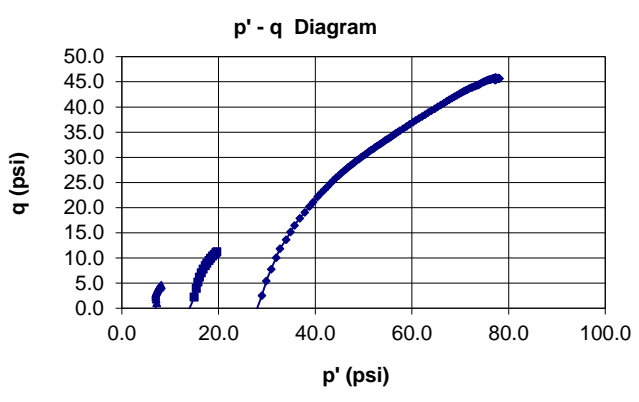
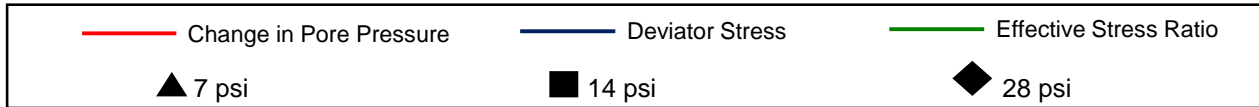
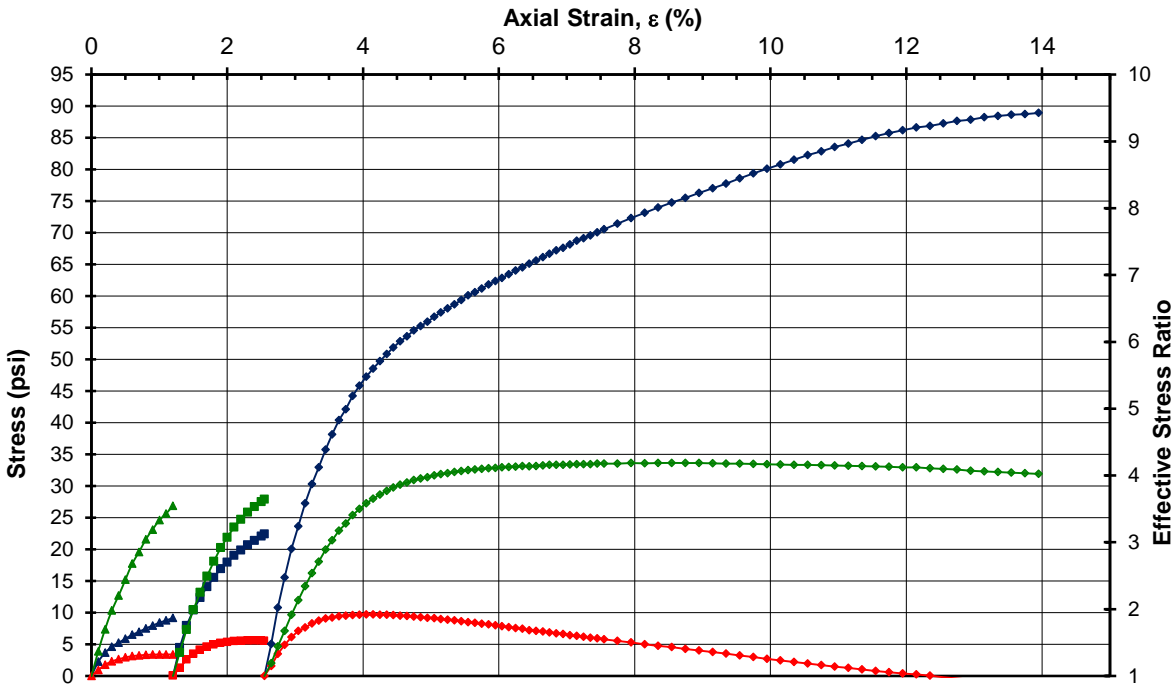
Figure \_\_\_\_\_ 4 \_\_\_\_\_

**HWA GeoSciences Inc - Materials Testing Laboratory**

**Consolidated-Undrained Triaxial Compression Test for Cohesive Soils (ASTM D 4767)**

Project Name:	Lower Duwamish Waterway		Date:	9/7/2021		
Project No.:	2012-002-23 T51	Exploration ID:	LDW21-GT33-GB			
Technician:	GB		Sample No:	n/a		
Sample Description:	Very dark grayish-brown, silty SAND (SM)		Sample Depth, ft:	21.0-23.0		
Confining Pressures:	<b>7 psi</b>	<b>14 psi</b>	<b>28 psi</b>	Consolidation T50 Values (minutes)		
Initial Moisture:	35.3%	Final Moisture:	34.7%	7 psi	14 psi	28 psi
Initial Wet Density, pcf:	109.6			144.5	23.8	0.3
Initial Dry Density, pcf:	81.0					

**Deviator Stress, Excess Pore Pressure and Effective Stress Ratio**



Reviewed by: \_\_\_\_\_ SEG

Figure \_\_\_\_\_ 5

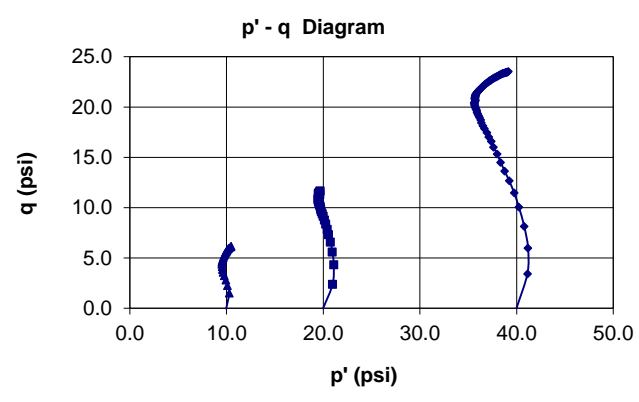
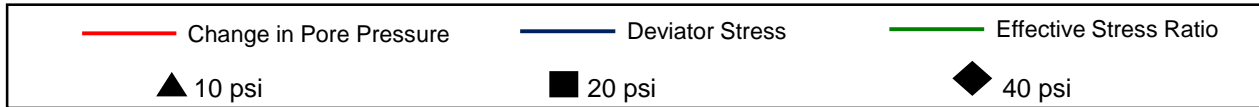
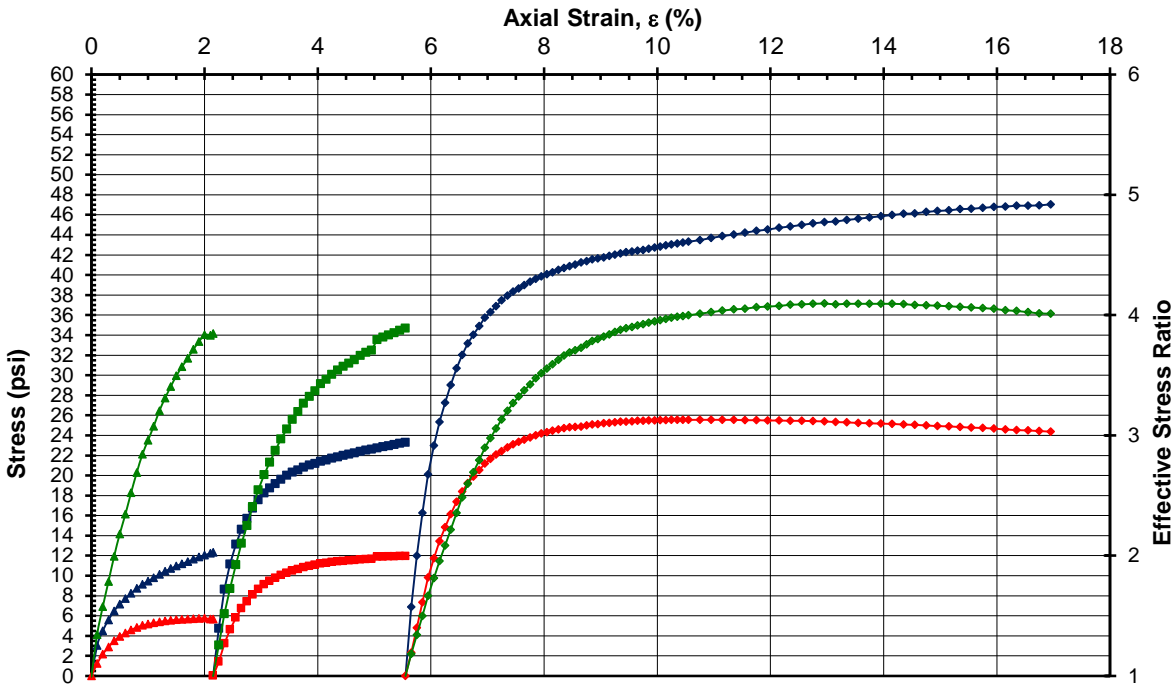


**HWA GeoSciences Inc - Materials Testing Laboratory**

**Consolidated-Undrained Triaxial Compression Test for Cohesive Soils (ASTM D 4767)**

Project Name:	Lower Duwamish Waterway		Date:	9/16/2021		
Project No.:	2012-002-23 T51	Exploration ID:	LDW21-GT53-SPT			
Technician:	GB		Sample No:	n/a		
Sample Description:	Very dark grayish-brown, SILT with sand (ML)		Sample Depth, ft:	30.0-32.0		
Confining Pressures:	<b>10 psi</b>	<b>20 psi</b>	<b>40 psi</b>	Consolidation T50 Values (minutes)		
Initial Moisture:	43.6%	Final Moisture:	36.3%	10 psi	20 psi	40 psi
Initial Wet Density, pcf:	112.3			10.13	5.5	15.3
Initial Dry Density, pcf:	78.2					

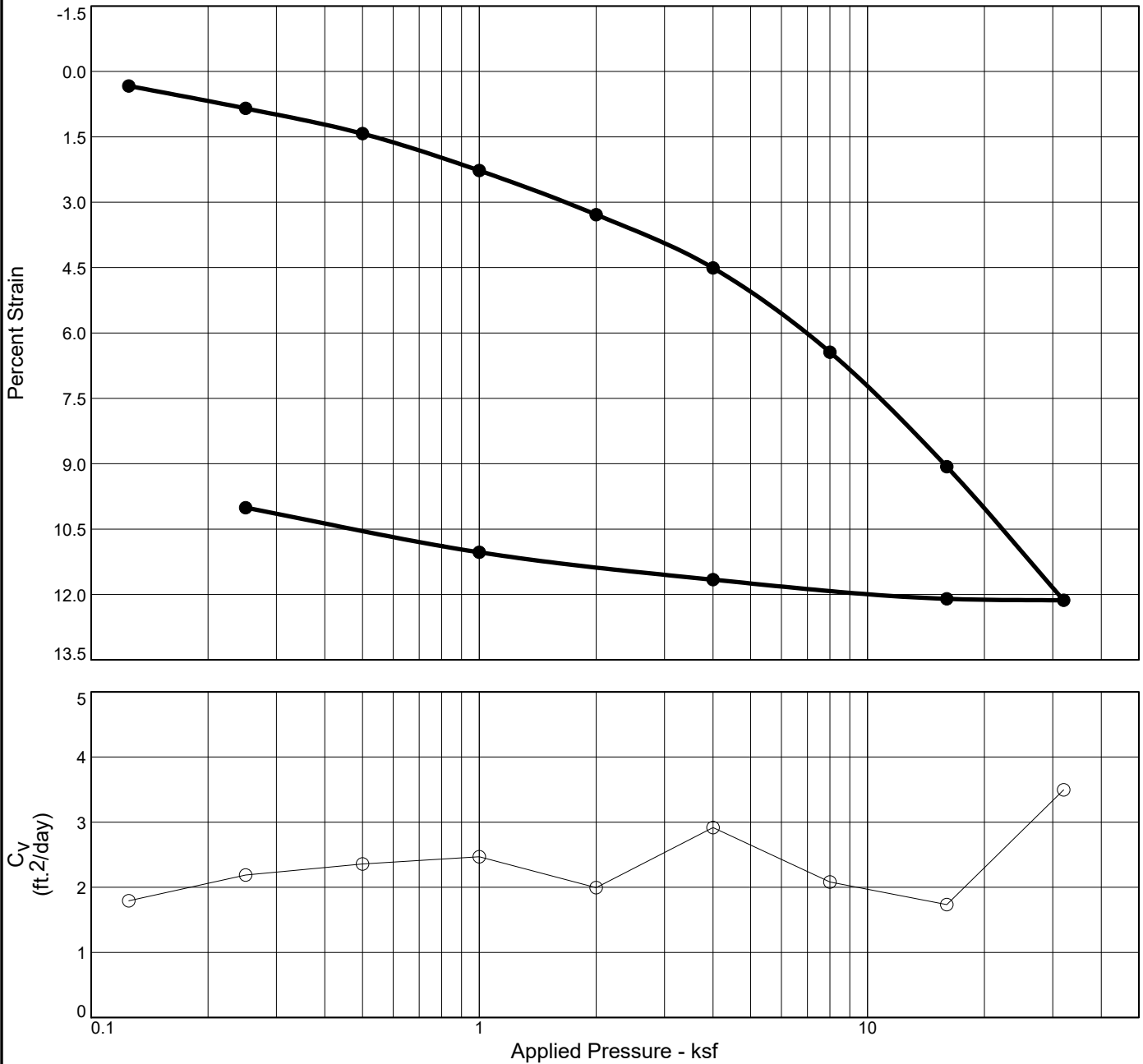
**Deviator Stress, Excess Pore Pressure and Effective Stress Ratio**



Reviewed by: \_\_\_\_\_ SEG \_\_\_\_\_

Figure \_\_\_\_\_ 6 \_\_\_\_\_

# CONSOLIDATION TEST REPORT



Natural								
Saturation	Moisture	Dry Dens. (pcf)	LL	PI	Sp. Gr.	USCS	AASHTO	Initial Void Ratio
89.4 %	33.3 %	82.8	26	1	2.617	SM		0.973

### MATERIAL DESCRIPTION

Dark grayish-brown, Silty SAND

**Project No.** 2012-002      **Client:** MTC  
**Project:** MLT for MTC  
 Lower Duwamish River  
**Source of Sample:** LDW21-GT23-GB      **Depth:** 28.5

**Remarks:**  
 Specific Gravity determined per ASTM D854

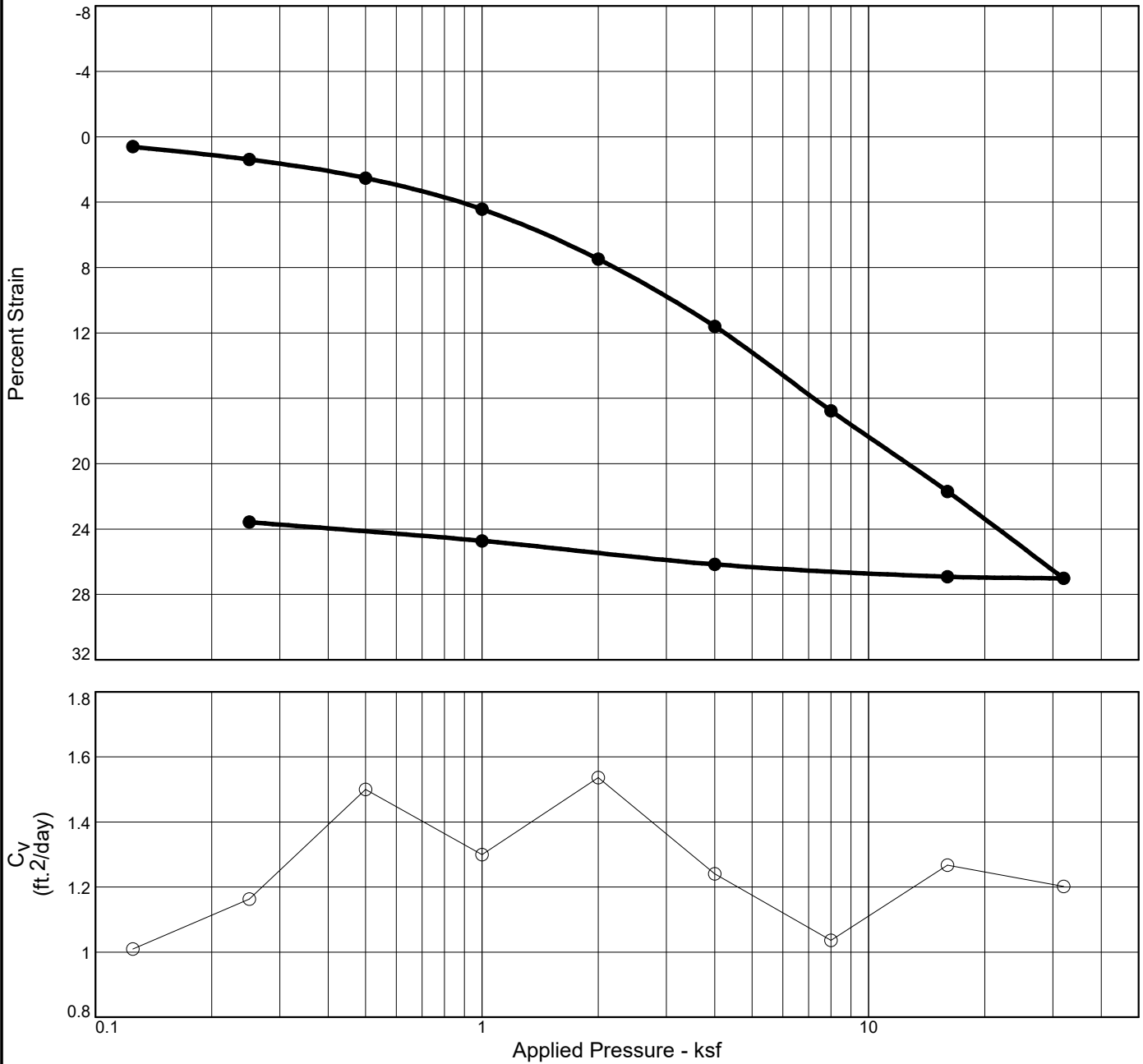


**Figure 7**

**Tested By:** AH/GB

**Checked By:** SEG

# CONSOLIDATION TEST REPORT



Natural		Dry Dens. (pcf)	LL	PI	Sp. Gr.	USCS	AASHTO	Initial Void Ratio
Saturation								
97.9 %	58.6 %	64.3	38	2	2.612	ML		1.564

### MATERIAL DESCRIPTION

Very dark grayish-brown, SILT with sand

**Project No.** 2012-002      **Client:** MTC

**Project:** MLT for MTC  
Lower Duwamish River

**Source of Sample:** LDW21-GT33-GB      **Depth:** 6.0

**Remarks:**

Specific Gravity determined per ASTM D854



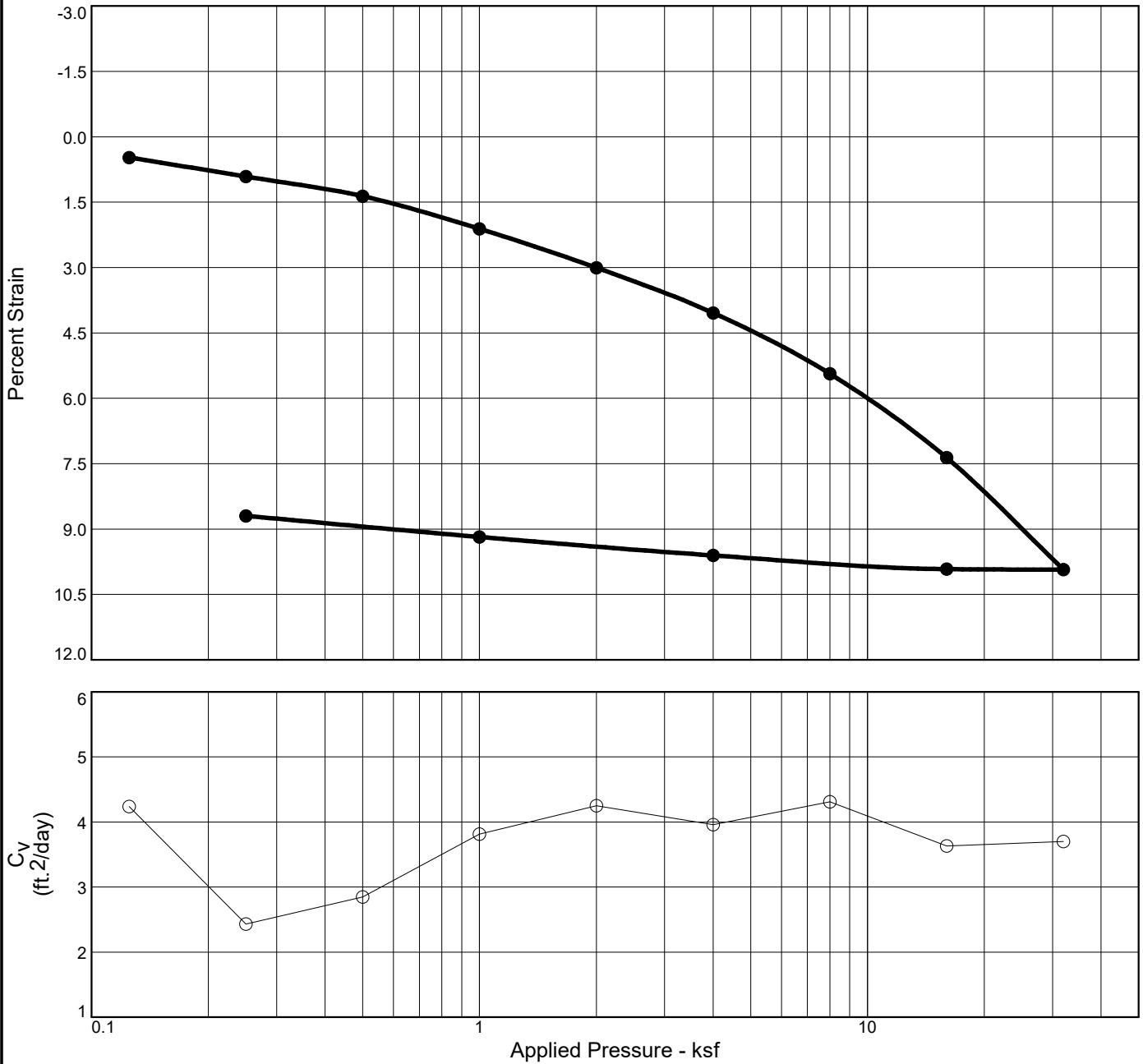
GEOSCIENCES INC.

DBE/MWBE

**Figure 8**

**Tested By:** GB

# CONSOLIDATION TEST REPORT



Natural		Dry Dens. (pcf)	LL	PI	Sp. Gr.	USCS	AASHTO	Initial Void Ratio
Saturation								
96.4 %	35.3 %	87.0	31	2	2.643	SM		0.968

### MATERIAL DESCRIPTION

Very dark grayish-brown, silty SAND

**Project No.** 2012-002      **Client:** MTC

**Project:** MLT for MTC  
Lower Duwamish River

**Source of Sample:** LDW21-GT33-GB      **Depth:** 21.0

**Remarks:**

Specific Gravity determined per ASTM D854



GEOSCIENCES INC.

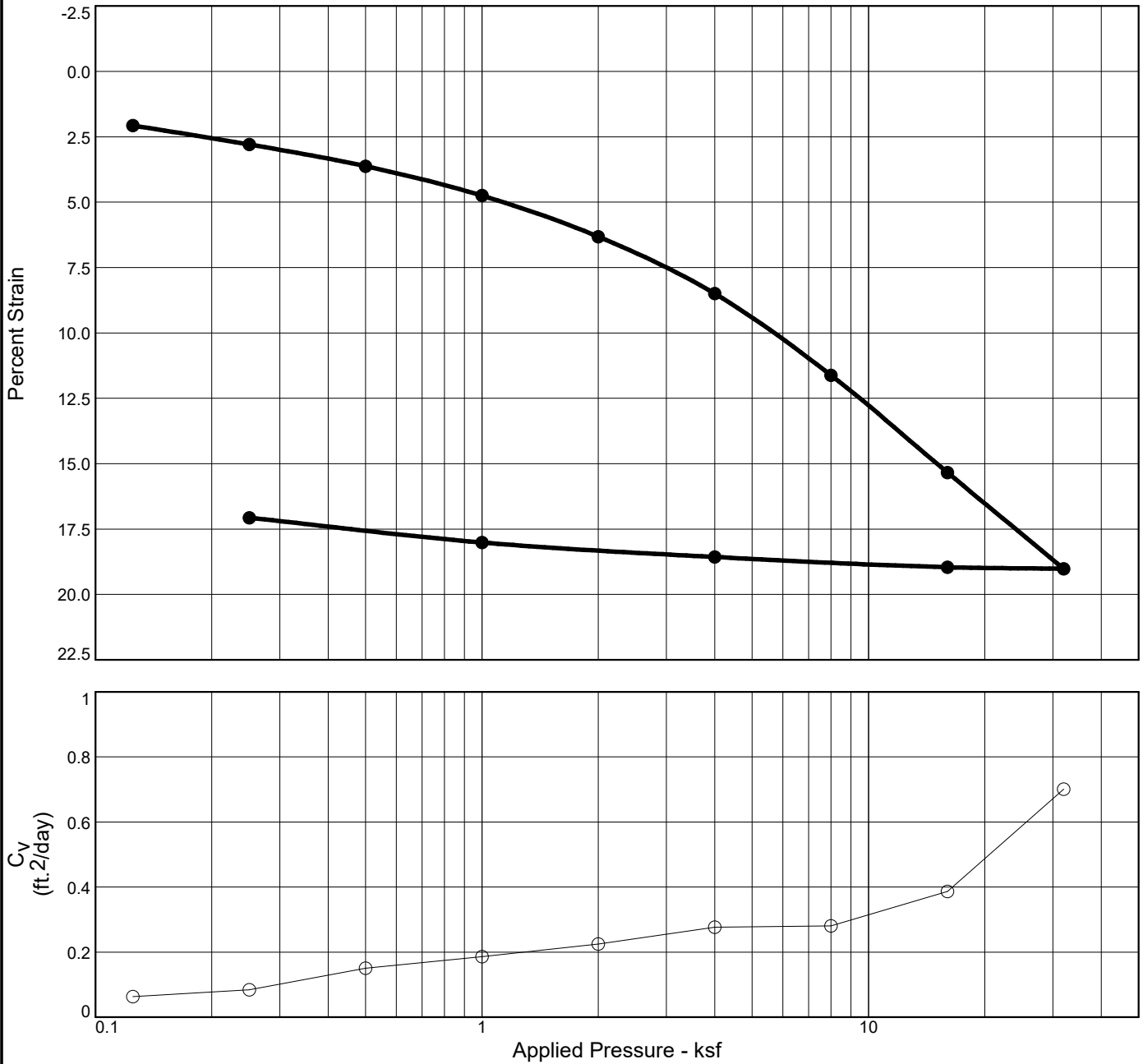
DBE/MWBE

Figure 9

Tested By: GB

Checked By: SEG

# CONSOLIDATION TEST REPORT



Natural		Dry Dens. (pcf)	LL	PI	Sp. Gr.	USCS	AASHTO	Initial Void Ratio
Saturation								
108.4 %	43.6 %	82.0	38	11	2.627	ML		1.058

### MATERIAL DESCRIPTION

Very dark grayish-brown, SILT with sand

**Project No.** 2012-002      **Client:** MTC

**Project:** MLT for MTC  
Lower Duwamish River

**Source of Sample:** LDW21-GT53-SPT      **Depth:** 30.0

**Remarks:**

Specific Gravity determined per ASTM D854



GEOSCIENCES INC.

DBE/MWBE

Figure 10

Tested By: GB

Checked By: SEG



**Client:** Anchor QEA  
**Address:** 21328 2nd Drive SE  
Bothell, WA 98021  
**Attn:** Garrett Timm  
**Revised on:** \_\_\_\_\_

**Date:** October 22, 2021  
**Project:** Q.C. - Lower Duwamish Waterway  
**Project #:** 21B233  
**Sample #:** B21-2006 - 2020  
**Date sampled:** 7-19-21 & 7-20-21

As requested MTC, Inc. has performed the following test(s) on the sample referenced above. The testing was performed in accordance with current applicable AASHTO or ASTM standards as indicated below. The results obtained in our laboratory were as follows below or on the attached pages:

	Test(s) Performed:	Test Results		Test(s) Performed:	Test Results
X	Sieve Analysis	Please See Attached Reports		Sulfate Soundness	
	Proctor			Bulk Density & Voids	
	Sand Equivalent			WSDOT Degradation	
	Fracture Count			LA Abrasion	
X	Moisture Content	Please See Attached Report	X	Direct Shear	Please See Attached Reports
	Specific Gravity, Coarse		X	Specific Gravity, Soils	Please See Attached Reports
	Specific Gravity, Fine				
X	Hydrometer Analysis	Please See Attached Reports			
X	Atterberg Limits	Please See Attached Reports			

If you have any questions concerning the test results, the procedures used, or if we can be of any further assistance please call on us at the number below.

Respectfully Submitted,  
 Meghan Blodgett-Carrillo  
 WABO Supervising Laboratory Technician






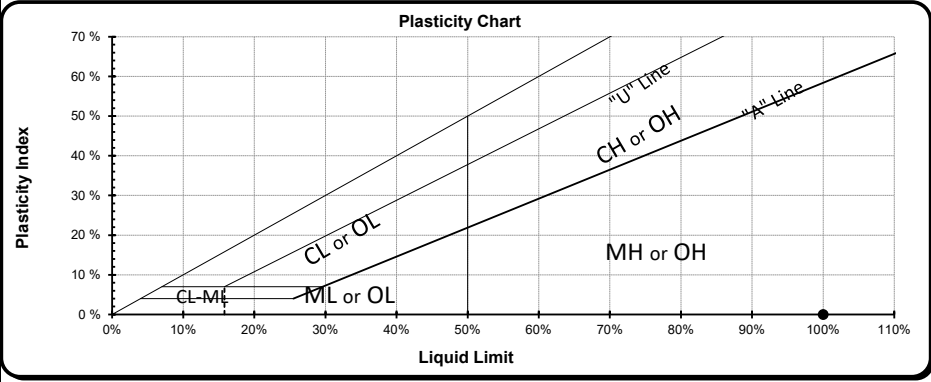
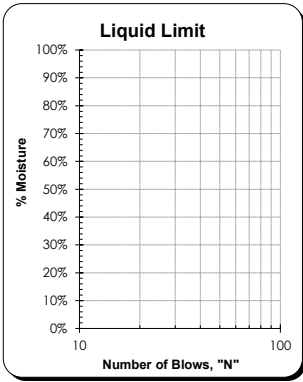


# Materials Testing & Consulting, Inc.

Geotechnical Engineering • Special Inspections • Materials Testing • Environmental Consulting



## ASTM D4318 - Liquid Limit, Plastic Limit and Plasticity Index of Soils

<b>Project:</b> Q.C. - Lower Duwamish Waterway <b>Project #:</b> 21B233 <b>Client:</b> Anchor QEA <b>Source:</b> LDW21-GT5-GB-0-7.5 ft <b>Sample #:</b> B21-2007	<b>Date Received:</b> 29-Jul-21 <b>Sampled By:</b> Client <b>Date Tested:</b> 14-Oct-21 <b>Tested By:</b> A. Eifrig	<b>Visual Identification</b> Sand with Silt <b>Sample Color</b> brown
<b>Liquid Limit Determination</b>		
Weight of Wet Soils + Pan: Weight of Dry Soils + Pan: Weight of Pan: Weight of Dry Soils: Weight of Moisture: % Moisture: Number of Blows:	#1 #2 #3 #4 #5 #6 Liquid limit cannot be established	Liquid Limit @ 25 Blows: N/A Plastic Limit: N/A Plasticity Index, I <sub>p</sub> : N/A
<b>Plastic Limit Determination</b>		
Weight of Wet Soils + Pan: Weight of Dry Soils + Pan: Weight of Pan: Weight of Dry Soils: Weight of Moisture: % Moisture:	#1 #2 #3 #4 #5 #6 Plastic limit cannot be determined	 ACCREDITED Certificate #: 1366.01, 1366.02 & 1366.04
		

Copyright Spears Engineering & Technical Services PS, 1996-98  
 All results apply only to actual locations and materials tested. As a mutual protection to clients, the public and ourselves, all reports are submitted as the confidential property of clients, and authorization for publication of statements, conclusions or extracts from or regarding our reports is reserved pending our written approval.

**Comments:** Liquid limit cannot be established as the material displays rapid dilation upon spreading into the cup. At lower moistures the material does not spread into the liquid limit device without tearing the soil cake. Plastic limit cannot be determined as the material does not roll down to 1/8" threads before cracking or crumbling. Non-plastic.

Reviewed by:   
 Meghan Blodgett-Carrillo



# Sieve Report

<b>Project:</b> Q.C. - Lower Duwamish Waterway <b>Project #:</b> 21B233 <b>Client:</b> Anchor QEA <b>Source:</b> LDW21-GT5-GB-7.5-17.2 ft <b>Sample#:</b> B21-2009	<b>Date Received:</b> 29-Jul-21 <b>Sampled By:</b> Client <b>Date Tested:</b> 6-Oct-21 <b>Tested By:</b> K. Mendez	<b>Unified Soil Classification System, ASTM-2487</b> SW-SM, Well-graded Sand with Silt and Gravel <b>Sample Color:</b> brown	 Certificate #: 1366.01
--	---	---	----------------------------

ASTM D2216, ASTM D2419, ASTM D4318, ASTM D5281

**Specifications**

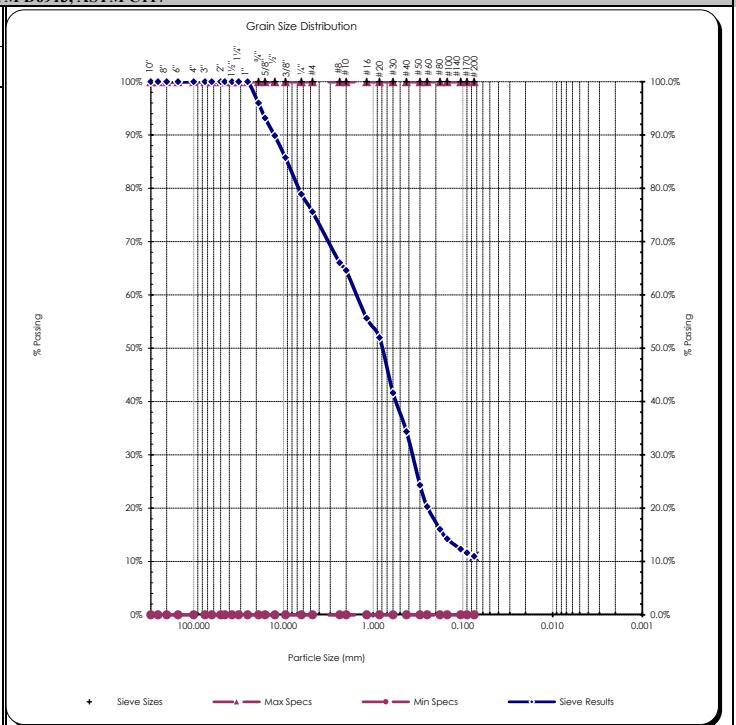
No Specs

Sample Meets Specs ? **N/A**

D <sub>(5)</sub> = 0.034 mm	% Gravel = 24.4%	Coeff. of Curvature, C <sub>c</sub> = 1.27
D <sub>(10)</sub> = 0.068 mm	% Sand = 64.6%	Coeff. of Uniformity, C <sub>u</sub> = 23.13
D <sub>(15)</sub> = 0.162 mm	% Silt & Clay = 11.0%	Fineness Modulus = 3.41
D <sub>(30)</sub> = 0.370 mm	Liquid Limit = n/a	Plastic Limit = n/a
D <sub>(50)</sub> = 0.801 mm	Plasticity Index = n/a	Moisture %, as sampled = 15.3%
D <sub>(60)</sub> = 1.580 mm	Sand Equivalent = n/a	Req'd Sand Equivalent =
D <sub>(90)</sub> = 12.641 mm	Fracture %, 1 Face = n/a	Req'd Fracture %, 1 Face =
Dust Ratio = 23/72	Fracture %, 2+ Faces = n/a	Req'd Fracture %, 2+ Faces =

ASTM C136, ASTM D6913, ASTM C117

Sieve Size		Actual Cumulative Percent Passing	Interpolated Cumulative Percent Passing	Specs Max	Specs Min
US	Metric				
12.00"	300.00		100%	100.0%	0.0%
10.00"	250.00		100%	100.0%	0.0%
8.00"	200.00		100%	100.0%	0.0%
6.00"	150.00		100%	100.0%	0.0%
4.00"	100.00		100%	100.0%	0.0%
3.00"	75.00		100%	100.0%	0.0%
2.50"	63.00		100%	100.0%	0.0%
2.00"	50.00	100%	100%	100.0%	0.0%
1.75"	45.00		100%	100.0%	0.0%
1.50"	37.50		100%	100.0%	0.0%
1.25"	31.50		100%	100.0%	0.0%
1.00"	25.00	100%	100%	100.0%	0.0%
3/4"	19.00	96%	96%	100.0%	0.0%
5/8"	16.00		93%	100.0%	0.0%
1/2"	12.50	90%	90%	100.0%	0.0%
3/8"	9.50	86%	86%	100.0%	0.0%
1/4"	6.30		79%	100.0%	0.0%
#4	4.75	76%	76%	100.0%	0.0%
#8	2.36		66%	100.0%	0.0%
#10	2.00	65%	65%	100.0%	0.0%
#16	1.18		56%	100.0%	0.0%
#20	0.850	52%	52%	100.0%	0.0%
#30	0.600		42%	100.0%	0.0%
#40	0.425	34%	34%	100.0%	0.0%
#50	0.300		24%	100.0%	0.0%
#60	0.250	20%	20%	100.0%	0.0%
#80	0.180		16%	100.0%	0.0%
#100	0.150	14%	14%	100.0%	0.0%
#140	0.106		12%	100.0%	0.0%
#170	0.090		12%	100.0%	0.0%
#200	0.075	11.0%	11.0%	100.0%	0.0%



Copyright Spears Engineering & Technical Services PS, 1996-98  
 All results apply only to actual locations and materials tested. As a mutual protection to clients, the public and ourselves, all reports are submitted as the confidential property of clients, and authorization for publication of statements, conclusions or extracts from or regarding our reports is reserved pending our written approval.

**Comments:** \_\_\_\_\_

Reviewed by:   
 Meghan Blodgett-Carrillo

# Direct Shear Test Results:

ASTM D-3080



Project: Q.C. - Lower Duwamish Waterway  
 Project Number: 21B233  
 Laboratory Sample ID: B21-2009  
 Sample Date: 7/19/2021  
 Test Date: 10/12/2021  
 Technician: M. Carrillo

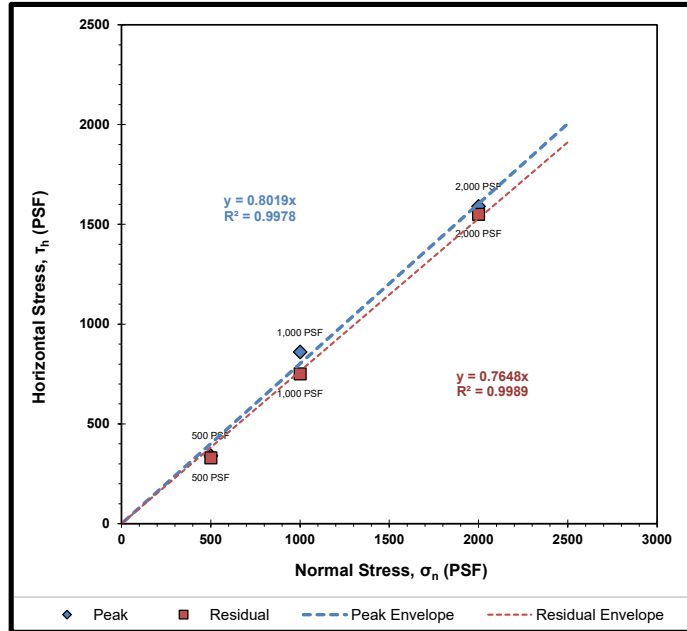
Sample Source: LDW21-GT5-GB-7.5-17.2 ft  
 Visual Soil Description: brown sand  
 Type of Specimen: Remolded Cylindrical Shear Box  
 Specimen Diameter (in): 2.5  
 Specimen Height (in): 1  
 Rate of Strain (in/min): 0.0208  
 Estimated Specific Gravity of Solids: 2.65

Summary of Sample Data: $\sigma_n=500$ PSF		
Initial Moisture Content (%)	25.3	
	Initial	Post-Consolidation
Dry Density (PCF):	106.6	108.7
Void Ratio:	0.580	0.549
Porosity (%):	36.7	35.5
Degree of Saturation (%):	saturated	saturated

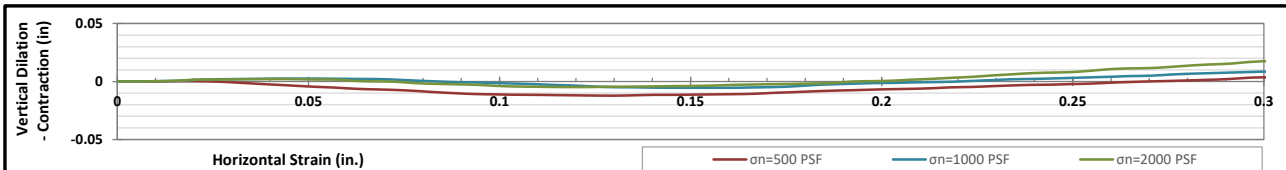
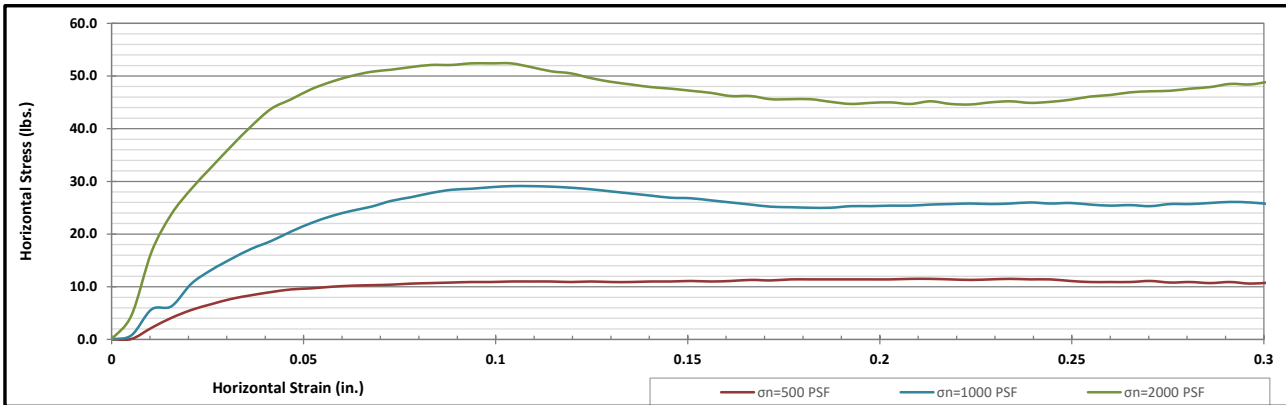
Summary of Sample Data: $\sigma_n=1000$ PSF		
Initial Moisture Content (%)	25.2	
	Initial	Post-Consolidation
Dry Density (PCF):	107.2	109.2
Void Ratio:	0.571	0.543
Porosity (%):	36.3	35.2
Degree of Saturation (%):	saturated	saturated

Summary of Sample Data: $\sigma_n=2000$ PSF		
Initial Moisture Content (%)	25.8	
	Initial	Post-Consolidation
Dry Density (PCF):	106.6	109.4
Void Ratio:	0.581	0.540
Porosity (%):	36.7	35.1
Degree of Saturation (%):	saturated	saturated

ESTIMATED STRENGTH PARAMETERS		
	PEAK	RESIDUAL
Angle of Internal Friction, $\phi$ (°):	39	37
Cohesion (PSF):	0	0



Failure Envelope Test Values:			
Normal Stress, $\sigma_n$ (PSF):	500	1000	2000
Peak Horizontal Stress, $\tau_h$ (PSF):	340	860	1590
Residual Horizontal Stress, $\tau_r$ (PSF):	330	750	1550



Corporate • 777 Chrysler Drive • Burlington, WA 98233 • Phone 360.755.1990 • Fax 360.755.1980  
 SW Region • 2118 Black Lake Blvd. S.W. • Olympia, WA 98512 • Phone 360.534.9777 • Fax 360.534.9779  
 NW Region • 805 Dupont, Suite #5 • Bellingham, WA 98225 • Phone 360.647.6061 • Fax 360.647.8111  
 Kitsap Region • 5451 N.W. Newberry Hill Road, Suite 101 • Silverdale, WA 98383 • Phone/Fax 360.698.6787


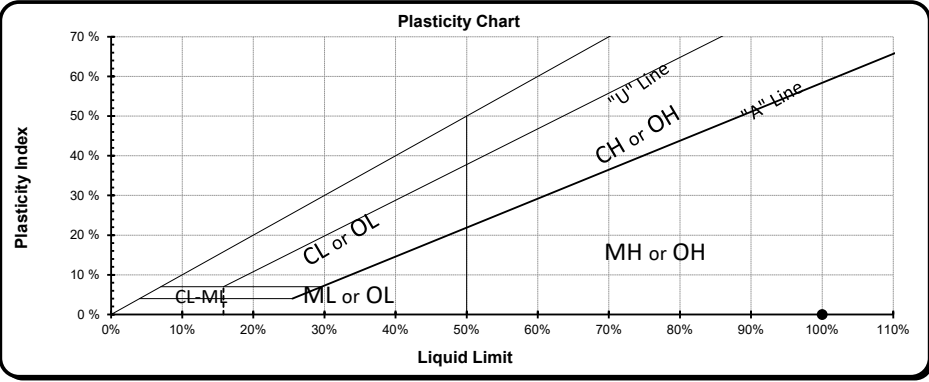
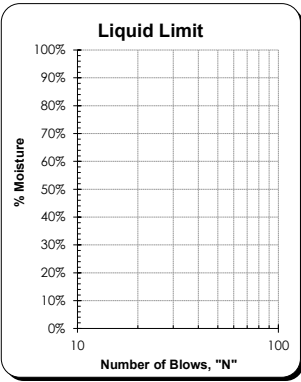
Visit our website: [www.mtc-inc.net](http://www.mtc-inc.net)

# Materials Testing & Consulting, Inc.

Geotechnical Engineering • Special Inspections • Materials Testing • Environmental Consulting



## ASTM D4318 - Liquid Limit, Plastic Limit and Plasticity Index of Soils

<b>Project:</b> Q.C. - Lower Duwamish Waterway <b>Project #:</b> 21B233 <b>Client:</b> Anchor QEA <b>Source:</b> LDW21-GT5-GB-17.2-17.5 ft <b>Sample #:</b> B21-2010	<b>Date Received:</b> 29-Jul-21 <b>Sampled By:</b> Client <b>Date Tested:</b> 14-Oct-21 <b>Tested By:</b> A. Eifrig	<b>Visual Identification</b> Sand with Silt <b>Sample Color</b> brown
<b>Liquid Limit Determination</b>		
#1                  #2                  #3                  #4                  #5                  #6		
<b>Weight of Wet Soils + Pan:</b> <b>Weight of Dry Soils + Pan:</b> <b>Weight of Pan:</b> <b>Weight of Dry Soils:</b> <b>Weight of Moisture:</b> <b>% Moisture:</b> <b>Number of Blows:</b>	Liquid limit cannot be established	
<b>Liquid Limit @ 25 Blows:</b> N/A <b>Plastic Limit:</b> N/A <b>Plasticity Index, I<sub>p</sub>:</b> N/A		
<b>Plastic Limit Determination</b>		
#1                  #2                  #3                  #4                  #5                  #6		
<b>Weight of Wet Soils + Pan:</b> <b>Weight of Dry Soils + Pan:</b> <b>Weight of Pan:</b> <b>Weight of Dry Soils:</b> <b>Weight of Moisture:</b> <b>% Moisture:</b>	Plastic limit cannot be determined	
		
		

Copyright Spears Engineering & Technical Services PS, 1996-98  
 All results apply only to actual locations and materials tested. As a mutual protection to clients, the public and ourselves, all reports are submitted as the confidential property of clients, and authorization for publication of statements, conclusions or extracts from or regarding our reports is reserved pending our written approval.

**Comments:** Liquid limit cannot be established as the material displays rapid dilation upon spreading into the cup. At lower moistures the material does not spread into the liquid limit device without tearing the soil cake. Plastic limit cannot be determined as the material does not roll down to 1/8" threads before cracking or crumbling. Non-plastic.

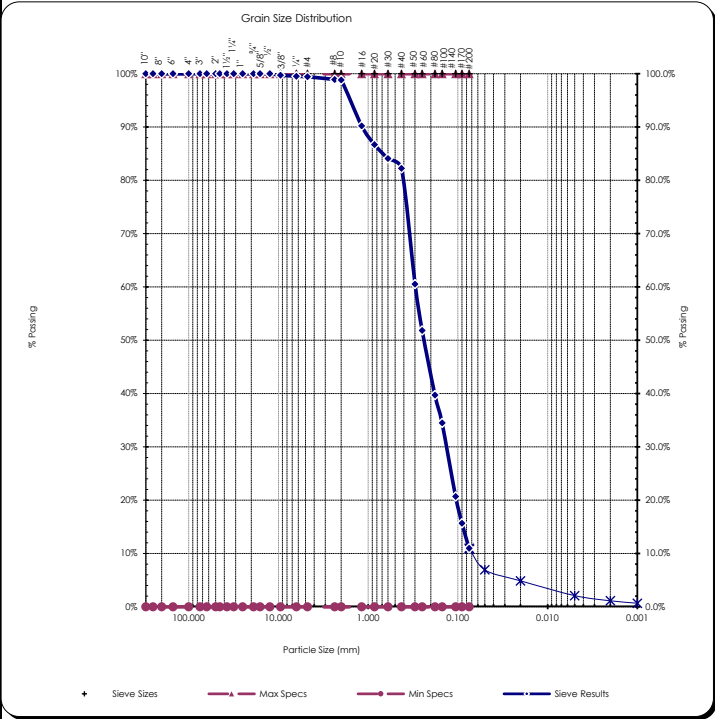
Reviewed by:   
 Meghan Blodgett-Carrillo

# Sieve Report

<b>Project:</b> Q.C. - Lower Duwamish Waterway <b>Project #:</b> 21B233 <b>Client:</b> Anchor QEA <b>Source:</b> LDW21-GT5-GB-17.5-27.5 ft <b>Sample#:</b> B21-2012	<b>Date Received:</b> 29-Jul-21 <b>Sampled By:</b> Client <b>Date Tested:</b> 6-Oct-21 <b>Tested By:</b> K. Mendez	<b>Unified Soil Classification System, ASTM-2487</b> SP-SM, Poorly graded Sand with Silt <b>Sample Color:</b> brown	 Certificate #: 1366.01
---	---	--	----------------------------

<b>ASTM D2216, ASTM D2419, ASTM D4318, ASTM D5281</b>			
<b>Specifications</b> No Specs <b>Sample Meets Specs ?</b> N/A	D <sub>(5)</sub> = 0.022 mm D <sub>(10)</sub> = 0.068 mm D <sub>(15)</sub> = 0.088 mm D <sub>(30)</sub> = 0.136 mm D <sub>(50)</sub> = 0.239 mm D <sub>(60)</sub> = 0.297 mm D <sub>(90)</sub> = 1.161 mm Dust Ratio = 2/15	% Gravel = 0.6% % Sand = 88.5% % Silt & Clay = 11.0% Liquid Limit = n/a Plasticity Index = n/a Sand Equivalent = n/a Fracture %, 1 Face = n/a Fracture %, 2+ Faces = n/a	Coeff. of Curvature, C <sub>c</sub> = 0.91 Coeff. of Uniformity, C <sub>u</sub> = 4.38 Fineness Modulus = 1.33 Plastic Limit = n/a Moisture %, as sampled = 30.6% Req'd Sand Equivalent = Req'd Fracture %, 1 Face = Req'd Fracture %, 2+ Faces =

<b>ASTM C136, ASTM D6913, ASTM C117</b>					
Sieve Size		Actual Cumulative Percent Passing	Interpolated Cumulative Percent Passing	Specs Max	Specs Min
US	Metric				
12.00"	300.00		100%	100.0%	0.0%
10.00"	250.00		100%	100.0%	0.0%
8.00"	200.00		100%	100.0%	0.0%
6.00"	150.00		100%	100.0%	0.0%
4.00"	100.00		100%	100.0%	0.0%
3.00"	75.00		100%	100.0%	0.0%
2.50"	63.00		100%	100.0%	0.0%
2.00"	50.00	100%	100%	100.0%	0.0%
1.75"	45.00	100%	100%	100.0%	0.0%
1.50"	37.50	100%	100%	100.0%	0.0%
1.25"	31.50	100%	100%	100.0%	0.0%
1.00"	25.00	100%	100%	100.0%	0.0%
3/4"	19.00	100%	100%	100.0%	0.0%
5/8"	16.00	100%	100%	100.0%	0.0%
1/2"	12.50	100%	100%	100.0%	0.0%
3/8"	9.50	100%	100%	100.0%	0.0%
1/4"	6.30	100%	100%	100.0%	0.0%
#4	4.75	99%	99%	100.0%	0.0%
#8	2.36	99%	99%	100.0%	0.0%
#10	2.00	99%	99%	100.0%	0.0%
#16	1.18	90%	90%	100.0%	0.0%
#20	0.850	87%	87%	100.0%	0.0%
#30	0.600	84%	84%	100.0%	0.0%
#40	0.425	82%	82%	100.0%	0.0%
#50	0.300	61%	61%	100.0%	0.0%
#60	0.250	52%	52%	100.0%	0.0%
#80	0.180	40%	40%	100.0%	0.0%
#100	0.150	35%	35%	100.0%	0.0%
#140	0.106	21%	21%	100.0%	0.0%
#170	0.090	16%	16%	100.0%	0.0%
#200	0.075	11.0%	11.0%	100.0%	0.0%




Copyright Spears Engineering & Technical Services PS, 1996-98  
 All results apply only to actual locations and materials tested. As a mutual protection to clients, the public and ourselves, all reports are submitted as the confidential property of clients, and authorization for publication of statements, conclusions or extracts from or regarding our reports is reserved pending our written approval.

**Comments:** \_\_\_\_\_

Reviewed by:   
 Meghan Blodgett-Carrillo

## Hydrometer Report

<b>Project:</b> Q.C. - Lower Duwamish Waterway <b>Project #:</b> 21B233 <b>Client:</b> Anchor QEA <b>Source:</b> LDW21-GT5-GB-17.5-27.5 ft <b>Sample#:</b> B21-2012	<b>Date Received:</b> 29-Jul-21 <b>Sampled By:</b> Client <b>Date Tested:</b> 6-Oct-21 <b>Tested By:</b> K. Mendez	<b>Unified Soil Classification System, ASTM-2487</b> SP-SM, Poorly graded Sand with Silt <b>Sample Color</b> brown																																																																																																																																																																											
<b>ASTM D7928, HYDROMETER ANALYSIS</b>		<b>ASTM D6913</b>																																																																																																																																																																											
<table style="width: 100%; border-collapse: collapse;"> <tr> <td style="width: 30%;"><b>Sp Gr.</b></td> <td style="width: 30%; text-align: center;">2.56</td> <td style="width: 40%;"></td> </tr> <tr> <td><b>Sample Weight:</b></td> <td style="text-align: center;">100.01</td> <td>grams</td> </tr> <tr> <td><b>Hydroscopic Moist.:</b></td> <td style="text-align: center;">1.52%</td> <td></td> </tr> <tr> <td><b>Adj. Sample Wgt :</b></td> <td style="text-align: center;">98.51</td> <td>grams</td> </tr> </table> <table style="width: 100%; border-collapse: collapse;"> <tr> <td style="width: 15%;"></td> <td style="width: 15%; text-align: center;"><b>Hydrometer</b></td> <td style="width: 15%;"></td> <td style="width: 15%;"></td> <td style="width: 15%;"></td> <td style="width: 15%;"></td> </tr> <tr> <td></td> <td style="text-align: center;"><b>Reading</b></td> <td style="text-align: center;"><b>Corrected</b></td> <td style="text-align: center;"><b>Percent</b></td> <td style="text-align: center;"><b>Soils Particle</b></td> <td></td> </tr> <tr> <td></td> <td style="text-align: center;"><b>Minutes</b></td> <td style="text-align: center;"><b>Reading</b></td> <td style="text-align: center;"><b>Passing</b></td> <td style="text-align: center;"><b>Diameter</b></td> <td></td> </tr> <tr> <td></td> <td style="text-align: center;">1</td> <td style="text-align: center;">8</td> <td style="text-align: center;">8.2%</td> <td style="text-align: center;">0.0545 mm</td> <td></td> </tr> <tr> <td></td> <td style="text-align: center;">2</td> <td style="text-align: center;">6</td> <td style="text-align: center;">6.1%</td> <td style="text-align: center;">0.0389 mm</td> <td></td> </tr> <tr> <td></td> <td style="text-align: center;">5</td> <td style="text-align: center;">5</td> <td style="text-align: center;">5.1%</td> <td style="text-align: center;">0.0248 mm</td> <td></td> </tr> <tr> <td></td> <td style="text-align: center;">15</td> <td style="text-align: center;">4.5</td> <td style="text-align: center;">4.6%</td> <td style="text-align: center;">0.0144 mm</td> <td></td> </tr> <tr> <td></td> <td style="text-align: center;">30</td> <td style="text-align: center;">4</td> <td style="text-align: center;">4.1%</td> <td style="text-align: center;">0.0102 mm</td> <td></td> </tr> <tr> <td></td> <td style="text-align: center;">60</td> <td style="text-align: center;">3</td> <td style="text-align: center;">3.1%</td> <td style="text-align: center;">0.0072 mm</td> <td></td> </tr> <tr> <td></td> <td style="text-align: center;">240</td> <td style="text-align: center;">1.5</td> <td style="text-align: center;">1.5%</td> <td style="text-align: center;">0.0036 mm</td> <td></td> </tr> <tr> <td></td> <td style="text-align: center;">1440</td> <td style="text-align: center;">1</td> <td style="text-align: center;">1.0%</td> <td style="text-align: center;">0.0015 mm</td> <td></td> </tr> </table> <table style="width: 100%; border-collapse: collapse;"> <tr> <td style="width: 30%;"><b>% Gravel:</b></td> <td style="width: 30%; text-align: center;">0.6%</td> <td style="width: 40%;"></td> </tr> <tr> <td><b>% Sand:</b></td> <td style="text-align: center;">88.5%</td> <td></td> </tr> <tr> <td><b>% Silt:</b></td> <td style="text-align: center;">8.9%</td> <td></td> </tr> <tr> <td><b>% Clay:</b></td> <td style="text-align: center;">2.1%</td> <td></td> </tr> </table> <table style="width: 100%; border-collapse: collapse;"> <tr> <td style="width: 30%;"><b>Liquid Limit:</b></td> <td style="width: 70%; text-align: center;">n/a</td> </tr> <tr> <td><b>Plastic Limit:</b></td> <td style="text-align: center;">n/a</td> </tr> <tr> <td><b>Plasticity Index:</b></td> <td style="text-align: center;">n/a</td> </tr> </table>	<b>Sp Gr.</b>	2.56		<b>Sample Weight:</b>	100.01	grams	<b>Hydroscopic Moist.:</b>	1.52%		<b>Adj. Sample Wgt :</b>	98.51	grams		<b>Hydrometer</b>						<b>Reading</b>	<b>Corrected</b>	<b>Percent</b>	<b>Soils Particle</b>			<b>Minutes</b>	<b>Reading</b>	<b>Passing</b>	<b>Diameter</b>			1	8	8.2%	0.0545 mm			2	6	6.1%	0.0389 mm			5	5	5.1%	0.0248 mm			15	4.5	4.6%	0.0144 mm			30	4	4.1%	0.0102 mm			60	3	3.1%	0.0072 mm			240	1.5	1.5%	0.0036 mm			1440	1	1.0%	0.0015 mm		<b>% Gravel:</b>	0.6%		<b>% Sand:</b>	88.5%		<b>% Silt:</b>	8.9%		<b>% Clay:</b>	2.1%		<b>Liquid Limit:</b>	n/a	<b>Plastic Limit:</b>	n/a	<b>Plasticity Index:</b>	n/a	 <p style="font-size: small;">Certificate #: 1366.01</p>	<table style="width: 100%; border-collapse: collapse;"> <tr> <td colspan="3" style="text-align: center;"><b>Sieve Analysis</b></td> </tr> <tr> <td colspan="3" style="text-align: center;"><b>Grain Size Distribution</b></td> </tr> <tr> <td style="width: 20%;"><b>Sieve Size</b></td> <td style="width: 40%;"><b>Percent Passing</b></td> <td style="width: 40%;"><b>Soils Particle Diameter</b></td> </tr> <tr> <td>3.0"</td> <td style="text-align: center;">100%</td> <td style="text-align: center;">75.000 mm</td> </tr> <tr> <td>2.0"</td> <td style="text-align: center;">100%</td> <td style="text-align: center;">50.000 mm</td> </tr> <tr> <td>1.5"</td> <td style="text-align: center;">100%</td> <td style="text-align: center;">37.500 mm</td> </tr> <tr> <td>1.25"</td> <td style="text-align: center;">100%</td> <td style="text-align: center;">31.500 mm</td> </tr> <tr> <td>1.0"</td> <td style="text-align: center;">100%</td> <td style="text-align: center;">25.000 mm</td> </tr> <tr> <td>3/4"</td> <td style="text-align: center;">100%</td> <td style="text-align: center;">19.000 mm</td> </tr> <tr> <td>5/8"</td> <td style="text-align: center;">100%</td> <td style="text-align: center;">16.000 mm</td> </tr> <tr> <td>1/2"</td> <td style="text-align: center;">100%</td> <td style="text-align: center;">12.500 mm</td> </tr> <tr> <td>3/8"</td> <td style="text-align: center;">100%</td> <td style="text-align: center;">9.500 mm</td> </tr> <tr> <td>1/4"</td> <td style="text-align: center;">100%</td> <td style="text-align: center;">6.300 mm</td> </tr> <tr> <td>#4</td> <td style="text-align: center;">99%</td> <td style="text-align: center;">4.750 mm</td> </tr> <tr> <td>#10</td> <td style="text-align: center;">99%</td> <td style="text-align: center;">2.000 mm</td> </tr> <tr> <td>#20</td> <td style="text-align: center;">87%</td> <td style="text-align: center;">0.850 mm</td> </tr> <tr> <td>#40</td> <td style="text-align: center;">82%</td> <td style="text-align: center;">0.425 mm</td> </tr> <tr> <td>#100</td> <td style="text-align: center;">35%</td> <td style="text-align: center;">0.150 mm</td> </tr> <tr> <td>#200</td> <td style="text-align: center;">11.0%</td> <td style="text-align: center;">0.075 mm</td> </tr> <tr> <td><b>Silts</b></td> <td style="text-align: center;">10.8%</td> <td style="text-align: center;">0.074 mm</td> </tr> <tr> <td></td> <td style="text-align: center;">6.9%</td> <td style="text-align: center;">0.050 mm</td> </tr> <tr> <td></td> <td style="text-align: center;">4.9%</td> <td style="text-align: center;">0.020 mm</td> </tr> <tr> <td><b>Clays</b></td> <td style="text-align: center;">2.1%</td> <td style="text-align: center;">0.005 mm</td> </tr> <tr> <td></td> <td style="text-align: center;">1.1%</td> <td style="text-align: center;">0.002 mm</td> </tr> <tr> <td><b>Colloids</b></td> <td style="text-align: center;">0.7%</td> <td style="text-align: center;">0.001 mm</td> </tr> </table>	<b>Sieve Analysis</b>			<b>Grain Size Distribution</b>			<b>Sieve Size</b>	<b>Percent Passing</b>	<b>Soils Particle Diameter</b>	3.0"	100%	75.000 mm	2.0"	100%	50.000 mm	1.5"	100%	37.500 mm	1.25"	100%	31.500 mm	1.0"	100%	25.000 mm	3/4"	100%	19.000 mm	5/8"	100%	16.000 mm	1/2"	100%	12.500 mm	3/8"	100%	9.500 mm	1/4"	100%	6.300 mm	#4	99%	4.750 mm	#10	99%	2.000 mm	#20	87%	0.850 mm	#40	82%	0.425 mm	#100	35%	0.150 mm	#200	11.0%	0.075 mm	<b>Silts</b>	10.8%	0.074 mm		6.9%	0.050 mm		4.9%	0.020 mm	<b>Clays</b>	2.1%	0.005 mm		1.1%	0.002 mm	<b>Colloids</b>	0.7%	0.001 mm
<b>Sp Gr.</b>	2.56																																																																																																																																																																												
<b>Sample Weight:</b>	100.01	grams																																																																																																																																																																											
<b>Hydroscopic Moist.:</b>	1.52%																																																																																																																																																																												
<b>Adj. Sample Wgt :</b>	98.51	grams																																																																																																																																																																											
	<b>Hydrometer</b>																																																																																																																																																																												
	<b>Reading</b>	<b>Corrected</b>	<b>Percent</b>	<b>Soils Particle</b>																																																																																																																																																																									
	<b>Minutes</b>	<b>Reading</b>	<b>Passing</b>	<b>Diameter</b>																																																																																																																																																																									
	1	8	8.2%	0.0545 mm																																																																																																																																																																									
	2	6	6.1%	0.0389 mm																																																																																																																																																																									
	5	5	5.1%	0.0248 mm																																																																																																																																																																									
	15	4.5	4.6%	0.0144 mm																																																																																																																																																																									
	30	4	4.1%	0.0102 mm																																																																																																																																																																									
	60	3	3.1%	0.0072 mm																																																																																																																																																																									
	240	1.5	1.5%	0.0036 mm																																																																																																																																																																									
	1440	1	1.0%	0.0015 mm																																																																																																																																																																									
<b>% Gravel:</b>	0.6%																																																																																																																																																																												
<b>% Sand:</b>	88.5%																																																																																																																																																																												
<b>% Silt:</b>	8.9%																																																																																																																																																																												
<b>% Clay:</b>	2.1%																																																																																																																																																																												
<b>Liquid Limit:</b>	n/a																																																																																																																																																																												
<b>Plastic Limit:</b>	n/a																																																																																																																																																																												
<b>Plasticity Index:</b>	n/a																																																																																																																																																																												
<b>Sieve Analysis</b>																																																																																																																																																																													
<b>Grain Size Distribution</b>																																																																																																																																																																													
<b>Sieve Size</b>	<b>Percent Passing</b>	<b>Soils Particle Diameter</b>																																																																																																																																																																											
3.0"	100%	75.000 mm																																																																																																																																																																											
2.0"	100%	50.000 mm																																																																																																																																																																											
1.5"	100%	37.500 mm																																																																																																																																																																											
1.25"	100%	31.500 mm																																																																																																																																																																											
1.0"	100%	25.000 mm																																																																																																																																																																											
3/4"	100%	19.000 mm																																																																																																																																																																											
5/8"	100%	16.000 mm																																																																																																																																																																											
1/2"	100%	12.500 mm																																																																																																																																																																											
3/8"	100%	9.500 mm																																																																																																																																																																											
1/4"	100%	6.300 mm																																																																																																																																																																											
#4	99%	4.750 mm																																																																																																																																																																											
#10	99%	2.000 mm																																																																																																																																																																											
#20	87%	0.850 mm																																																																																																																																																																											
#40	82%	0.425 mm																																																																																																																																																																											
#100	35%	0.150 mm																																																																																																																																																																											
#200	11.0%	0.075 mm																																																																																																																																																																											
<b>Silts</b>	10.8%	0.074 mm																																																																																																																																																																											
	6.9%	0.050 mm																																																																																																																																																																											
	4.9%	0.020 mm																																																																																																																																																																											
<b>Clays</b>	2.1%	0.005 mm																																																																																																																																																																											
	1.1%	0.002 mm																																																																																																																																																																											
<b>Colloids</b>	0.7%	0.001 mm																																																																																																																																																																											
<b>USDA Soil Textural Classification</b>																																																																																																																																																																													
<table style="width: 100%; border-collapse: collapse;"> <tr> <td style="width: 30%;"></td> <td style="width: 70%; text-align: center;"><b>Particle Size</b></td> </tr> <tr> <td><b>% Sand:</b></td> <td style="text-align: center;">2.0 - 0.05 mm</td> </tr> <tr> <td><b>% Silt:</b></td> <td style="text-align: center;">0.05 - 0.002 mm</td> </tr> <tr> <td><b>% Clay:</b></td> <td style="text-align: center;">&lt; 0.002 mm</td> </tr> </table> <table style="width: 100%; border-collapse: collapse;"> <tr> <td style="text-align: center;"><b>USDA Soil Textural Classification</b></td> </tr> <tr> <td style="text-align: center;">Sand</td> </tr> </table>		<b>Particle Size</b>	<b>% Sand:</b>	2.0 - 0.05 mm	<b>% Silt:</b>	0.05 - 0.002 mm	<b>% Clay:</b>	< 0.002 mm	<b>USDA Soil Textural Classification</b>	Sand																																																																																																																																																																			
	<b>Particle Size</b>																																																																																																																																																																												
<b>% Sand:</b>	2.0 - 0.05 mm																																																																																																																																																																												
<b>% Silt:</b>	0.05 - 0.002 mm																																																																																																																																																																												
<b>% Clay:</b>	< 0.002 mm																																																																																																																																																																												
<b>USDA Soil Textural Classification</b>																																																																																																																																																																													
Sand																																																																																																																																																																													

All results apply only to actual locations and materials tested. As a mutual protection to clients, the public and ourselves, all reports are submitted as the confidential property of clients, and authorization for publication of statements, conclusions or extracts from or regarding our reports is reserved pending our written approval.

**Comments:** \_\_\_\_\_

\_\_\_\_\_

\_\_\_\_\_

**Reviewed by:** \_\_\_\_\_

  
 Meghan Blodgett-Carrillo

# Materials Testing & Consulting, Inc.

Geotechnical Engineering • Special Inspections • Materials Testing • Environmental Consulting



## ASTM D4318 - Liquid Limit, Plastic Limit and Plasticity Index of Soils

<b>Project:</b> Q.C. - Lower Duwamish Waterway <b>Project #:</b> 21B233 <b>Client:</b> Anchor QEA <b>Source:</b> LDW21-GT35-GB-5-6.5 ft <b>Sample #:</b> B21-2015	<b>Date Received:</b> 29-Jul-21 <b>Sampled By:</b> Client <b>Date Tested:</b> 14-Oct-21 <b>Tested By:</b> K. Mendez	<b>Visual Identification</b> Clay <b>Sample Color</b> brown
---	--	--


Liquid Limit Determination						
	#1	#2	#3	#4	#5	#6
Weight of Wet Soils + Pan:	30.42	27.71	26.95			
Weight of Dry Soils + Pan:	27.89	24.44	23.66			
Weight of Pan:	19.88	15.05	14.81			
Weight of Dry Soils:	8.01	9.39	8.85			
Weight of Moisture:	2.53	3.27	3.29			
% Moisture:	31.6 %	34.8 %	37.2 %			
Number of Blows:	25	20	15			

Plastic Limit Determination						
	#1	#2	#3	#4	#5	#6
Weight of Wet Soils + Pan:	37.34	36.36				
Weight of Dry Soils + Pan:	36.82	35.86				
Weight of Pan:	31.03	30.33				
Weight of Dry Soils:	5.79	5.53				
Weight of Moisture:	0.52	0.50				
% Moisture:	9.0 %	9.0 %				

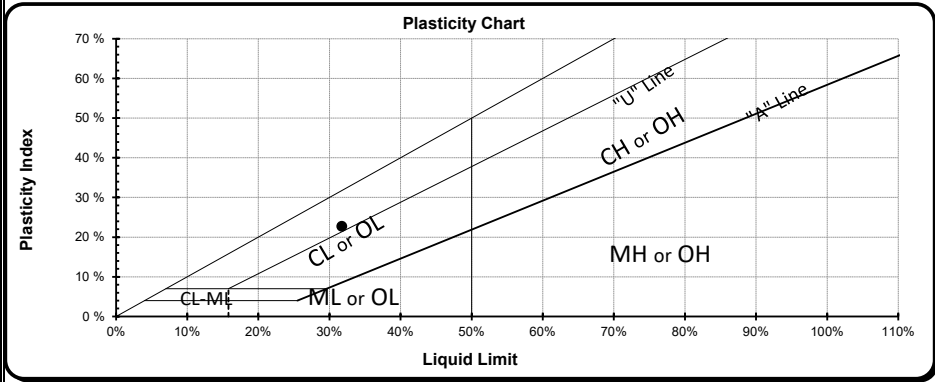
  

**Liquid Limit @ 25 Blows:** 32 %  
**Plastic Limit:** 9 %  
**Plasticity Index, I<sub>p</sub>:** 23 %

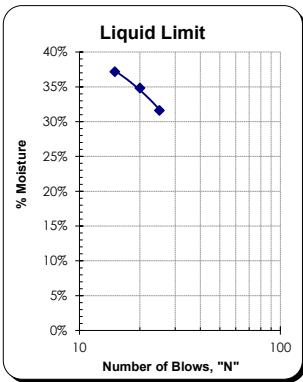


ACCREDITED  
Certificate #: 1366.01, 1366.02 & 1366.04



Copyright Spears Engineering & Technical Services PS, 1996-98



All results apply only to actual locations and materials tested. As a mutual protection to clients, the public and ourselves, all reports are submitted as the confidential property of clients, and authorization for publication of statements, conclusions or extracts from or regarding our reports is reserved pending our written approval.

**Comments:** \_\_\_\_\_

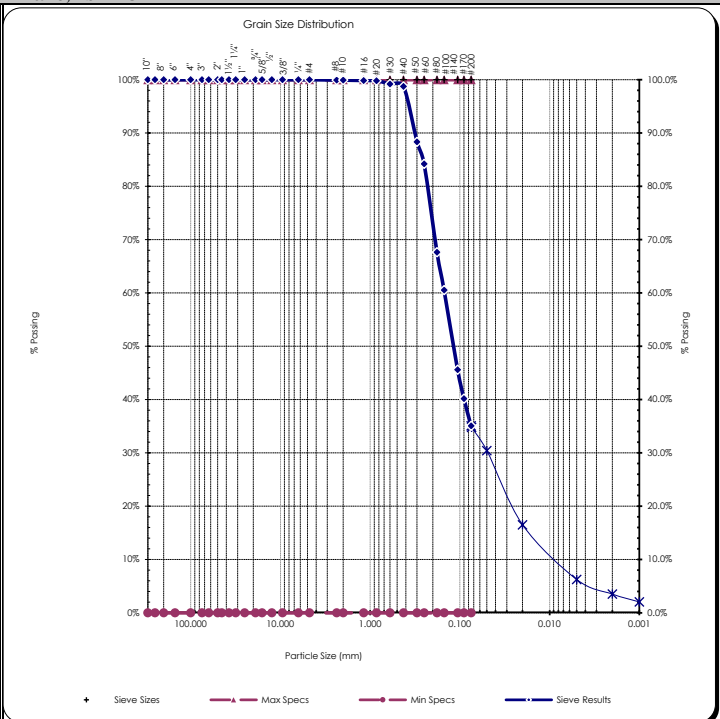
Reviewed by:   
 Meghan Blodgett-Carrillo

# Sieve Report

<b>Project:</b> Q.C. - Lower Duwamish Waterway <b>Project #:</b> 21B233 <b>Client:</b> Anchor QEA <b>Source:</b> LDW21-GT35-GB-15-16.5 ft <b>Sample#:</b> B21-2017	<b>Date Received:</b> 29-Jul-21 <b>Sampled By:</b> Client <b>Date Tested:</b> 6-Oct-21 <b>Tested By:</b> K. Mendez	<b>Unified Soil Classification System, ASTM-2487</b> SM, Silty Sand <b>Sample Color:</b> gray	 <b>ACCREDITED</b> Certificate #: 1366.01
--	---	--	---

<b>ASTM D2216, ASTM D2419, ASTM D4318, ASTM D5281</b>			
<b>Specifications</b> No Specs <b>Sample Meets Specs ?</b> N/A	D <sub>(5)</sub> = 0.004 mm D <sub>(10)</sub> = 0.009 mm D <sub>(15)</sub> = 0.017 mm D <sub>(30)</sub> = 0.057 mm D <sub>(50)</sub> = 0.119 mm D <sub>(60)</sub> = 0.148 mm D <sub>(90)</sub> = 0.320 mm Dust Ratio = 11/31	% Gravel = 0.0% % Sand = 64.9% % Silt & Clay = 35.1% Liquid Limit = n/a Plasticity Index = n/a Sand Equivalent = n/a Fracture %, 1 Face = n/a Fracture %, 2+ Faces = n/a	Coeff. of Curvature, C <sub>c</sub> = 2.36 Coeff. of Uniformity, C <sub>u</sub> = 16.11 Fineness Modulus = 0.52 Plastic Limit = n/a Moisture %, as sampled = 27.4% Req'd Sand Equivalent = Req'd Fracture %, 1 Face = Req'd Fracture %, 2+ Faces =

<b>ASTM C136, ASTM D6913, ASTM C117</b>					
Sieve Size		Actual Cumulative Percent Passing	Interpolated Cumulative Percent Passing	Specs Max	Specs Min
US	Metric				
12.00"	300.00		100%	100.0%	0.0%
10.00"	250.00		100%	100.0%	0.0%
8.00"	200.00		100%	100.0%	0.0%
6.00"	150.00		100%	100.0%	0.0%
4.00"	100.00		100%	100.0%	0.0%
3.00"	75.00		100%	100.0%	0.0%
2.50"	63.00		100%	100.0%	0.0%
2.00"	50.00	100%	100%	100.0%	0.0%
1.75"	45.00	100%	100%	100.0%	0.0%
1.50"	37.50	100%	100%	100.0%	0.0%
1.25"	31.50	100%	100%	100.0%	0.0%
1.00"	25.00	100%	100%	100.0%	0.0%
3/4"	19.00	100%	100%	100.0%	0.0%
5/8"	16.00	100%	100%	100.0%	0.0%
1/2"	12.50	100%	100%	100.0%	0.0%
3/8"	9.50	100%	100%	100.0%	0.0%
1/4"	6.30	100%	100%	100.0%	0.0%
#4	4.75	100%	100%	100.0%	0.0%
#8	2.36	100%	100%	100.0%	0.0%
#10	2.00	100%	100%	100.0%	0.0%
#16	1.18	100%	100%	100.0%	0.0%
#20	0.850	100%	100%	100.0%	0.0%
#30	0.600	99%	99%	100.0%	0.0%
#40	0.425	99%	99%	100.0%	0.0%
#50	0.300	88%	88%	100.0%	0.0%
#60	0.250	84%	84%	100.0%	0.0%
#80	0.180	68%	68%	100.0%	0.0%
#100	0.150	61%	61%	100.0%	0.0%
#140	0.106	46%	46%	100.0%	0.0%
#170	0.090	40%	40%	100.0%	0.0%
#200	0.075	35.1%	35.1%	100.0%	0.0%



Copyright Spears Engineering & Technical Services PS, 1996-98  
 All results apply only to actual locations and materials tested. As a mutual protection to clients, the public and ourselves, all reports are submitted as the confidential property of clients, and authorization for publication of statements, conclusions or extracts from or regarding our reports is reserved pending our written approval.

**Comments:** \_\_\_\_\_

Reviewed by:   
 Meghan Blodgett-Carrillo



# Hydrometer Report

<b>Project:</b> Q.C. - Lower Duwamish Waterway <b>Project #:</b> 21B233 <b>Client:</b> Anchor QEA <b>Source:</b> LDW21-GT35-GB-15-16.5 ft <b>Sample#:</b> B21-2017	<b>Date Received:</b> 29-Jul-21 <b>Sampled By:</b> Client <b>Date Tested:</b> 6-Oct-21 <b>Tested By:</b> K. Mendez	<b>Unified Soil Classification System, ASTM-2487</b> SM, Silty Sand <b>Sample Color</b> gray																																																																																																																																											
<b>ASTM D7928, HYDROMETER ANALYSIS</b>		<b>ASTM D6913</b>																																																																																																																																											
<table style="width: 100%;"> <tr> <td style="width: 30%;"><b>Sp Gr.</b></td> <td style="width: 30%;">2.59</td> <td style="width: 40%;"></td> </tr> <tr> <td><b>Sample Weight:</b></td> <td>102.29</td> <td>grams</td> </tr> <tr> <td><b>Hydroscopic Moist.:</b></td> <td>1.10%</td> <td></td> </tr> <tr> <td><b>Adj. Sample Wgt :</b></td> <td>101.18</td> <td>grams</td> </tr> </table> <table style="width: 100%;"> <tr> <td style="width: 30%;"><b>Hydrometer Reading</b></td> <td style="width: 30%;"><b>Corrected Reading</b></td> <td style="width: 30%;"><b>Percent Passing</b></td> <td style="width: 10%;"><b>Soils Particle Diameter</b></td> </tr> <tr> <td>1</td> <td>27.5</td> <td>27.7%</td> <td>0.0486 mm</td> </tr> <tr> <td>2</td> <td>23</td> <td>23.2%</td> <td>0.0352 mm</td> </tr> <tr> <td>5</td> <td>18</td> <td>18.1%</td> <td>0.0230 mm</td> </tr> <tr> <td>15</td> <td>13</td> <td>13.1%</td> <td>0.0137 mm</td> </tr> <tr> <td>30</td> <td>10.5</td> <td>10.6%</td> <td>0.0099 mm</td> </tr> <tr> <td>60</td> <td>8</td> <td>8.1%</td> <td>0.0070 mm</td> </tr> <tr> <td>240</td> <td>5</td> <td>5.0%</td> <td>0.0036 mm</td> </tr> <tr> <td>1440</td> <td>3</td> <td>3.0%</td> <td>0.0015 mm</td> </tr> </table> <table style="width: 100%;"> <tr> <td style="width: 30%;"><b>% Gravel:</b></td> <td style="width: 30%;">0.0%</td> <td style="width: 30%;"><b>Liquid Limit:</b></td> <td style="width: 10%;">n/a</td> </tr> <tr> <td><b>% Sand:</b></td> <td>64.9%</td> <td><b>Plastic Limit:</b></td> <td>n/a</td> </tr> <tr> <td><b>% Silt:</b></td> <td>28.8%</td> <td><b>Plasticity Index:</b></td> <td>n/a</td> </tr> <tr> <td><b>% Clay:</b></td> <td>6.3%</td> <td></td> <td></td> </tr> </table>	<b>Sp Gr.</b>	2.59		<b>Sample Weight:</b>	102.29	grams	<b>Hydroscopic Moist.:</b>	1.10%		<b>Adj. Sample Wgt :</b>	101.18	grams	<b>Hydrometer Reading</b>	<b>Corrected Reading</b>	<b>Percent Passing</b>	<b>Soils Particle Diameter</b>	1	27.5	27.7%	0.0486 mm	2	23	23.2%	0.0352 mm	5	18	18.1%	0.0230 mm	15	13	13.1%	0.0137 mm	30	10.5	10.6%	0.0099 mm	60	8	8.1%	0.0070 mm	240	5	5.0%	0.0036 mm	1440	3	3.0%	0.0015 mm	<b>% Gravel:</b>	0.0%	<b>Liquid Limit:</b>	n/a	<b>% Sand:</b>	64.9%	<b>Plastic Limit:</b>	n/a	<b>% Silt:</b>	28.8%	<b>Plasticity Index:</b>	n/a	<b>% Clay:</b>	6.3%				<table style="width: 100%;"> <tr> <th colspan="3" style="text-align: center;">Sieve Analysis</th> </tr> <tr> <th colspan="3" style="text-align: center;">Grain Size Distribution</th> </tr> <tr> <th style="width: 30%;">Sieve Size</th> <th style="width: 30%;">Percent Passing</th> <th style="width: 40%;">Soils Particle Diameter</th> </tr> <tr> <td>3.0"</td> <td>100%</td> <td>75.000 mm</td> </tr> <tr> <td>2.0"</td> <td>100%</td> <td>50.000 mm</td> </tr> <tr> <td>1.5"</td> <td>100%</td> <td>37.500 mm</td> </tr> <tr> <td>1.25"</td> <td>100%</td> <td>31.500 mm</td> </tr> <tr> <td>1.0"</td> <td>100%</td> <td>25.000 mm</td> </tr> <tr> <td>3/4"</td> <td>100%</td> <td>19.000 mm</td> </tr> <tr> <td>5/8"</td> <td>100%</td> <td>16.000 mm</td> </tr> <tr> <td>1/2"</td> <td>100%</td> <td>12.500 mm</td> </tr> <tr> <td>3/8"</td> <td>100%</td> <td>9.500 mm</td> </tr> <tr> <td>1/4"</td> <td>100%</td> <td>6.300 mm</td> </tr> <tr> <td>#4</td> <td>100%</td> <td>4.750 mm</td> </tr> <tr> <td>#10</td> <td>100%</td> <td>2.000 mm</td> </tr> <tr> <td>#20</td> <td>100%</td> <td>0.850 mm</td> </tr> <tr> <td>#40</td> <td>99%</td> <td>0.425 mm</td> </tr> <tr> <td>#100</td> <td>61%</td> <td>0.150 mm</td> </tr> <tr> <td>#200</td> <td>35.1%</td> <td>0.075 mm</td> </tr> <tr> <td><b>Silts</b></td> <td><b>34.8%</b></td> <td><b>0.074 mm</b></td> </tr> <tr> <td></td> <td>30.4%</td> <td>0.050 mm</td> </tr> <tr> <td></td> <td>16.5%</td> <td>0.020 mm</td> </tr> <tr> <td><b>Clays</b></td> <td><b>6.3%</b></td> <td><b>0.005 mm</b></td> </tr> <tr> <td></td> <td>3.5%</td> <td>0.002 mm</td> </tr> <tr> <td><b>Colloids</b></td> <td><b>2.0%</b></td> <td><b>0.001 mm</b></td> </tr> </table>	Sieve Analysis			Grain Size Distribution			Sieve Size	Percent Passing	Soils Particle Diameter	3.0"	100%	75.000 mm	2.0"	100%	50.000 mm	1.5"	100%	37.500 mm	1.25"	100%	31.500 mm	1.0"	100%	25.000 mm	3/4"	100%	19.000 mm	5/8"	100%	16.000 mm	1/2"	100%	12.500 mm	3/8"	100%	9.500 mm	1/4"	100%	6.300 mm	#4	100%	4.750 mm	#10	100%	2.000 mm	#20	100%	0.850 mm	#40	99%	0.425 mm	#100	61%	0.150 mm	#200	35.1%	0.075 mm	<b>Silts</b>	<b>34.8%</b>	<b>0.074 mm</b>		30.4%	0.050 mm		16.5%	0.020 mm	<b>Clays</b>	<b>6.3%</b>	<b>0.005 mm</b>		3.5%	0.002 mm	<b>Colloids</b>	<b>2.0%</b>	<b>0.001 mm</b>
<b>Sp Gr.</b>	2.59																																																																																																																																												
<b>Sample Weight:</b>	102.29	grams																																																																																																																																											
<b>Hydroscopic Moist.:</b>	1.10%																																																																																																																																												
<b>Adj. Sample Wgt :</b>	101.18	grams																																																																																																																																											
<b>Hydrometer Reading</b>	<b>Corrected Reading</b>	<b>Percent Passing</b>	<b>Soils Particle Diameter</b>																																																																																																																																										
1	27.5	27.7%	0.0486 mm																																																																																																																																										
2	23	23.2%	0.0352 mm																																																																																																																																										
5	18	18.1%	0.0230 mm																																																																																																																																										
15	13	13.1%	0.0137 mm																																																																																																																																										
30	10.5	10.6%	0.0099 mm																																																																																																																																										
60	8	8.1%	0.0070 mm																																																																																																																																										
240	5	5.0%	0.0036 mm																																																																																																																																										
1440	3	3.0%	0.0015 mm																																																																																																																																										
<b>% Gravel:</b>	0.0%	<b>Liquid Limit:</b>	n/a																																																																																																																																										
<b>% Sand:</b>	64.9%	<b>Plastic Limit:</b>	n/a																																																																																																																																										
<b>% Silt:</b>	28.8%	<b>Plasticity Index:</b>	n/a																																																																																																																																										
<b>% Clay:</b>	6.3%																																																																																																																																												
Sieve Analysis																																																																																																																																													
Grain Size Distribution																																																																																																																																													
Sieve Size	Percent Passing	Soils Particle Diameter																																																																																																																																											
3.0"	100%	75.000 mm																																																																																																																																											
2.0"	100%	50.000 mm																																																																																																																																											
1.5"	100%	37.500 mm																																																																																																																																											
1.25"	100%	31.500 mm																																																																																																																																											
1.0"	100%	25.000 mm																																																																																																																																											
3/4"	100%	19.000 mm																																																																																																																																											
5/8"	100%	16.000 mm																																																																																																																																											
1/2"	100%	12.500 mm																																																																																																																																											
3/8"	100%	9.500 mm																																																																																																																																											
1/4"	100%	6.300 mm																																																																																																																																											
#4	100%	4.750 mm																																																																																																																																											
#10	100%	2.000 mm																																																																																																																																											
#20	100%	0.850 mm																																																																																																																																											
#40	99%	0.425 mm																																																																																																																																											
#100	61%	0.150 mm																																																																																																																																											
#200	35.1%	0.075 mm																																																																																																																																											
<b>Silts</b>	<b>34.8%</b>	<b>0.074 mm</b>																																																																																																																																											
	30.4%	0.050 mm																																																																																																																																											
	16.5%	0.020 mm																																																																																																																																											
<b>Clays</b>	<b>6.3%</b>	<b>0.005 mm</b>																																																																																																																																											
	3.5%	0.002 mm																																																																																																																																											
<b>Colloids</b>	<b>2.0%</b>	<b>0.001 mm</b>																																																																																																																																											
<b>USDA Soil Textural Classification</b>																																																																																																																																													
<table style="width: 100%;"> <tr> <td style="width: 30%;"><b>% Sand:</b></td> <td style="width: 70%;">2.0 - 0.05 mm</td> </tr> <tr> <td><b>% Silt:</b></td> <td>0.05 - 0.002 mm</td> </tr> <tr> <td><b>% Clay:</b></td> <td>&lt; 0.002 mm</td> </tr> </table> <p style="text-align: center;"><b>USDA Soil Textural Classification</b> Sandy Loam</p>	<b>% Sand:</b>	2.0 - 0.05 mm	<b>% Silt:</b>	0.05 - 0.002 mm	<b>% Clay:</b>	< 0.002 mm																																																																																																																																							
<b>% Sand:</b>	2.0 - 0.05 mm																																																																																																																																												
<b>% Silt:</b>	0.05 - 0.002 mm																																																																																																																																												
<b>% Clay:</b>	< 0.002 mm																																																																																																																																												

All results apply only to actual locations and materials tested. As a mutual protection to clients, the public and ourselves, all reports are submitted as the confidential property of clients, and authorization for publication of statements, conclusions or extracts from or regarding our reports is reserved pending our written approval.

**Comments:** \_\_\_\_\_

\_\_\_\_\_

\_\_\_\_\_

**Reviewed by:** \_\_\_\_\_  
 Meghan Blodgett-Carrillo

# Direct Shear Test Results:

ASTM D-3080



Project: Q.C. - Lower Duwamish Waterway  
 Project Number: 21B233  
 Laboratory Sample ID: B21-2017  
 Sample Date: 7/20/2021  
 Test Date: 10/6/2021  
 Technician: M. Carrillo

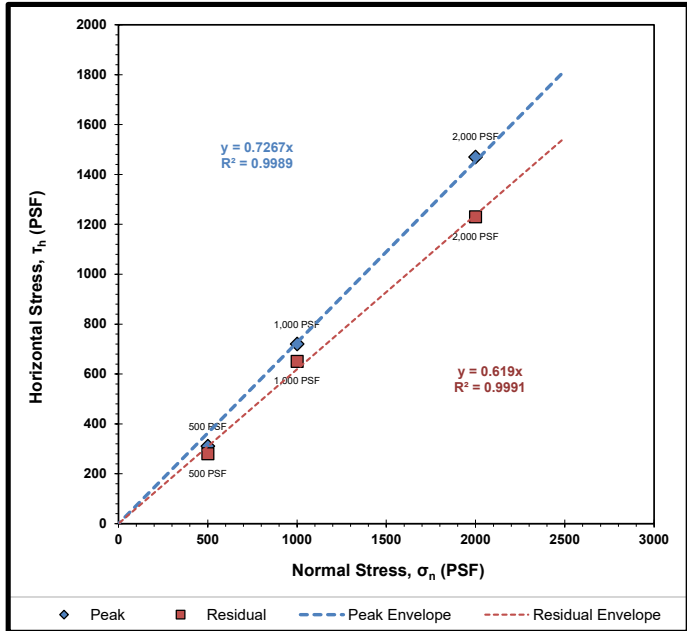
Sample Source: LDW21-GT35-GB-15-16.5 ft  
 Visual Soil Description: gray sand  
 Type of Specimen: Remolded Cylindrical Shear Box  
 Specimen Diameter (in): 2.5  
 Specimen Height (in): 1  
 Rate of Strain (in/min): 0.0208  
 Estimated Specific Gravity of Solids: 2.65

Summary of Sample Data: $\sigma_n=500$ PSF		
Initial Moisture Content (%)	29.5	
	Initial	Post-Consolidation
Dry Density (PCF):	109.5	110.5
Void Ratio:	0.539	0.525
Porosity (%):	35.0	34.4
Degree of Saturation (%):	saturated	saturated

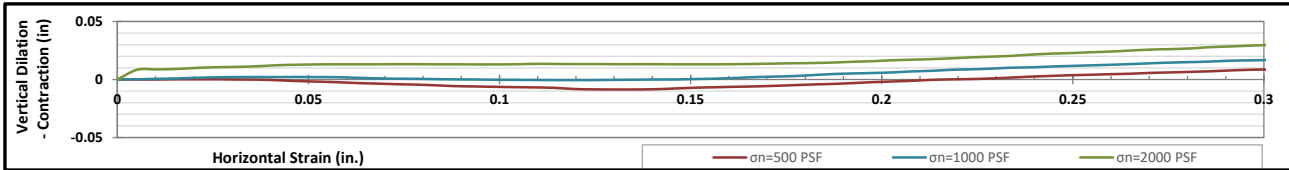
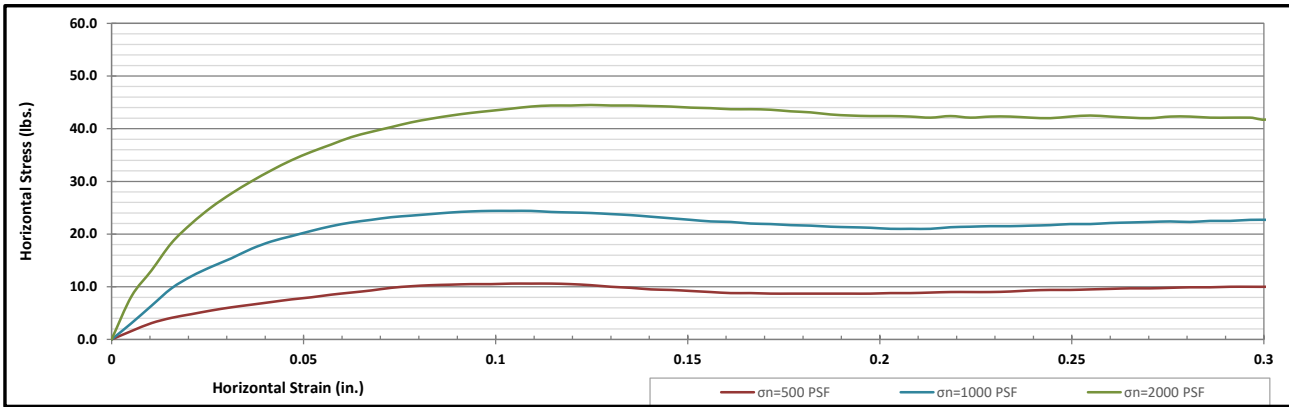
Summary of Sample Data: $\sigma_n=1000$ PSF		
Initial Moisture Content (%)	30.1	
	Initial	Post-Consolidation
Dry Density (PCF):	108.1	110.4
Void Ratio:	0.559	0.527
Porosity (%):	35.8	34.5
Degree of Saturation (%):	saturated	saturated

Summary of Sample Data: $\sigma_n=2000$ PSF		
Initial Moisture Content (%)	32.2	
	Initial	Post-Consolidation
Dry Density (PCF):	107.5	110.7
Void Ratio:	0.567	0.522
Porosity (%):	36.2	34.3
Degree of Saturation (%):	saturated	saturated

ESTIMATED STRENGTH PARAMETERS		
	PEAK	RESIDUAL
Angle of Internal Friction, $\phi$ (°):	36	32
Cohesion (PSF):	0	0



Failure Envelope Test Values:			
Normal Stress, $\sigma_n$ (PSF):	500	1000	2000
Peak Horizontal Stress, $\tau_h$ (PSF):	310	720	1470
Residual Horizontal Stress, $\tau_r$ (PSF):	280	650	1230



Corporate • 777 Chrysler Drive • Burlington, WA 98233 • Phone 360.755.1990 • Fax 360.755.1980  
 SW Region • 2118 Black Lake Blvd. S.W. • Olympia, WA 98512 • Phone 360.534.9777 • Fax 360.534.9779  
 NW Region • 805 Dupont, Suite #5 • Bellingham, WA 98225 • Phone 360.647.6061 • Fax 360.647.8111  
 Kitsap Region • 5451 N.W. Newberry Hill Road, Suite 101 • Silverdale, WA 98383 • Phone/Fax 360.698.6787

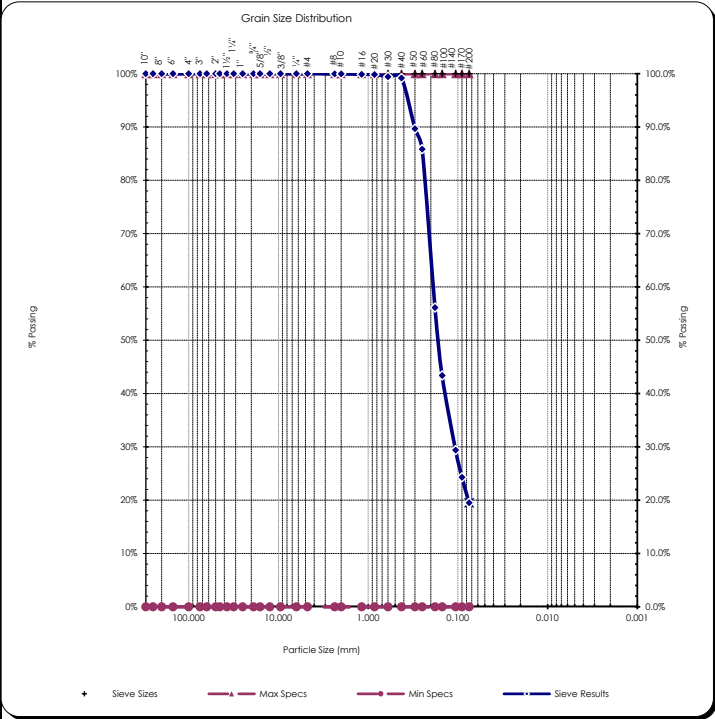
Visit our website: [www.mtc-inc.net](http://www.mtc-inc.net)

# Sieve Report

<b>Project:</b> Q.C. - Lower Duwamish Waterway <b>Project #:</b> 21B233 <b>Client:</b> Anchor QEA <b>Source:</b> LDW21-GT35-GB-20-21.5 ft <b>Sample#:</b> B21-2018	<b>Date Received:</b> 29-Jul-21 <b>Sampled By:</b> Client <b>Date Tested:</b> 6-Oct-21 <b>Tested By:</b> K. Mendez	<b>Unified Soil Classification System, ASTM-2487</b> SM, Silty Sand <b>Sample Color:</b> brown	 <b>ACCREDITED</b> Certificate #: 1366.01
--	---	---	---

<b>ASTM D2216, ASTM D2419, ASTM D4318, ASTM D5281</b>			
<b>Specifications</b> No Specs <b>Sample Meets Specs ?</b> N/A	D <sub>(5)</sub> = 0.019 mm D <sub>(10)</sub> = 0.038 mm D <sub>(15)</sub> = 0.058 mm D <sub>(30)</sub> = 0.108 mm D <sub>(50)</sub> = 0.166 mm D <sub>(60)</sub> = 0.189 mm D <sub>(90)</sub> = 0.304 mm Dust Ratio = 13/66	% Gravel = 0.0% % Sand = 80.5% % Silt & Clay = 19.5% Liquid Limit = n/a Plasticity Index = n/a Sand Equivalent = n/a Fracture %, 1 Face = n/a Fracture %, 2+ Faces = n/a	Coeff. of Curvature, C <sub>c</sub> = 1.60 Coeff. of Uniformity, C <sub>u</sub> = 4.92 Fineness Modulus = 0.68 Plastic Limit = n/a Moisture %, as sampled = 27.6% Req'd Sand Equivalent = Req'd Fracture %, 1 Face = Req'd Fracture %, 2+ Faces =

<b>ASTM C136, ASTM D6913, ASTM C117</b>					
Sieve Size		Actual Cumulative Percent Passing	Interpolated Cumulative Percent Passing	Specs Max	Specs Min
US	Metric				
12.00"	300.00		100%	100.0%	0.0%
10.00"	250.00		100%	100.0%	0.0%
8.00"	200.00		100%	100.0%	0.0%
6.00"	150.00		100%	100.0%	0.0%
4.00"	100.00		100%	100.0%	0.0%
3.00"	75.00		100%	100.0%	0.0%
2.50"	63.00		100%	100.0%	0.0%
2.00"	50.00	100%	100%	100.0%	0.0%
1.75"	45.00	100%	100%	100.0%	0.0%
1.50"	37.50	100%	100%	100.0%	0.0%
1.25"	31.50	100%	100%	100.0%	0.0%
1.00"	25.00	100%	100%	100.0%	0.0%
3/4"	19.00	100%	100%	100.0%	0.0%
5/8"	16.00	100%	100%	100.0%	0.0%
1/2"	12.50	100%	100%	100.0%	0.0%
3/8"	9.50	100%	100%	100.0%	0.0%
1/4"	6.30	100%	100%	100.0%	0.0%
#4	4.75	100%	100%	100.0%	0.0%
#8	2.36	100%	100%	100.0%	0.0%
#10	2.00	100%	100%	100.0%	0.0%
#16	1.18	100%	100%	100.0%	0.0%
#20	0.850	100%	100%	100.0%	0.0%
#30	0.600	99%	99%	100.0%	0.0%
#40	0.425	99%	99%	100.0%	0.0%
#50	0.300	90%	90%	100.0%	0.0%
#60	0.250	86%	86%	100.0%	0.0%
#80	0.180	56%	56%	100.0%	0.0%
#100	0.150	43%	43%	100.0%	0.0%
#140	0.106	29%	29%	100.0%	0.0%
#170	0.090	24%	24%	100.0%	0.0%
#200	0.075	19.5%	19.5%	100.0%	0.0%



Copyright Spears Engineering & Technical Services PS, 1996-98  
 All results apply only to actual locations and materials tested. As a mutual protection to clients, the public and ourselves, all reports are submitted as the confidential property of clients, and authorization for publication of statements, conclusions or extracts from or regarding our reports is reserved pending our written approval.

**Comments:** \_\_\_\_\_


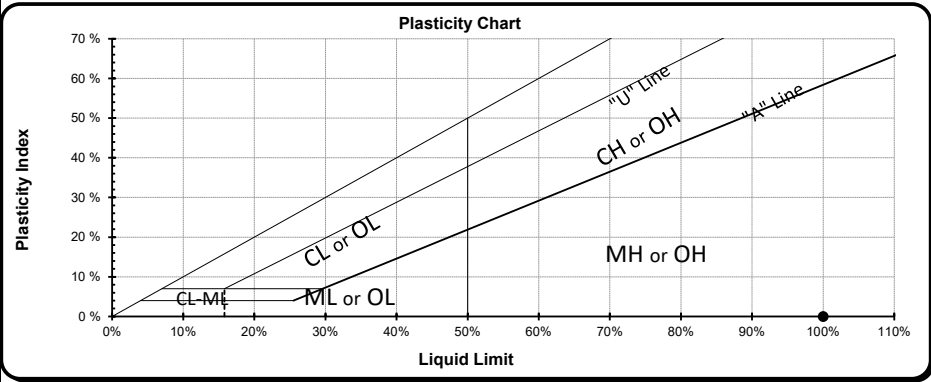
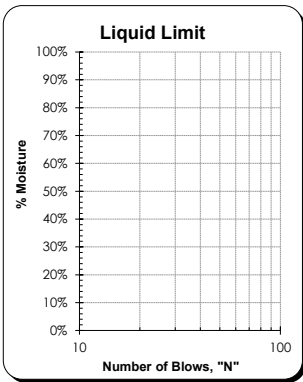
Reviewed by:   
 Meghan Blodgett-Carrillo

# Materials Testing & Consulting, Inc.

Geotechnical Engineering • Special Inspections • Materials Testing • Environmental Consulting



## ASTM D4318 - Liquid Limit, Plastic Limit and Plasticity Index of Soils

<b>Project:</b> Q.C. - Lower Duwamish Waterway <b>Project #:</b> 21B233 <b>Client:</b> Anchor QEA <b>Source:</b> LDW21-GT35-GB-30-31.5 ft <b>Sample #:</b> B21-2020	<b>Date Received:</b> 29-Jul-21 <b>Sampled By:</b> Client <b>Date Tested:</b> 14-Oct-21 <b>Tested By:</b> A. Eifrig	<b>Visual Identification</b> Silty Sand <b>Sample Color</b> brown
<b>Liquid Limit Determination</b>		
#1                  #2                  #3                  #4                  #5                  #6		
<b>Weight of Wet Soils + Pan:</b> <b>Weight of Dry Soils + Pan:</b> <b>Weight of Pan:</b> <b>Weight of Dry Soils:</b> <b>Weight of Moisture:</b> <b>% Moisture:</b> <b>Number of Blows:</b>	Liquid limit cannot be established	
<b>Liquid Limit @ 25 Blows:</b> N/A <b>Plastic Limit:</b> N/A <b>Plasticity Index, I<sub>p</sub>:</b> N/A		
<b>Plastic Limit Determination</b>		
#1                  #2                  #3                  #4                  #5                  #6		
<b>Weight of Wet Soils + Pan:</b> <b>Weight of Dry Soils + Pan:</b> <b>Weight of Pan:</b> <b>Weight of Dry Soils:</b> <b>Weight of Moisture:</b> <b>% Moisture:</b>	Plastic limit cannot be determined	
		
		

Copyright Spears Engineering & Technical Services PS, 1996-98  
 All results apply only to actual locations and materials tested. As a mutual protection to clients, the public and ourselves, all reports are submitted as the confidential property of clients, and authorization for publication of statements, conclusions or extracts from or regarding our reports is reserved pending our written approval.

**Comments:** Liquid limit cannot be established as the material displays rapid dilation upon spreading into the cup. At lower moistures the material does not spread into the liquid limit device without tearing the soil cake. Plastic limit cannot be determined as the material does not roll down to 1/8" threads before cracking or crumbling. Non-plastic.

Reviewed by:   
 Meghan Blodgett-Carrillo



**Client:** Anchor QEA  
**Address:** 21328 2nd Drive SE  
Bothell, WA 98021  
**Attn:** Garrett Timm  
**Revised on:** \_\_\_\_\_

**Date:** October 25, 2021  
**Project:** Q.C. - Lower Duwamish Waterway  
**Project #:** 21B233  
**Sample #:** B21-2143-2162  
**Date sampled:** August 5, 2021

As requested MTC, Inc. has performed the following test(s) on the sample referenced above. The testing was performed in accordance with current applicable AASHTO or ASTM standards as indicated below. The results obtained in our laboratory were as follows below or on the attached pages:

	Test(s) Performed:	Test Results		Test(s) Performed:	Test Results
X	Sieve Analysis	Please See Attached Reports		Sulfate Soundness	
	Proctor			Bulk Density & Voids	
	Sand Equivalent			WSDOT Degradation	
	Fracture Count			LA Abrasion	
X	Moisture Content	Please See Attached Report	X	Direct Shear	Please See Attached Reports
	Specific Gravity, Coarse		X	Specific Gravity, Soils	Please See Attached Reports
	Specific Gravity, Fine				
X	Hydrometer Analysis	Please See Attached Reports			
X	Atterberg Limits	Please See Attached Reports			

If you have any questions concerning the test results, the procedures used, or if we can be of any further assistance please call on us at the number below.

Respectfully Submitted,  
 Meghan Blodgett-Carrillo  
 WABO Supervising Laboratory Technician




## Moisture Content - ASTM C566, ASTM D2216

**Project:** Q.C. - Lower Duwamish Waterway  
**Project #:** 21B233  
**Date Received:** July 29, 2021  
**Date Tested:** October 15, 2021

**Client:** Anchor QEA  
**Sampled by:** Client  
**Tested by:** A. Eifrig

Sample #	Location	Tare	Wet + Tare	Dry + Tare	Wgt. Of Moisture	Wgt. Of Soil	% Moisture
B21-2143	LDW21-GT48-GB-21.6-25 ft	234.6	512.3	437.5	74.8	202.9	36.9%
B21-2144	LDW21-GT48-GB-25-30 ft	221.6	1232.1	959.0	273.1	737.4	37.0%
B21-2145	LDW21-GT48-GB-30-35 ft	215.3	1034.5	826.3	208.2	611.0	34.1%
B21-2146	LDW21-GT48-GB-35-36.5 ft	235.3	1073.2	832.7	240.5	597.4	40.3%
B21-2147	LDW21-GT53-GB-0-1.5 ft	228.9	845.1	638.7	206.4	409.8	50.4%
B21-2148	LDW21-GT53-GB-0-5 ft	208.5	682.6	526.4	156.2	317.9	49.1%
B21-2149	LDW21-GT53-GB-5-6.5 ft	222.9	1006.1	801.8	204.3	578.9	35.3%
B21-2150	LDW21-GT53-GB-5-10 ft	229.4	762.5	595.5	167.0	366.1	45.6%
B21-2151	LDW21-GT53-GB-10-15 ft	221.1	1092.3	749.6	342.7	528.5	64.8%
B21-2152	LDW21-GT53-GB-15-20 ft	220.4	805.0	678.3	126.7	457.9	27.7%
B21-2153	LDW21-GT53-GB-20-23.5 ft	222.9	998.0	819.4	178.6	596.5	29.9%
B21-2154	LDW21-GT53-GB-23.5-25 ft	217.3	990.1	795.4	194.7	578.1	33.7%
B21-2155	LDW21-GT53-GB-25-28.6 ft	222.6	807.8	656.4	151.4	433.8	34.9%
B21-2156	LDW21-GT53-GB-28.6-30 ft	224.3	929.6	800.4	129.2	576.1	22.4%
B21-2157	LDW21-GT48-SPT-0-0.7 ft	268.9	742.1	658.8	83.3	389.9	21.4%
B21-2158	LDW21-GT48-SPT-0.7-1.5 ft	310.9	685.1	612.8	72.3	301.9	23.9%
B21-2159	LDW21-GT48-SPT-10-11.5 ft	319.8	870.6	717.8	152.8	398.0	38.4%
B21-2160	LDW21-GT48-SPT-15-16.5 ft	301.0	852.0	723.3	128.7	422.3	30.5%
B21-2161	LDW21-GT48-SPT-20-20.6 ft	302.0	675.6	567.7	107.9	265.7	40.6%
B21-2162	LDW21-GT48-SPT-20.6-21.5 ft	303.2	829.7	715.1	114.6	411.9	27.8%

All results apply only to actual locations and materials tested. As a mutual protection to clients, the public and ourselves, all reports are submitted as the confidential property of clients, and authorization for publication of statements, conclusions or extracts from or regarding our reports is reserved pending our written approval.

Reviewed by:   
 Meghan Blodgett-Carrillo



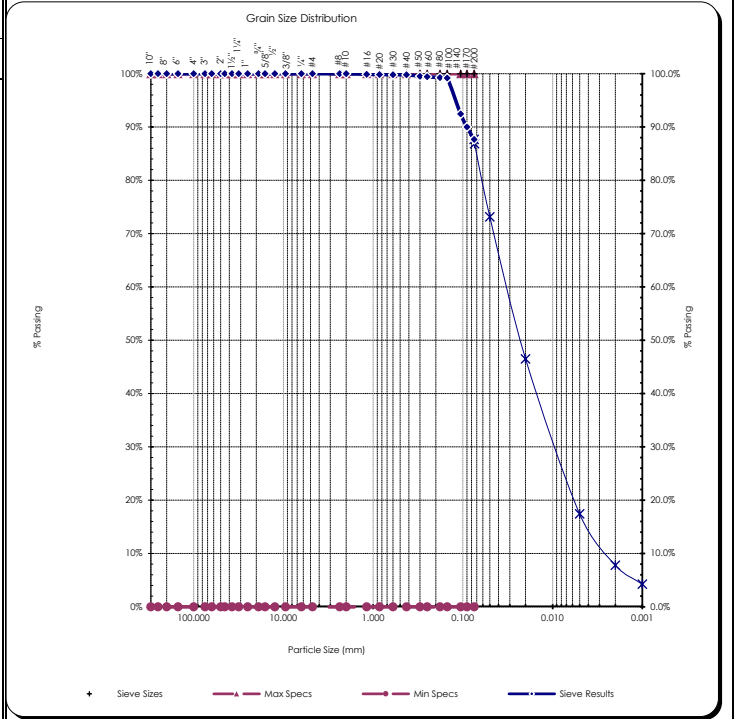
# Sieve Report

<b>Project:</b> Q.C. - Lower Duwamish Waterway <b>Project #:</b> 21B233 <b>Client:</b> Anchor QEA <b>Source:</b> LDW21-GT48-GB-21.6-25 ft <b>Sample#:</b> B21-2143	<b>Date Received:</b> 29-Jul-21 <b>Sampled By:</b> Client <b>Date Tested:</b> 15-Oct-21 <b>Tested By:</b> A. Eifrig	<b>Visual Identification</b> Silt with Sand and Clay <b>Sample Color:</b> brown	 Certificate #: 1366.01
--	--	--	----------------------------

<b>ASTM D2216, ASTM D2419, ASTM D4318, ASTM D5281</b>			
<b>Specifications</b> No Specs <b>Sample Meets Specs ?</b> N/A	D <sub>(5)</sub> = 0.001 mm D <sub>(10)</sub> = 0.003 mm D <sub>(15)</sub> = 0.004 mm D <sub>(30)</sub> = 0.010 mm D <sub>(50)</sub> = 0.023 mm D <sub>(60)</sub> = 0.040 mm D <sub>(90)</sub> = 0.090 mm Dust Ratio = 29/33	% Gravel = 0.0% % Sand = 12.3% % Silt & Clay = 87.7% Liquid Limit = n/a Plasticity Index = n/a Sand Equivalent = n/a Fracture %, 1 Face = n/a Fracture %, 2+ Faces = n/a	Coeff. of Curvature, C <sub>c</sub> = 0.94 Coeff. of Uniformity, C <sub>u</sub> = 14.64 Fineness Modulus = 0.02 Plastic Limit = n/a Moisture %, as sampled = 36.9% Req'd Sand Equivalent = Req'd Fracture %, 1 Face = Req'd Fracture %, 2+ Faces =

**ASTM C136, ASTM D6913, ASTM C117**

Sieve Size		Actual Cumulative Percent Passing	Interpolated Cumulative Percent Passing	Specs Max	Specs Min
US	Metric				
12.00"	300.00		100%	100.0%	0.0%
10.00"	250.00		100%	100.0%	0.0%
8.00"	200.00		100%	100.0%	0.0%
6.00"	150.00		100%	100.0%	0.0%
4.00"	100.00		100%	100.0%	0.0%
3.00"	75.00		100%	100.0%	0.0%
2.50"	63.00		100%	100.0%	0.0%
2.00"	50.00	100%	100%	100.0%	0.0%
1.75"	45.00		100%	100.0%	0.0%
1.50"	37.50		100%	100.0%	0.0%
1.25"	31.50		100%	100.0%	0.0%
1.00"	25.00	100%	100%	100.0%	0.0%
3/4"	19.00	100%	100%	100.0%	0.0%
5/8"	16.00		100%	100.0%	0.0%
1/2"	12.50	100%	100%	100.0%	0.0%
3/8"	9.50	100%	100%	100.0%	0.0%
1/4"	6.30		100%	100.0%	0.0%
#4	4.75	100%	100%	100.0%	0.0%
#8	2.36		100%	100.0%	0.0%
#10	2.00	100%	100%	100.0%	0.0%
#16	1.18		100%	100.0%	0.0%
#20	0.850		100%	100.0%	0.0%
#30	0.600		100%	100.0%	0.0%
#40	0.425	100%	100%	100.0%	0.0%
#50	0.300		100%	100.0%	0.0%
#60	0.250		99%	100.0%	0.0%
#80	0.180		99%	100.0%	0.0%
#100	0.150	99%	99%	100.0%	0.0%
#140	0.106		92%	100.0%	0.0%
#170	0.090		90%	100.0%	0.0%
#200	0.075	87.7%	87.7%	100.0%	0.0%



Copyright Spears Engineering & Technical Services PS, 1996-98  
 All results apply only to actual locations and materials tested. As a mutual protection to clients, the public and ourselves, all reports are submitted as the confidential property of clients, and authorization for publication of statements, conclusions or extracts from or regarding our reports is reserved pending our written approval.

**Comments:** \_\_\_\_\_

Reviewed by:   
 Meghan Blodgett-Carrillo



## Hydrometer Report

<b>Project:</b> Q.C. - Lower Duwamish Waterway <b>Date Received:</b> 29-Jul-21 <b>Project #:</b> 21B233 <b>Sampled By:</b> Client <b>Client :</b> Anchor QEA <b>Date Tested:</b> 15-Oct-21 <b>Source:</b> LDW21-GT48-GB-21.6-25 ft <b>Tested By:</b> A. Eifrig <b>Sample#:</b> B21-2143	<b>Visual Identification</b> Silt with Sand and Clay <b>Sample Color</b> brown																																																																																																																																							
<b>ASTM D7928, HYDROMETER ANALYSIS</b>	<b>ASTM D6913</b>																																																																																																																																							
<table style="width: 100%; border-collapse: collapse;"> <tr> <td style="width: 30%;">Sp. Gr</td> <td style="width: 20%;">2.64</td> <td style="width: 50%;"></td> </tr> <tr> <td>Sample Weight:</td> <td>50.35</td> <td>grams</td> </tr> <tr> <td>Hydroscopic Moist.:</td> <td>2.46%</td> <td></td> </tr> <tr> <td>Adj. Sample Wgt :</td> <td>49.14</td> <td>grams</td> </tr> </table> <table style="width: 100%; border-collapse: collapse;"> <thead> <tr> <th style="text-align: left;">Hydrometer Reading</th> <th style="text-align: left;">Corrected Reading</th> <th style="text-align: left;">Percent Passing</th> <th style="text-align: left;">Soils Particle Diameter</th> </tr> </thead> <tbody> <tr><td>1</td><td>31</td><td>63.7%</td><td>0.0464 mm</td></tr> <tr><td>2</td><td>27.5</td><td>56.5%</td><td>0.0338 mm</td></tr> <tr><td>5</td><td>24</td><td>49.3%</td><td>0.0218 mm</td></tr> <tr><td>15</td><td>17.5</td><td>36.0%</td><td>0.0131 mm</td></tr> <tr><td>30</td><td>14</td><td>28.8%</td><td>0.0095 mm</td></tr> <tr><td>60</td><td>11.5</td><td>23.6%</td><td>0.0068 mm</td></tr> <tr><td>240</td><td>6</td><td>12.3%</td><td>0.0035 mm</td></tr> <tr><td>1440</td><td>3</td><td>6.2%</td><td>0.0015 mm</td></tr> </tbody> </table> <table style="width: 100%; border-collapse: collapse;"> <tr> <td style="width: 30%;">% Gravel:</td> <td style="width: 20%;">0.0%</td> <td style="width: 50%;">Liquid Limit: n/a</td> </tr> <tr> <td>% Sand:</td> <td>12.3%</td> <td>Plastic Limit: n/a</td> </tr> <tr> <td>% Silt:</td> <td>70.2%</td> <td>Plasticity Index: n/a</td> </tr> <tr> <td>% Clay:</td> <td>17.5%</td> <td></td> </tr> </table>	Sp. Gr	2.64		Sample Weight:	50.35	grams	Hydroscopic Moist.:	2.46%		Adj. Sample Wgt :	49.14	grams	Hydrometer Reading	Corrected Reading	Percent Passing	Soils Particle Diameter	1	31	63.7%	0.0464 mm	2	27.5	56.5%	0.0338 mm	5	24	49.3%	0.0218 mm	15	17.5	36.0%	0.0131 mm	30	14	28.8%	0.0095 mm	60	11.5	23.6%	0.0068 mm	240	6	12.3%	0.0035 mm	1440	3	6.2%	0.0015 mm	% Gravel:	0.0%	Liquid Limit: n/a	% Sand:	12.3%	Plastic Limit: n/a	% Silt:	70.2%	Plasticity Index: n/a	% Clay:	17.5%		<table style="width: 100%; border-collapse: collapse;"> <tr> <th colspan="3" style="text-align: center;">Sieve Analysis</th> </tr> <tr> <th colspan="3" style="text-align: center;">Grain Size Distribution</th> </tr> <tr> <th style="text-align: left;">Sieve Size</th> <th style="text-align: left;">Percent Passing</th> <th style="text-align: left;">Soils Particle Diameter</th> </tr> <tr><td>3.0"</td><td>100%</td><td>75.000 mm</td></tr> <tr><td>2.0"</td><td>100%</td><td>50.000 mm</td></tr> <tr><td>1.5"</td><td>100%</td><td>37.500 mm</td></tr> <tr><td>1.25"</td><td>100%</td><td>31.500 mm</td></tr> <tr><td>1.0"</td><td>100%</td><td>25.000 mm</td></tr> <tr><td>3/4"</td><td>100%</td><td>19.000 mm</td></tr> <tr><td>5/8"</td><td>100%</td><td>16.000 mm</td></tr> <tr><td>1/2"</td><td>100%</td><td>12.500 mm</td></tr> <tr><td>3/8"</td><td>100%</td><td>9.500 mm</td></tr> <tr><td>1/4"</td><td>100%</td><td>6.300 mm</td></tr> <tr><td>#4</td><td>100%</td><td>4.750 mm</td></tr> <tr><td>#10</td><td>100%</td><td>2.000 mm</td></tr> <tr><td>#20</td><td>100%</td><td>0.850 mm</td></tr> <tr><td>#40</td><td>100%</td><td>0.425 mm</td></tr> <tr><td>#100</td><td>99%</td><td>0.150 mm</td></tr> <tr><td>#200</td><td>87.7%</td><td>0.075 mm</td></tr> <tr><td style="padding-left: 20px;">Silts</td><td>86.8%</td><td>0.074 mm</td></tr> <tr><td></td><td>73.1%</td><td>0.050 mm</td></tr> <tr><td></td><td>46.5%</td><td>0.020 mm</td></tr> <tr><td style="padding-left: 20px;">Clays</td><td>17.5%</td><td>0.005 mm</td></tr> <tr><td></td><td>7.8%</td><td>0.002 mm</td></tr> <tr><td style="padding-left: 20px;">Colloids</td><td>4.2%</td><td>0.001 mm</td></tr> </table>	Sieve Analysis			Grain Size Distribution			Sieve Size	Percent Passing	Soils Particle Diameter	3.0"	100%	75.000 mm	2.0"	100%	50.000 mm	1.5"	100%	37.500 mm	1.25"	100%	31.500 mm	1.0"	100%	25.000 mm	3/4"	100%	19.000 mm	5/8"	100%	16.000 mm	1/2"	100%	12.500 mm	3/8"	100%	9.500 mm	1/4"	100%	6.300 mm	#4	100%	4.750 mm	#10	100%	2.000 mm	#20	100%	0.850 mm	#40	100%	0.425 mm	#100	99%	0.150 mm	#200	87.7%	0.075 mm	Silts	86.8%	0.074 mm		73.1%	0.050 mm		46.5%	0.020 mm	Clays	17.5%	0.005 mm		7.8%	0.002 mm	Colloids	4.2%	0.001 mm
Sp. Gr	2.64																																																																																																																																							
Sample Weight:	50.35	grams																																																																																																																																						
Hydroscopic Moist.:	2.46%																																																																																																																																							
Adj. Sample Wgt :	49.14	grams																																																																																																																																						
Hydrometer Reading	Corrected Reading	Percent Passing	Soils Particle Diameter																																																																																																																																					
1	31	63.7%	0.0464 mm																																																																																																																																					
2	27.5	56.5%	0.0338 mm																																																																																																																																					
5	24	49.3%	0.0218 mm																																																																																																																																					
15	17.5	36.0%	0.0131 mm																																																																																																																																					
30	14	28.8%	0.0095 mm																																																																																																																																					
60	11.5	23.6%	0.0068 mm																																																																																																																																					
240	6	12.3%	0.0035 mm																																																																																																																																					
1440	3	6.2%	0.0015 mm																																																																																																																																					
% Gravel:	0.0%	Liquid Limit: n/a																																																																																																																																						
% Sand:	12.3%	Plastic Limit: n/a																																																																																																																																						
% Silt:	70.2%	Plasticity Index: n/a																																																																																																																																						
% Clay:	17.5%																																																																																																																																							
Sieve Analysis																																																																																																																																								
Grain Size Distribution																																																																																																																																								
Sieve Size	Percent Passing	Soils Particle Diameter																																																																																																																																						
3.0"	100%	75.000 mm																																																																																																																																						
2.0"	100%	50.000 mm																																																																																																																																						
1.5"	100%	37.500 mm																																																																																																																																						
1.25"	100%	31.500 mm																																																																																																																																						
1.0"	100%	25.000 mm																																																																																																																																						
3/4"	100%	19.000 mm																																																																																																																																						
5/8"	100%	16.000 mm																																																																																																																																						
1/2"	100%	12.500 mm																																																																																																																																						
3/8"	100%	9.500 mm																																																																																																																																						
1/4"	100%	6.300 mm																																																																																																																																						
#4	100%	4.750 mm																																																																																																																																						
#10	100%	2.000 mm																																																																																																																																						
#20	100%	0.850 mm																																																																																																																																						
#40	100%	0.425 mm																																																																																																																																						
#100	99%	0.150 mm																																																																																																																																						
#200	87.7%	0.075 mm																																																																																																																																						
Silts	86.8%	0.074 mm																																																																																																																																						
	73.1%	0.050 mm																																																																																																																																						
	46.5%	0.020 mm																																																																																																																																						
Clays	17.5%	0.005 mm																																																																																																																																						
	7.8%	0.002 mm																																																																																																																																						
Colloids	4.2%	0.001 mm																																																																																																																																						
<b>USDA Soil Textural Classification</b>																																																																																																																																								
<table style="width: 100%; border-collapse: collapse;"> <tr> <td style="width: 30%;"></td> <td style="width: 70%;">Particle Size</td> </tr> <tr> <td>% Sand:</td> <td>2.0 - 0.05 mm</td> </tr> <tr> <td>% Silt:</td> <td>0.05 - 0.002 mm</td> </tr> <tr> <td>% Clay:</td> <td>&lt; 0.002 mm</td> </tr> </table> <p style="text-align: center;"><b>USDA Soil Textural Classification</b> Silt Loam</p>		Particle Size	% Sand:	2.0 - 0.05 mm	% Silt:	0.05 - 0.002 mm	% Clay:	< 0.002 mm																																																																																																																																
	Particle Size																																																																																																																																							
% Sand:	2.0 - 0.05 mm																																																																																																																																							
% Silt:	0.05 - 0.002 mm																																																																																																																																							
% Clay:	< 0.002 mm																																																																																																																																							

All results apply only to actual locations and materials tested. As a mutual protection to clients, the public and ourselves, all reports are submitted as the confidential property of clients, and authorization for publication of statements, conclusions or extracts from or regarding our reports is reserved pending our written approval.

**Comments:** \_\_\_\_\_

\_\_\_\_\_

\_\_\_\_\_

**Reviewed by:** \_\_\_\_\_  
 Meghan Blodgett-Carrillo

## ASTM D4318 - Liquid Limit, Plastic Limit and Plasticity Index of Soils

<b>Project:</b> Q.C. - Lower Duwamish Waterway <b>Project #:</b> 21B233 <b>Client:</b> Anchor QEA <b>Source:</b> LDW21-GT48-GB-21.6-25 ft <b>Sample #:</b> B21-2143	<b>Date Received:</b> 29-Jul-21 <b>Sampled By:</b> Client <b>Date Tested:</b> 15-Oct-21 <b>Tested By:</b> A. Eifrig	<b>Visual Identification</b> Silt with Sand and Clay <b>Sample Color</b> brown				
<b>Liquid Limit Determination</b>						
	#1	#2	#3	#4	#5	#6
<b>Weight of Wet Soils + Pan:</b>	Unable to establish liquid limit					
<b>Weight of Dry Soils + Pan:</b>						
<b>Weight of Pan:</b>						
<b>Weight of Dry Soils:</b>						
<b>Weight of Moisture:</b>						
<b>% Moisture:</b>						
<b>Number of Blows:</b>						
<b>Plastic Limit Determination</b>						
	#1	#2	#3	#4	#5	#6
<b>Weight of Wet Soils + Pan:</b>	Cannot determined plastic limit					
<b>Weight of Dry Soils + Pan:</b>						
<b>Weight of Pan:</b>						
<b>Weight of Dry Soils:</b>						
<b>Weight of Moisture:</b>						
<b>% Moisture:</b>						

**Liquid Limit @ 25 Blows:** N/A  
**Plastic Limit:** N/A  
**Plasticity Index, I<sub>p</sub>:** N/A

**Plasticity Chart**

**Liquid Limit**

Copyright Spears Engineering & Technical Services PS, 1996-98

All results apply only to actual locations and materials tested. As a mutual protection to clients, the public and ourselves, all reports are submitted as the confidential property of clients, and authorization for publication of statements, conclusions or extracts from or regarding our reports is reserved pending our written approval.

**Comments:** Liquid limit cannot be established as the material displays rapid dilation. At lower moistures, the material does not spread into the liquid limit device without tearing the soil cake. Plastic limit cannot be determined as the sample does not roll down to 1/8" threads before cracking or crumbling. Non-plastic.

Reviewed by:   
 \_\_\_\_\_  
 Meghan Blodgett-Carrillo

## ASTM D4318 - Liquid Limit, Plastic Limit and Plasticity Index of Soils

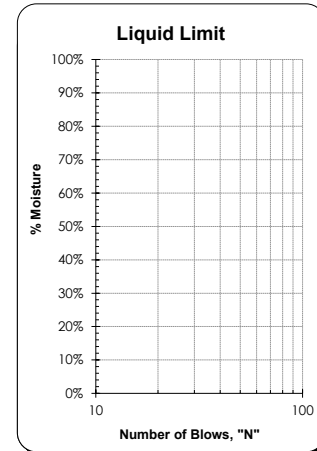
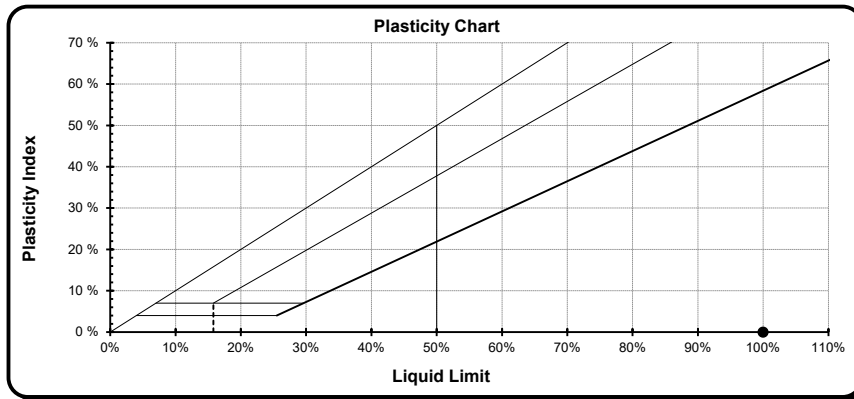
<b>Project:</b> Q.C. - Lower Duwamish Waterway <b>Project #:</b> 21B233 <b>Client:</b> Anchor QEA <b>Source:</b> LDW21-GT48-GB-25-30 ft <b>Sample #:</b> B21-2144	<b>Date Received:</b> 29-Jul-21 <b>Sampled By:</b> Client <b>Date Tested:</b> 15-Oct-21 <b>Tested By:</b> A. Eifrig	<b>Visual Identification</b> Silt with Sand and Clay <b>Sample Color</b> brown
---	--	---

Liquid Limit Determination						
	#1	#2	#3	#4	#5	#6
Weight of Wet Soils + Pan:	Unable to establish liquid limit					
Weight of Dry Soils + Pan:						
Weight of Pan:						
Weight of Dry Soils:						
Weight of Moisture:						
% Moisture:						
Number of Blows:						



**Liquid Limit @ 25 Blows:** N/A  
**Plastic Limit:** N/A  
**Plasticity Index, I<sub>p</sub>:** N/A

Plastic Limit Determination						
	#1	#2	#3	#4	#5	#6
Weight of Wet Soils + Pan:	Cannot determined plastic limit					
Weight of Dry Soils + Pan:						
Weight of Pan:						
Weight of Dry Soils:						
Weight of Moisture:						
% Moisture:						



Copyright Spears Engineering & Technical Services PS, 1996-98

All results apply only to actual locations and materials tested. As a mutual protection to clients, the public and ourselves, all reports are submitted as the confidential property of clients, and authorization for publication of statements, conclusions or extracts from or regarding our reports is reserved pending our written approval.

**Comments:** Liquid limit cannot be established as the material displays rapid dilation. At lower moistures, the material does not spread into the liquid limit device without tearing the soil cake. Plastic limit cannot be determined as the sample does not roll down to 1/8" threads before cracking or crumbling. Non-plastic.

Reviewed by:   
 Meghan Blodgett-Carrillo

# Materials Testing & Consulting, Inc.

Geotechnical Engineering • Special Inspections • Materials Testing • Environmental Consulting



## ASTM D4318 - Liquid Limit, Plastic Limit and Plasticity Index of Soils

<b>Project:</b> Q.C. - Lower Duwamish Waterway <b>Project #:</b> 21B233 <b>Client:</b> Anchor QEA, LLC <b>Source:</b> LDW21-GT48-GB-30-35 ft <b>Sample #:</b> B21-2145	<b>Date Received:</b> 29-Jul-21 <b>Sampled By:</b> Client <b>Date Tested:</b> 18-Oct-21 <b>Tested By:</b> C. Kirk-Patterson	<b>Visual Identification</b> Silt with Clay <b>Sample Color</b> brown
--	--	--

Liquid Limit Determination						
	#1	#2	#3	#4	#5	#6
Weight of Wet Soils + Pan:	29.11	30.59	34.12			
Weight of Dry Soils + Pan:	25.96	26.90	30.59			
Weight of Pan:	15.19	14.77	19.81			
Weight of Dry Soils:	10.77	12.13	10.78			
Weight of Moisture:	3.15	3.69	3.53			
% Moisture:	29.3 %	30.4 %	32.8 %			
Number of Blows:	30	23	18			

Plastic Limit Determination						
	#1	#2	#3	#4	#5	#6
Weight of Wet Soils + Pan:	34.58	35.80				
Weight of Dry Soils + Pan:	33.37	34.35				
Weight of Pan:	28.28	28.60				
Weight of Dry Soils:	5.09	5.75				
Weight of Moisture:	1.21	1.45				
% Moisture:	23.8 %	25.2 %				

**Liquid Limit @ 25 Blows:** 30 %

**Plastic Limit:** 24 %

**Plasticity Index, I<sub>p</sub>:** 6 %

Copyright Spears Engineering & Technical Services PS, 1996-98  
 All results apply only to actual locations and materials tested. As a mutual protection to clients, the public and ourselves, all reports are submitted as the confidential property of clients, and authorization for publication of statements, conclusions or extracts from or regarding our reports is reserved pending our written approval.

**Comments:** \_\_\_\_\_

Reviewed by:   
 Meghan Blodgett-Carrillo

## ASTM D4318 - Liquid Limit, Plastic Limit and Plasticity Index of Soils

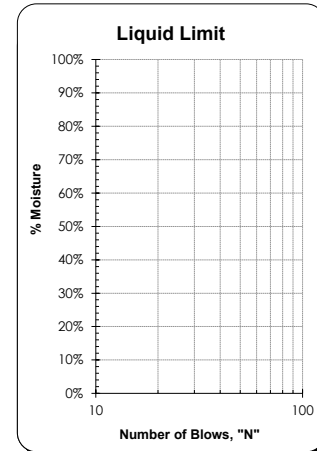
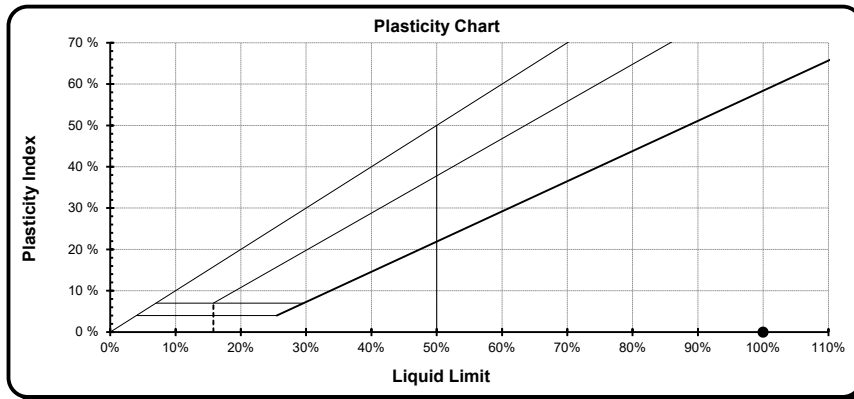
<b>Project:</b> Q.C. - Lower Duwamish Waterway <b>Project #:</b> 21B233 <b>Client:</b> Anchor QEA <b>Source:</b> LDW21-GT53-GB-0-5 ft <b>Sample #:</b> B21-2148	<b>Date Received:</b> 29-Jul-21 <b>Sampled By:</b> Client <b>Date Tested:</b> 15-Oct-21 <b>Tested By:</b> A. Eifrig	<b>Visual Identification</b> Silt with Clay <b>Sample Color</b> brown
---	--	--

Liquid Limit Determination						
	#1	#2	#3	#4	#5	#6
Weight of Wet Soils + Pan:	Unable to establish liquid limit					
Weight of Dry Soils + Pan:						
Weight of Pan:						
Weight of Dry Soils:						
Weight of Moisture:						
% Moisture:						
Number of Blows:						



**Liquid Limit @ 25 Blows:** N/A  
**Plastic Limit:** N/A  
**Plasticity Index, I<sub>p</sub>:** N/A

Plastic Limit Determination						
	#1	#2	#3	#4	#5	#6
Weight of Wet Soils + Pan:	Cannot determined plastic limit					
Weight of Dry Soils + Pan:						
Weight of Pan:						
Weight of Dry Soils:						
Weight of Moisture:						
% Moisture:						



Copyright Spears Engineering & Technical Services PS, 1996-98

All results apply only to actual locations and materials tested. As a mutual protection to clients, the public and ourselves, all reports are submitted as the confidential property of clients, and authorization for publication of statements, conclusions or extracts from or regarding our reports is reserved pending our written approval.

**Comments:** Liquid limit cannot be established as the material displays rapid dilation. At lower moistures, the material does not spread into the liquid limit device without tearing the soil cake. Plastic limit cannot be determined as the sample does not roll down to 1/8" threads before cracking or crumbling. Non-plastic.

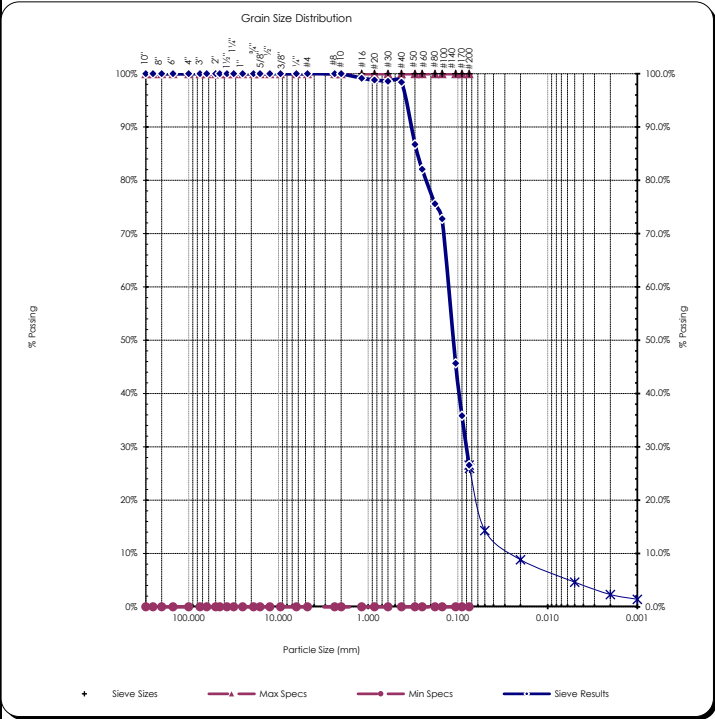
Reviewed by:   
 Meghan Blodgett-Carrillo

# Sieve Report

<b>Project:</b> Q.C. - Lower Duwamish Waterway <b>Project #:</b> 21B233 <b>Client:</b> Anchor QEA <b>Source:</b> LDW21-GT53-GB-5-10 ft <b>Sample#:</b> B21-2150	<b>Date Received:</b> 29-Jul-21 <b>Sampled By:</b> Client <b>Date Tested:</b> 15-Oct-21 <b>Tested By:</b> A. Eifrig	<b>Unified Soil Classification System, ASTM-2487</b> SM, Silty Sand <b>Sample Color:</b> brown	 <b>ACCREDITED</b> Certificate #: 1366.01
---	--	---	---

<b>ASTM D2216, ASTM D2419, ASTM D4318, ASTM D5281</b>			
<b>Specifications</b> No Specs <b>Sample Meets Specs ?</b> N/A	D <sub>(5)</sub> = 0.005 mm D <sub>(10)</sub> = 0.028 mm D <sub>(15)</sub> = 0.056 mm D <sub>(30)</sub> = 0.081 mm D <sub>(50)</sub> = 0.113 mm D <sub>(60)</sub> = 0.129 mm D <sub>(90)</sub> = 0.335 mm Dust Ratio = 10/37	% Gravel = 0.0% % Sand = 73.4% % Silt & Clay = 26.6% Liquid Limit = n/a Plasticity Index = n/a Sand Equivalent = n/a Fracture %, 1 Face = n/a Fracture %, 2+ Faces = n/a	Coeff. of Curvature, C <sub>c</sub> = 1.81 Coeff. of Uniformity, C <sub>u</sub> = 4.67 Fineness Modulus = 0.43 Plastic Limit = n/a Moisture %, as sampled = 45.6% Req'd Sand Equivalent = Req'd Fracture %, 1 Face = Req'd Fracture %, 2+ Faces =

<b>ASTM C136, ASTM D6913, ASTM C117</b>					
Sieve Size		Actual Cumulative Percent Passing	Interpolated Cumulative Percent Passing	Specs Max	Specs Min
US	Metric				
12.00"	300.00		100%	100.0%	0.0%
10.00"	250.00		100%	100.0%	0.0%
8.00"	200.00		100%	100.0%	0.0%
6.00"	150.00		100%	100.0%	0.0%
4.00"	100.00		100%	100.0%	0.0%
3.00"	75.00		100%	100.0%	0.0%
2.50"	63.00		100%	100.0%	0.0%
2.00"	50.00	100%	100%	100.0%	0.0%
1.75"	45.00	100%	100%	100.0%	0.0%
1.50"	37.50	100%	100%	100.0%	0.0%
1.25"	31.50	100%	100%	100.0%	0.0%
1.00"	25.00	100%	100%	100.0%	0.0%
3/4"	19.00	100%	100%	100.0%	0.0%
5/8"	16.00	100%	100%	100.0%	0.0%
1/2"	12.50	100%	100%	100.0%	0.0%
3/8"	9.50	100%	100%	100.0%	0.0%
1/4"	6.30	100%	100%	100.0%	0.0%
#4	4.75	100%	100%	100.0%	0.0%
#8	2.36	100%	100%	100.0%	0.0%
#10	2.00	100%	100%	100.0%	0.0%
#16	1.18	99%	99%	100.0%	0.0%
#20	0.850	99%	99%	100.0%	0.0%
#30	0.600	99%	99%	100.0%	0.0%
#40	0.425	98%	98%	100.0%	0.0%
#50	0.300	87%	87%	100.0%	0.0%
#60	0.250	82%	82%	100.0%	0.0%
#80	0.180	76%	76%	100.0%	0.0%
#100	0.150	73%	73%	100.0%	0.0%
#140	0.106	46%	46%	100.0%	0.0%
#170	0.090	36%	36%	100.0%	0.0%
#200	0.075	26.6%	26.6%	100.0%	0.0%




Copyright Spears Engineering & Technical Services PS, 1996-98  
 All results apply only to actual locations and materials tested. As a mutual protection to clients, the public and ourselves, all reports are submitted as the confidential property of clients, and authorization for publication of statements, conclusions or extracts from or regarding our reports is reserved pending our written approval.

**Comments:** \_\_\_\_\_

Reviewed by:   
 Meghan Blodgett-Carrillo



# Hydrometer Report

<b>Project:</b> Q.C. - Lower Duwamish Waterway <b>Project #:</b> 21B233 <b>Client:</b> Anchor QEA <b>Source:</b> LDW21-GT53-GB-5-10 ft <b>Sample#:</b> B21-2150		<b>Date Received:</b> 29-Jul-21 <b>Sampled By:</b> Client <b>Date Tested:</b> 15-Oct-21 <b>Tested By:</b> A. Eifrig		<b>Unified Soil Classification System, ASTM-2487</b> SM, Silty Sand <b>Sample Color</b> brown																																																																																																																		
<b>ASTM D7928, HYDROMETER ANALYSIS</b>				<b>ASTM D6913</b>																																																																																																																		
<b>Assumed Sp. Gr</b> 2.65 <b>Sample Weight:</b> 100.03 grams <b>Hydroscopic Moist.:</b> 2.23% <b>Adj. Sample Wgt :</b> 97.85 grams				<b>Sieve Analysis</b> <b>Grain Size Distribution</b>																																																																																																																		
<table border="1"> <thead> <tr> <th>Hydrometer Reading Minutes</th> <th>Corrected Reading</th> <th>Percent Passing</th> <th>Soils Particle Diameter</th> </tr> </thead> <tbody> <tr><td>1</td><td>12</td><td>12.3%</td><td>0.0516 mm</td></tr> <tr><td>2</td><td>11.5</td><td>11.8%</td><td>0.0368 mm</td></tr> <tr><td>5</td><td>9</td><td>9.2%</td><td>0.0235 mm</td></tr> <tr><td>15</td><td>8</td><td>8.2%</td><td>0.0137 mm</td></tr> <tr><td>30</td><td>7</td><td>7.2%</td><td>0.0097 mm</td></tr> <tr><td>60</td><td>6.5</td><td>6.6%</td><td>0.0069 mm</td></tr> <tr><td>240</td><td>3</td><td>3.1%</td><td>0.0035 mm</td></tr> <tr><td>1440</td><td>2</td><td>2.0%</td><td>0.0014 mm</td></tr> </tbody> </table>		Hydrometer Reading Minutes	Corrected Reading	Percent Passing	Soils Particle Diameter	1	12	12.3%	0.0516 mm	2	11.5	11.8%	0.0368 mm	5	9	9.2%	0.0235 mm	15	8	8.2%	0.0137 mm	30	7	7.2%	0.0097 mm	60	6.5	6.6%	0.0069 mm	240	3	3.1%	0.0035 mm	1440	2	2.0%	0.0014 mm	<table border="1"> <thead> <tr> <th>Sieve Size</th> <th>Percent Passing</th> <th>Soils Particle Diameter</th> </tr> </thead> <tbody> <tr><td>3.0"</td><td>100%</td><td>75.000 mm</td></tr> <tr><td>2.0"</td><td>100%</td><td>50.000 mm</td></tr> <tr><td>1.5"</td><td>100%</td><td>37.500 mm</td></tr> <tr><td>1.25"</td><td>100%</td><td>31.500 mm</td></tr> <tr><td>1.0"</td><td>100%</td><td>25.000 mm</td></tr> <tr><td>3/4"</td><td>100%</td><td>19.000 mm</td></tr> <tr><td>5/8"</td><td>100%</td><td>16.000 mm</td></tr> <tr><td>1/2"</td><td>100%</td><td>12.500 mm</td></tr> <tr><td>3/8"</td><td>100%</td><td>9.500 mm</td></tr> <tr><td>1/4"</td><td>100%</td><td>6.300 mm</td></tr> <tr><td>#4</td><td>100%</td><td>4.750 mm</td></tr> <tr><td>#10</td><td>100%</td><td>2.000 mm</td></tr> <tr><td>#20</td><td>99%</td><td>0.850 mm</td></tr> <tr><td>#40</td><td>98%</td><td>0.425 mm</td></tr> <tr><td>#100</td><td>73%</td><td>0.150 mm</td></tr> <tr><td>#200</td><td>26.6%</td><td>0.075 mm</td></tr> <tr><td><b>Silts</b></td><td>26.0%</td><td>0.074 mm</td></tr> <tr><td></td><td>14.3%</td><td>0.050 mm</td></tr> <tr><td></td><td>8.8%</td><td>0.020 mm</td></tr> <tr><td><b>Clays</b></td><td>4.6%</td><td>0.005 mm</td></tr> <tr><td></td><td>2.3%</td><td>0.002 mm</td></tr> <tr><td><b>Colloids</b></td><td>1.4%</td><td>0.001 mm</td></tr> </tbody> </table>		Sieve Size	Percent Passing	Soils Particle Diameter	3.0"	100%	75.000 mm	2.0"	100%	50.000 mm	1.5"	100%	37.500 mm	1.25"	100%	31.500 mm	1.0"	100%	25.000 mm	3/4"	100%	19.000 mm	5/8"	100%	16.000 mm	1/2"	100%	12.500 mm	3/8"	100%	9.500 mm	1/4"	100%	6.300 mm	#4	100%	4.750 mm	#10	100%	2.000 mm	#20	99%	0.850 mm	#40	98%	0.425 mm	#100	73%	0.150 mm	#200	26.6%	0.075 mm	<b>Silts</b>	26.0%	0.074 mm		14.3%	0.050 mm		8.8%	0.020 mm	<b>Clays</b>	4.6%	0.005 mm		2.3%	0.002 mm	<b>Colloids</b>	1.4%	0.001 mm	<table border="1"> <thead> <tr> <th></th> <th>Particle Size</th> </tr> </thead> <tbody> <tr><td>% Sand:</td><td>2.0 - 0.05 mm</td></tr> <tr><td>% Silt:</td><td>0.05 - 0.002 mm</td></tr> <tr><td>% Clay:</td><td>&lt; 0.002 mm</td></tr> </tbody> </table> <p style="text-align: center;"><b>USDA Soil Textural Classification</b> Loamy Sand</p>			Particle Size	% Sand:	2.0 - 0.05 mm	% Silt:	0.05 - 0.002 mm	% Clay:	< 0.002 mm
Hydrometer Reading Minutes	Corrected Reading	Percent Passing	Soils Particle Diameter																																																																																																																			
1	12	12.3%	0.0516 mm																																																																																																																			
2	11.5	11.8%	0.0368 mm																																																																																																																			
5	9	9.2%	0.0235 mm																																																																																																																			
15	8	8.2%	0.0137 mm																																																																																																																			
30	7	7.2%	0.0097 mm																																																																																																																			
60	6.5	6.6%	0.0069 mm																																																																																																																			
240	3	3.1%	0.0035 mm																																																																																																																			
1440	2	2.0%	0.0014 mm																																																																																																																			
Sieve Size	Percent Passing	Soils Particle Diameter																																																																																																																				
3.0"	100%	75.000 mm																																																																																																																				
2.0"	100%	50.000 mm																																																																																																																				
1.5"	100%	37.500 mm																																																																																																																				
1.25"	100%	31.500 mm																																																																																																																				
1.0"	100%	25.000 mm																																																																																																																				
3/4"	100%	19.000 mm																																																																																																																				
5/8"	100%	16.000 mm																																																																																																																				
1/2"	100%	12.500 mm																																																																																																																				
3/8"	100%	9.500 mm																																																																																																																				
1/4"	100%	6.300 mm																																																																																																																				
#4	100%	4.750 mm																																																																																																																				
#10	100%	2.000 mm																																																																																																																				
#20	99%	0.850 mm																																																																																																																				
#40	98%	0.425 mm																																																																																																																				
#100	73%	0.150 mm																																																																																																																				
#200	26.6%	0.075 mm																																																																																																																				
<b>Silts</b>	26.0%	0.074 mm																																																																																																																				
	14.3%	0.050 mm																																																																																																																				
	8.8%	0.020 mm																																																																																																																				
<b>Clays</b>	4.6%	0.005 mm																																																																																																																				
	2.3%	0.002 mm																																																																																																																				
<b>Colloids</b>	1.4%	0.001 mm																																																																																																																				
	Particle Size																																																																																																																					
% Sand:	2.0 - 0.05 mm																																																																																																																					
% Silt:	0.05 - 0.002 mm																																																																																																																					
% Clay:	< 0.002 mm																																																																																																																					

All results apply only to actual locations and materials tested. As a mutual protection to clients, the public and ourselves, all reports are submitted as the confidential property of clients, and authorization for publication of statements, conclusions or extracts from or regarding our reports is reserved pending our written approval.

**Comments:** \_\_\_\_\_

**Reviewed by:** Meghan Blodgett-Carrillo  


# Direct Shear Test Results:

ASTM D-3080



Project: Q.C. - Lower Duwamish Waterway  
 Project Number: 21B233  
 Laboratory Sample ID: B21-2150  
 Sample Date: 8/5/2021  
 Test Date: 10/18/2021  
 Technician: M. Carrillo

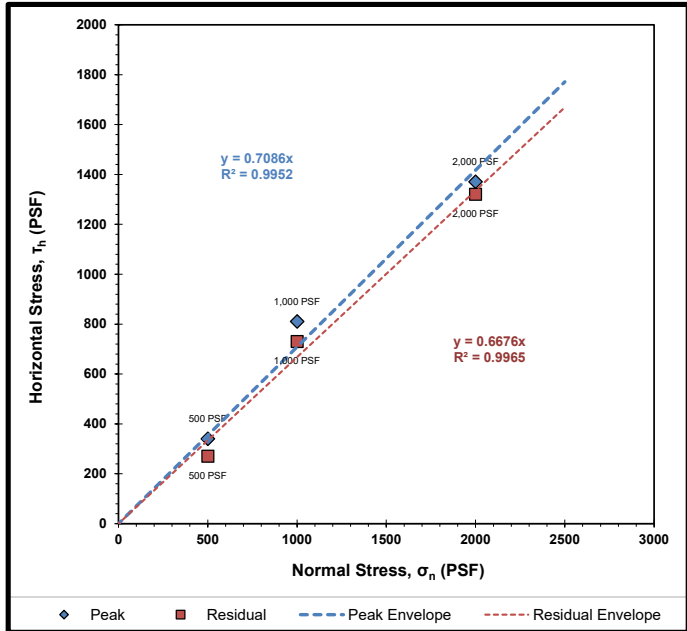
Sample Source: LDW21-GT53-GB-5-10 ft  
 Visual Soil Description: brown silty sand with gravel  
 Type of Specimen: Remolded Cylindrical Shear Box  
 Specimen Diameter (in): 2.5  
 Specimen Height (in): 1  
 Rate of Strain (in/min): 0.0208  
 Estimated Specific Gravity of Solids: 2.65

Summary of Sample Data: $\sigma_n=500$ PSF		
Initial Moisture Content (%):	30.0	
	Initial	Post-Consolidation
Dry Density (PCF):	109.7	110.6
Void Ratio:	0.536	0.523
Porosity (%):	34.9	34.3
Degree of Saturation (%):	saturated	saturated

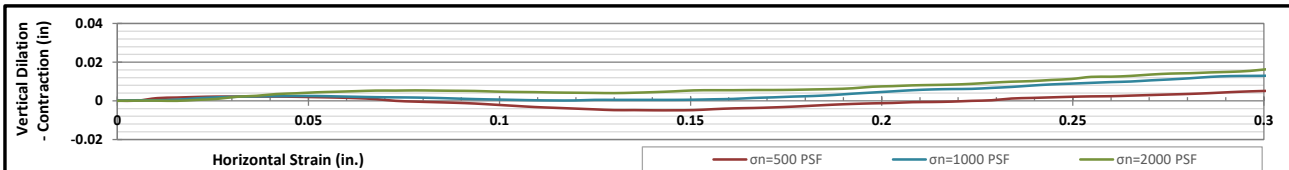
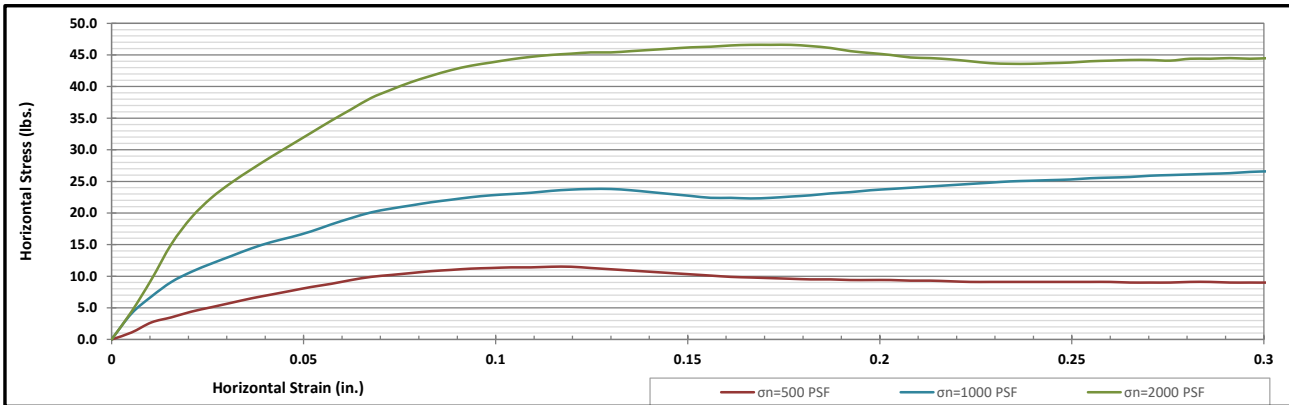
Summary of Sample Data: $\sigma_n=1000$ PSF		
Initial Moisture Content (%):	29.9	
	Initial	Post-Consolidation
Dry Density (PCF):	110.2	112.7
Void Ratio:	0.529	0.495
Porosity (%):	34.6	33.1
Degree of Saturation (%):	saturated	saturated

Summary of Sample Data: $\sigma_n=2000$ PSF		
Initial Moisture Content (%):	29.3	
	Initial	Post-Consolidation
Dry Density (PCF):	110.5	114.2
Void Ratio:	0.524	0.475
Porosity (%):	34.4	32.2
Degree of Saturation (%):	saturated	saturated

ESTIMATED STRENGTH PARAMETERS		
	PEAK	RESIDUAL
Angle of Internal Friction, $\phi$ (°):	35	34
Cohesion (PSF):	0	0



Failure Envelope Test Values:			
Normal Stress, $\sigma_n$ (PSF):	500	1000	2000
Peak Horizontal Stress, $\tau_h$ (PSF):	340	810	1370
Residual Horizontal Stress, $\tau_r$ (PSF):	270	730	1320



Corporate • 777 Chrysler Drive • Burlington, WA 98233 • Phone 360.755.1990 • Fax 360.755.1980  
 SW Region • 2118 Black Lake Blvd. S.W. • Olympia, WA 98512 • Phone 360.534.9777 • Fax 360.534.9779  
 NW Region • 805 Dupont, Suite #5 • Bellingham, WA 98225 • Phone 360.647.6061 • Fax 360.647.8111  
 Kitsap Region • 5451 N.W. Newberry Hill Road, Suite 101 • Silverdale, WA 98383 • Phone/Fax 360.698.6787

Visit our website: [www.mtc-inc.net](http://www.mtc-inc.net)



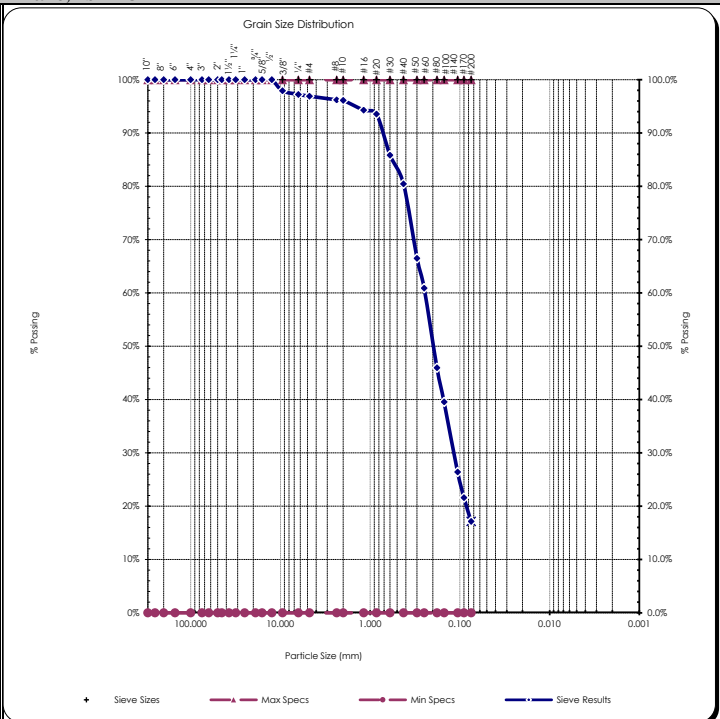


# Sieve Report

<b>Project:</b> Q.C. - Lower Duwamish Waterway <b>Project #:</b> 21B233 <b>Client:</b> Anchor QEA <b>Source:</b> LDW21-GT53-GB-10-15 ft <b>Sample#:</b> B21-2151	<b>Date Received:</b> 29-Jul-21 <b>Sampled By:</b> Client <b>Date Tested:</b> 15-Oct-21 <b>Tested By:</b> A. Eifrig	<b>Unified Soil Classification System, ASTM-2487</b> SM, Silty Sand <b>Sample Color:</b> brown	ACCREDITED Certificate #: 1366.01
--	--	---	--------------------------------------

<b>ASTM D2216, ASTM D2419, ASTM D4318, ASTM D5281</b>			
<b>Specifications</b> No Specs <b>Sample Meets Specs ? N/A</b>	D <sub>(5)</sub> = 0.022 mm D <sub>(10)</sub> = 0.044 mm D <sub>(15)</sub> = 0.066 mm D <sub>(30)</sub> = 0.118 mm D <sub>(50)</sub> = 0.199 mm D <sub>(60)</sub> = 0.246 mm D <sub>(90)</sub> = 0.735 mm Dust Ratio = 13/61	% Gravel = 3.1% % Sand = 79.8% % Silt & Clay = 17.1% Liquid Limit = n/a Plasticity Index = n/a Sand Equivalent = n/a Fracture %, 1 Face = n/a Fracture %, 2+ Faces = n/a	Coeff. of Curvature, C <sub>c</sub> = 1.30 Coeff. of Uniformity, C <sub>u</sub> = 5.62 Fineness Modulus = 1.23 Plastic Limit = n/a Moisture %, as sampled = 64.8% Req'd Sand Equivalent = Req'd Fracture %, 1 Face = Req'd Fracture %, 2+ Faces =

<b>ASTM C136, ASTM D6913, ASTM C117</b>					
<b>Sieve Size</b>		<b>Actual Cumulative Percent Passing</b>	<b>Interpolated Cumulative Percent Passing</b>	<b>Specs Max</b>	<b>Specs Min</b>
<b>US</b>	<b>Metric</b>				
12.00"	300.00		100%	100.0%	0.0%
10.00"	250.00		100%	100.0%	0.0%
8.00"	200.00		100%	100.0%	0.0%
6.00"	150.00		100%	100.0%	0.0%
4.00"	100.00		100%	100.0%	0.0%
3.00"	75.00		100%	100.0%	0.0%
2.50"	63.00		100%	100.0%	0.0%
2.00"	50.00	100%	100%	100.0%	0.0%
1.75"	45.00	100%	100%	100.0%	0.0%
1.50"	37.50	100%	100%	100.0%	0.0%
1.25"	31.50	100%	100%	100.0%	0.0%
1.00"	25.00	100%	100%	100.0%	0.0%
3/4"	19.00	100%	100%	100.0%	0.0%
5/8"	16.00	100%	100%	100.0%	0.0%
1/2"	12.50	100%	100%	100.0%	0.0%
3/8"	9.50	98%	98%	100.0%	0.0%
1/4"	6.30	97%	97%	100.0%	0.0%
#4	4.75	97%	97%	100.0%	0.0%
#8	2.36	96%	96%	100.0%	0.0%
#10	2.00	96%	96%	100.0%	0.0%
#16	1.18	94%	94%	100.0%	0.0%
#20	0.850	94%	94%	100.0%	0.0%
#30	0.600	86%	86%	100.0%	0.0%
#40	0.425	80%	80%	100.0%	0.0%
#50	0.300	66%	66%	100.0%	0.0%
#60	0.250	61%	61%	100.0%	0.0%
#80	0.180	46%	46%	100.0%	0.0%
#100	0.150	40%	40%	100.0%	0.0%
#140	0.106	26%	26%	100.0%	0.0%
#170	0.090	22%	22%	100.0%	0.0%
#200	0.075	17.1%	17.1%	100.0%	0.0%



Copyright Spears Engineering & Technical Services PS, 1996-98  
 All results apply only to actual locations and materials tested. As a mutual protection to clients, the public and ourselves, all reports are submitted as the confidential property of clients, and authorization for publication of statements, conclusions or extracts from or regarding our reports is reserved pending our written approval.

**Comments:** \_\_\_\_\_

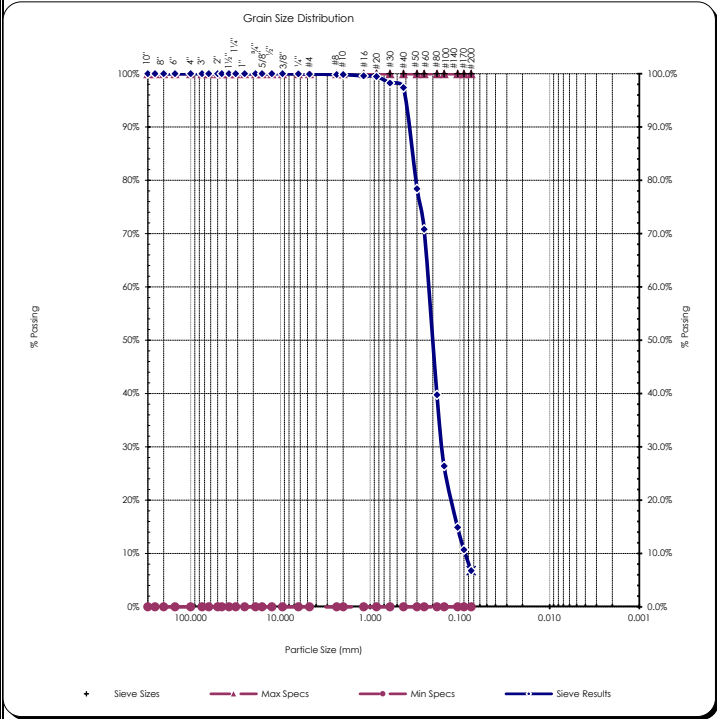
Reviewed by:   
 Meghan Blodgett-Carrillo

# Sieve Report

<b>Project:</b> Q.C. - Lower Duwamish Waterway <b>Project #:</b> 21B233 <b>Client:</b> Anchor QEA <b>Source:</b> LDW21-GT53-GB-15-20 ft <b>Sample#:</b> B21-2152	<b>Date Received:</b> 29-Jul-21 <b>Sampled By:</b> Client <b>Date Tested:</b> 15-Oct-21 <b>Tested By:</b> A. Eifrig	<b>Unified Soil Classification System, ASTM-2487</b> SP-SM, Poorly graded Sand with Silt <b>Sample Color:</b> brown	 <b>ACCREDITED</b> Certificate #: 1366.01
--	--	--	---

<b>ASTM D2216, ASTM D2419, ASTM D4318, ASTM D5281</b>			
<b>Specifications</b> No Specs <b>Sample Meets Specs ? N/A</b>	$D_{(5)} = 0.055$ mm $D_{(10)} = 0.087$ mm $D_{(15)} = 0.106$ mm $D_{(30)} = 0.158$ mm $D_{(50)} = 0.203$ mm $D_{(60)} = 0.226$ mm $D_{(90)} = 0.376$ mm Dust Ratio = 3/43	% Gravel = 0.1% % Sand = 93.2% % Silt & Clay = 6.8% Liquid Limit = n/a Plasticity Index = n/a Sand Equivalent = n/a Fracture %, 1 Face = n/a Fracture %, 2+ Faces = n/a	Coeff. of Curvature, $C_c = 1.27$ Coeff. of Uniformity, $C_u = 2.59$ Fineness Modulus = 0.98 Plastic Limit = n/a Moisture %, as sampled = 27.7% Req'd Sand Equivalent = Req'd Fracture %, 1 Face = Req'd Fracture %, 2+ Faces =

<b>ASTM C136, ASTM D6913, ASTM C117</b>					
Sieve Size		Actual Cumulative Percent Passing	Interpolated Cumulative Percent Passing	Specs Max	Specs Min
US	Metric				
12.00"	300.00		100%	100.0%	0.0%
10.00"	250.00		100%	100.0%	0.0%
8.00"	200.00		100%	100.0%	0.0%
6.00"	150.00		100%	100.0%	0.0%
4.00"	100.00		100%	100.0%	0.0%
3.00"	75.00		100%	100.0%	0.0%
2.50"	63.00		100%	100.0%	0.0%
2.00"	50.00	100%	100%	100.0%	0.0%
1.75"	45.00	100%	100%	100.0%	0.0%
1.50"	37.50	100%	100%	100.0%	0.0%
1.25"	31.50	100%	100%	100.0%	0.0%
1.00"	25.00	100%	100%	100.0%	0.0%
3/4"	19.00	100%	100%	100.0%	0.0%
5/8"	16.00	100%	100%	100.0%	0.0%
1/2"	12.50	100%	100%	100.0%	0.0%
3/8"	9.50	100%	100%	100.0%	0.0%
1/4"	6.30	100%	100%	100.0%	0.0%
#4	4.75	100%	100%	100.0%	0.0%
#8	2.36	100%	100%	100.0%	0.0%
#10	2.00	100%	100%	100.0%	0.0%
#16	1.18	100%	100%	100.0%	0.0%
#20	0.850	99%	99%	100.0%	0.0%
#30	0.600	98%	98%	100.0%	0.0%
#40	0.425	97%	97%	100.0%	0.0%
#50	0.300	78%	78%	100.0%	0.0%
#60	0.250	71%	71%	100.0%	0.0%
#80	0.180	40%	40%	100.0%	0.0%
#100	0.150	26%	26%	100.0%	0.0%
#140	0.106	15%	15%	100.0%	0.0%
#170	0.090	11%	11%	100.0%	0.0%
#200	0.075	6.8%	6.8%	100.0%	0.0%



Copyright Spears Engineering & Technical Services PS, 1996-98  
 All results apply only to actual locations and materials tested. As a mutual protection to clients, the public and ourselves, all reports are submitted as the confidential property of clients, and authorization for publication of statements, conclusions or extracts from or regarding our reports is reserved pending our written approval.

**Comments:** \_\_\_\_\_

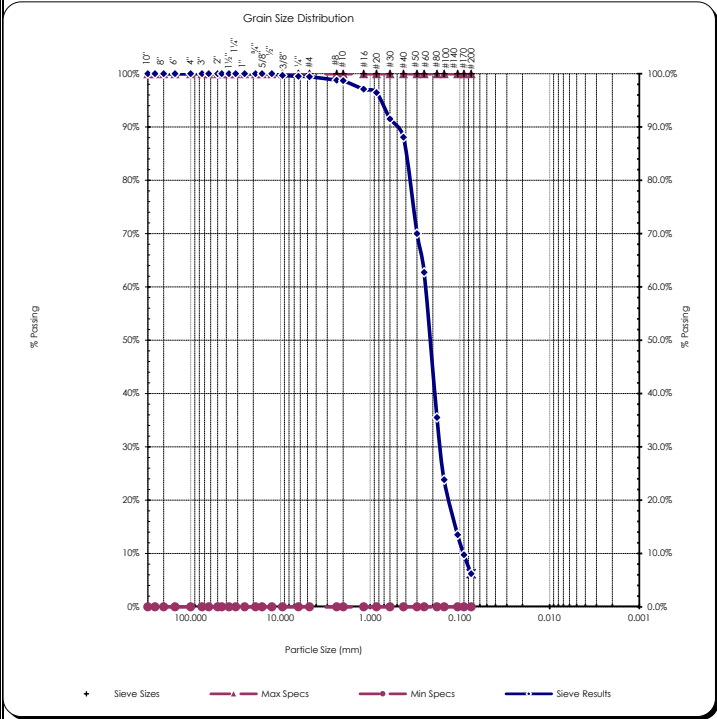
Reviewed by:   
 Meghan Blodgett-Carrillo

# Sieve Report

<b>Project:</b> Q.C. - Lower Duwamish Waterway <b>Project #:</b> 21B233 <b>Client:</b> Anchor QEA <b>Source:</b> LDW21-GT53-GB-20-23.5 ft <b>Sample#:</b> B21-2153	<b>Date Received:</b> 29-Jul-21 <b>Sampled By:</b> Client <b>Date Tested:</b> 15-Oct-21 <b>Tested By:</b> A. Eifrig	<b>Unified Soil Classification System, ASTM-2487</b> SP-SM, Poorly graded Sand with Silt <b>Sample Color:</b> brown	 Certificate #: 1366.01
--	--	--	----------------------------

<b>ASTM D2216, ASTM D2419, ASTM D4318, ASTM D5281</b>			
<b>Specifications</b> No Specs <b>Sample Meets Specs ?</b> N/A	D <sub>(5)</sub> = 0.060 mm D <sub>(10)</sub> = 0.091 mm D <sub>(15)</sub> = 0.112 mm D <sub>(30)</sub> = 0.166 mm D <sub>(50)</sub> = 0.217 mm D <sub>(60)</sub> = 0.243 mm D <sub>(90)</sub> = 0.522 mm Dust Ratio = 7/99	% Gravel = 0.6% % Sand = 93.2% % Silt & Clay = 6.2% Liquid Limit = n/a Plasticity Index = n/a Sand Equivalent = n/a Fracture %, 1 Face = n/a Fracture %, 2+ Faces = n/a	Coeff. of Curvature, C <sub>c</sub> = 1.24 Coeff. of Uniformity, C <sub>u</sub> = 2.67 Fineness Modulus = 1.20 Plastic Limit = n/a Moisture %, as sampled = 29.9% Req'd Sand Equivalent = Req'd Fracture %, 1 Face = Req'd Fracture %, 2+ Faces =

<b>ASTM C136, ASTM D6913, ASTM C117</b>					
Sieve Size		Actual Cumulative Percent Passing	Interpolated Cumulative Percent Passing	Specs Max	Specs Min
US	Metric				
12.00"	300.00		100%	100.0%	0.0%
10.00"	250.00		100%	100.0%	0.0%
8.00"	200.00		100%	100.0%	0.0%
6.00"	150.00		100%	100.0%	0.0%
4.00"	100.00		100%	100.0%	0.0%
3.00"	75.00		100%	100.0%	0.0%
2.50"	63.00		100%	100.0%	0.0%
2.00"	50.00	100%	100%	100.0%	0.0%
1.75"	45.00	100%	100%	100.0%	0.0%
1.50"	37.50	100%	100%	100.0%	0.0%
1.25"	31.50	100%	100%	100.0%	0.0%
1.00"	25.00	100%	100%	100.0%	0.0%
3/4"	19.00	100%	100%	100.0%	0.0%
5/8"	16.00	100%	100%	100.0%	0.0%
1/2"	12.50	100%	100%	100.0%	0.0%
3/8"	9.50	100%	100%	100.0%	0.0%
1/4"	6.30	100%	100%	100.0%	0.0%
#4	4.75	99%	99%	100.0%	0.0%
#8	2.36	99%	99%	100.0%	0.0%
#10	2.00	99%	99%	100.0%	0.0%
#16	1.18	97%	97%	100.0%	0.0%
#20	0.850	96%	96%	100.0%	0.0%
#30	0.600	92%	92%	100.0%	0.0%
#40	0.425	88%	88%	100.0%	0.0%
#50	0.300	70%	70%	100.0%	0.0%
#60	0.250	63%	63%	100.0%	0.0%
#80	0.180	36%	36%	100.0%	0.0%
#100	0.150	24%	24%	100.0%	0.0%
#140	0.106	14%	14%	100.0%	0.0%
#170	0.090	10%	10%	100.0%	0.0%
#200	0.075	6.2%	6.2%	100.0%	0.0%



Copyright Spears Engineering & Technical Services PS, 1996-98

All results apply only to actual locations and materials tested. As a mutual protection to clients, the public and ourselves, all reports are submitted as the confidential property of clients, and authorization for publication of statements, conclusions or extracts from or regarding our reports is reserved pending our written approval.

**Comments:** \_\_\_\_\_

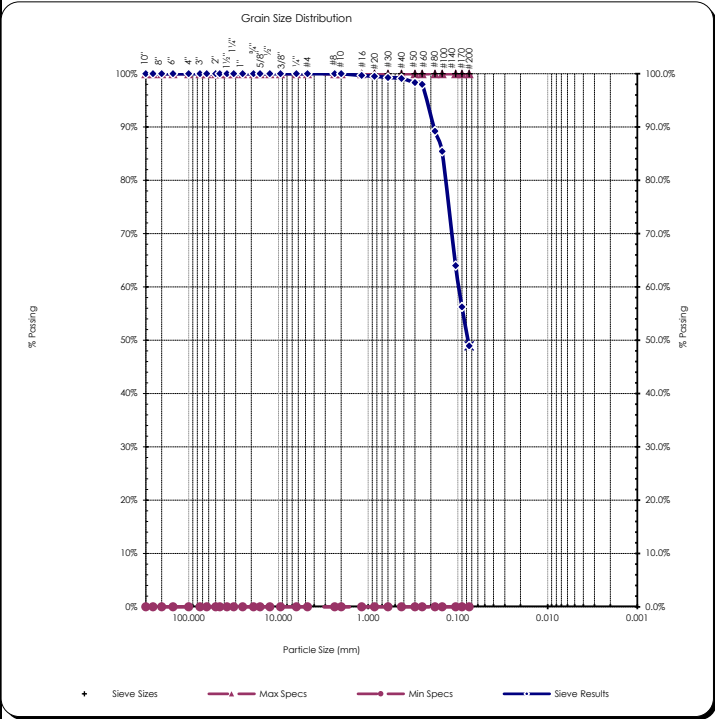
Reviewed by:   
 Meghan Blodgett-Carrillo

# Sieve Report

<b>Project:</b> Q.C. - Lower Duwamish Waterway <b>Project #:</b> 21B233 <b>Client:</b> Anchor QEA <b>Source:</b> LDW21-GT53-GB-23.5-25 ft <b>Sample#:</b> B21-2154	<b>Date Received:</b> 29-Jul-21 <b>Sampled By:</b> Client <b>Date Tested:</b> 15-Oct-21 <b>Tested By:</b> A. Eifrig	<b>Unified Soil Classification System, ASTM-2487</b> SM, Silty Sand <b>Sample Color:</b> brown	 <b>ACCREDITED</b> Certificate #: 1366.01
--	--	---	---

<b>ASTM D2216, ASTM D2419, ASTM D4318, ASTM D5281</b>			
<b>Specifications</b> No Specs <b>Sample Meets Specs ?</b> N/A	D <sub>(5)</sub> = 0.008 mm D <sub>(10)</sub> = 0.015 mm D <sub>(15)</sub> = 0.023 mm D <sub>(30)</sub> = 0.046 mm D <sub>(50)</sub> = 0.077 mm D <sub>(60)</sub> = 0.098 mm D <sub>(90)</sub> = 0.186 mm Dust Ratio = 39/79	% Gravel = 0.0% % Sand = 51.1% % Silt & Clay = 48.9% Liquid Limit = n/a Plasticity Index = n/a Sand Equivalent = n/a Fracture %, 1 Face = n/a Fracture %, 2+ Faces = n/a	Coeff. of Curvature, C <sub>c</sub> = 1.41 Coeff. of Uniformity, C <sub>u</sub> = 6.38 Fineness Modulus = 0.17 Plastic Limit = n/a Moisture %, as sampled = 33.7% Req'd Sand Equivalent = Req'd Fracture %, 1 Face = Req'd Fracture %, 2+ Faces =

<b>ASTM C136, ASTM D6913, ASTM C117</b>					
Sieve Size		Actual Cumulative Percent Passing	Interpolated Cumulative Percent Passing	Specs Max	Specs Min
US	Metric				
12.00"	300.00		100%	100.0%	0.0%
10.00"	250.00		100%	100.0%	0.0%
8.00"	200.00		100%	100.0%	0.0%
6.00"	150.00		100%	100.0%	0.0%
4.00"	100.00		100%	100.0%	0.0%
3.00"	75.00		100%	100.0%	0.0%
2.50"	63.00		100%	100.0%	0.0%
2.00"	50.00	100%	100%	100.0%	0.0%
1.75"	45.00		100%	100.0%	0.0%
1.50"	37.50		100%	100.0%	0.0%
1.25"	31.50		100%	100.0%	0.0%
1.00"	25.00	100%	100%	100.0%	0.0%
3/4"	19.00	100%	100%	100.0%	0.0%
5/8"	16.00		100%	100.0%	0.0%
1/2"	12.50	100%	100%	100.0%	0.0%
3/8"	9.50	100%	100%	100.0%	0.0%
1/4"	6.30		100%	100.0%	0.0%
#4	4.75	100%	100%	100.0%	0.0%
#8	2.36		100%	100.0%	0.0%
#10	2.00	100%	100%	100.0%	0.0%
#16	1.18		100%	100.0%	0.0%
#20	0.850	100%	100%	100.0%	0.0%
#30	0.600		99%	100.0%	0.0%
#40	0.425	99%	99%	100.0%	0.0%
#50	0.300		98%	100.0%	0.0%
#60	0.250	98%	98%	100.0%	0.0%
#80	0.180		89%	100.0%	0.0%
#100	0.150	85%	85%	100.0%	0.0%
#140	0.106		64%	100.0%	0.0%
#170	0.090		56%	100.0%	0.0%
#200	0.075	48.9%	48.9%	100.0%	0.0%



Copyright Spears Engineering & Technical Services PS, 1996-98

All results apply only to actual locations and materials tested. As a mutual protection to clients, the public and ourselves, all reports are submitted as the confidential property of clients, and authorization for publication of statements, conclusions or extracts from or regarding our reports is reserved pending our written approval.

**Comments:** \_\_\_\_\_

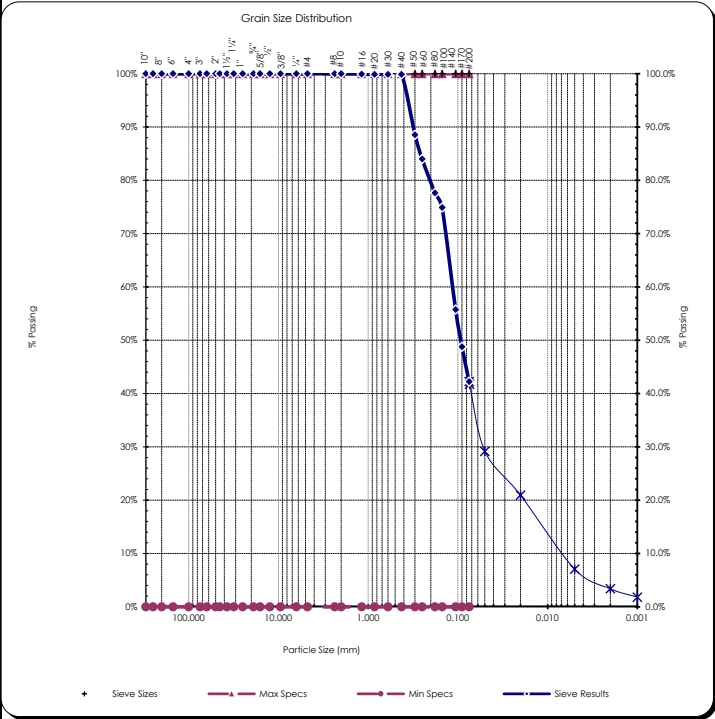
Reviewed by:   
 Meghan Blodgett-Carrillo

# Sieve Report

<b>Project:</b> Q.C. - Lower Duwamish Waterway <b>Project #:</b> 21B233 <b>Client:</b> Anchor QEA <b>Source:</b> LDW21-GT53-GB-25-28.6 ft <b>Sample#:</b> B21-2155	<b>Date Received:</b> 29-Jul-21 <b>Sampled By:</b> Client <b>Date Tested:</b> 15-Oct-21 <b>Tested By:</b> A. Eifrig	<b>Unified Soil Classification System, ASTM-2487</b> SM, Silty Sand <b>Sample Color:</b> brown	 <b>ACCREDITED</b> Certificate #: 1366.01
--	--	---	---

<b>ASTM D2216, ASTM D2419, ASTM D4318, ASTM D5281</b>			
<b>Specifications</b> No Specs <b>Sample Meets Specs ?</b> N/A	D <sub>(5)</sub> = 0.003 mm D <sub>(10)</sub> = 0.008 mm D <sub>(15)</sub> = 0.013 mm D <sub>(30)</sub> = 0.049 mm D <sub>(50)</sub> = 0.093 mm D <sub>(60)</sub> = 0.116 mm D <sub>(90)</sub> = 0.316 mm Dust Ratio = 11/26	% Gravel = 0.0% % Sand = 57.7% % Silt & Clay = 42.3% Liquid Limit = n/a Plasticity Index = n/a Sand Equivalent = n/a Fracture %, 1 Face = n/a Fracture %, 2+ Faces = n/a	Coeff. of Curvature, C <sub>c</sub> = 2.78 Coeff. of Uniformity, C <sub>u</sub> = 15.33 Fineness Modulus = 0.37 Plastic Limit = n/a Moisture %, as sampled = 34.9% Req'd Sand Equivalent = Req'd Fracture %, 1 Face = Req'd Fracture %, 2+ Faces =

<b>ASTM C136, ASTM D6913, ASTM C117</b>					
<b>Sieve Size</b>		<b>Actual Cumulative Percent Passing</b>	<b>Interpolated Cumulative Percent Passing</b>	<b>Specs Max</b>	<b>Specs Min</b>
<b>US</b>	<b>Metric</b>				
12.00"	300.00		100%	100.0%	0.0%
10.00"	250.00		100%	100.0%	0.0%
8.00"	200.00		100%	100.0%	0.0%
6.00"	150.00		100%	100.0%	0.0%
4.00"	100.00		100%	100.0%	0.0%
3.00"	75.00		100%	100.0%	0.0%
2.50"	63.00		100%	100.0%	0.0%
2.00"	50.00	100%	100%	100.0%	0.0%
1.75"	45.00	100%	100%	100.0%	0.0%
1.50"	37.50	100%	100%	100.0%	0.0%
1.25"	31.50	100%	100%	100.0%	0.0%
1.00"	25.00	100%	100%	100.0%	0.0%
3/4"	19.00	100%	100%	100.0%	0.0%
5/8"	16.00	100%	100%	100.0%	0.0%
1/2"	12.50	100%	100%	100.0%	0.0%
3/8"	9.50	100%	100%	100.0%	0.0%
1/4"	6.30	100%	100%	100.0%	0.0%
#4	4.75	100%	100%	100.0%	0.0%
#8	2.36	100%	100%	100.0%	0.0%
#10	2.00	100%	100%	100.0%	0.0%
#16	1.18	100%	100%	100.0%	0.0%
#20	0.850	100%	100%	100.0%	0.0%
#30	0.600	100%	100%	100.0%	0.0%
#40	0.425	100%	100%	100.0%	0.0%
#50	0.300	89%	89%	100.0%	0.0%
#60	0.250	84%	84%	100.0%	0.0%
#80	0.180	78%	78%	100.0%	0.0%
#100	0.150	75%	75%	100.0%	0.0%
#140	0.106	56%	56%	100.0%	0.0%
#170	0.090	49%	49%	100.0%	0.0%
#200	0.075	42.3%	42.3%	100.0%	0.0%



Copyright Spears Engineering & Technical Services PS, 1996-98  
 All results apply only to actual locations and materials tested. As a mutual protection to clients, the public and ourselves, all reports are submitted as the confidential property of clients, and authorization for publication of statements, conclusions or extracts from or regarding our reports is reserved pending our written approval.

**Comments:** \_\_\_\_\_

Reviewed by:   
 Meghan Blodgett-Carrillo

## Hydrometer Report

<b>Project:</b> Q.C. - Lower Duwamish Waterway <b>Project #:</b> 21B233 <b>Client:</b> Anchor QEA <b>Source:</b> LDW21-GT53-GB-25-28.6 ft <b>Sample#:</b> B21-2155	<b>Date Received:</b> 29-Jul-21 <b>Sampled By:</b> Client <b>Date Tested:</b> 15-Oct-21 <b>Tested By:</b> A. Eifrig	<b>Unified Soil Classification System, ASTM-2487</b> SM, Silty Sand <b>Sample Color</b> brown																																																																																																												
<b>ASTM D7928, HYDROMETER ANALYSIS</b>		<b>ASTM D6913</b>																																																																																																												
Sp. Gr: 2.48 Sample Weight: 75.36 grams Hydroscopic Moist.: 0.35% Adj. Sample Wgt: 75.10 grams																																																																																																														
<table border="1" style="width: 100%; border-collapse: collapse;"> <thead> <tr> <th>Hydrometer Reading Minutes</th> <th>Corrected Reading</th> <th>Percent Passing</th> <th>Soils Particle Diameter</th> </tr> </thead> <tbody> <tr><td>1</td><td>22</td><td>30.8%</td><td>0.0519 mm</td></tr> <tr><td>2</td><td>19</td><td>26.6%</td><td>0.0374 mm</td></tr> <tr><td>5</td><td>17</td><td>23.8%</td><td>0.0239 mm</td></tr> <tr><td>15</td><td>12</td><td>16.8%</td><td>0.0142 mm</td></tr> <tr><td>30</td><td>9</td><td>12.6%</td><td>0.0102 mm</td></tr> <tr><td>60</td><td>7</td><td>9.8%</td><td>0.0073 mm</td></tr> <tr><td>240</td><td>4</td><td>5.6%</td><td>0.0037 mm</td></tr> <tr><td>1440</td><td>2</td><td>2.8%</td><td>0.0015 mm</td></tr> </tbody> </table>		Hydrometer Reading Minutes	Corrected Reading	Percent Passing	Soils Particle Diameter	1	22	30.8%	0.0519 mm	2	19	26.6%	0.0374 mm	5	17	23.8%	0.0239 mm	15	12	16.8%	0.0142 mm	30	9	12.6%	0.0102 mm	60	7	9.8%	0.0073 mm	240	4	5.6%	0.0037 mm	1440	2	2.8%	0.0015 mm	<table border="1" style="width: 100%; border-collapse: collapse;"> <thead> <tr> <th>Sieve Size</th> <th>Percent Passing</th> <th>Soils Particle Diameter</th> </tr> </thead> <tbody> <tr><td>3.0"</td><td>100%</td><td>75.000 mm</td></tr> <tr><td>2.0"</td><td>100%</td><td>50.000 mm</td></tr> <tr><td>1.5"</td><td>100%</td><td>37.500 mm</td></tr> <tr><td>1.25"</td><td>100%</td><td>31.500 mm</td></tr> <tr><td>1.0"</td><td>100%</td><td>25.000 mm</td></tr> <tr><td>3/4"</td><td>100%</td><td>19.000 mm</td></tr> <tr><td>5/8"</td><td>100%</td><td>16.000 mm</td></tr> <tr><td>1/2"</td><td>100%</td><td>12.500 mm</td></tr> <tr><td>3/8"</td><td>100%</td><td>9.500 mm</td></tr> <tr><td>1/4"</td><td>100%</td><td>6.300 mm</td></tr> <tr><td>#4</td><td>100%</td><td>4.750 mm</td></tr> <tr><td>#10</td><td>100%</td><td>2.000 mm</td></tr> <tr><td>#20</td><td>100%</td><td>0.850 mm</td></tr> <tr><td>#40</td><td>100%</td><td>0.425 mm</td></tr> <tr><td>#100</td><td>75%</td><td>0.150 mm</td></tr> <tr><td>#200</td><td>42.3%</td><td>0.075 mm</td></tr> <tr><td colspan="2"><b>Silts</b></td><td>41.8%</td></tr> <tr><td colspan="2"></td><td>29.2%</td></tr> <tr><td colspan="2"></td><td>20.9%</td></tr> <tr><td colspan="2"><b>Clays</b></td><td>7.1%</td></tr> <tr><td colspan="2"></td><td>3.4%</td></tr> <tr><td colspan="2"><b>Colloids</b></td><td>1.8%</td></tr> <tr><td colspan="2"></td><td>0.001 mm</td></tr> </tbody> </table>	Sieve Size	Percent Passing	Soils Particle Diameter	3.0"	100%	75.000 mm	2.0"	100%	50.000 mm	1.5"	100%	37.500 mm	1.25"	100%	31.500 mm	1.0"	100%	25.000 mm	3/4"	100%	19.000 mm	5/8"	100%	16.000 mm	1/2"	100%	12.500 mm	3/8"	100%	9.500 mm	1/4"	100%	6.300 mm	#4	100%	4.750 mm	#10	100%	2.000 mm	#20	100%	0.850 mm	#40	100%	0.425 mm	#100	75%	0.150 mm	#200	42.3%	0.075 mm	<b>Silts</b>		41.8%			29.2%			20.9%	<b>Clays</b>		7.1%			3.4%	<b>Colloids</b>		1.8%			0.001 mm
Hydrometer Reading Minutes	Corrected Reading	Percent Passing	Soils Particle Diameter																																																																																																											
1	22	30.8%	0.0519 mm																																																																																																											
2	19	26.6%	0.0374 mm																																																																																																											
5	17	23.8%	0.0239 mm																																																																																																											
15	12	16.8%	0.0142 mm																																																																																																											
30	9	12.6%	0.0102 mm																																																																																																											
60	7	9.8%	0.0073 mm																																																																																																											
240	4	5.6%	0.0037 mm																																																																																																											
1440	2	2.8%	0.0015 mm																																																																																																											
Sieve Size	Percent Passing	Soils Particle Diameter																																																																																																												
3.0"	100%	75.000 mm																																																																																																												
2.0"	100%	50.000 mm																																																																																																												
1.5"	100%	37.500 mm																																																																																																												
1.25"	100%	31.500 mm																																																																																																												
1.0"	100%	25.000 mm																																																																																																												
3/4"	100%	19.000 mm																																																																																																												
5/8"	100%	16.000 mm																																																																																																												
1/2"	100%	12.500 mm																																																																																																												
3/8"	100%	9.500 mm																																																																																																												
1/4"	100%	6.300 mm																																																																																																												
#4	100%	4.750 mm																																																																																																												
#10	100%	2.000 mm																																																																																																												
#20	100%	0.850 mm																																																																																																												
#40	100%	0.425 mm																																																																																																												
#100	75%	0.150 mm																																																																																																												
#200	42.3%	0.075 mm																																																																																																												
<b>Silts</b>		41.8%																																																																																																												
		29.2%																																																																																																												
		20.9%																																																																																																												
<b>Clays</b>		7.1%																																																																																																												
		3.4%																																																																																																												
<b>Colloids</b>		1.8%																																																																																																												
		0.001 mm																																																																																																												
<b>USDA Soil Textural Classification</b>																																																																																																														
<table border="1" style="width: 100%; border-collapse: collapse;"> <thead> <tr> <th></th> <th>Particle Size</th> </tr> </thead> <tbody> <tr><td>% Sand:</td><td>2.0 - 0.05 mm</td></tr> <tr><td>% Silt:</td><td>0.05 - 0.002 mm</td></tr> <tr><td>% Clay:</td><td>&lt; 0.002 mm</td></tr> </tbody> </table>			Particle Size	% Sand:	2.0 - 0.05 mm	% Silt:	0.05 - 0.002 mm	% Clay:	< 0.002 mm																																																																																																					
	Particle Size																																																																																																													
% Sand:	2.0 - 0.05 mm																																																																																																													
% Silt:	0.05 - 0.002 mm																																																																																																													
% Clay:	< 0.002 mm																																																																																																													
<b>USDA Soil Textural Classification</b>																																																																																																														
Sandy Loam																																																																																																														

All results apply only to actual locations and materials tested. As a mutual protection to clients, the public and ourselves, all reports are submitted as the confidential property of clients, and authorization for publication of statements, conclusions or extracts from or regarding our reports is reserved pending our written approval.

**Comments:** \_\_\_\_\_

\_\_\_\_\_

\_\_\_\_\_

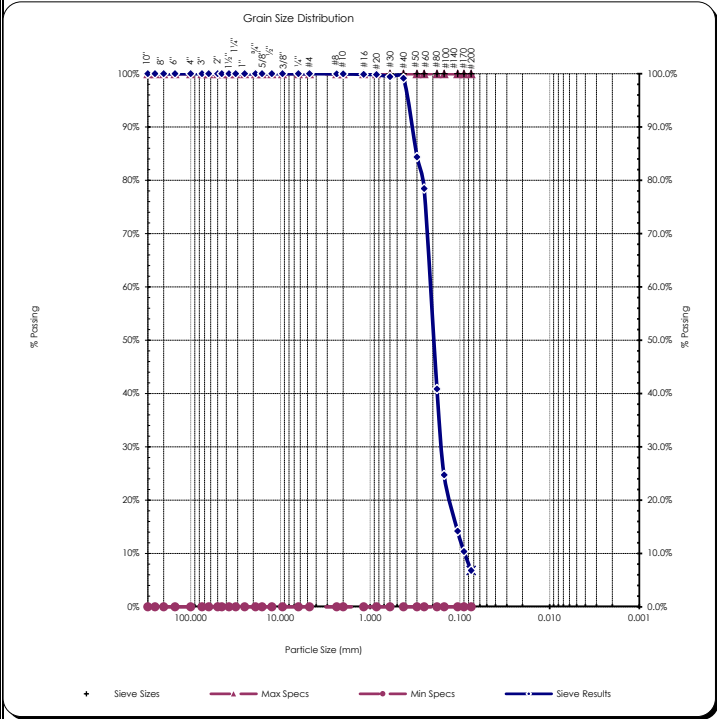
**Reviewed by:** \_\_\_\_\_  
 Meghan Blodgett-Carrillo

# Sieve Report

<b>Project:</b> Q.C. - Lower Duwamish Waterway <b>Project #:</b> 21B233 <b>Client:</b> Anchor QEA <b>Source:</b> LDW21-GT53-GB-28.6-30 ft <b>Sample#:</b> B21-2156	<b>Date Received:</b> 29-Jul-21 <b>Sampled By:</b> Client <b>Date Tested:</b> 15-Oct-21 <b>Tested By:</b> A. Eifrig	<b>Unified Soil Classification System, ASTM-2487</b> SP-SM, Poorly graded Sand with Silt <b>Sample Color:</b> grayish-brown	 <b>ACCREDITED</b> Certificate #: 1366.01
--	--	--	---

<b>ASTM D2216, ASTM D2419, ASTM D4318, ASTM D5281</b>			
<b>Specifications</b> No Specs <b>Sample Meets Specs ?</b> N/A	D <sub>(5)</sub> = 0.055 mm D <sub>(10)</sub> = 0.088 mm D <sub>(15)</sub> = 0.109 mm D <sub>(30)</sub> = 0.160 mm D <sub>(50)</sub> = 0.197 mm D <sub>(60)</sub> = 0.216 mm D <sub>(90)</sub> = 0.348 mm Dust Ratio = 2/29	% Gravel = 0.0% % Sand = 93.2% % Silt & Clay = 6.8% Liquid Limit = n/a Plasticity Index = n/a Sand Equivalent = n/a Fracture %, 1 Face = n/a Fracture %, 2+ Faces = n/a	Coeff. of Curvature, C <sub>c</sub> = 1.34 Coeff. of Uniformity, C <sub>u</sub> = 2.44 Fineness Modulus = 0.92 Plastic Limit = n/a Moisture %, as sampled = 22.4% Req'd Sand Equivalent = Req'd Fracture %, 1 Face = Req'd Fracture %, 2+ Faces =

<b>ASTM C136, ASTM D6913, ASTM C117</b>					
Sieve Size		Actual Cumulative Percent Passing	Interpolated Cumulative Percent Passing	Specs Max	Specs Min
US	Metric				
12.00"	300.00		100%	100.0%	0.0%
10.00"	250.00		100%	100.0%	0.0%
8.00"	200.00		100%	100.0%	0.0%
6.00"	150.00		100%	100.0%	0.0%
4.00"	100.00		100%	100.0%	0.0%
3.00"	75.00		100%	100.0%	0.0%
2.50"	63.00		100%	100.0%	0.0%
2.00"	50.00	100%	100%	100.0%	0.0%
1.75"	45.00	100%	100%	100.0%	0.0%
1.50"	37.50	100%	100%	100.0%	0.0%
1.25"	31.50	100%	100%	100.0%	0.0%
1.00"	25.00	100%	100%	100.0%	0.0%
3/4"	19.00	100%	100%	100.0%	0.0%
5/8"	16.00	100%	100%	100.0%	0.0%
1/2"	12.50	100%	100%	100.0%	0.0%
3/8"	9.50	100%	100%	100.0%	0.0%
1/4"	6.30	100%	100%	100.0%	0.0%
#4	4.75	100%	100%	100.0%	0.0%
#8	2.36	100%	100%	100.0%	0.0%
#10	2.00	100%	100%	100.0%	0.0%
#16	1.18	100%	100%	100.0%	0.0%
#20	0.850	100%	100%	100.0%	0.0%
#30	0.600	99%	99%	100.0%	0.0%
#40	0.425	99%	99%	100.0%	0.0%
#50	0.300	84%	84%	100.0%	0.0%
#60	0.250	78%	78%	100.0%	0.0%
#80	0.180	41%	41%	100.0%	0.0%
#100	0.150	25%	25%	100.0%	0.0%
#140	0.106	14%	14%	100.0%	0.0%
#170	0.090	10%	10%	100.0%	0.0%
#200	0.075	6.8%	6.8%	100.0%	0.0%



Copyright Spears Engineering & Technical Services PS, 1996-98  
 All results apply only to actual locations and materials tested. As a mutual protection to clients, the public and ourselves, all reports are submitted as the confidential property of clients, and authorization for publication of statements, conclusions or extracts from or regarding our reports is reserved pending our written approval.

**Comments:** \_\_\_\_\_

Reviewed by:   
 Meghan Blodgett-Carrillo



**Client:** Anchor QEA  
**Address:** 21328 2nd Drive SE  
Bothell, WA 98021  
**Attn:** Garrett Timm  
**Revised on:** \_\_\_\_\_

**Date:** October 25, 2021  
**Project:** Q.C. - Lower Duwamish Waterway  
**Project #:** 21B233  
**Sample #:** B21-2164-2174  
**Date sampled:** 8-3-21 & 8-5-21

As requested MTC, Inc. has performed the following test(s) on the sample referenced above. The testing was performed in accordance with current applicable AASHTO or ASTM standards as indicated below. The results obtained in our laboratory were as follows below or on the attached pages:

	Test(s) Performed:	Test Results		Test(s) Performed:	Test Results
X	Sieve Analysis	Please See Attached Reports		Sulfate Soundness	
	Proctor			Bulk Density & Voids	
	Sand Equivalent			WSDOT Degradation	
	Fracture Count			LA Abrasion	
X	Moisture Content	Please See Attached Report	X	Direct Shear	Please See Attached Reports
	Specific Gravity, Coarse		X	Specific Gravity, Soils	Please See Attached Reports
	Specific Gravity, Fine				
X	Hydrometer Analysis	Please See Attached Reports			
X	Atterberg Limits	Please See Attached Reports			

If you have any questions concerning the test results, the procedures used, or if we can be of any further assistance please call on us at the number below.

Respectfully Submitted,  
 Meghan Blodgett-Carrillo  
 WABO Supervising Laboratory Technician





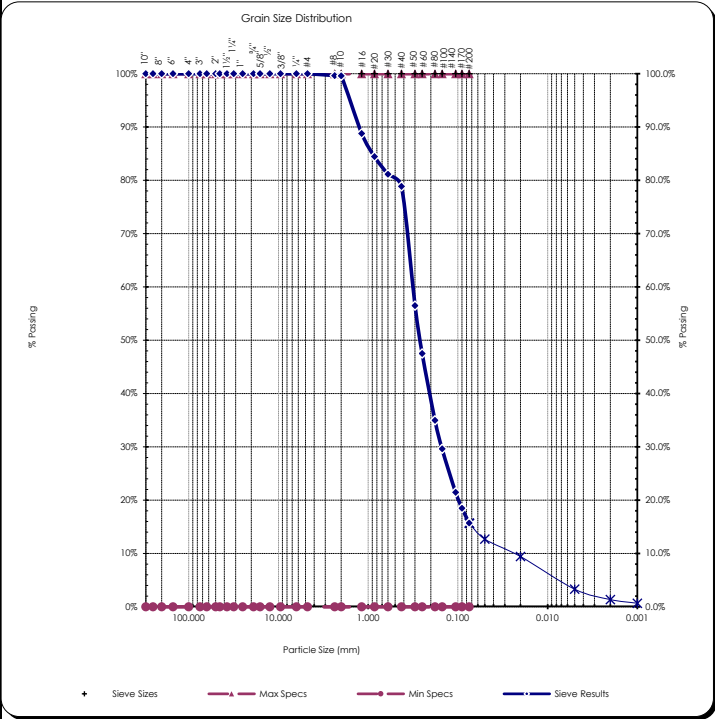


# Sieve Report

<b>Project:</b> Q.C. - Lower Duwamish Waterway <b>Project #:</b> 21B233 <b>Client:</b> Anchor QEA <b>Source:</b> LDW21-GT41-GH-0-1.3 ft <b>Sample#:</b> B21-2170	<b>Date Received:</b> 29-Jul-21 <b>Sampled By:</b> Client <b>Date Tested:</b> 18-Oct-21 <b>Tested By:</b> A. Eifrig	<b>Unified Soil Classification System, ASTM-2487</b> SM, Silty Sand <b>Sample Color:</b> brown	 Certificate #: 1366.01
--	--	---	----------------------------

<b>ASTM D2216, ASTM D2419, ASTM D4318, ASTM D5281</b>			
<b>Specifications</b> No Specs <b>Sample Meets Specs ?</b> N/A	D <sub>(5)</sub> = 0.008 mm D <sub>(10)</sub> = 0.022 mm D <sub>(15)</sub> = 0.068 mm D <sub>(30)</sub> = 0.152 mm D <sub>(50)</sub> = 0.264 mm D <sub>(60)</sub> = 0.320 mm D <sub>(90)</sub> = 1.271 mm Dust Ratio = 1/5	% Gravel = 0.0% % Sand = 84.3% % Silt & Clay = 15.7% Liquid Limit = n/a Plasticity Index = n/a Sand Equivalent = n/a Fracture %, 1 Face = n/a Fracture %, 2+ Faces = n/a	Coeff. of Curvature, C <sub>c</sub> = 3.31 Coeff. of Uniformity, C <sub>u</sub> = 14.63 Fineness Modulus = 1.44 Plastic Limit = n/a Moisture %, as sampled = 29.8% Req'd Sand Equivalent = Req'd Fracture %, 1 Face = Req'd Fracture %, 2+ Faces =

<b>ASTM C136, ASTM D6913, ASTM C117</b>					
Sieve Size		Actual Cumulative Percent Passing	Interpolated Cumulative Percent Passing	Specs Max	Specs Min
US	Metric				
12.00"	300.00		100%	100.0%	0.0%
10.00"	250.00		100%	100.0%	0.0%
8.00"	200.00		100%	100.0%	0.0%
6.00"	150.00		100%	100.0%	0.0%
4.00"	100.00		100%	100.0%	0.0%
3.00"	75.00		100%	100.0%	0.0%
2.50"	63.00		100%	100.0%	0.0%
2.00"	50.00	100%	100%	100.0%	0.0%
1.75"	45.00	100%	100%	100.0%	0.0%
1.50"	37.50	100%	100%	100.0%	0.0%
1.25"	31.50	100%	100%	100.0%	0.0%
1.00"	25.00	100%	100%	100.0%	0.0%
3/4"	19.00	100%	100%	100.0%	0.0%
5/8"	16.00	100%	100%	100.0%	0.0%
1/2"	12.50	100%	100%	100.0%	0.0%
3/8"	9.50	100%	100%	100.0%	0.0%
1/4"	6.30	100%	100%	100.0%	0.0%
#4	4.75	100%	100%	100.0%	0.0%
#8	2.36	100%	100%	100.0%	0.0%
#10	2.00	100%	100%	100.0%	0.0%
#16	1.18	79%	89%	100.0%	0.0%
#20	0.850	79%	84%	100.0%	0.0%
#30	0.600	79%	81%	100.0%	0.0%
#40	0.425	79%	79%	100.0%	0.0%
#50	0.300	30%	56%	100.0%	0.0%
#60	0.250	30%	48%	100.0%	0.0%
#80	0.180	30%	35%	100.0%	0.0%
#100	0.150	30%	30%	100.0%	0.0%
#140	0.106	15.7%	21%	100.0%	0.0%
#170	0.090	15.7%	19%	100.0%	0.0%
#200	0.075	15.7%	15.7%	100.0%	0.0%




Copyright Spears Engineering & Technical Services PS, 1996-98  
 All results apply only to actual locations and materials tested. As a mutual protection to clients, the public and ourselves, all reports are submitted as the confidential property of clients, and authorization for publication of statements, conclusions or extracts from or regarding our reports is reserved pending our written approval.

**Comments:** \_\_\_\_\_

Reviewed by:   
 Meghan Blodgett-Carrillo

## Hydrometer Report

<b>Project:</b> Q.C. - Lower Duwamish Waterway <b>Project #:</b> 21B233 <b>Client:</b> Anchor QEA <b>Source:</b> LDW21-GT41-GH-0-1.3 ft <b>Sample#:</b> B21-2170	<b>Date Received:</b> 29-Jul-21 <b>Sampled By:</b> Client <b>Date Tested:</b> 18-Oct-21 <b>Tested By:</b> A. Eifrig	<b>Unified Soil Classification System, ASTM-2487</b> SM, Silty Sand <b>Sample Color</b> brown																																																																																																									
<b>ASTM D7928, HYDROMETER ANALYSIS</b>		<b>ASTM D6913</b>																																																																																																									
Sp Gr : 2.52 Sample Weight: 100.37 grams Hydrosopic Moist.: 0.83% Adj. Sample Wgt : 99.54 grams		 Certificate #: 1366.01																																																																																																									
<table border="1" style="width: 100%; border-collapse: collapse;"> <thead> <tr> <th>Hydrometer Reading Minutes</th> <th>Corrected Reading</th> <th>Percent Passing</th> <th>Soils Particle Diameter</th> </tr> </thead> <tbody> <tr><td>1</td><td>13</td><td>13.4%</td><td>0.0539 mm</td></tr> <tr><td>2</td><td>11.5</td><td>11.9%</td><td>0.0385 mm</td></tr> <tr><td>5</td><td>10.5</td><td>10.8%</td><td>0.0245 mm</td></tr> <tr><td>15</td><td>7.5</td><td>7.7%</td><td>0.0144 mm</td></tr> <tr><td>30</td><td>6.5</td><td>6.7%</td><td>0.0102 mm</td></tr> <tr><td>60</td><td>4.5</td><td>4.6%</td><td>0.0073 mm</td></tr> <tr><td>240</td><td>2.5</td><td>2.6%</td><td>0.0037 mm</td></tr> <tr><td>1440</td><td>1</td><td>1.0%</td><td>0.0015 mm</td></tr> </tbody> </table>		Hydrometer Reading Minutes	Corrected Reading	Percent Passing	Soils Particle Diameter	1	13	13.4%	0.0539 mm	2	11.5	11.9%	0.0385 mm	5	10.5	10.8%	0.0245 mm	15	7.5	7.7%	0.0144 mm	30	6.5	6.7%	0.0102 mm	60	4.5	4.6%	0.0073 mm	240	2.5	2.6%	0.0037 mm	1440	1	1.0%	0.0015 mm	<table border="1" style="width: 100%; border-collapse: collapse;"> <thead> <tr> <th>Sieve Size</th> <th>Percent Passing</th> <th>Soils Particle Diameter</th> </tr> </thead> <tbody> <tr><td>3.0"</td><td>100%</td><td>75.000 mm</td></tr> <tr><td>2.0"</td><td>100%</td><td>50.000 mm</td></tr> <tr><td>1.5"</td><td>100%</td><td>37.500 mm</td></tr> <tr><td>1.25"</td><td>100%</td><td>31.500 mm</td></tr> <tr><td>1.0"</td><td>100%</td><td>25.000 mm</td></tr> <tr><td>3/4"</td><td>100%</td><td>19.000 mm</td></tr> <tr><td>5/8"</td><td>100%</td><td>16.000 mm</td></tr> <tr><td>1/2"</td><td>100%</td><td>12.500 mm</td></tr> <tr><td>3/8"</td><td>100%</td><td>9.500 mm</td></tr> <tr><td>1/4"</td><td>100%</td><td>6.300 mm</td></tr> <tr><td>#4</td><td>100%</td><td>4.750 mm</td></tr> <tr><td>#10</td><td>100%</td><td>2.000 mm</td></tr> <tr><td>#20</td><td>84%</td><td>0.850 mm</td></tr> <tr><td>#40</td><td>79%</td><td>0.425 mm</td></tr> <tr><td>#100</td><td>30%</td><td>0.150 mm</td></tr> <tr><td>#200</td><td>15.7%</td><td>0.075 mm</td></tr> <tr><td><b>Silts</b></td><td>15.6%</td><td>0.074 mm</td></tr> <tr><td></td><td>12.7%</td><td>0.050 mm</td></tr> <tr><td></td><td>9.4%</td><td>0.020 mm</td></tr> <tr><td><b>Clays</b></td><td>3.3%</td><td>0.005 mm</td></tr> <tr><td></td><td>1.4%</td><td>0.002 mm</td></tr> <tr><td><b>Colloids</b></td><td>0.7%</td><td>0.001 mm</td></tr> </tbody> </table>	Sieve Size	Percent Passing	Soils Particle Diameter	3.0"	100%	75.000 mm	2.0"	100%	50.000 mm	1.5"	100%	37.500 mm	1.25"	100%	31.500 mm	1.0"	100%	25.000 mm	3/4"	100%	19.000 mm	5/8"	100%	16.000 mm	1/2"	100%	12.500 mm	3/8"	100%	9.500 mm	1/4"	100%	6.300 mm	#4	100%	4.750 mm	#10	100%	2.000 mm	#20	84%	0.850 mm	#40	79%	0.425 mm	#100	30%	0.150 mm	#200	15.7%	0.075 mm	<b>Silts</b>	15.6%	0.074 mm		12.7%	0.050 mm		9.4%	0.020 mm	<b>Clays</b>	3.3%	0.005 mm		1.4%	0.002 mm	<b>Colloids</b>	0.7%	0.001 mm
Hydrometer Reading Minutes	Corrected Reading	Percent Passing	Soils Particle Diameter																																																																																																								
1	13	13.4%	0.0539 mm																																																																																																								
2	11.5	11.9%	0.0385 mm																																																																																																								
5	10.5	10.8%	0.0245 mm																																																																																																								
15	7.5	7.7%	0.0144 mm																																																																																																								
30	6.5	6.7%	0.0102 mm																																																																																																								
60	4.5	4.6%	0.0073 mm																																																																																																								
240	2.5	2.6%	0.0037 mm																																																																																																								
1440	1	1.0%	0.0015 mm																																																																																																								
Sieve Size	Percent Passing	Soils Particle Diameter																																																																																																									
3.0"	100%	75.000 mm																																																																																																									
2.0"	100%	50.000 mm																																																																																																									
1.5"	100%	37.500 mm																																																																																																									
1.25"	100%	31.500 mm																																																																																																									
1.0"	100%	25.000 mm																																																																																																									
3/4"	100%	19.000 mm																																																																																																									
5/8"	100%	16.000 mm																																																																																																									
1/2"	100%	12.500 mm																																																																																																									
3/8"	100%	9.500 mm																																																																																																									
1/4"	100%	6.300 mm																																																																																																									
#4	100%	4.750 mm																																																																																																									
#10	100%	2.000 mm																																																																																																									
#20	84%	0.850 mm																																																																																																									
#40	79%	0.425 mm																																																																																																									
#100	30%	0.150 mm																																																																																																									
#200	15.7%	0.075 mm																																																																																																									
<b>Silts</b>	15.6%	0.074 mm																																																																																																									
	12.7%	0.050 mm																																																																																																									
	9.4%	0.020 mm																																																																																																									
<b>Clays</b>	3.3%	0.005 mm																																																																																																									
	1.4%	0.002 mm																																																																																																									
<b>Colloids</b>	0.7%	0.001 mm																																																																																																									
<b>USDA Soil Textural Classification</b>																																																																																																											
<table border="1" style="width: 100%; border-collapse: collapse;"> <thead> <tr> <th></th> <th>Particle Size</th> </tr> </thead> <tbody> <tr><td>% Sand:</td><td>2.0 - 0.05 mm</td></tr> <tr><td>% Silt:</td><td>0.05 - 0.002 mm</td></tr> <tr><td>% Clay:</td><td>&lt; 0.002 mm</td></tr> </tbody> </table>			Particle Size	% Sand:	2.0 - 0.05 mm	% Silt:	0.05 - 0.002 mm	% Clay:	< 0.002 mm																																																																																																		
	Particle Size																																																																																																										
% Sand:	2.0 - 0.05 mm																																																																																																										
% Silt:	0.05 - 0.002 mm																																																																																																										
% Clay:	< 0.002 mm																																																																																																										
<b>USDA Soil Textural Classification</b>																																																																																																											
Sand																																																																																																											

All results apply only to actual locations and materials tested. As a mutual protection to clients, the public and ourselves, all reports are submitted as the confidential property of clients, and authorization for publication of statements, conclusions or extracts from or regarding our reports is reserved pending our written approval.

**Comments:** \_\_\_\_\_

\_\_\_\_\_

\_\_\_\_\_

**Reviewed by:**  \_\_\_\_\_  
 Meghan Blodgett-Carrillo

# Direct Shear Test Results:

ASTM D-3080



Project: Q.C. - Lower Duwamish Waterway  
 Project Number: 21B233  
 Laboratory Sample ID: B21-2170  
 Sample Date: 8/3/2021  
 Test Date: 10/18/2021  
 Technician: M. Carrillo

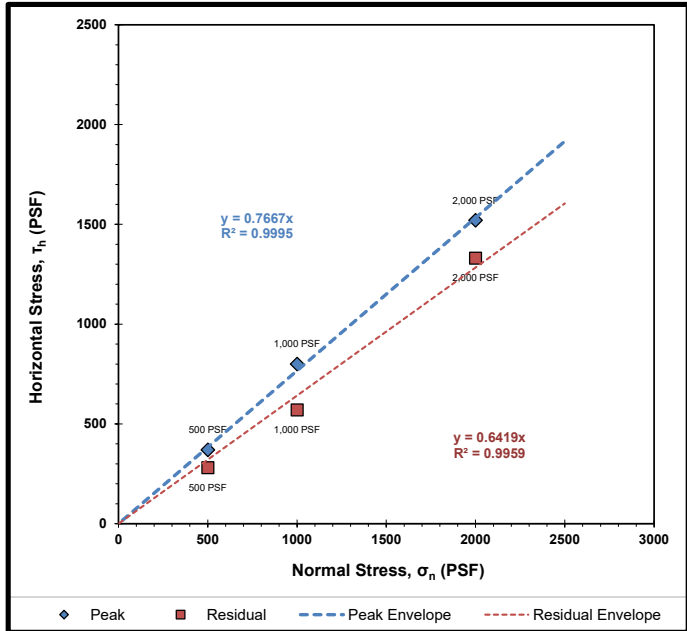
Sample Source: LDW21-GT41-GH-0-1.3 ft  
 Visual Soil Description: brown sand with silt and gravel  
 Type of Specimen: Remolded Cylindrical Shear Box  
 Specimen Diameter (in): 2.5  
 Specimen Height (in): 1  
 Rate of Strain (in/min): 0.0208  
 Estimated Specific Gravity of Solids: 2.65

Summary of Sample Data: $\sigma_n=500$ PSF		
Initial Moisture Content (%)	28.1	
	Initial	Post-Consolidation
Dry Density (PCF):	109.2	111.5
Void Ratio:	0.543	0.510
Porosity (%):	35.2	33.8
Degree of Saturation (%):	saturated	saturated

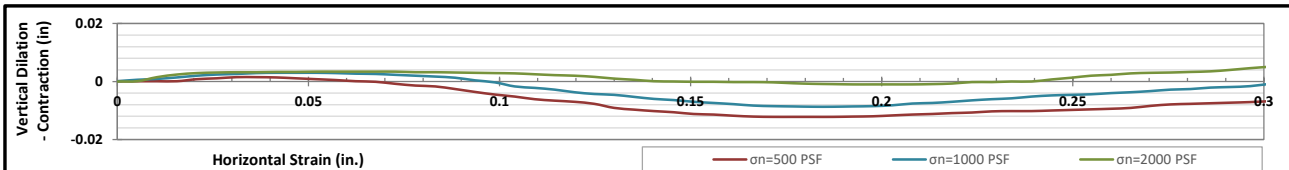
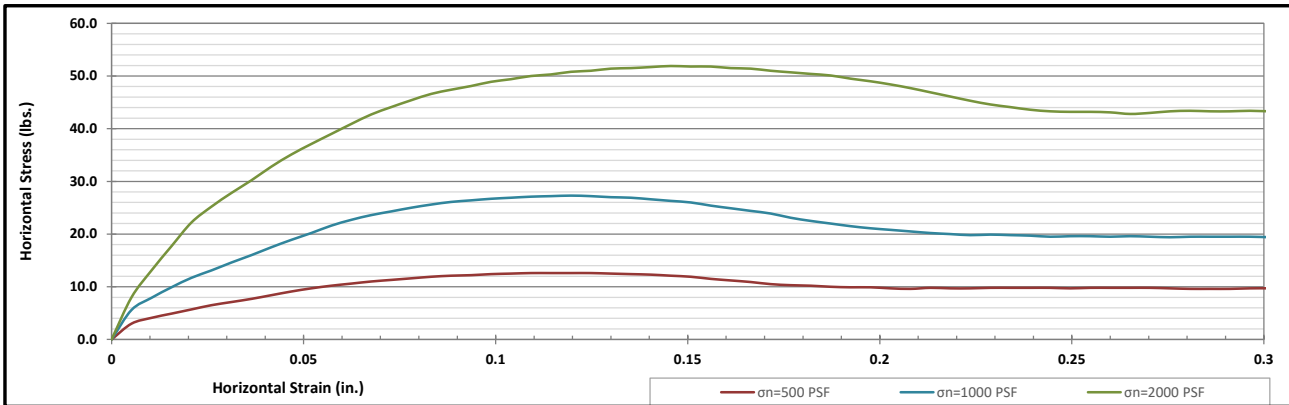
Summary of Sample Data: $\sigma_n=1000$ PSF		
Initial Moisture Content (%)	27.3	
	Initial	Post-Consolidation
Dry Density (PCF):	110.2	115.1
Void Ratio:	0.529	0.464
Porosity (%):	34.6	31.7
Degree of Saturation (%):	saturated	saturated

Summary of Sample Data: $\sigma_n=2000$ PSF		
Initial Moisture Content (%)	28.4	
	Initial	Post-Consolidation
Dry Density (PCF):	109.1	119.9
Void Ratio:	0.545	0.405
Porosity (%):	35.3	28.8
Degree of Saturation (%):	saturated	saturated

ESTIMATED STRENGTH PARAMETERS		
	PEAK	RESIDUAL
Angle of Internal Friction, $\phi$ (°):	37	33
Cohesion (PSF):	0	0



Failure Envelope Test Values:			
Normal Stress, $\sigma_n$ (PSF):	500	1000	2000
Peak Horizontal Stress, $\tau_h$ (PSF):	370	800	1520
Residual Horizontal Stress, $\tau_r$ (PSF):	280	570	1330



Corporate • 777 Chrysler Drive • Burlington, WA 98233 • Phone 360.755.1990 • Fax 360.755.1980  
 SW Region • 2118 Black Lake Blvd. S.W. • Olympia, WA 98512 • Phone 360.534.9777 • Fax 360.534.9779  
 NW Region • 805 Dupont, Suite #5 • Bellingham, WA 98225 • Phone 360.647.6061 • Fax 360.647.8111  
 Kitsap Region • 5451 N.W. Newberry Hill Road, Suite 101 • Silverdale, WA 98383 • Phone/Fax 360.698.6787

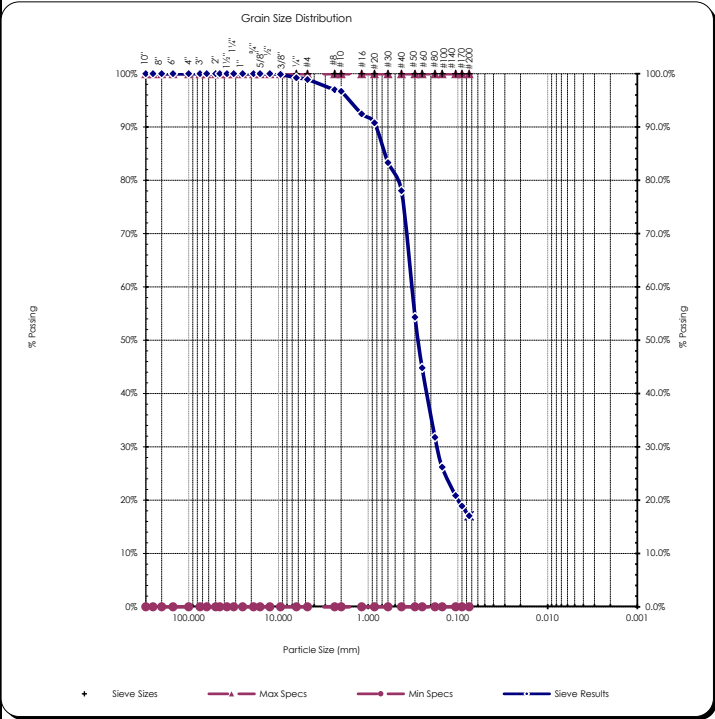
Visit our website: [www.mtc-inc.net](http://www.mtc-inc.net)

# Sieve Report

<b>Project:</b> Q.C. - Lower Duwamish Waterway <b>Project #:</b> 21B233 <b>Client:</b> Anchor QEA <b>Source:</b> LDW21-GT41-GH-1.3-2.0 ft <b>Sample#:</b> B21-2171	<b>Date Received:</b> 29-Jul-21 <b>Sampled By:</b> Client <b>Date Tested:</b> 18-Oct-21 <b>Tested By:</b> A. Eifrig	<b>Unified Soil Classification System, ASTM-2487</b> SM, Silty Sand <b>Sample Color:</b> brown	 <b>ACCREDITED</b> Certificate #: 1366.01
--	--	---	---

<b>ASTM D2216, ASTM D2419, ASTM D4318, ASTM D5281</b>			
<b>Specifications</b> No Specs <b>Sample Meets Specs ?</b> N/A	D <sub>(5)</sub> = 0.022 mm D <sub>(10)</sub> = 0.044 mm D <sub>(15)</sub> = 0.066 mm D <sub>(30)</sub> = 0.170 mm D <sub>(50)</sub> = 0.277 mm D <sub>(60)</sub> = 0.330 mm D <sub>(90)</sub> = 0.824 mm Dust Ratio = 7/32	% Gravel = 1.1% % Sand = 81.8% % Silt & Clay = 17.1% Liquid Limit = n/a Plasticity Index = n/a Sand Equivalent = n/a Fracture %, 1 Face = n/a Fracture %, 2+ Faces = n/a	Coeff. of Curvature, C <sub>c</sub> = 2.00 Coeff. of Uniformity, C <sub>u</sub> = 7.51 Fineness Modulus = 1.48 Plastic Limit = n/a Moisture %, as sampled = 33.2% Req'd Sand Equivalent = Req'd Fracture %, 1 Face = Req'd Fracture %, 2+ Faces =

<b>ASTM C136, ASTM D6913, ASTM C117</b>					
Sieve Size		Actual Cumulative Percent Passing	Interpolated Cumulative Percent Passing	Specs Max	Specs Min
US	Metric				
12.00"	300.00		100%	100.0%	0.0%
10.00"	250.00		100%	100.0%	0.0%
8.00"	200.00		100%	100.0%	0.0%
6.00"	150.00		100%	100.0%	0.0%
4.00"	100.00		100%	100.0%	0.0%
3.00"	75.00		100%	100.0%	0.0%
2.50"	63.00		100%	100.0%	0.0%
2.00"	50.00	100%	100%	100.0%	0.0%
1.75"	45.00	100%	100%	100.0%	0.0%
1.50"	37.50	100%	100%	100.0%	0.0%
1.25"	31.50	100%	100%	100.0%	0.0%
1.00"	25.00	100%	100%	100.0%	0.0%
3/4"	19.00	100%	100%	100.0%	0.0%
5/8"	16.00	100%	100%	100.0%	0.0%
1/2"	12.50	100%	100%	100.0%	0.0%
3/8"	9.50	100%	100%	100.0%	0.0%
1/4"	6.30	99%	99%	100.0%	0.0%
#4	4.75	99%	99%	100.0%	0.0%
#8	2.36	97%	97%	100.0%	0.0%
#10	2.00	97%	97%	100.0%	0.0%
#16	1.18	92%	92%	100.0%	0.0%
#20	0.850	91%	91%	100.0%	0.0%
#30	0.600	83%	83%	100.0%	0.0%
#40	0.425	78%	78%	100.0%	0.0%
#50	0.300	54%	54%	100.0%	0.0%
#60	0.250	45%	45%	100.0%	0.0%
#80	0.180	32%	32%	100.0%	0.0%
#100	0.150	26%	26%	100.0%	0.0%
#140	0.106	21%	21%	100.0%	0.0%
#170	0.090	19%	19%	100.0%	0.0%
#200	0.075	17.1%	17.1%	100.0%	0.0%



Copyright Spears Engineering & Technical Services PS, 1996-98  
 All results apply only to actual locations and materials tested. As a mutual protection to clients, the public and ourselves, all reports are submitted as the confidential property of clients, and authorization for publication of statements, conclusions or extracts from or regarding our reports is reserved pending our written approval.

**Comments:** \_\_\_\_\_

Reviewed by:   
 Meghan Blodgett-Carrillo

## ASTM D4318 - Liquid Limit, Plastic Limit and Plasticity Index of Soils

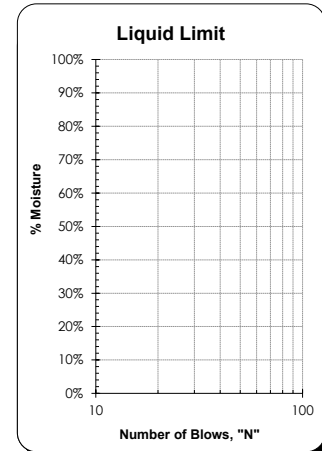
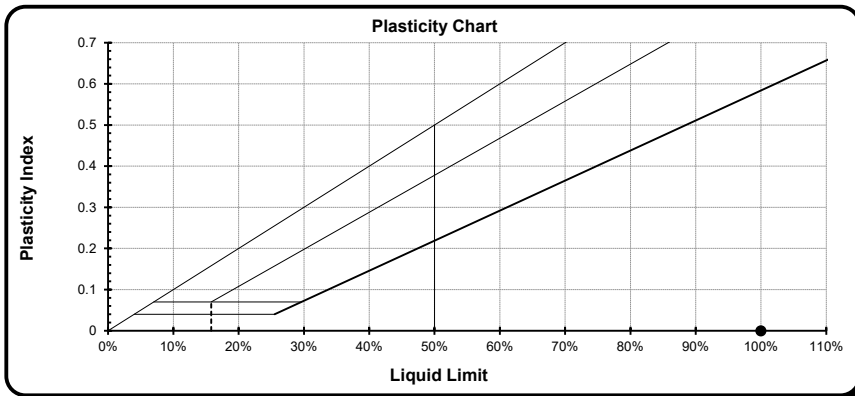
<b>Project:</b> Q.C. - Lower Duwamish Waterway <b>Project #:</b> 21B233 <b>Client:</b> Anchor QEA <b>Source:</b> LDW21-GT42-GH-0-0.3 ft <b>Sample #:</b> B21-2172	<b>Date Received:</b> 29-Jul-21 <b>Sampled By:</b> Client <b>Date Tested:</b> 18-Oct-21 <b>Tested By:</b> A. Eifrig	<b>Visual Identification</b> Silt with Organics <b>Sample Color</b> brown
---	--	--

Liquid Limit Determination						
	#1	#2	#3	#4	#5	#6
Weight of Wet Soils + Pan:	Unable to establish liquid limit					
Weight of Dry Soils + Pan:						
Weight of Pan:						
Weight of Dry Soils:						
Weight of Moisture:						
% Moisture:						
Number of Blows:						



**Liquid Limit @ 25 Blows:** N/A  
**Plastic Limit:** N/A  
**Plasticity Index, I<sub>p</sub>:** N/A

Plastic Limit Determination						
	#1	#2	#3	#4	#5	#6
Weight of Wet Soils + Pan:	Cannot determined plastic limit					
Weight of Dry Soils + Pan:						
Weight of Pan:						
Weight of Dry Soils:						
Weight of Moisture:						
% Moisture:						



Copyright Spears Engineering & Technical Services PS, 1996-98

All results apply only to actual locations and materials tested. As a mutual protection to clients, the public and ourselves, all reports are submitted as the confidential property of clients, and authorization for publication of statements, conclusions or extracts from or regarding our reports is reserved pending our written approval.

**Comments:** Liquid limit cannot be established as the material displays rapid dilation. At lower moistures the material does not spread into the cup without tearing the soil cake. Plastic limit cannot be determined as the sample does not roll down to 1/8" threads before cracking or crumbling. Non-plastic.

Reviewed by: \_\_\_\_\_  
 Meghan Blodgett-Carrillo



# Sieve Report

<b>Project:</b> Q.C. - Lower Duwamish Waterway <b>Project #:</b> 21B233 <b>Client:</b> Anchor QEA <b>Source:</b> LDW21-GT42-GH-0.3-1.5 ft <b>Sample#:</b> B21-2173	<b>Date Received:</b> 29-Jul-21 <b>Sampled By:</b> Client <b>Date Tested:</b> 18-Oct-21 <b>Tested By:</b> A. Eifrig	<b>Visual Identification</b> Sandy Silt with Clay <b>Sample Color:</b> brown
--	--	---



**ASTM D2216, ASTM D2419, ASTM D4318, ASTM D5281**

**Specifications**

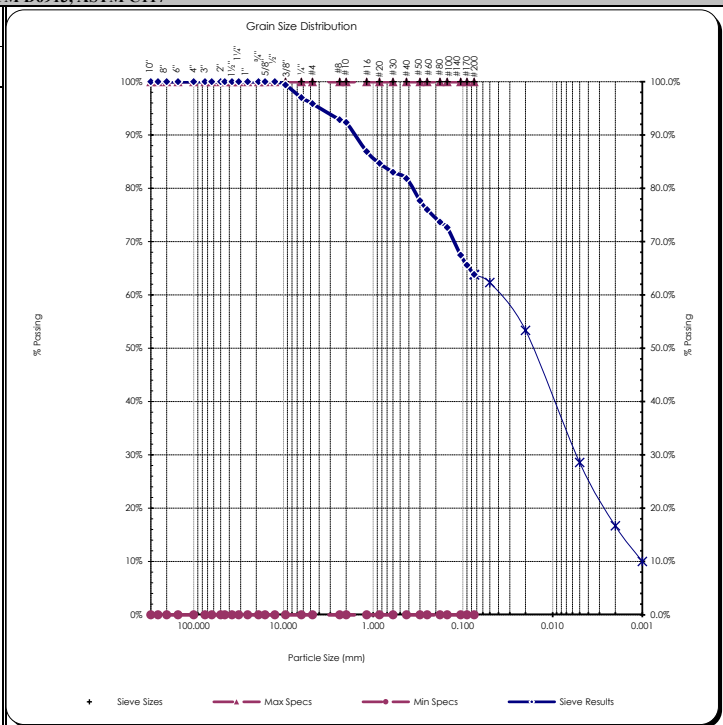
No Specs

**Sample Meets Specs ? N/A**

D <sub>(5)</sub> = 0.000 mm	% Gravel = 4.1%	Coeff. of Curvature, C <sub>c</sub> = 0.79
D <sub>(10)</sub> = 0.001 mm	% Sand = 32.0%	Coeff. of Uniformity, C <sub>u</sub> = 37.10
D <sub>(15)</sub> = 0.002 mm	% Silt & Clay = 63.8%	Fineness Modulus = 0.92
D <sub>(30)</sub> = 0.005 mm	Liquid Limit = n/a	Plastic Limit = n/a
D <sub>(50)</sub> = 0.017 mm	Plasticity Index = n/a	Moisture %, as sampled = 33.3%
D <sub>(60)</sub> = 0.037 mm	Sand Equivalent = n/a	Req'd Sand Equivalent =
D <sub>(90)</sub> = 1.643 mm	Fracture %, 1 Face = n/a	Req'd Fracture %, 1 Face =
Dust Ratio = 39/50	Fracture %, 2+ Faces = n/a	Req'd Fracture %, 2+ Faces =

**ASTM C136, ASTM D6913, ASTM C117**

Sieve Size		Actual Cumulative Percent Passing	Interpolated Cumulative Percent Passing	Specs Max	Specs Min
US	Metric				
12.00"	300.00		100%	100.0%	0.0%
10.00"	250.00		100%	100.0%	0.0%
8.00"	200.00		100%	100.0%	0.0%
6.00"	150.00		100%	100.0%	0.0%
4.00"	100.00		100%	100.0%	0.0%
3.00"	75.00		100%	100.0%	0.0%
2.50"	63.00		100%	100.0%	0.0%
2.00"	50.00	100%	100%	100.0%	0.0%
1.75"	45.00	100%	100%	100.0%	0.0%
1.50"	37.50	100%	100%	100.0%	0.0%
1.25"	31.50	100%	100%	100.0%	0.0%
1.00"	25.00	100%	100%	100.0%	0.0%
3/4"	19.00	100%	100%	100.0%	0.0%
5/8"	16.00	100%	100%	100.0%	0.0%
1/2"	12.50	100%	100%	100.0%	0.0%
3/8"	9.50	99%	99%	100.0%	0.0%
1/4"	6.30	97%	97%	100.0%	0.0%
#4	4.75	96%	96%	100.0%	0.0%
#8	2.36	93%	93%	100.0%	0.0%
#10	2.00	92%	92%	100.0%	0.0%
#16	1.18	87%	87%	100.0%	0.0%
#20	0.850	85%	85%	100.0%	0.0%
#30	0.600	83%	83%	100.0%	0.0%
#40	0.425	82%	82%	100.0%	0.0%
#50	0.300	78%	78%	100.0%	0.0%
#60	0.250	76%	76%	100.0%	0.0%
#80	0.180	74%	74%	100.0%	0.0%
#100	0.150	73%	73%	100.0%	0.0%
#140	0.106	67%	67%	100.0%	0.0%
#170	0.090	66%	66%	100.0%	0.0%
#200	0.075	63.8%	63.8%	100.0%	0.0%



Copyright Spears Engineering & Technical Services PS, 1996-98

All results apply only to actual locations and materials tested. As a mutual protection to clients, the public and ourselves, all reports are submitted as the confidential property of clients, and authorization for publication of statements, conclusions or extracts from or regarding our reports is reserved pending our written approval.

**Comments:**

Reviewed by: *Meghan Blodgett-Carrillo*  
 Meghan Blodgett-Carrillo



## Hydrometer Report

<b>Project:</b> Q.C. - Lower Duwamish Waterway <b>Date Received:</b> 29-Jul-21 <b>Project #:</b> 21B233 <b>Sampled By:</b> Client <b>Client:</b> Anchor QEA <b>Date Tested:</b> 18-Oct-21 <b>Source:</b> LDW21-GT42-GH-0.3-1.5 ft <b>Tested By:</b> A. Eifrig <b>Sample#:</b> B21-2173	<b>Visual Identification</b> Sandy Silt with Clay <b>Sample Color</b> brown																																																																																																																																				
<b>ASTM D7928, HYDROMETER ANALYSIS</b>	<b>ASTM D6913</b>																																																																																																																																				
<table style="width: 100%; border-collapse: collapse;"> <tr> <td style="width: 30%;">Assumed Sp Gr :</td> <td style="width: 20%; text-align: center;">2.65</td> <td style="width: 50%;"></td> </tr> <tr> <td>Sample Weight:</td> <td style="text-align: center;">75.38</td> <td>grams</td> </tr> <tr> <td>Hydroscopic Moist.:</td> <td style="text-align: center;">1.68%</td> <td></td> </tr> <tr> <td>Adj. Sample Wgt :</td> <td style="text-align: center;">74.13</td> <td>grams</td> </tr> </table> <table style="width: 100%; border-collapse: collapse;"> <thead> <tr> <th style="text-align: left;">Hydrometer Reading</th> <th style="text-align: left;">Corrected Reading</th> <th style="text-align: left;">Percent Passing</th> <th style="text-align: left;">Soils Particle Diameter</th> </tr> </thead> <tbody> <tr><td>1</td><td style="text-align: center;">49</td><td style="text-align: center;">61.1%</td><td>0.0393 mm</td></tr> <tr><td>2</td><td style="text-align: center;">45</td><td style="text-align: center;">56.1%</td><td>0.0288 mm</td></tr> <tr><td>5</td><td style="text-align: center;">42.5</td><td style="text-align: center;">53.0%</td><td>0.0187 mm</td></tr> <tr><td>15</td><td style="text-align: center;">34.5</td><td style="text-align: center;">43.0%</td><td>0.0115 mm</td></tr> <tr><td>30</td><td style="text-align: center;">30.5</td><td style="text-align: center;">38.0%</td><td>0.0084 mm</td></tr> <tr><td>60</td><td style="text-align: center;">26</td><td style="text-align: center;">32.4%</td><td>0.0061 mm</td></tr> <tr><td>240</td><td style="text-align: center;">18</td><td style="text-align: center;">22.4%</td><td>0.0032 mm</td></tr> <tr><td>1440</td><td style="text-align: center;">11</td><td style="text-align: center;">13.7%</td><td>0.0014 mm</td></tr> </tbody> </table> <table style="width: 100%; border-collapse: collapse;"> <tr> <td style="width: 30%;">% Gravel:</td> <td style="width: 20%; text-align: center;">4.1%</td> <td style="width: 50%;"></td> </tr> <tr> <td>% Sand:</td> <td style="text-align: center;">32.0%</td> <td></td> </tr> <tr> <td>% Silt:</td> <td style="text-align: center;">35.2%</td> <td></td> </tr> <tr> <td>% Clay:</td> <td style="text-align: center;">28.6%</td> <td></td> </tr> </table> <table style="width: 100%; border-collapse: collapse;"> <tr> <td style="width: 30%;"></td> <td style="width: 20%;"></td> <td style="width: 50%;"> <b>Liquid Limit:</b> n/a  <b>Plastic Limit:</b> n/a  <b>Plasticity Index:</b> n/a         </td> </tr> </table>	Assumed Sp Gr :	2.65		Sample Weight:	75.38	grams	Hydroscopic Moist.:	1.68%		Adj. Sample Wgt :	74.13	grams	Hydrometer Reading	Corrected Reading	Percent Passing	Soils Particle Diameter	1	49	61.1%	0.0393 mm	2	45	56.1%	0.0288 mm	5	42.5	53.0%	0.0187 mm	15	34.5	43.0%	0.0115 mm	30	30.5	38.0%	0.0084 mm	60	26	32.4%	0.0061 mm	240	18	22.4%	0.0032 mm	1440	11	13.7%	0.0014 mm	% Gravel:	4.1%		% Sand:	32.0%		% Silt:	35.2%		% Clay:	28.6%				<b>Liquid Limit:</b> n/a <b>Plastic Limit:</b> n/a <b>Plasticity Index:</b> n/a	<table style="width: 100%; border-collapse: collapse;"> <tr> <th style="text-align: left;">Sieve Size</th> <th style="text-align: left;">Percent Passing</th> <th style="text-align: left;">Soils Particle Diameter</th> </tr> <tr><td>3.0"</td><td style="text-align: center;">100%</td><td>75.000 mm</td></tr> <tr><td>2.0"</td><td style="text-align: center;">100%</td><td>50.000 mm</td></tr> <tr><td>1.5"</td><td style="text-align: center;">100%</td><td>37.500 mm</td></tr> <tr><td>1.25"</td><td style="text-align: center;">100%</td><td>31.500 mm</td></tr> <tr><td>1.0"</td><td style="text-align: center;">100%</td><td>25.000 mm</td></tr> <tr><td>3/4"</td><td style="text-align: center;">100%</td><td>19.000 mm</td></tr> <tr><td>5/8"</td><td style="text-align: center;">100%</td><td>16.000 mm</td></tr> <tr><td>1/2"</td><td style="text-align: center;">100%</td><td>12.500 mm</td></tr> <tr><td>3/8"</td><td style="text-align: center;">99%</td><td>9.500 mm</td></tr> <tr><td>1/4"</td><td style="text-align: center;">97%</td><td>6.300 mm</td></tr> <tr><td>#4</td><td style="text-align: center;">96%</td><td>4.750 mm</td></tr> <tr><td>#10</td><td style="text-align: center;">92%</td><td>2.000 mm</td></tr> <tr><td>#20</td><td style="text-align: center;">85%</td><td>0.850 mm</td></tr> <tr><td>#40</td><td style="text-align: center;">82%</td><td>0.425 mm</td></tr> <tr><td>#100</td><td style="text-align: center;">73%</td><td>0.150 mm</td></tr> <tr><td>#200</td><td style="text-align: center;">63.8%</td><td>0.075 mm</td></tr> <tr><td><b>Silts</b></td><td style="text-align: center;">63.8%</td><td>0.074 mm</td></tr> <tr><td></td><td style="text-align: center;">62.3%</td><td>0.050 mm</td></tr> <tr><td></td><td style="text-align: center;">53.4%</td><td>0.020 mm</td></tr> <tr><td><b>Clays</b></td><td style="text-align: center;">28.6%</td><td>0.005 mm</td></tr> <tr><td></td><td style="text-align: center;">16.7%</td><td>0.002 mm</td></tr> <tr><td><b>Colloids</b></td><td style="text-align: center;">10.0%</td><td>0.001 mm</td></tr> </table>	Sieve Size	Percent Passing	Soils Particle Diameter	3.0"	100%	75.000 mm	2.0"	100%	50.000 mm	1.5"	100%	37.500 mm	1.25"	100%	31.500 mm	1.0"	100%	25.000 mm	3/4"	100%	19.000 mm	5/8"	100%	16.000 mm	1/2"	100%	12.500 mm	3/8"	99%	9.500 mm	1/4"	97%	6.300 mm	#4	96%	4.750 mm	#10	92%	2.000 mm	#20	85%	0.850 mm	#40	82%	0.425 mm	#100	73%	0.150 mm	#200	63.8%	0.075 mm	<b>Silts</b>	63.8%	0.074 mm		62.3%	0.050 mm		53.4%	0.020 mm	<b>Clays</b>	28.6%	0.005 mm		16.7%	0.002 mm	<b>Colloids</b>	10.0%	0.001 mm
Assumed Sp Gr :	2.65																																																																																																																																				
Sample Weight:	75.38	grams																																																																																																																																			
Hydroscopic Moist.:	1.68%																																																																																																																																				
Adj. Sample Wgt :	74.13	grams																																																																																																																																			
Hydrometer Reading	Corrected Reading	Percent Passing	Soils Particle Diameter																																																																																																																																		
1	49	61.1%	0.0393 mm																																																																																																																																		
2	45	56.1%	0.0288 mm																																																																																																																																		
5	42.5	53.0%	0.0187 mm																																																																																																																																		
15	34.5	43.0%	0.0115 mm																																																																																																																																		
30	30.5	38.0%	0.0084 mm																																																																																																																																		
60	26	32.4%	0.0061 mm																																																																																																																																		
240	18	22.4%	0.0032 mm																																																																																																																																		
1440	11	13.7%	0.0014 mm																																																																																																																																		
% Gravel:	4.1%																																																																																																																																				
% Sand:	32.0%																																																																																																																																				
% Silt:	35.2%																																																																																																																																				
% Clay:	28.6%																																																																																																																																				
		<b>Liquid Limit:</b> n/a <b>Plastic Limit:</b> n/a <b>Plasticity Index:</b> n/a																																																																																																																																			
Sieve Size	Percent Passing	Soils Particle Diameter																																																																																																																																			
3.0"	100%	75.000 mm																																																																																																																																			
2.0"	100%	50.000 mm																																																																																																																																			
1.5"	100%	37.500 mm																																																																																																																																			
1.25"	100%	31.500 mm																																																																																																																																			
1.0"	100%	25.000 mm																																																																																																																																			
3/4"	100%	19.000 mm																																																																																																																																			
5/8"	100%	16.000 mm																																																																																																																																			
1/2"	100%	12.500 mm																																																																																																																																			
3/8"	99%	9.500 mm																																																																																																																																			
1/4"	97%	6.300 mm																																																																																																																																			
#4	96%	4.750 mm																																																																																																																																			
#10	92%	2.000 mm																																																																																																																																			
#20	85%	0.850 mm																																																																																																																																			
#40	82%	0.425 mm																																																																																																																																			
#100	73%	0.150 mm																																																																																																																																			
#200	63.8%	0.075 mm																																																																																																																																			
<b>Silts</b>	63.8%	0.074 mm																																																																																																																																			
	62.3%	0.050 mm																																																																																																																																			
	53.4%	0.020 mm																																																																																																																																			
<b>Clays</b>	28.6%	0.005 mm																																																																																																																																			
	16.7%	0.002 mm																																																																																																																																			
<b>Colloids</b>	10.0%	0.001 mm																																																																																																																																			
<b>USDA Soil Textural Classification</b>																																																																																																																																					
<table style="width: 100%; border-collapse: collapse;"> <tr> <td style="width: 30%;"></td> <td style="width: 20%;"></td> <td style="width: 50%;"> <b>Particle Size</b>            % Sand: 2.0 - 0.05 mm            % Silt: 0.05 - 0.002 mm            % Clay: &lt; 0.002 mm         </td> </tr> </table> <table style="width: 100%; border-collapse: collapse;"> <tr> <td style="width: 30%;"></td> <td style="width: 20%;"></td> <td style="width: 50%; text-align: center;"> <b>USDA Soil Textural Classification</b>            Loam         </td> </tr> </table>			<b>Particle Size</b> % Sand: 2.0 - 0.05 mm % Silt: 0.05 - 0.002 mm % Clay: < 0.002 mm			<b>USDA Soil Textural Classification</b> Loam																																																																																																																															
		<b>Particle Size</b> % Sand: 2.0 - 0.05 mm % Silt: 0.05 - 0.002 mm % Clay: < 0.002 mm																																																																																																																																			
		<b>USDA Soil Textural Classification</b> Loam																																																																																																																																			

All results apply only to actual locations and materials tested. As a mutual protection to clients, the public and ourselves, all reports are submitted as the confidential property of clients, and authorization for publication of statements, conclusions or extracts from or regarding our reports is reserved pending our written approval.

**Comments:** \_\_\_\_\_

\_\_\_\_\_

\_\_\_\_\_

**Reviewed by:** \_\_\_\_\_  
 Meghan Blodgett-Carrillo

# Direct Shear Test Results:

ASTM D-3080



Project: Q.C. - Lower Duwamish Waterway  
 Project Number: 21B233  
 Laboratory Sample ID: B21-2173  
 Sample Date: 8/3/2021  
 Test Date: 10-19-21 through 10-21-21  
 Technician: M. Carrillo

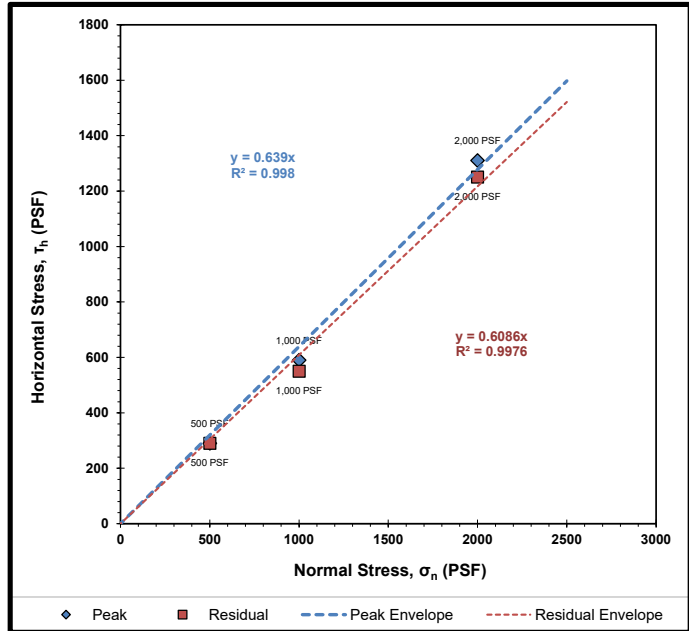
Sample Source: LDW21-GT42-GH-0.3-1.5 ft  
 Visual Soil Description: brown clay with silt  
 Type of Specimen: Remolded Cylindrical Shear Box  
 Specimen Diameter (in): 2.5  
 Specimen Height (in): 1  
 Rate of Strain (in/min): 0.0012  
 Estimated Specific Gravity of Solids: 2.65

Summary of Sample Data: $\sigma_n=500$ PSF		
Initial Moisture Content (%)	34.0	
	Initial	Post-Consolidation
Dry Density (PCF):	102.5	106.8
Void Ratio:	0.644	0.578
Porosity (%):	39.2	36.6
Degree of Saturation (%):	saturated	saturated

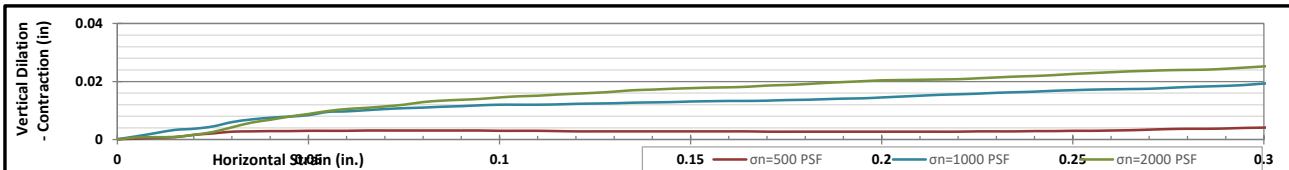
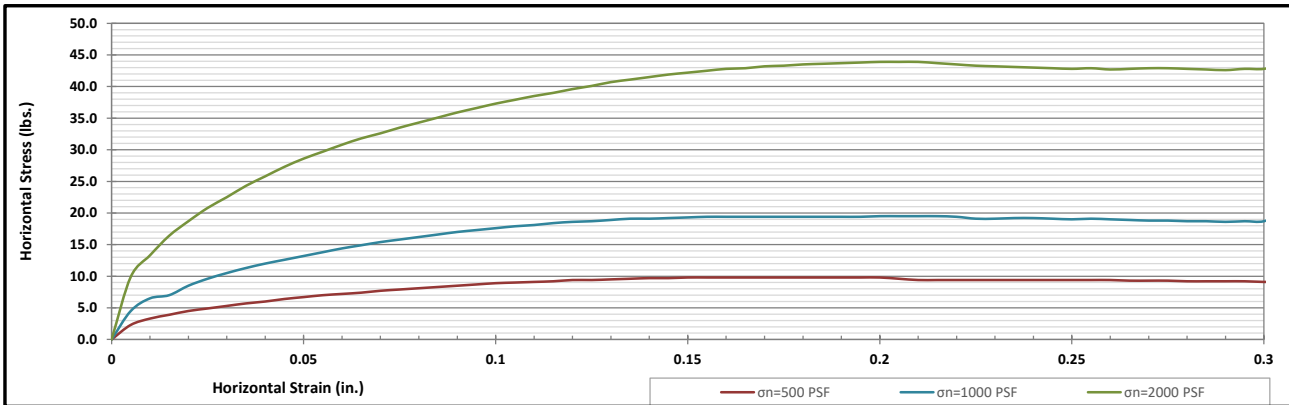
Summary of Sample Data: $\sigma_n=1000$ PSF		
Initial Moisture Content (%)	31.5	
	Initial	Post-Consolidation
Dry Density (PCF):	104.6	114.9
Void Ratio:	0.611	0.467
Porosity (%):	37.9	31.8
Degree of Saturation (%):	saturated	saturated

Summary of Sample Data: $\sigma_n=2000$ PSF		
Initial Moisture Content (%)	28.9	
	Initial	Post-Consolidation
Dry Density (PCF):	107.0	120.1
Void Ratio:	0.574	0.403
Porosity (%):	36.5	28.7
Degree of Saturation (%):	saturated	saturated

ESTIMATED STRENGTH PARAMETERS		
	PEAK	RESIDUAL
Angle of Internal Friction, $\phi$ (°):	33	31
Cohesion (PSF):	0	0



Failure Envelope Test Values:			
Normal Stress, $\sigma_n$ (PSF):	500	1000	2000
Peak Horizontal Stress, $\tau_h$ (PSF):	290	590	1310
Residual Horizontal Stress, $\tau_h$ (PSF):	290	550	1250




Corporate • 777 Chrysler Drive • Burlington, WA 98233 • Phone 360.755.1990 • Fax 360.755.1980  
 SW Region • 2118 Black Lake Blvd. S.W. • Olympia, WA 98512 • Phone 360.534.9777 • Fax 360.534.9779  
 NW Region • 805 Dupont, Suite #5 • Bellingham, WA 98225 • Phone 360.647.6061 • Fax 360.647.8111  
 Kitsap Region • 5451 N.W. Newberry Hill Road, Suite 101 • Silverdale, WA 98383 • Phone/Fax 360.698.6787

Visit our website: [www.mtc-inc.net](http://www.mtc-inc.net)

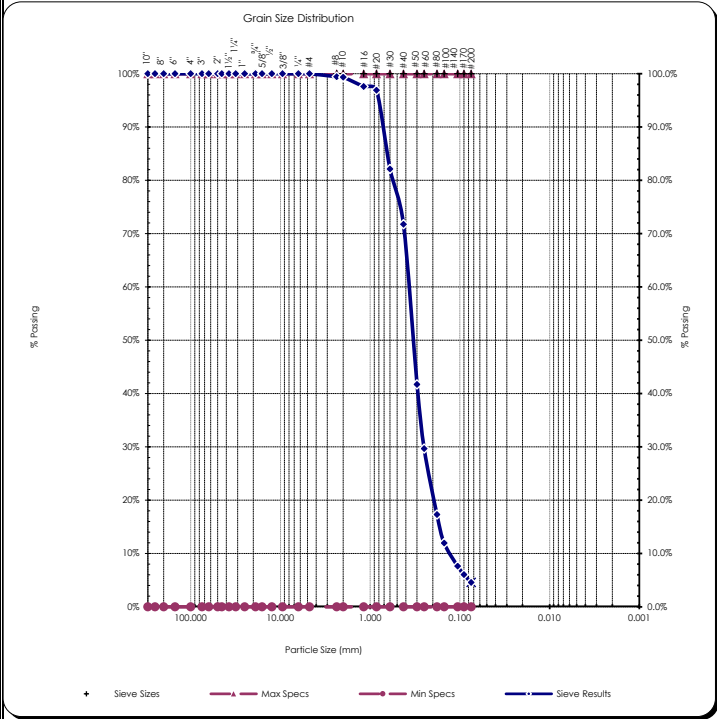


# Sieve Report

<b>Project:</b> Q.C. - Lower Duwamish Waterway <b>Project #:</b> 21B233 <b>Client:</b> Anchor QEA <b>Source:</b> LDW21-GT42-GH-1.5-2.3 ft <b>Sample#:</b> B21-2174	<b>Date Received:</b> 29-Jul-21 <b>Sampled By:</b> Client <b>Date Tested:</b> 18-Oct-21 <b>Tested By:</b> A. Eifrig	<b>Unified Soil Classification System, ASTM-2487</b> SP, Poorly graded Sand <b>Sample Color:</b> brown	 <b>ACCREDITED</b> Certificate #: 1366.01
--	--	---	--

<b>ASTM D2216, ASTM D2419, ASTM D4318, ASTM D5281</b>			
<b>Specifications</b> No Specs <b>Sample Meets Specs ?</b> N/A	D <sub>(5)</sub> = 0.075 mm D <sub>(10)</sub> = 0.150 mm D <sub>(15)</sub> = 0.167 mm D <sub>(30)</sub> = 0.251 mm D <sub>(50)</sub> = 0.334 mm D <sub>(60)</sub> = 0.376 mm D <sub>(90)</sub> = 0.733 mm Dust Ratio = 3/47	% Gravel = 0.0% % Sand = 95.4% % Silt & Clay = 4.6% Liquid Limit = n/a Plasticity Index = n/a Sand Equivalent = n/a Fracture %, 1 Face = n/a Fracture %, 2+ Faces = n/a	Coeff. of Curvature, C <sub>c</sub> = 1.29 Coeff. of Uniformity, C <sub>u</sub> = 2.90 Fineness Modulus = 1.67 Plastic Limit = n/a Moisture %, as sampled = 17.0% Req'd Sand Equivalent = Req'd Fracture %, 1 Face = Req'd Fracture %, 2+ Faces =

<b>ASTM C136, ASTM D6913, ASTM C117</b>					
<b>Sieve Size</b>		<b>Actual Cumulative Percent Passing</b>	<b>Interpolated Cumulative Percent Passing</b>	<b>Specs Max</b>	<b>Specs Min</b>
<b>US</b>	<b>Metric</b>				
12.00"	300.00		100%	100.0%	0.0%
10.00"	250.00		100%	100.0%	0.0%
8.00"	200.00		100%	100.0%	0.0%
6.00"	150.00		100%	100.0%	0.0%
4.00"	100.00		100%	100.0%	0.0%
3.00"	75.00		100%	100.0%	0.0%
2.50"	63.00		100%	100.0%	0.0%
2.00"	50.00	100%	100%	100.0%	0.0%
1.75"	45.00	100%	100%	100.0%	0.0%
1.50"	37.50	100%	100%	100.0%	0.0%
1.25"	31.50	100%	100%	100.0%	0.0%
1.00"	25.00	100%	100%	100.0%	0.0%
3/4"	19.00	100%	100%	100.0%	0.0%
5/8"	16.00	100%	100%	100.0%	0.0%
1/2"	12.50	100%	100%	100.0%	0.0%
3/8"	9.50	100%	100%	100.0%	0.0%
1/4"	6.30	100%	100%	100.0%	0.0%
#4	4.75	100%	100%	100.0%	0.0%
#8	2.36	99%	99%	100.0%	0.0%
#10	2.00	99%	99%	100.0%	0.0%
#16	1.18	97%	98%	100.0%	0.0%
#20	0.850	97%	97%	100.0%	0.0%
#30	0.600	82%	82%	100.0%	0.0%
#40	0.425	72%	72%	100.0%	0.0%
#50	0.300	42%	42%	100.0%	0.0%
#60	0.250	30%	30%	100.0%	0.0%
#80	0.180	17%	17%	100.0%	0.0%
#100	0.150	12%	12%	100.0%	0.0%
#140	0.106	8%	8%	100.0%	0.0%
#170	0.090	6%	6%	100.0%	0.0%
#200	0.075	4.6%	4.6%	100.0%	0.0%



Copyright Spears Engineering & Technical Services PS, 1996-98  
 All results apply only to actual locations and materials tested. As a mutual protection to clients, the public and ourselves, all reports are submitted as the confidential property of clients, and authorization for publication of statements, conclusions or extracts from or regarding our reports is reserved pending our written approval.

**Comments:** \_\_\_\_\_

Reviewed by:   
 Meghan Blodgett-Carrillo

## Appendix G – Geotechnical Design Analysis

### Attachment G.3

### Supplemental Geotechnical Information by Others

---

**Table G.3-1**  
**Historical Geotechnical Investigations and Geologic Information**

File Title	Identification No. <sup>1</sup>	River Mile	Document Title	Document type	Date Document Creation	Project Location	Sample Types/Report Info	Author
RM 2.9_Boeing_east bank	1	2.9	n/a	partial report/figures	9.11.1990	1135 S. Webster Street (Boeing Company), east bank	CPT logs, MW logs, grain size analysis, boring logs	Geoengineers
Boeing Plant 2_east bank	2, 8, 9, 10	3.1-3.5	Appendix C: Geotechnical Engineering Report, Habitat Project	report	10.2012	Boeing Plant 2 (Seattle/Tukwila)	Subsurface conditions, seismic conditions, liquefaction and lateral spreading analysis, slope stability analysis, shoreline excavation and dredging	AMEC, Floyd Snider, Dalton Olmsted & Fuglevand
RM 3.1-3.3 Boeing Technology Complex_east bank	3	3.1-3.3	Report of Geotechnical Investigation, Proposed Boeing Materials Technology Complex	report	8.13.1992	Boeing North Duwamish Campus, East Bank	Site conditions, subsurface/groundwater conditions, CPT logs, grain size, excavations, pile foundations, seismic aspects	Dames & Moore
RM 3.02_S Monroe St_west bank	4	3.12	Site plan	figures	8.22.1986	South Monroe Street, southwest side Duwamish	Site plan, 2 boring logs with blow counts, observation well install	Geoengineers
RM 3.3-3.6_Boeing Plant 2_east bank	5	3.3-3.6	Boeing Plant 2 RFI	figures (site thickness map, boring logs)	07.3.1997	Boeing Plant 2 (E Marginal Way S and 16th Ave S)	Boring logs, silt thickness and till units	Weston
RM 3_South Park Neighborhood_west bank	6	3.3	South Park Neighborhood Development Program Subsurface Investigations	report	8.1973	South Park Neighborhood	11 test boings (HSA), SPTs, 2 observation well installs, cross sections	Shannon & Wilson
RM 3.33-South Park Bridge	7	3.3	South Park Bridge Replacement Volume 3: Geotechnical Report	compiled reports	8.2007	South Park Bridge	Full geotechnical study (boring logs, seismic, liquefaction, soil motion, soil surface response spectra, shear wave velocity, rock input, etc.)	PB Americas, Shannon & Wilson
Terminal 117 Site Restoration GT Report - Rev 1	11	3.55	Terminal 117 Site Restoration	report	05.07.2014	Terminal 117: Duwamish waterway to the east, Dallas Avenue to the south. South Park marina to the north, parking lot to the west. (Flat around 15 ft)	Subsurface/surface conditions, GW, SPTs, earthquake engineering, liquefaction, design soil parameters, slope stability, ground improvement, shallow foundations, pile design, retaining walls, site development and earthwork	Geoengineers
RM 4.4_Transmission Towers	12	3.5-3.6	Geotechnical and Environmental Engineering Design Study Proposed Duwamish Transmission Towers	report	9.19.2003	Boeing Plant 2. Each bank of the Duwamish River south of the 14th Street bridge (south park bridge)	2 borings, existing geotechnical data, soil/GW subsurface, engineering analysis: seismic, foundations, deep foundations, SPTs	Hart Crowser
RM 3.6 Basin Oil_west bank	13	3.6	Geotechnical Engineering Study for Basin Oil	partial report/logs	02.07.1994	Basin Oil: 8661 Dallas Avenue South, Seattle	Site map and log	Lorilla Engineering
RM 3.6 _Dallas Ave S_west bank	14	3.6	Geotechnical Memorandum	memo	06.10.2014	Dallas Avenue South	10 test pits, 10 pilot infiltration tests, includes figures and logs, grain size	Seattle Public Utilities Geotechnical Engineering
RM 3.6_Jorgensen Forge MWs_east bank	15	3.6	Jorgensen Forge Boring Logs	figure/logs	12.05.1994	8531 E. Marginal Way, Seattle	2 HSA borings to 30 ft	SECOR
Final Inv Data Summ Rpt_021306	16	3.65	Final Investigation Data Summary Report Jorgensen Forge Facility	report	2.13.2006	Jorgenson: 8531 East Marginal Way South	Surface/subsurface samples analyzed for grain size (no deviations)	Farallon Consulting and Anchor Environmental

File Title	Identification No. <sup>1</sup>	River Mile	Document Title	Document type	Date Document Creation	Project Location	Sample Types/Report Info	Author
RM 3.7_Boeing S Park Facility_west bank	17	3.7	Report of Foundation Investigation	figures/logs	06.17.1980	1420 S. Trenton Street	7 boring logs and figures	Dames & Moore
Boeing Plant 2 CPT Locations	18	3.7	CPT Locations	figure	02.09.2015	POS Parcel Boeing Isaacson	CPTs (up to 60 feet bgs)	Kennedy/Jenks
RM 3.8_1600 S Henderson St_west bank	19	3.8	Supplemental Laboratory Testing	figures/logs	09.20.1984	South Park Site: 1600 S. Henderson St.	7 boring logs	Dames & Moore
RM 4.25_Delta Boat Lift Pier_west bank	20	4.25	Limited Geotechnical Engineering Report	report	5.8.2002	Boat Lift Pier 1608 S 96th Street	1 bore hole, two grain size, 200-wash analysis, Atterberg limits	AMEC
RM_4.4_Duwamish Substation_west bank	21	4.4	Geotechnical Report Duwamish Substation Bank 79 Foundation Retrofit	report	2.28.2003	Bank 79 Transformer: (near west marginal way)	1 PCPT, 2 geophysical surveys, 3 soil borings and analysis, borings completed for MWs	Earth Technology Corporation
RM_4.4_Duwamish Substation_west bank2	22	4.4	n/a	figures/logs	10.07.1969	Duwamish Substation	47 borings (logs with coordinates)	Seattle Engineering Department
Draft Duwamish Substation Geotech Rpt	23	4.45	Draft Geotechnical Report Seattle Substation Evaluation	draft report	11.2012	Duwamish Substation	Surface/subsurface conditions, environmentally critical areas, seismic considerations, foundations, earthwork	Seattle Public Utilities Geotechnical Engineering
RM 4.4-4.6_Boeing_east bank	24	4.4-4.6	Boeing Developmental Center Logs	figures/logs	2.1.2001	East Marginal Way South (Boeing Developmental Center)	MW well as-builts, site map, lithology logs (about 30 wells)	Landau Associates
USACE Dredging 2018	25	4.0-4.7	Memorandum For Record: DMMP Suitability Determination	report	05.24.2018	Duwamish River: Stations 242+00 and 275+56 (turning basin and navigation channel)	Vibracore samples (grain size/conventional) page 18	USACE
RM 4.6-7.7_Hwy 99_west bank	26	4.6-7.7	Report on Geotechnical Exploration	report	05.30.1985	Renton Effluent Transfer System. West Marginal Way Southwest, extending from about 1,500 south of South 102nd Street to 800 feet north of Des Moines Way South	Plan and profile maps, 21 exploration borings, trench excavation, chemical testing, GW conditions, geotechnical impacts	Converse Consultants
RM 5_Oxbow bridge	27	5.0	Geotechnical Design Report	report	4.1988	North Oxbow Bridge, Boeing Developmental Center	Surface/subsurface conditions, SPTs, GW, seismic considerations, vertical/lateral pile capacity, liquefaction potential, excavation	Rittenhouse-Zeman & Associates
RM +5_Boeing Oxbow Parking Lot_west bank	South of study area	5.1	Report of Geotechnical Investigation	report	7.23.1985	Boeing Developmental Center Oxbow Parking lot (west side Duwamish)	2 CPT, 5 borings, deepest boring 54.0 ft	Converse Consultants
LDW-Final-FS-Sections-8-13_october-31-2012_ADA	n/a	n/a	Lower Duwamish Waterway Final Feasibility Study (sections 8-13)	report	10.2012	Duwamish River	Table 8-6: prior geotechnical analyses from projects in the LDW, around Harbor Island, and adjacent Elliott Bay	LDWG
LDW-Final-FS-Sections-1-7_october-31-2012_ADA	n/a	n/a	Lower Duwamish Waterway Final Feasibility Study (sections 1-7)	report	10.2012.	Duwamish River	Section 2.6: additional considerations, sediment physical properties: grain size, Atterberg limits, TOC, porosity, bulk density, etc.	LDWG

File Title	Identification No. <sup>1</sup>	River Mile	Document Title	Document type	Date Document Creation	Project Location	Sample Types/Report Info	Author
Final_LDW-RI	n/a	n/a	Lower Duwamish Waterway Remedial Investigation Report	report	7.9.2010	Duwamish River	Section 2.5.4: sediment lithology: geotechnical parameter tests and results (moisture, specific gravity, Atterberg limits, bulk density, porosity). Also physical properties. Section 9.1.6: bank erosion	LDWG
2015_11_POS_Silver_DSR_Ecology	28	3.8	Boeing Isaacson-Thompson Site, Port of Seattle Sliver Data Summary Report	report	11.12.2015	Port of Seattle Sliver Property located west of the Boeing Isaacson Property	10 soil borings (direct push) to 25 ft bgs. 41 soil samples collected. No geotechnical analysis. Includes section on lithologic conditions of site and borings logs, page 5.	Kennedy/Jenks Consultants
Boeing_I-T_Landau_042114_Final_RI	29	3.8	Final Remedial Investigation Report Boeing Isaacson-Thompson Site	report	4.21.2014	Boeing Isaacson-Thompson Site	No geotechnical analysis. Descriptions of Geologic Conditions on page 107. Discuss soil conditions at 50 exploratory locations. Summary of depth to alluvium documented in Table 9 page 290	Landau Associates, AMEC
AppJ_Basin of Design Report_08162012	30	3.5 - 3.7	Appendix J Geotechnical Basis of Design Report (Terminal 117 Cleanup Design Sediment and Upland Areas)	report	8.1.2012	Port of Seattle, Terminal 117	Six borings and 8 CPTs. 3 completed on barge, 3 completed upland. 5 SPTs completed on barge, 3 completed in upland (locations figure 1 page 23). Geologic soil units described page 10. Engineering soil properties section 3 page 14. Subsurface profile figures begin page 25.	Crete Consulting, Jacobs Associates
2012_12-19_Final Shoreline Investigation	31	4.1-4.2	Shoreline Soil and Groundwater Characterization Report	report	3.12.2012	Former Rhone-Poulenc Site, Tukwila Washington: 9229 East Marginal Way	15 direct push upland borings for soil/GW from shoreline areas. 5 areas collected geotechnical samples between 11 and 15 feet. Section 3.1 soil lithology (page 14). Section 3.5 geotechnical analysis (moisture, density, grain size, atterberg). Results table 8 page 43. Geotech locations figure 3 page 47.	AMEC
Final Interm Measures Construction Work Plan V1/V2	32	4.1-4.2	Final Interm Measures Construction Work Plan V1/V2	report	10.25.2002	Former Rhone-Poulenc Site, Tukwila Washington: 9229 East Marginal Way	Samples to confirm depth and characteristics of uppermost aquitard. CPTs for soil strength at 3 locations alongside borings GT-5, B-1-02, B-7-02 (Section 2.4 Geotech Characterization page 15). Figures page 21. Table 2-1 summarizes analytical. V2: Appendix B: Geotechnical Data	URS
2021.03.05 Figures AppA-1_B-Boeing DC Thompson Geotech Report-01052021_Final_reduced	33	3.7; 4.6; 4.9	Boeing DC Thompson Geotech Report	figures/logs	1.5.2021	Boeing Thompson Site	3 CPTs at Thompson site; 3 CPTs at Boeing Development Center; 3 CPTs near Norfolk outfall	Golder
8801 Final FS July 27, 2020	34	3.9-4.0	Final Feasibility Study 8801 East Marginal Way S., Tukwila, Washington	report	7.27.2020	Centerpoint Properties	Geologic cross sections perpendicular and parallel to the river bank through Centerpoint Properties	Shannon & Wilson

## Notes:

1. The study identification number is shown on Maps 5-2a and 5-2b. Studies with "n/a" in this field are site-wide studies.

CPT: cone penetration testing

DMMP: Dredged Material Management Program

GW: groundwater

HSA: hollow stem auger

LDW: Lower Duwamish Waterway

MW: monitoring well

n/a: not applicable  
RFI: request for information  
RI: remedial investigation  
RM: river mile  
SPT: standard penetration test  
USACE: US Army Corps of Engineers



## Appendix G – Geotechnical Design Analysis

### Attachment G.4 Calculations

---

$H_0$  0.26 ft  
 $H$  5.00 ft  
 $M$  0.05

Slope 2 H:1V  
 $\beta$  26.57 degrees  
 $c_b$  200.00 psf

submerged  $\gamma$  38 pcf  
intertidal  $\gamma$  69 pcf

$N$  6.5

submerged  $F$  6.50  
intertidal  $F$  3.58

EM 1110-2-1902  
31 Oct 03

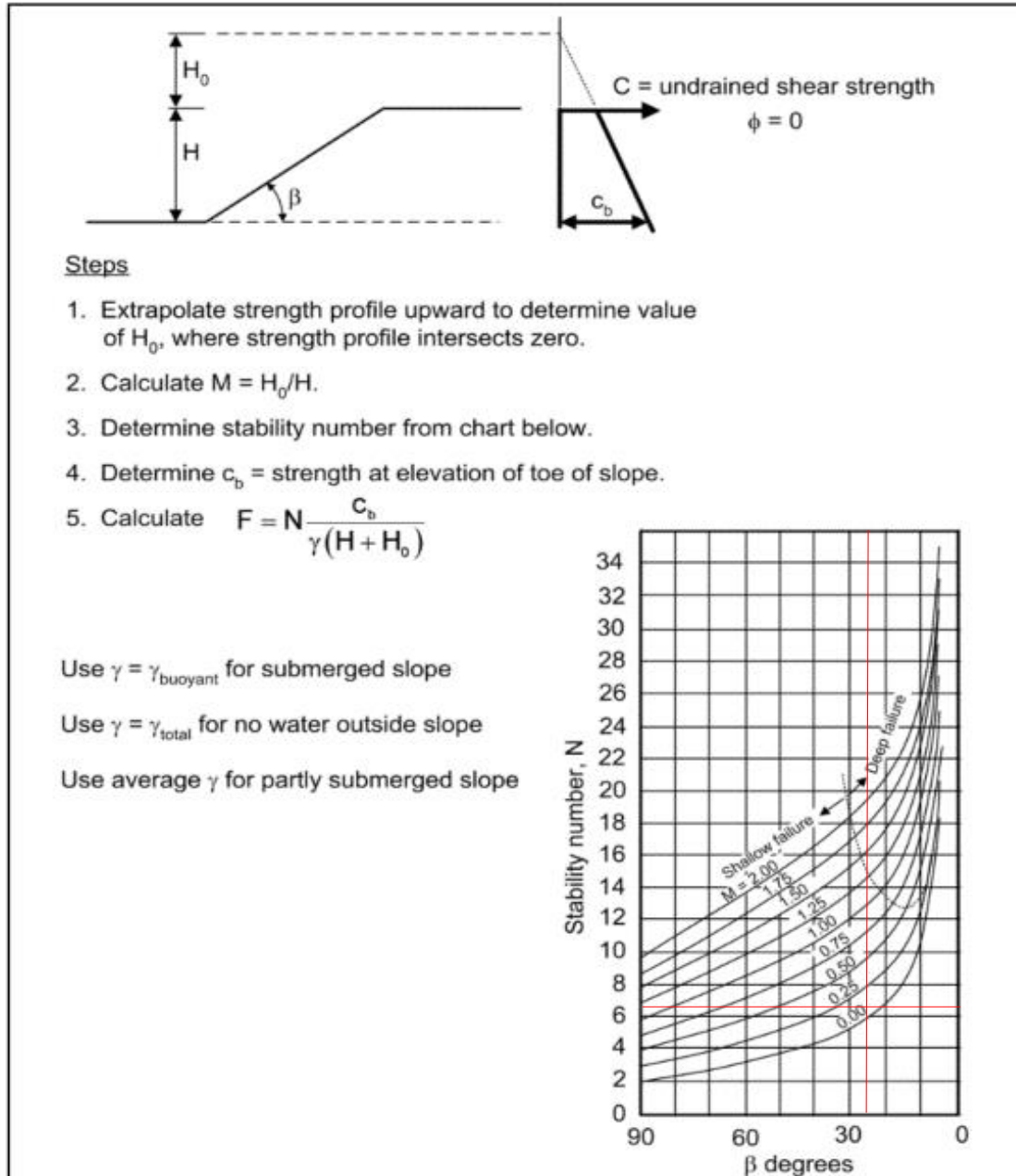


Figure E-8. Slope stability chart for  $\phi = 0$  soils, with strength increasing with depth (after Hunter and Schuster 1968)

Ref: EM 1110-2-1902 Appendix E

$H_0$  0.26 ft  
 $H$  7.00 ft  
 $M$  0.04

Slope 2 H:1V  
 $\beta$  26.57 degrees  
 $c_b$  200.00 psf

submerged  $\gamma$  38 pcf  
intertidal  $\gamma$  69 pcf

$N$  6.25

submerged  $F$  4.53  
intertidal  $F$  2.49

EM 1110-2-1902  
31 Oct 03

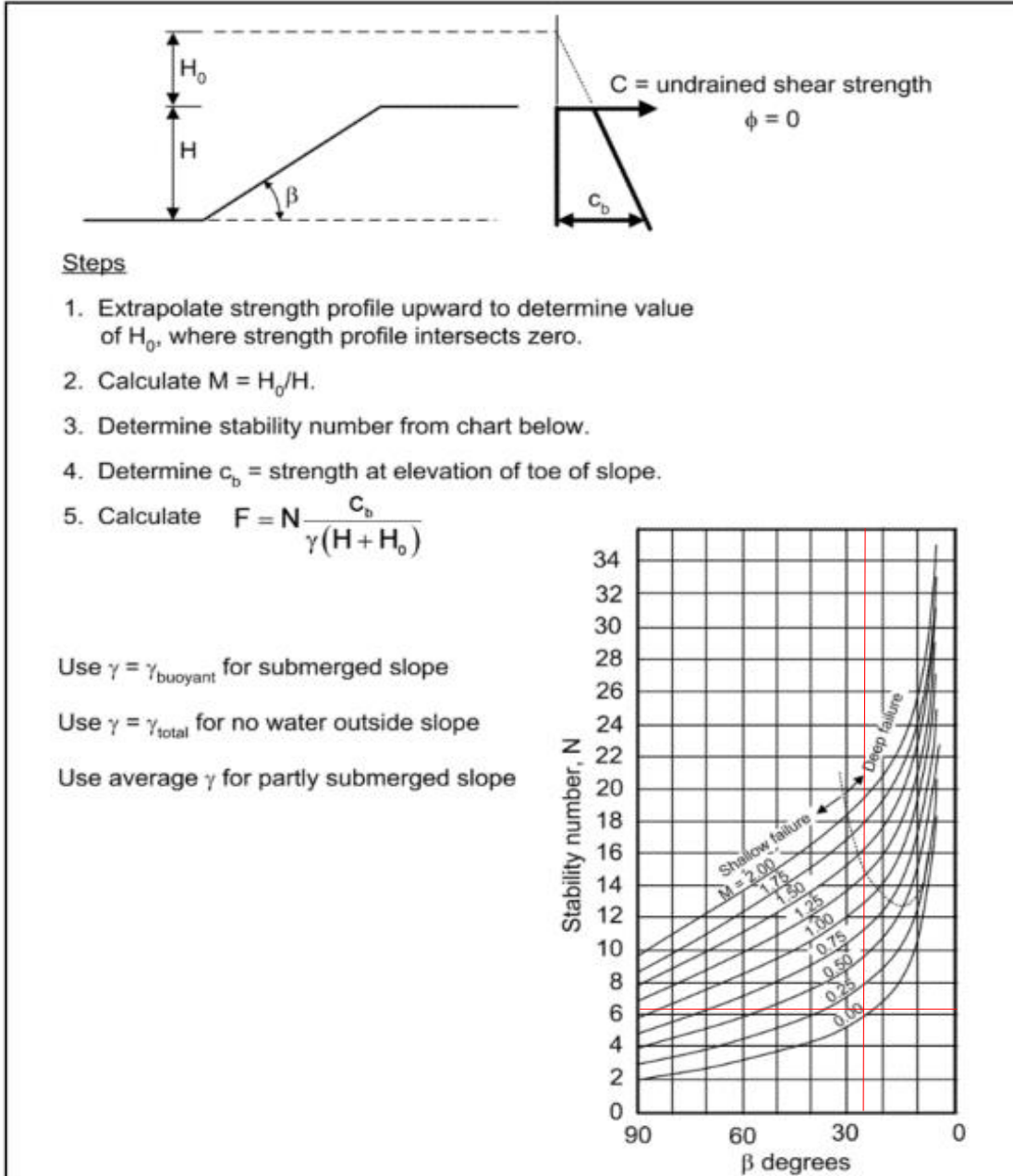


Figure E-8. Slope stability chart for  $\phi = 0$  soils, with strength increasing with depth (after Hunter and Schuster 1968)

$H_0$  0.26 ft  
 $H$  5.00 ft  
 $M$  0.05

Slope 3 H:1V  
 $\beta$  18.43 degrees  
 $c_b$  200.00 psf

submerged  $\gamma$  38 pcf  
intertidal  $\gamma$  69 pcf

$N$  8.5

submerged  $F$  8.50  
intertidal  $F$  4.68

EM 1110-2-1902  
31 Oct 03

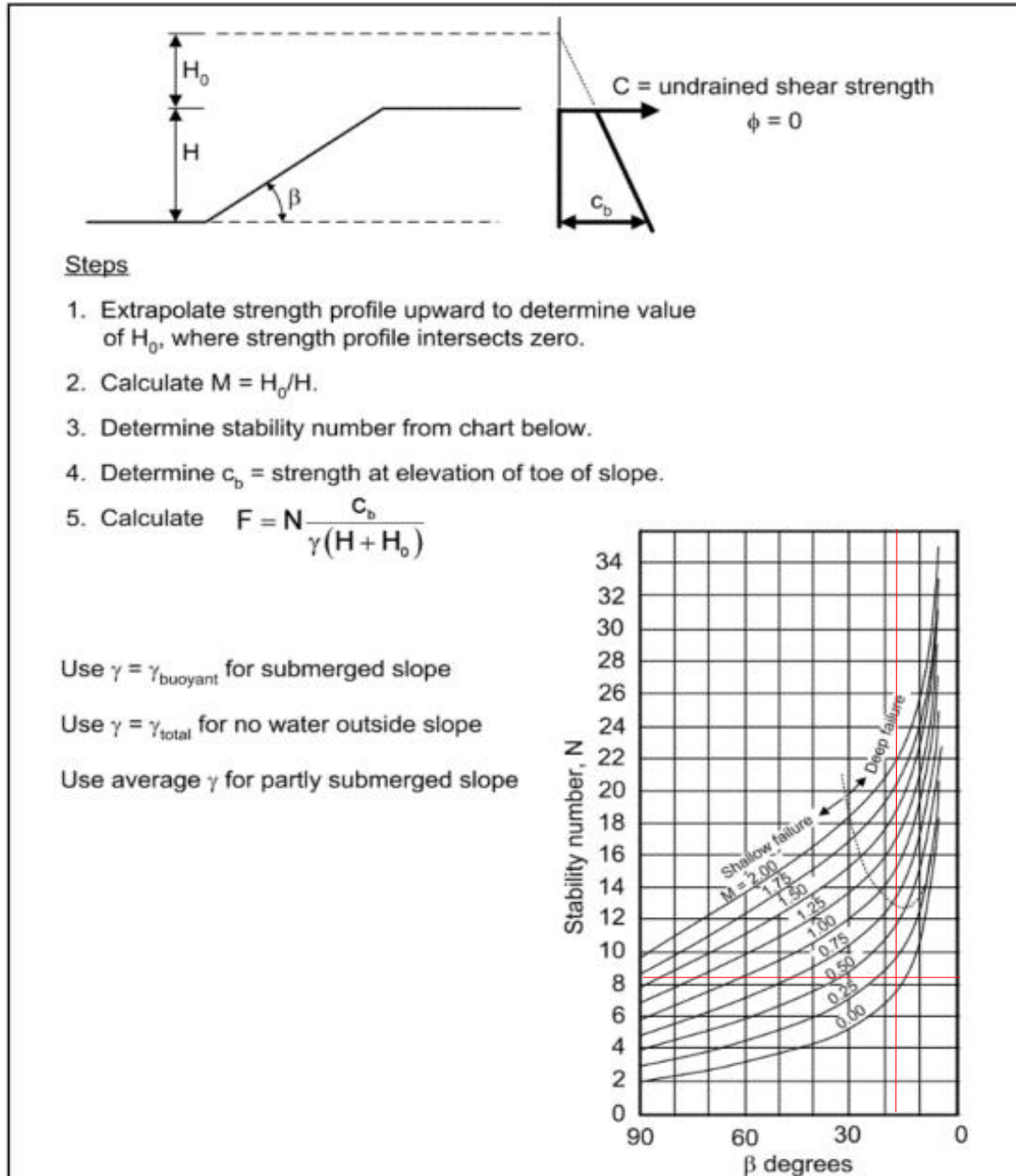


Figure E-8. Slope stability chart for  $\phi = 0$  soils, with strength increasing with depth (after Hunter and Schuster 1968)

$H_0$  0.26 ft  
 $H$  7.00 ft  
 $M$  0.04

Slope 3 H:1V  
 $\beta$  18.43 degrees  
 $c_b$  200.00 psf

submerged  $\gamma$  38 pcf  
intertidal  $\gamma$  69 pcf

$N$  8

submerged  $F$  5.80  
intertidal  $F$  3.19

EM 1110-2-1902  
31 Oct 03

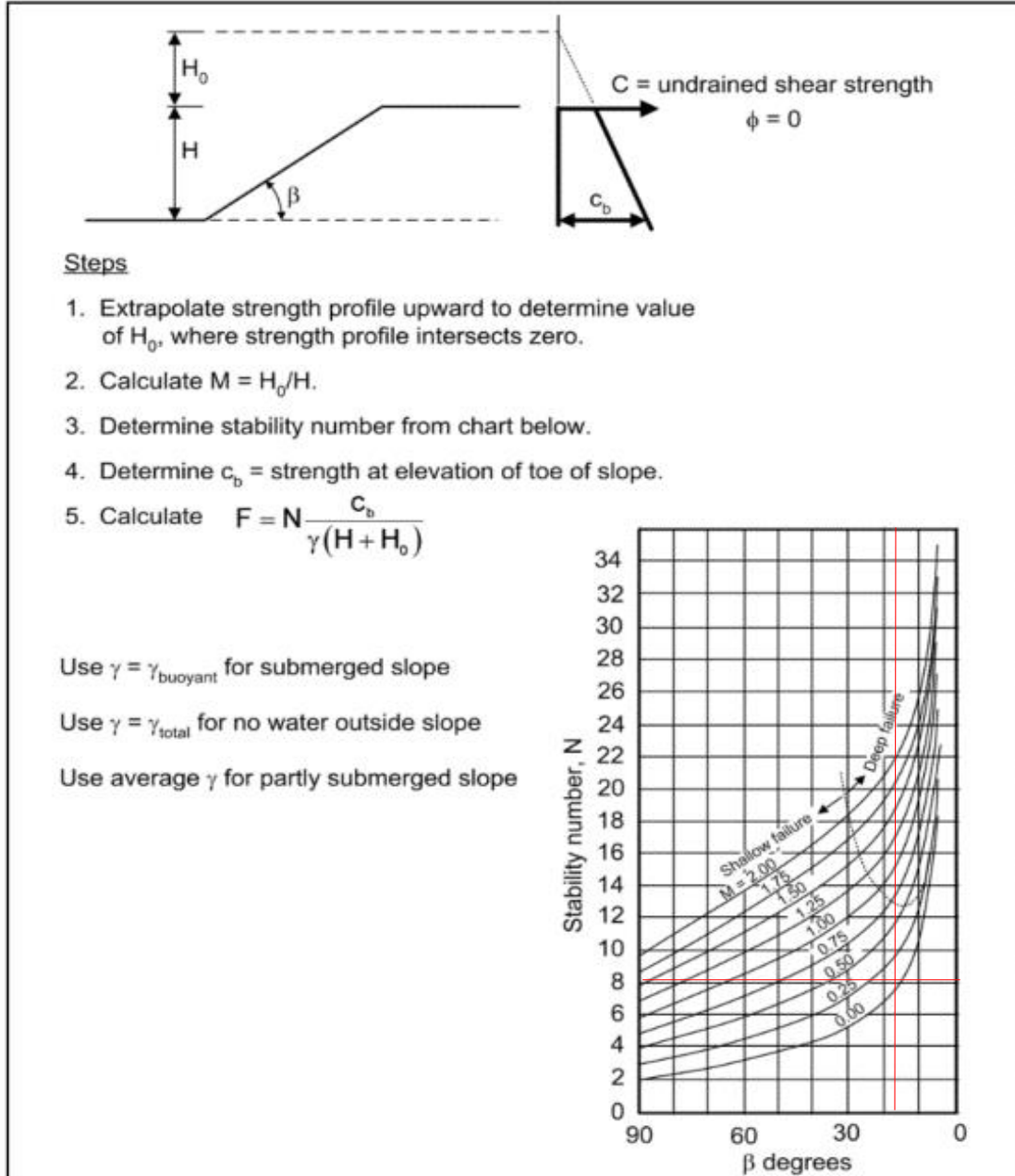


Figure E-8. Slope stability chart for  $\phi = 0$  soils, with strength increasing with depth (after Hunter and Schuster 1968)